



VoIP

AP-MG3800 Next Generation Media Gateway



Technical Sales and Marketing

AddPac Technology

www.addpac.com

AP-MG3800 Next Generation Media Gateway

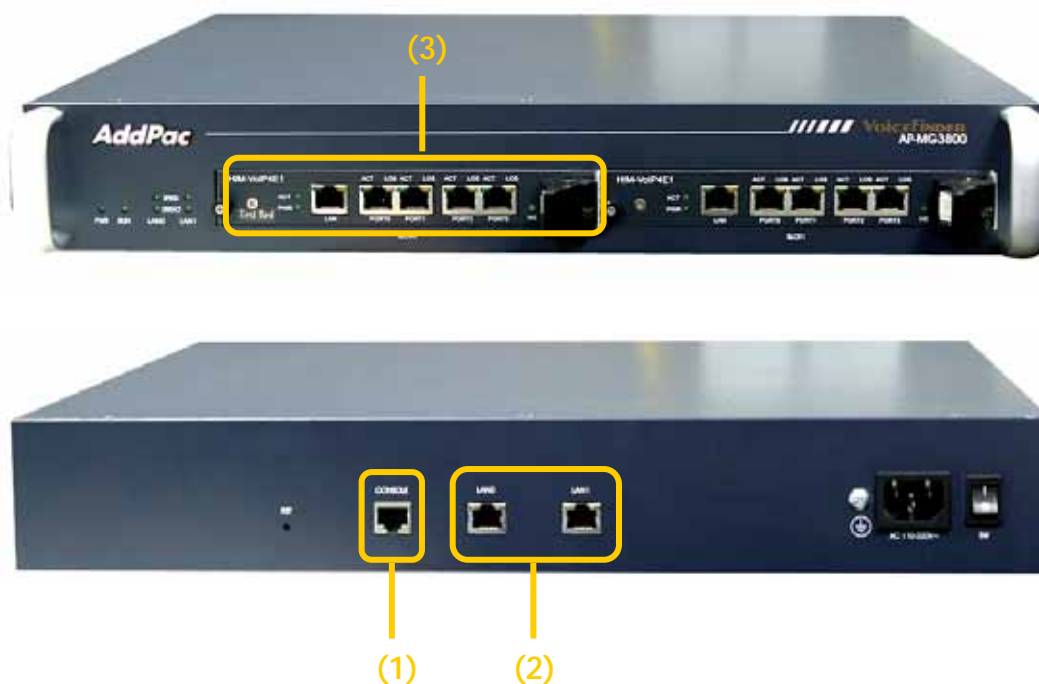

No.	Interface	Explanation
(1)	Asynchronous Serial	One(1) RS-232C serial ports for Local system management
(2)	Gigabit Ethernet	Two(2) 10/100/1000Mbps Gigabit Ethernet Ports for LAN interface
(3)	Module Slot 0-1	Four(4) Digital E1/T1 Interface, One(1) 10/100Mbps Fast Ethernet

AP-MG3800 Media Gateway Product Overview

APOS Internetworking Protocol Stack

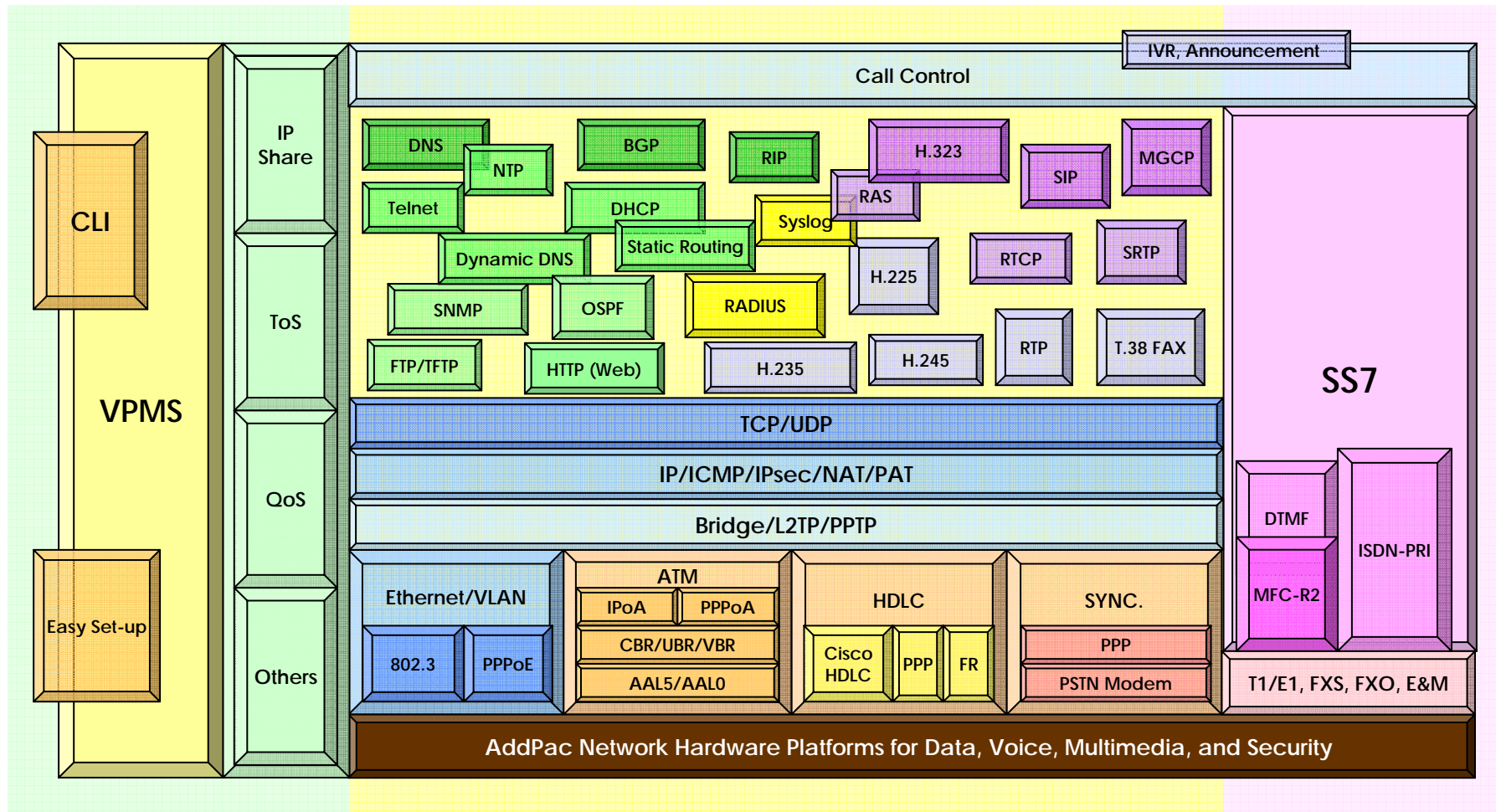

AP-MG3800 Media Gateway Product Overview

APOS Internetworking S/W World

• APOS Internetworking Software World

- AddPac Operating System (APOS)
- Support Industry Standard
- Integrated Networking Protocols
- Optimized Performance & Functionality
- Easy to use, Installation, and Maintenance

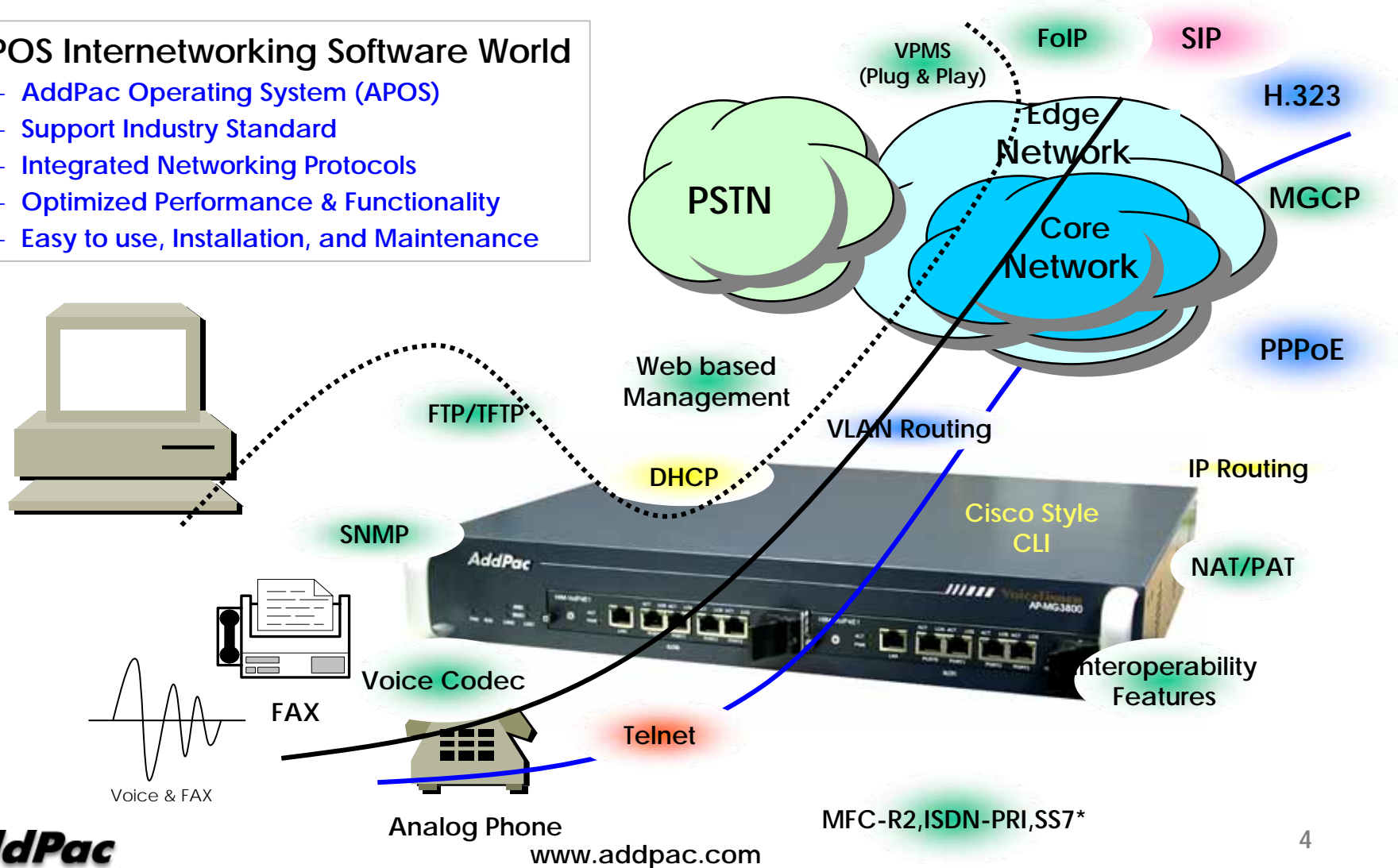

AP-MG3800 Media Gateway Product Overview

APOS Internetworking S/W World (cont.)

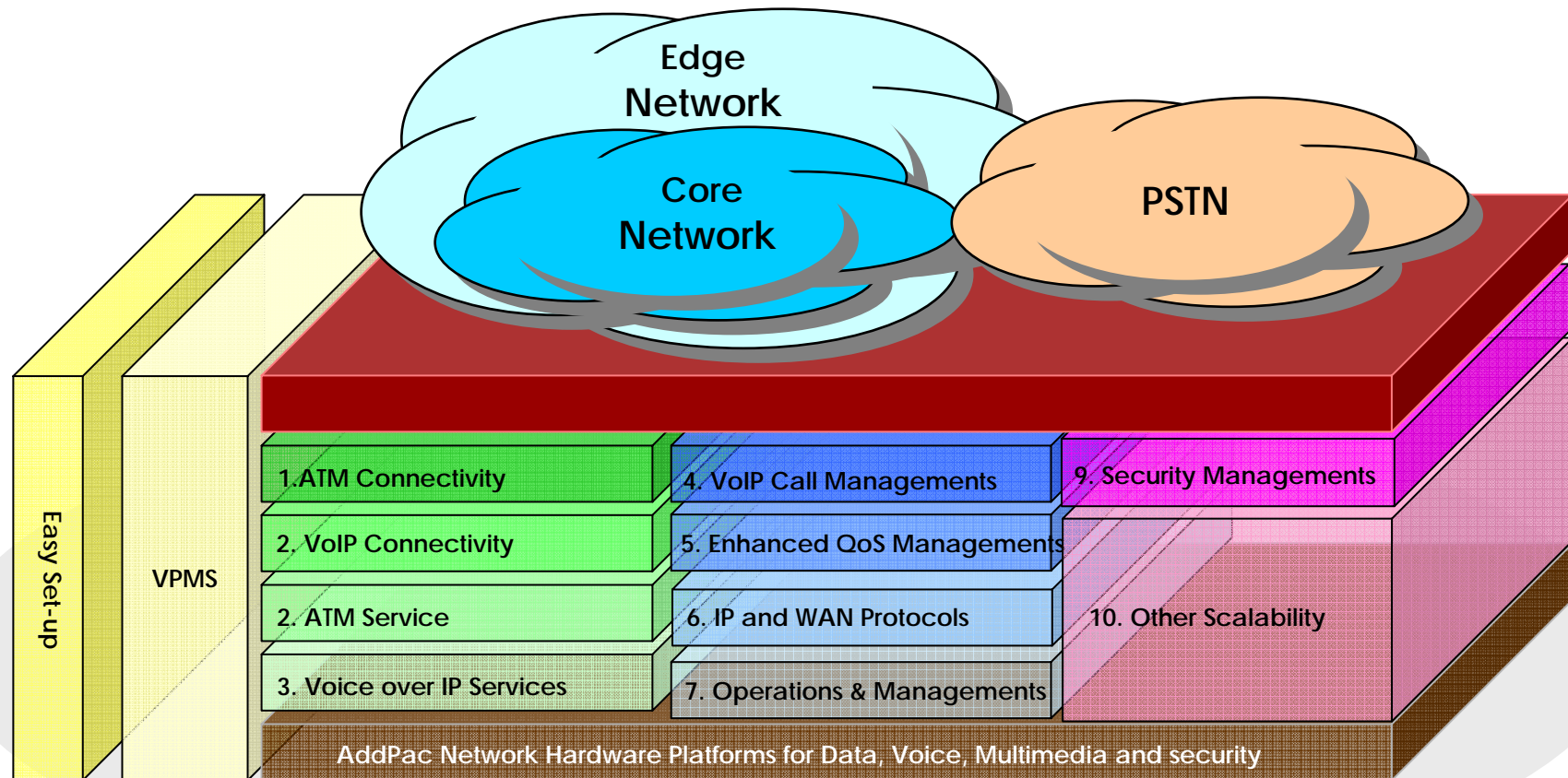

AP-MG3800 Media Gateway Product Overview

Digital E1/T1 Interface Connectivity

- E1/T1

- ISDN PRI signaling support (network mode, user mode)
- R2 signaling support (calling number receive support)
- DTMF signaling support
- Clock source master mode, slave mode support
- In case of channel allocation, ascending / descending random support
- One physical E1/T1 interface can be divided into several logical channel groups
- Super frame, extended super frame T1 framing support
- AMI, AMI-BELL, AMI-GTE, AMI-DDS, B8ZS T1 line code support
- Immediate, Wink-start T1 CAS type support
- SS7*

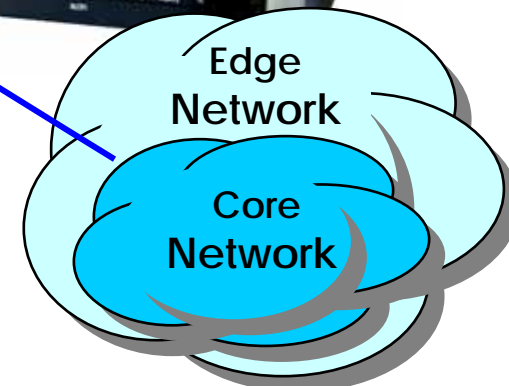
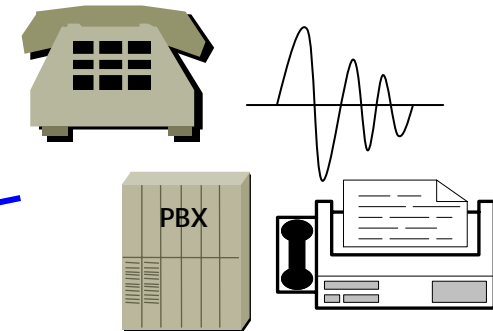

AP-MG3800 Media Gateway Product Overview

Voice over IP Service

- H.323, SIP, and MGCP Triple Stack
 - Concurrent Triple VoIP Stack Software
 - Single Hardware with Three VoIP Service
 - New APOS-NX Version
- H.323
 - ITU-T Standard H.323 v3 Support
 - Support H.245 Tunneling
 - Including H.235 Security Features
- SIP
 - IETF RFC3261 or RFC2543 SIP Standard
- MGCP
 - IETF RFC2705bis-02 Standard MGCP 1.0

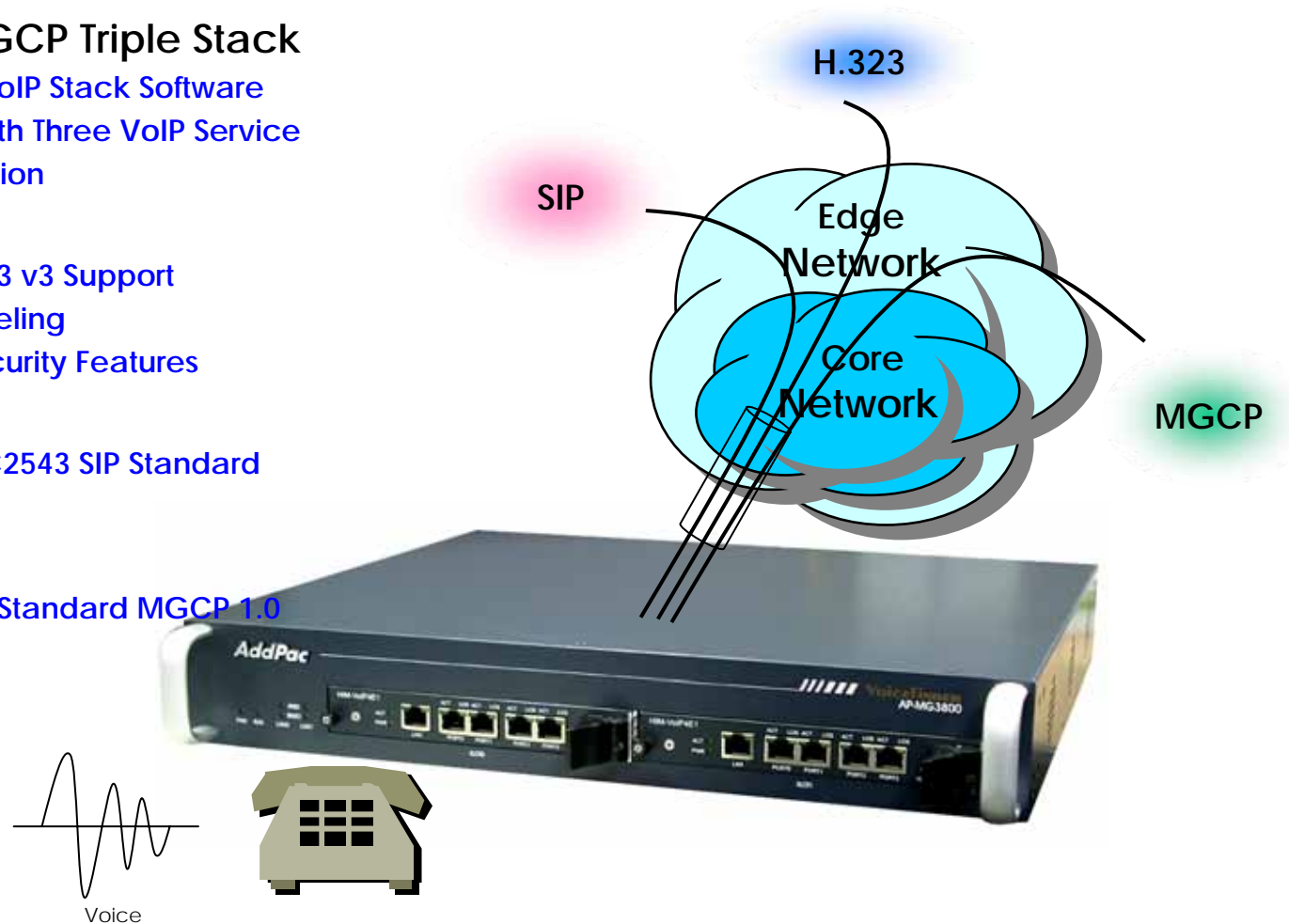

AP-MG3800 Media Gateway Product Overview

Voice over IP Service (cont.)

- H.323

- Fast connect, normal connect support
- H.245 tunneling support
- Q.931 response message setting for inbound VoIP calls
- H.245 logical channel open timing selection function
- Start H.245 procedure support
- DTMF / Hook flash relay with H.245 alphanumeric / signal
- Secondary gatekeeper support
- Gatekeeper assignment according to the domain name
- Gatekeeper discovery with multicast
- Lightweight RRQ support
- Signaling TCP port assignment
- Resource threshold setting with RAI
- H.235 clear-token, crypto-token support
- canMapAlias support
- Technical prefix (supported prefix) support
- Public IP assignment in NAT environment

- SIP

- Gateway-based / Endpoint-based registration support
- Secondary proxy-server assignment function
- SIP signaling port change function
- SIP proxy server assignment according to the domain name
- T.38 real-time fax relay support
- DTMF relay support with RFC2833 / OPTION message
- Re-INVITE support

- MGCP

- Secondary call agent assignment function
- Default package assignment
- Announcement Server Package, Generic Media Package, Handset Package, Line Package, Trunk Package support
- MGCP call agent assignment according to the domain name
- T.38 real-time fax relay support
- DTMF relay support based on RFC2833

AP-MG3800 Media Gateway Product Overview

Voice over IP Service (cont.)

• Voice Codec

- G.711 A-Law, G.711 U-Law
- G.726 r16, G.726 r32
- G.729A
- G.723.1 r63, G.723.1 r53
- VAD (Voice Activity Detection) function support
- DTMF relay support (H.323, SIP, MGCP common) based on RFC2833

• RTP

- Redundant RTP packet transmission in case of severe packet loss
- Dynamic jitter buffer management and RTP packet jitter and loss compensation with heuristic & DSP error concealment
- Static jitter buffer setting support
- Voice frame per RTP packet number control for each codec
- In-band ring-back tone support
- Virtual ring-back tone support
- Tone parameter change support

• FAX

- Fax relay mode supporting T.38, inband-T.38, bypass mode
- Lost packet compensation with redundant setting in case of T.38 fax relay
- Fax relay mode, rate setting for remote end

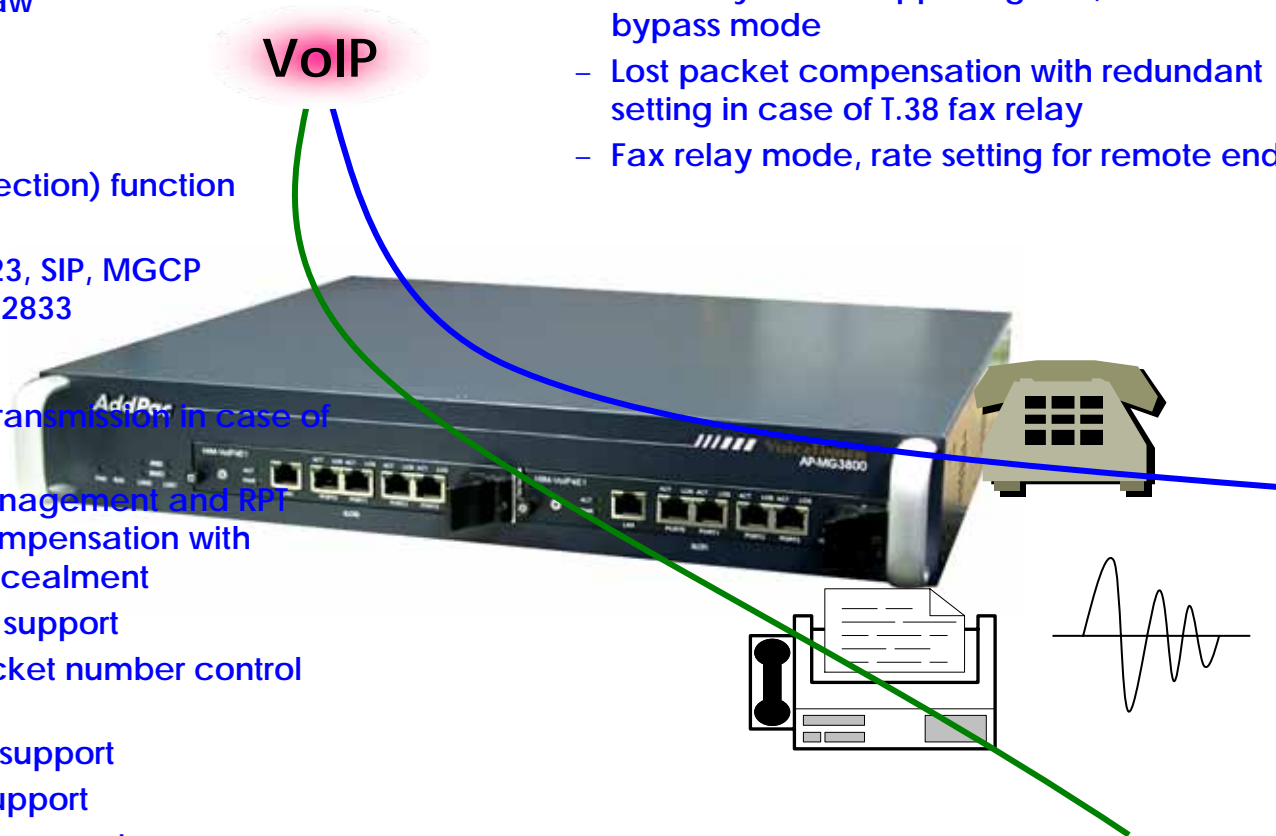

AP-MG3800 Media Gateway Product Overview

VoIP Call Managements

• VoIP Call Controls

- Hot line connection function with PLAR (Private Line Auto Ring Down)
- Leased line emulation function
- Connection monitoring function
- Fault tolerant with Redundancy and Call Distribution among Gateways for load balancing
- Call attempt with IP address
- H.323, SIP, MGCP inbound call connection for each voice port
- Multiple E.164 setting for one voice port
- One E.164 or digit pattern can be assigned to more than one voice port
- Hunting with Longest match/ priority/ sequence/ random
- One stage call setup by Digit forwarding
- Call barring with specific digit patterns
- Calling and called number conversion for PSTN outbound calls
- PSTN rerouting in case of VoIP call attempt failure

• VoIP Call Controls (cont.)

- Call transfer for internal calls
- Call pickup for internal calls
- Calling and called number conversion for VoIP outbound calls
- Calling and called number conversion for VoIP inbound calls
- Fax broadcasting call control

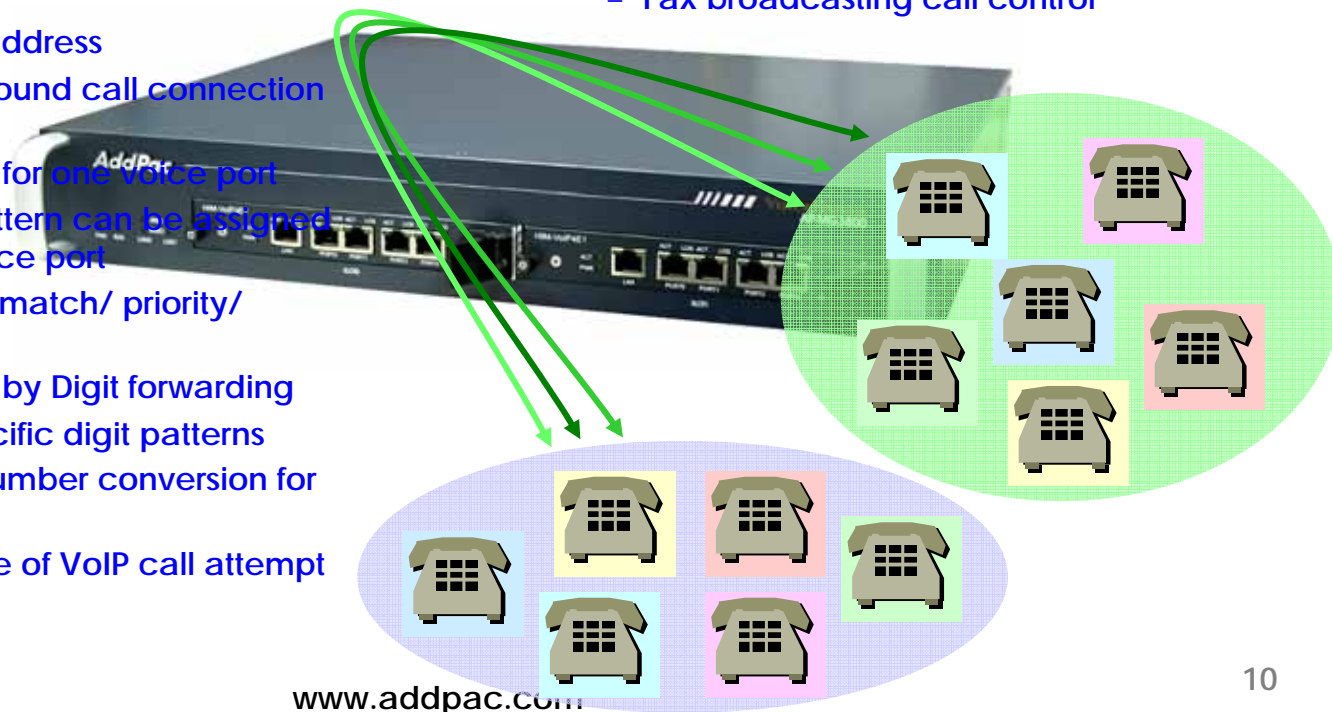

AP-MG3800 Media Gateway Product Overview

Enhances QoS Managements

- Enhances **Transmit** Voice QoS Features

- Voice Traffic Priority Queuing
- QoS Service Profiling
- Providing Virtual Network Transmit Algorithm
- Real-time Voice Traffic QoS Support
- RTP Packet Transmit Interval Control
- Supporting RTP Packet Redundancy Scheme
- IP Header Control such as ToS, Diffserv

- Enhances **Receive** Voice QoS Features

- Dynamic Jitter Buffer Management
- Error Concealment
- Support T.38 FAX Data Error Recovery Scheme

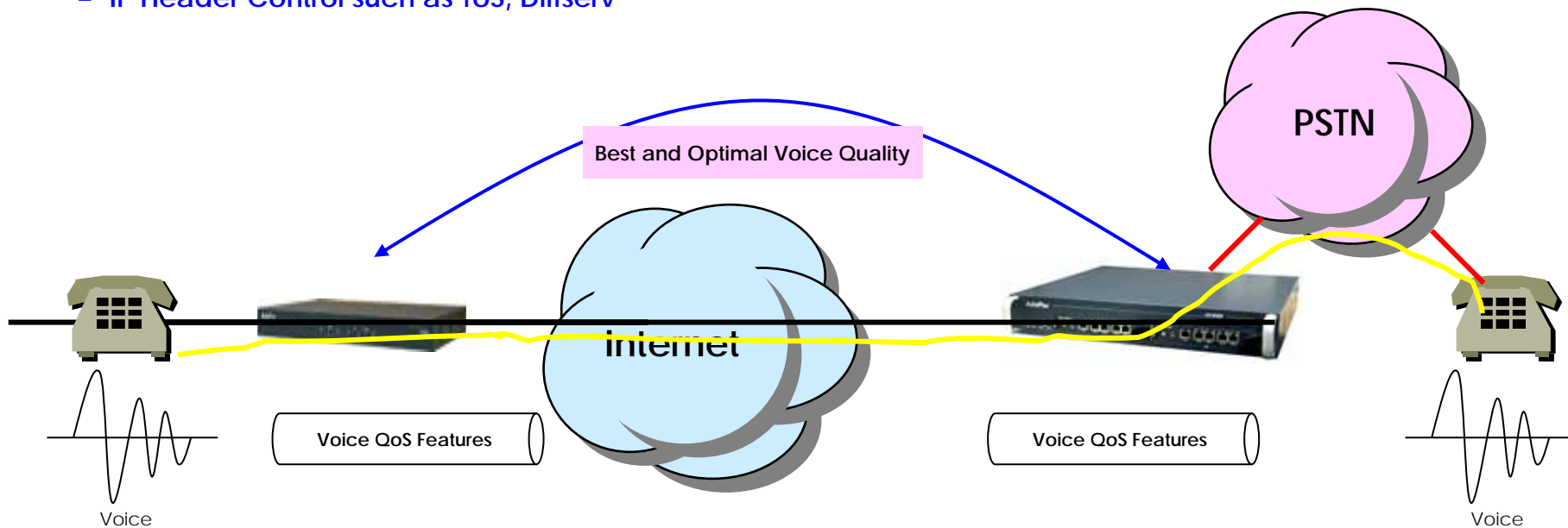

AP-MG3800 Media Gateway Product Overview

IP and WAN Protocols

- IP Routing Protocols

- Multi-protocol Internetworking Services
- Static IP routing
- RIP v1/v2 (opt.)
- OSPF v2 routing protocols support (opt.)
- Transparent Bridging (IEEE Spanning Tree Protocol)

- WAN Protocols

- Point-to-Point over Ethernet Protocol (PPPoE)

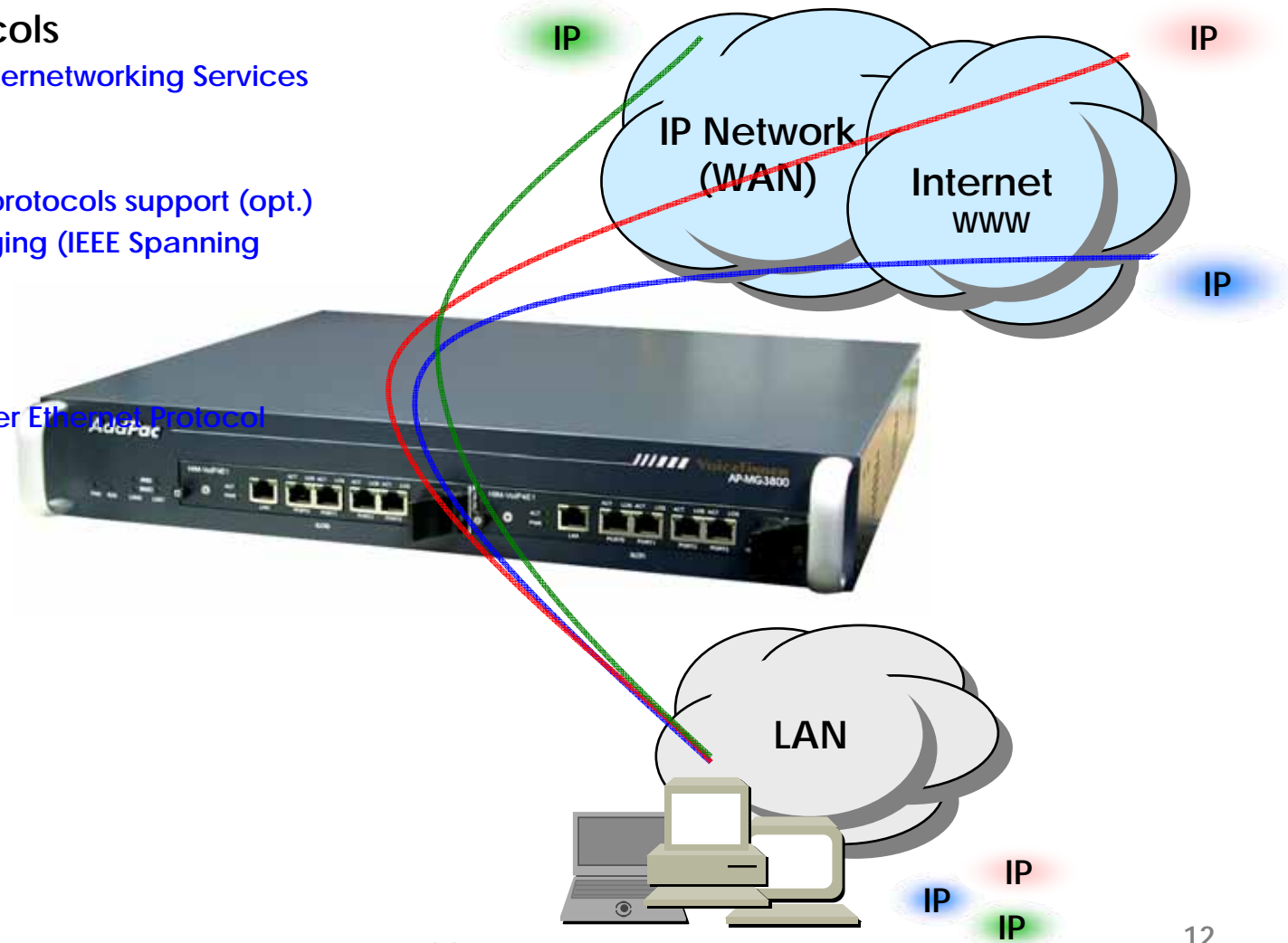

AP-MG3800 Media Gateway Product Overview

Network Managements

- **SNMP**
 - Standard Simple Network Management Protocol(SNMP) Agent support
 - MIB v1 and v2 Support
- **Web-based Management**
 - Standard Digital E1/T1 Voice Interface
- **Watch-dog Function**
 - Hardware, Software watch-dog services
- **Remote Management**
 - Telnet
 - Rlogin
 - Console
- **Auto Upgrade Service**
 - HTTP server based APOS image and configuration file auto-upgrade support
- **Batch Job Function**
 - Text based script downloading

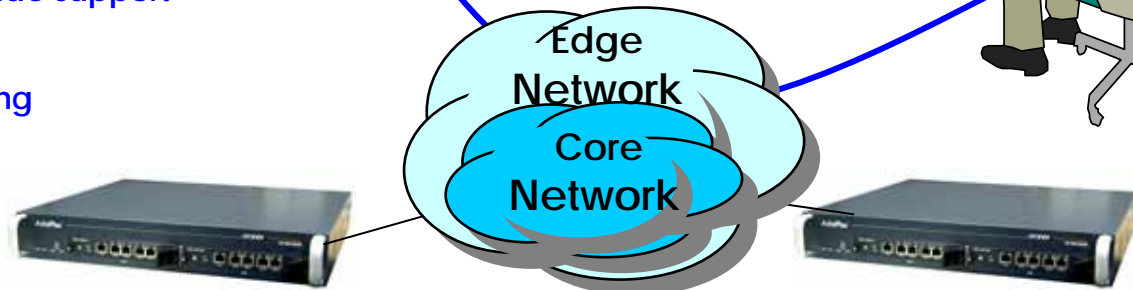
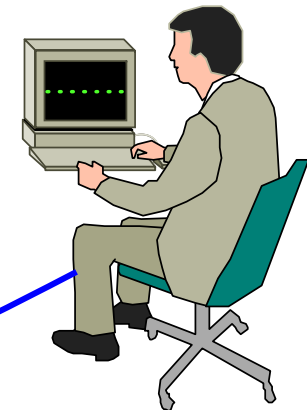

AP-MG3800 Media Gateway Product Overview

Security Managements

- IP packet filtering
- IP access list
- User authentication function
 - Password Authentication Protocol (PAP)
 - Challenge Handshake Authentication Protocol (CHAP)
- Enable/Disable specific protocols
- Auto-square connect of console and Telnet session
- Account Management function for multi-level user
- SNMP/TELNET/FTP/HTTP/TFTP port assignment function
- SNMP/TELNET/FTP access list management
- Boot mode security checking function

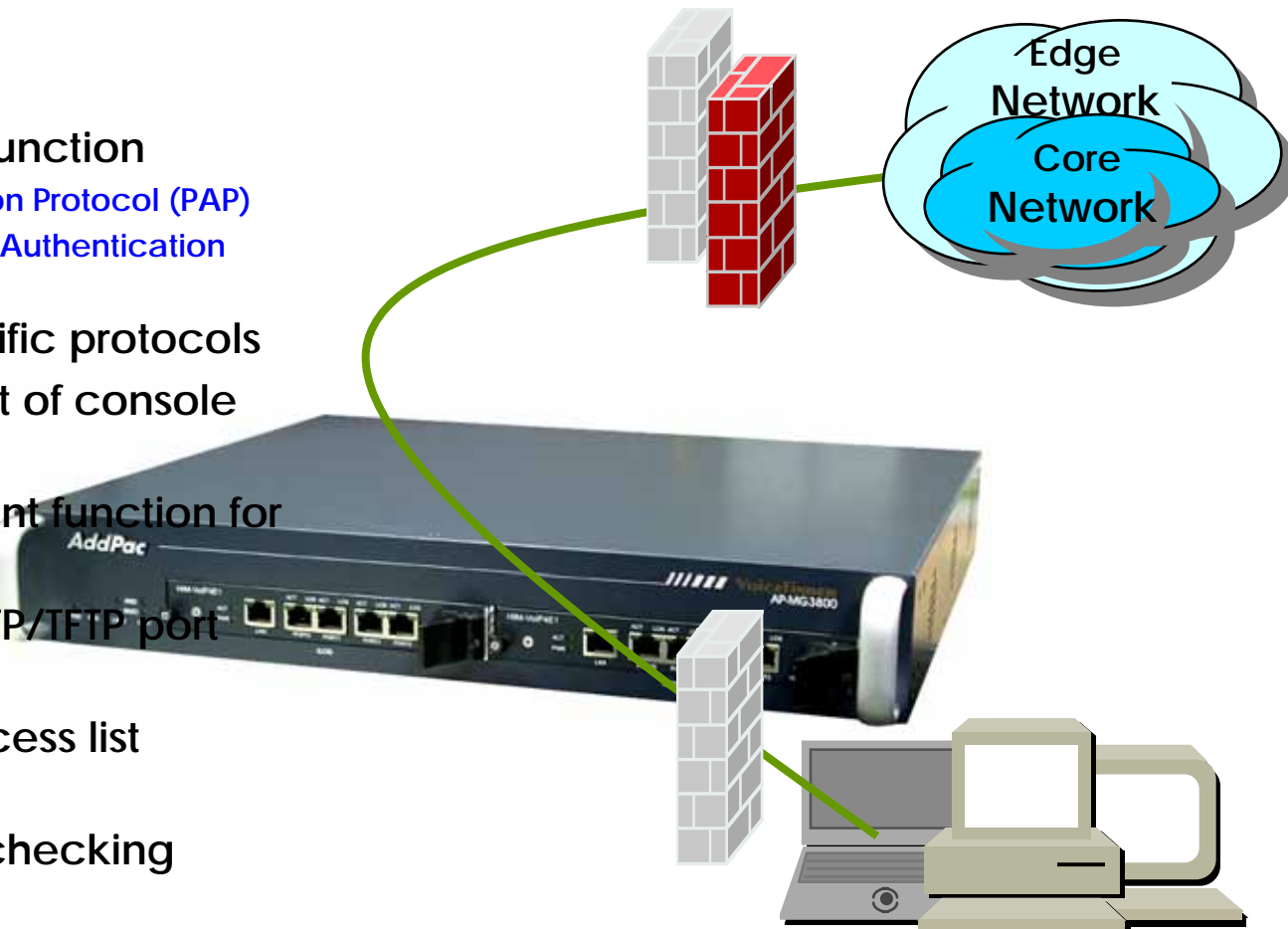

AP-MG3800 Media Gateway Product Overview

Network Scalability

- Bridging Service
 - Spanning Tree Bridging protocol (IEEE) support
- DHCP
 - Server and Relay
- IP Accounting
- PAT (Port Address Translation)
- NAT (Network Address Translation)
- Cisco Style CLI (Command Line Interface)
- PPTP (Point-to-Point Tunneling Protocol)
- NTP (Network Time Protocol)
- FTP/TFTP
 - Server and Client support
- DNS
 - Dynamic DNS Client support

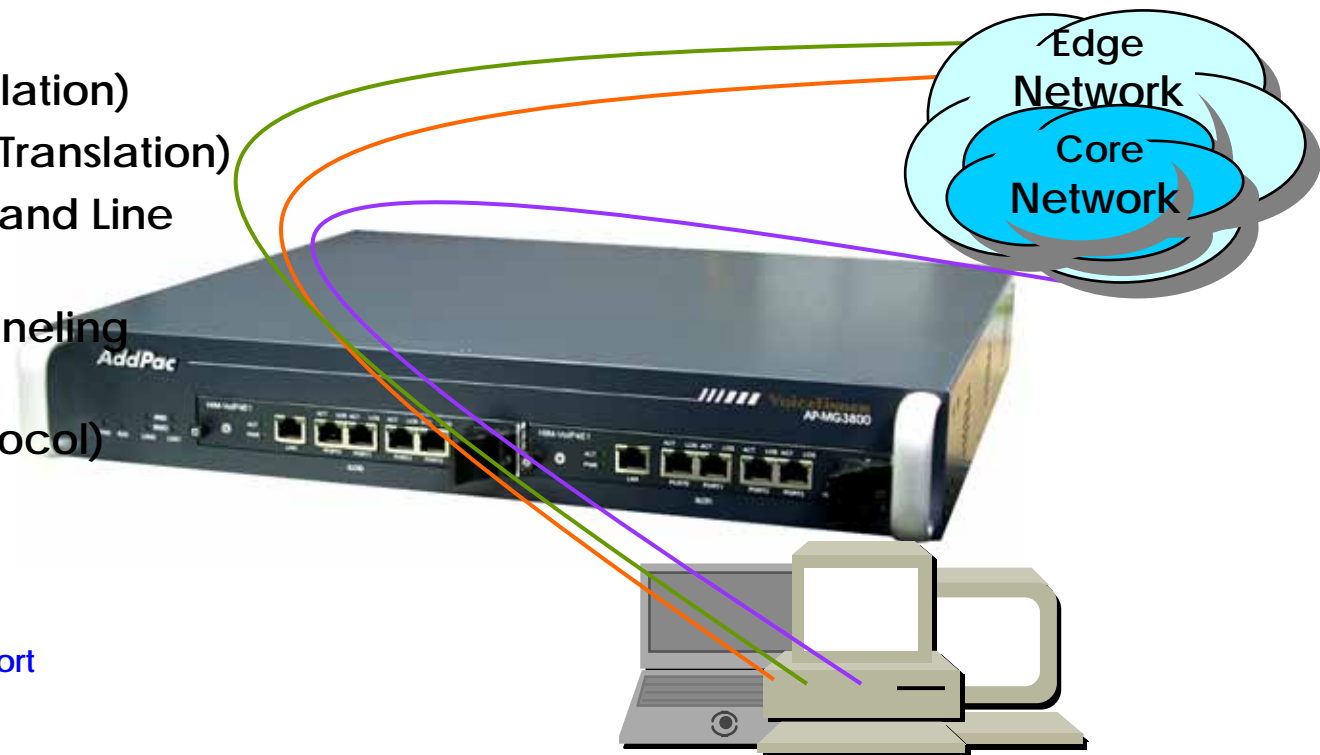

AP-MG3800 Media Gateway Product Overview

AP-MG3800 4E1/T1 Digital Voice Module

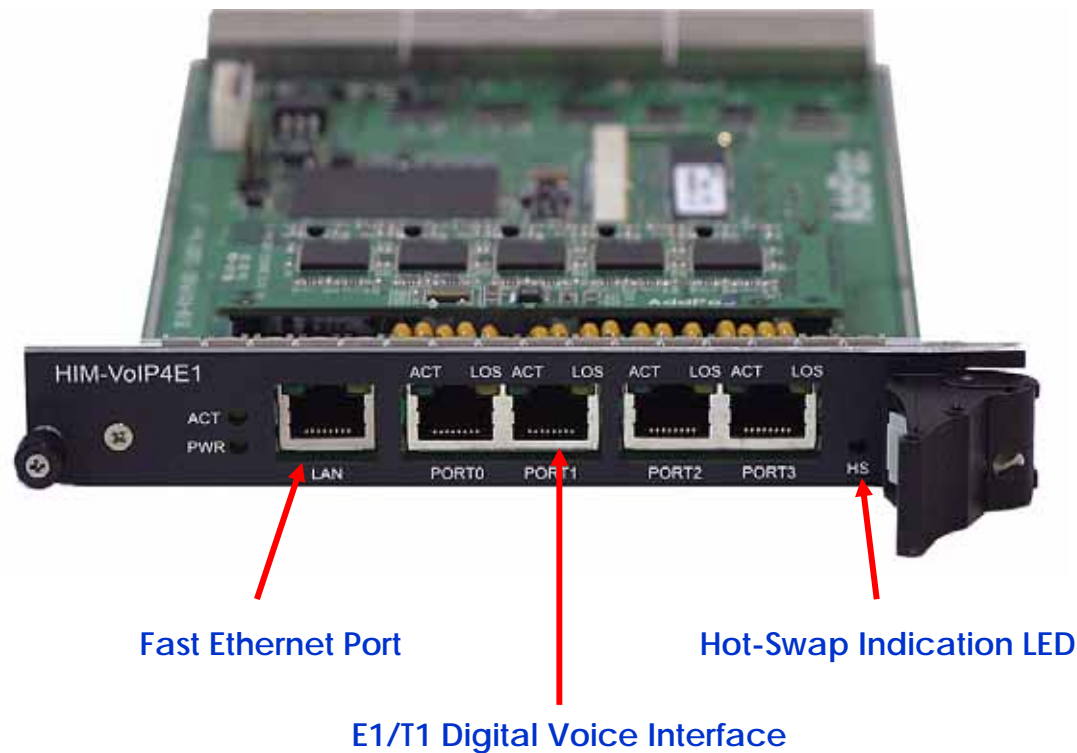

AP-MG3800 Next Generation Media Gateway

AP-MG3800 4E1 DSP Module



4E1 DSP Module	Processor	64bit Communication Microprocessor	
	Memory	SDRAM	64Mbyte High Speed SDRAM
		Boot Memory	512Kbyte Flash Memory
	Network Interface	Four(4) 10/100 Fast Ethernet Ports for LAN interface	
1-Port 10/100Mbps Fast Ethernet Interface (1 x RJ45)			

AP-MG3800 Media Gateway Product Overview

AP-MG3800 4E1/T1 Digital Voice Module

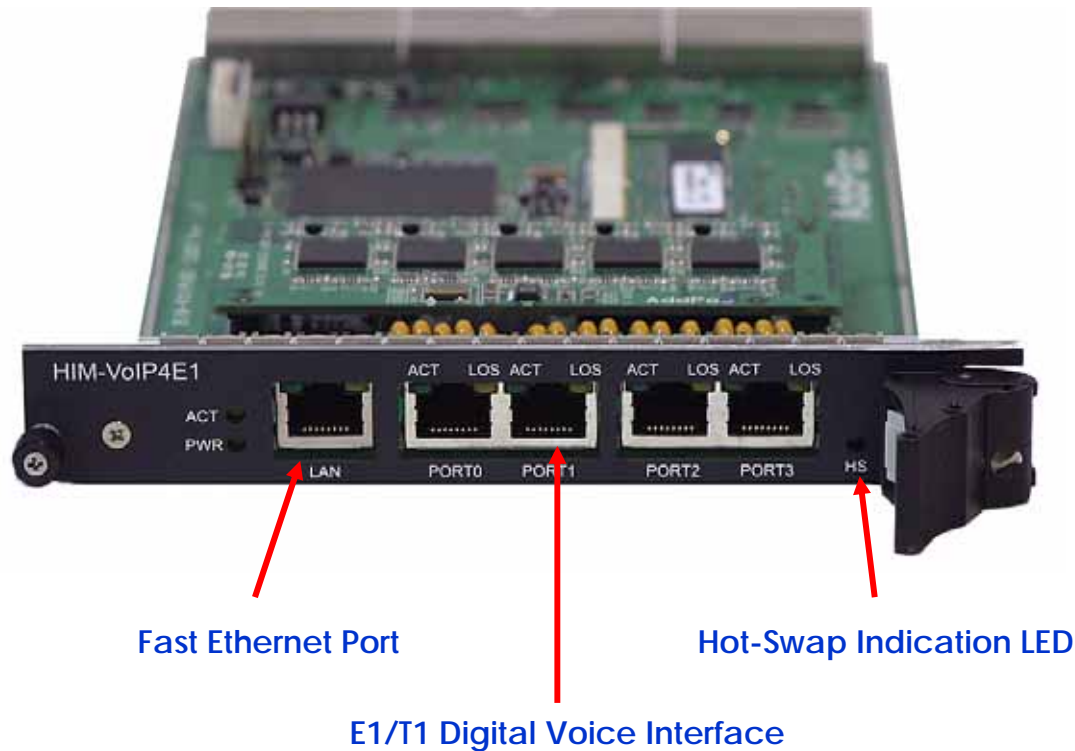

AP-MG3800 Media Gateway Product Overview

AP-MG3800 Hardware Specification



AP-MG3800 Hardware Specification				
MG3800 Main	Processor	64bit High-End Microprocessor		
	Memory	Flash Memory	16Mbyte	
		SDRAM	128Mbyte High Speed SDRAM	
		Boot Memory	512Kbyte Flash Memory	
	Network Interface	Two(2) 10/100/1000M Giga Ethernet Ports		
One(1) RS-232C serial ports for Local system management				
4E1 DSP Module	Processor	64bit Communication Microprocessor		
	Memory	SDRAM	64Mbyte High Speed SDRAM	
		Boot Memory	512Kbyte Flash Memory	
	Network Interface	Four(4)-Port E1/T1 Digital Voice Interface (4 X RJ45)		
		1-Port 10/100Mbps Fast Ethernet Interface (1 x RJ45)		
Power Input		VAC 110~220V Free Voltage, 50/60Hz		
Operating Temperature		0°C ~ 50°C		
Storage Temperature		-40°C ~ 85°C		
Width x Depth x Height		440 X 420 X 65mm -1.2Ux 19" Rack Mountable Chassis		
Weight		6.08Kg		

AP-MG3800 Voice Networking Configuration

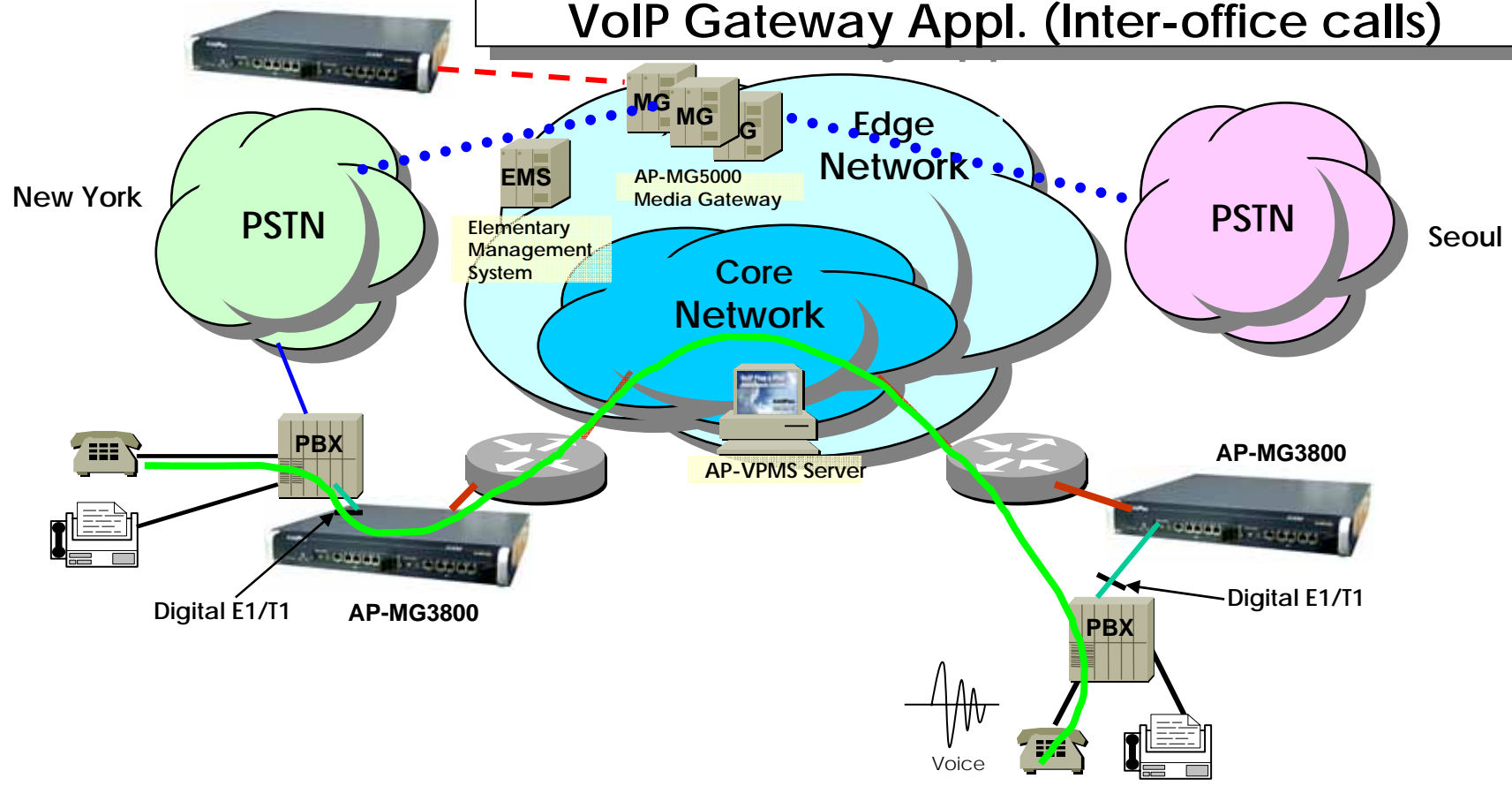
VoIP Gateway Appl. (Inter-office calls)



- Voice Call Flow
- PSTN Interface
- Voice+Data, Ethernet or WAN Interface
- TRUNK n x E1 Voice Interface for PSTN Interworking

-  Leased Line/ATM/Frame-Relay/IP Router, xDSL/Cable Modem, etc.
-  AddPac AP-MG3800 Media Gateway
-  Analog Phone

AP-MG3800 Networking Configuration

VoIP Gateway Appl. (VoIP to PSTN Inter-working Call Flow)

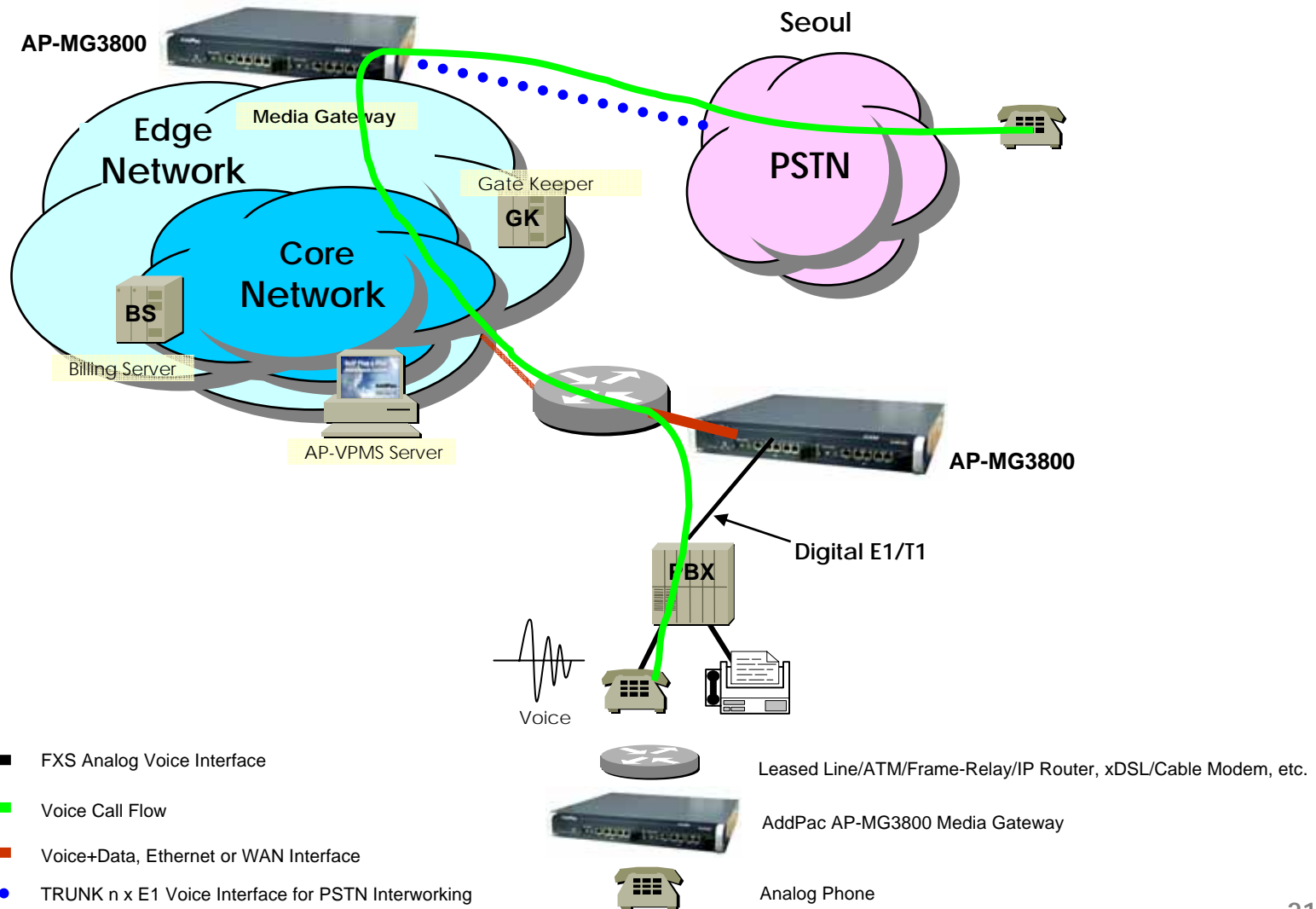

AP-MG3800 Media Gateway Product Overview

AP-MG3800 Ordering and Pricing

- AP-MG3800 Media Gateway

- AP-MG3800-01 : AP-MG3800 Standard Configuration

- Two(2) Gigabit Ethernet Interface
 - One(1) RJ45 Console Port
 - 64bit RISC CPU, 16MB Flash, 128MB SDRAM
 - APOS v5.xx with Operation Manual
 - Including CAB-LAN, CAB-CON

MG3800-4E1 : 4 Port Digital E1 Interface Module

MG3800-4T1 : 4 Port Digital T1 Interface Module

CAB-LAN :RJ45 Ethernet Cable

CAB-CON :RJ45 RS-232C Console Cable



AP-MG3800 Media Gateway Product Overview

AP-MG3800 Comparison Table

	<p align="center">AP-MG3800 Media Gateway</p>
<p>▶ Digital 4E1 /T1 VoIP Module</p>	<p align="center">Up to 2</p>
<p>▶ 10/100/1000 Mbps Ethernet Ports</p>	<p align="center">2</p>
<p>▶ Console Port</p>	<p align="center">1</p>
<p>▶ Main CPU</p>	<p align="center">High-End Power PC 64Bit RISC</p>
<p>▶ Main Flash Memory</p>	<p align="center">16Mbyte</p>
<p>▶ Main Memory</p>	<p align="center">128Mbyte</p>
<p>▶ Internetworking OS</p>	<p align="center">APOS</p>
<p>▶ H.323, SIP, MGCP VoIP Protocol, T38 FAX</p>	<p align="center">YES</p>
<p>▶ PPPoE, PPTP Network Protocols</p>	<p align="center">YES</p>
<p>▶ Enhanced QoS Management Feature</p>	<p align="center">YES</p>
<p>▶ IP Routing Protocols Including NAT</p>	<p align="center">YES</p>

Thank you !

www.addpac.com