



# AP-GS1002

## 2-Port FXS GSM Gateway

High Performance GSM Gateway Solution

### Preliminary Product Overview

(Without notice, following described technical spec. can be changed)

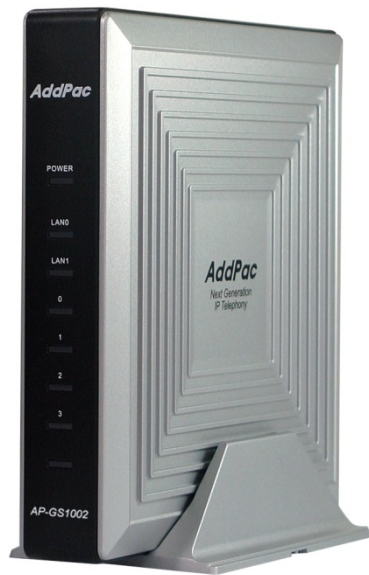

**AddPac**

**AddPac Technology**

Sales and Marketing

[www.addpac.com](http://www.addpac.com)

# Contents

## AP-GS1002 2-Port FXS GSM Gateway

- Product Overview
- Hardware Specification
- GSM Module Specification
- APOS Technology
- VoIP (Voice over IP) service
- Advanced QoS Features
- Network Protocols
- Network Management
- Smart Web Management
- Security Management
- Application Service
- Ordering Information

# Product Overview

## AP-GS1002 2-Port FXS GSM Gateway

- Analog Interface (FXS)/VoIP Interface(LAN) Both Support
- H.323/SIP/MGCP Triple Concurrent Stack Embedded
- High Performance RISC & Programmable DSP Architecture
- Two(2) 10/100Mbps Fast Ethernet (IP Share ,etc)
- High Performance LAN-to-LAN Routing Capability
- G.711/G.726/G.723/G.729, T.38 Fax , VAD, etc
- Powerful Network Protocols (PPPoE, DHCP, Static Routing, etc)
- Firmware Upgradeable Architecture
- VPMS (VoIP Plug&Play Management System) for Large Scale Deployment
- Advanced Voice QoS Mechanism
- Light and Compact Design with External Power Supply

# Product Highlights

AP-GS1002 2-Port FXS GSM Gateway

## Powerful GSM Gateway

State-of-art Signaling  
H.323, SIP, MGCP  
Concurrent Triple Stack

Light and  
Compact Design

Analog FXS interface,  
VoIP Interface Both  
Support

High Performance RISC CPU  
+ Programmable DSP

Excellent Voice Quality  
G.729/G.723/G726/G711

Broadband IP Networking  
With dual 10/100Mbps  
Fast Ethernet

APOS™ Technology  
Firmware Upgradeable Architecture

VPMS Large Scale VoIP  
Gateway Management Support

Powerful Network Protocol  
Support

Powerful Trouble Shooting &  
Debugging Feature Support

Advanced Voice  
Traffic QoS Mechanism

**AddPac**

[www.addpac.com](http://www.addpac.com)

# APOS Technology

AP-GS1002 2-Port FXS GSM Gateway



- APOS : AddPac Internetworking Operating System
- OSD : On- Screen Display
- EMS : Element Management System

# Hardware Specification

AP-GS1002 2-Port FXS GSM Gateway

RISC  
CPU

High-end  
DSP

- **RISC Microprocessor Computing Power**
- **2-Port FXS GSM Gateway**
- **2-Port SIM Card Slot**
- **2-Port GSM Antenna Interface**
- **Network Interface for VoIP Direct Interface**
  - Two(2) 10/100Mbps Fast Ethernet (RJ45)
- **RS232C Console Interface for CLI**
- **Run LED, LAN LED, Port LEDs**
- **External Power Supply**

# Hardware Specification

AP-GS1002 2-Port FXS GSM Gateway

RISC  
CPU

High-end  
DSP

## GSM Gateway Service Diagram

AP-GS1002 GSM Gateway Internal H/W Block Diagram

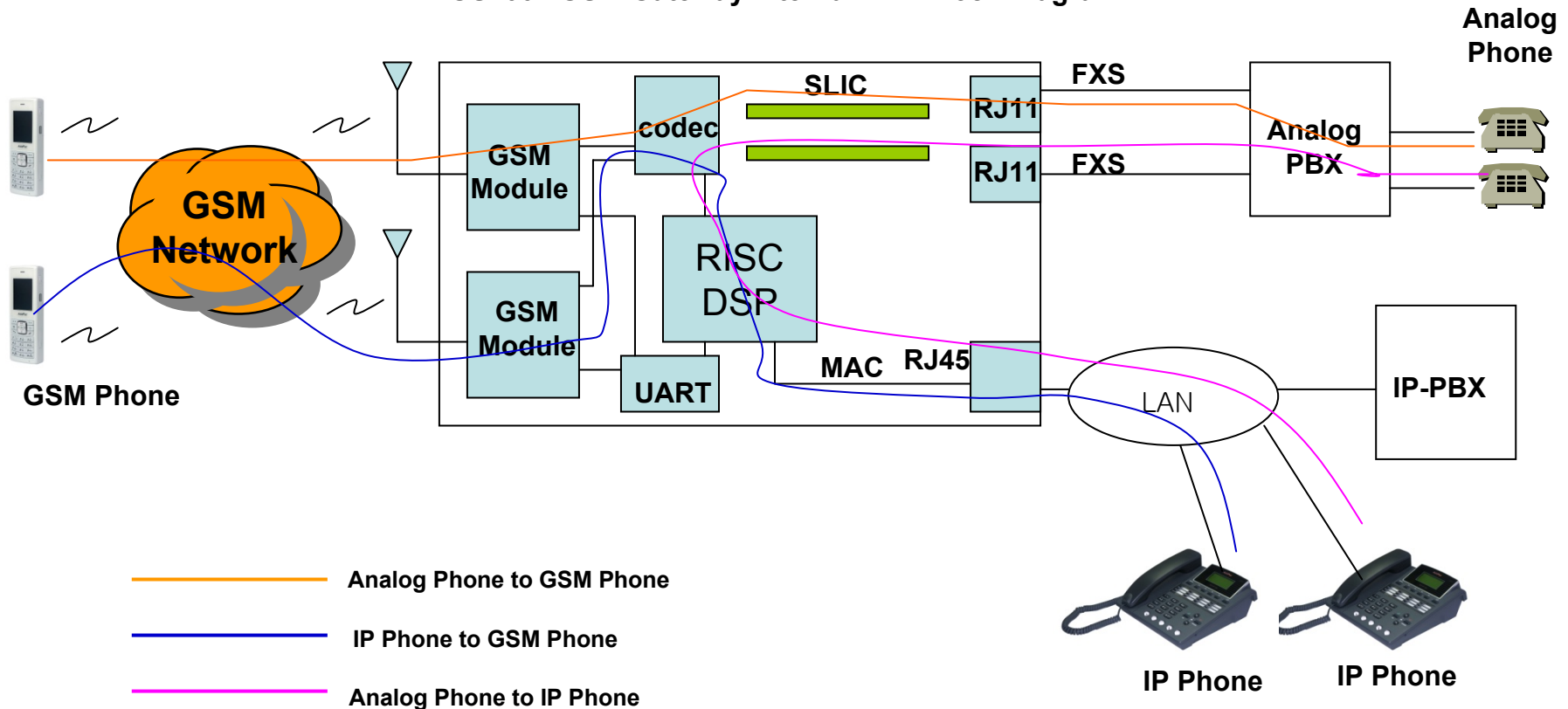

# Hardware Specification

## AP-GS1002 2-Port FXS GSM Gateway

### Hardware Specifications

AP-GS1002 2-Port FXS GSM Gateway	Basic Specifications
Analog Interface	Two(2)-Port FXS Analog Interface
GSM Antenna Interface	External GSM Antenna
SIM Card Slot Interface	GSM SIM Card Slot
Ethernet Interface	2-Ports 10/100Mbps Ethernet Interface(RJ-45) for
Flash Memory	4Mbyte High-speed Flash Memory
Base Memory	32 Mbyte High-speed SDRAM
Power Requirement	Power Supply Adaptor / VAC 110~220V, 50/60Hz, 5V, 3A
Operating Temperature	0°C ~ 45°C (32 °F ~ 122°F)
Storage Temperature	-40°C ~ 85°C (-40°C ~ 185°F)
Relative Humidity	5% ~ 95% (Non-condensing)
Dimensions	182mm x 182mm x 38mm (W x D x H)

### Network interface Configurations

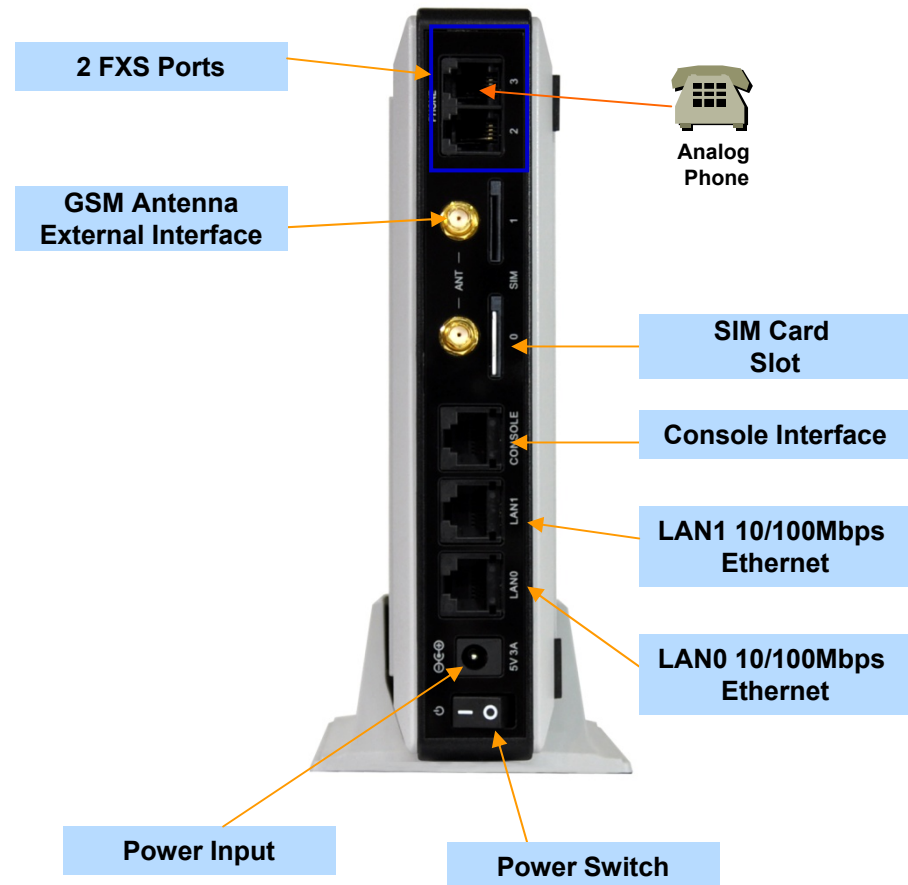



# GSM Module Specification

## AP-GS1002 2-Port FXS GSM Gateway

- Quad-Band EGSM 850/900/1800/1900MHz
- Output Power
  - Class 4[2W]@ 850/900MHz
  - Class 1[1W]@ 1800/1900MHz
- Sensitivity
  - 107dBm[typ.] @850/900MHz
  - 106dBm[typ.] @1800/1900MHz
- 50Ohm murata GSC antenna connector
- Half rate, Full rate, Enhanced full rate and Adaptive multi-rate voice codec[HR,FR,EFR,AMR]
- Superior echo cancellation & Noise reduction
- SMS, Circuit Switched Data, GPRS Data, FAX
- GSM Supplementary



# GSM Service

AP-GS1002 2-Port FXS GSM Gateway

<b>GSM Service</b>	<b>GSM two-stage dialing</b>
	<b>GSM Module Management : PIN, IMSI, Power, (No)Shutdown Setting, Up/Down Speed Display, Current Power Level Display</b>
	<b>GSM Inbound call black list &amp; white list</b>
	<b>VoIP Inbound call black list &amp; white list</b>
	<b>LCR(Least Cost Routing)-GSM Traffic Metering</b>
	<b>LCR(Least Cost Routing)-Scheduling</b>
	<b>LCR(Least Cost Routing)-Simulator</b>
	<b>GSM Messaging Service</b>
	<b>GSM SNMP : GSM Standard MIB</b>
	<b>Call Back Service at GSM Port Busy</b>

# VoIP (Voice over IP) Service

AP-GS1002 2-Port FXS GSM Gateway

- H.323, SIP, and MGCP Triple Stack
- H.323
  - ITU-T Standard H.323 v3 Support
  - Support H.245 Tunneling
  - Including H.235 Security Features
- SIP
  - IETF RFC3261 or RFC2543 SIP Standard
- MGCP
  - IETF RFC2705bis-02 Standard MGCP 1.0



# VoIP (Voice over IP) Service

## AP-GS1002 2-Port FXS GSM Gateway

- **H.323**

- Fast connect, normal connect support
- H.245 tunneling support
- Q.931 response message setting for inbound VoIP calls
- H.245 logical channel open timing selection function
- Start H.245 procedure support
- DTMF / Hook flash relay with H.245 alphanumeric / signal
- Secondary gatekeeper support
- Gatekeeper assignment according to the domain name
- Gatekeeper discovery with multicast
- Lightweight RRQ support
- Signaling TCP port assignment
- Resource threshold setting with RAI
- H.235 clear-token, crypto-token support
- canMapAlias support
- Technical prefix (supported prefix) support
- Public IP assignment in NAT environment

- **SIP**

- Gateway-based / Endpoint-based registration support
- Secondary proxy-server assignment function
- SIP signaling port change function
- SIP proxy server assignment according to the domain name
- T.38 real-time fax relay support
- DTMF relay support with RFC2833 / OPTION message
- Re-INVITE support

- **MGCP**

- Secondary call agent assignment function
- Default package assignment
- Announcement Server Package, Generic Media Package, Handset Package, Line Package, Trunk Package support
- MGCP call agent assignment according to the domain name
- T.38 real-time fax relay support
- DTMF relay support based on RFC2833

# VoIP (Voice over IP) Service

## AP-GS1002 2-Port FXS GSM Gateway

- **Voice Codec**

- G.711 A-Law, G.711 U-Law
- G.726 r16, G.726 r32
- G.729A
- G.723.1 r63, G.723.1 r53
- VAD (Voice Activity Detection) function support
- DTMF relay support (H.323, SIP, MGCP common) based on RFC2833

- **RTP**

- Redundant RTP packet transmission in case of severe packet loss
- Dynamic jitter buffer management and RTP packet jitter and loss compensation with heuristic & DSP error concealment
- Static jitter buffer setting support
- Voice frame per RTP packet number control for each codec
- In-band ring-back tone support
- Virtual ring-back tone support
- Tone parameter change support

- **FAX**

- Fax relay mode supporting T.38, inband-T.38, bypass mode
- Lost packet compensation with redundant setting in case of T.38 fax relay
- Fax relay mode, rate setting for remote end

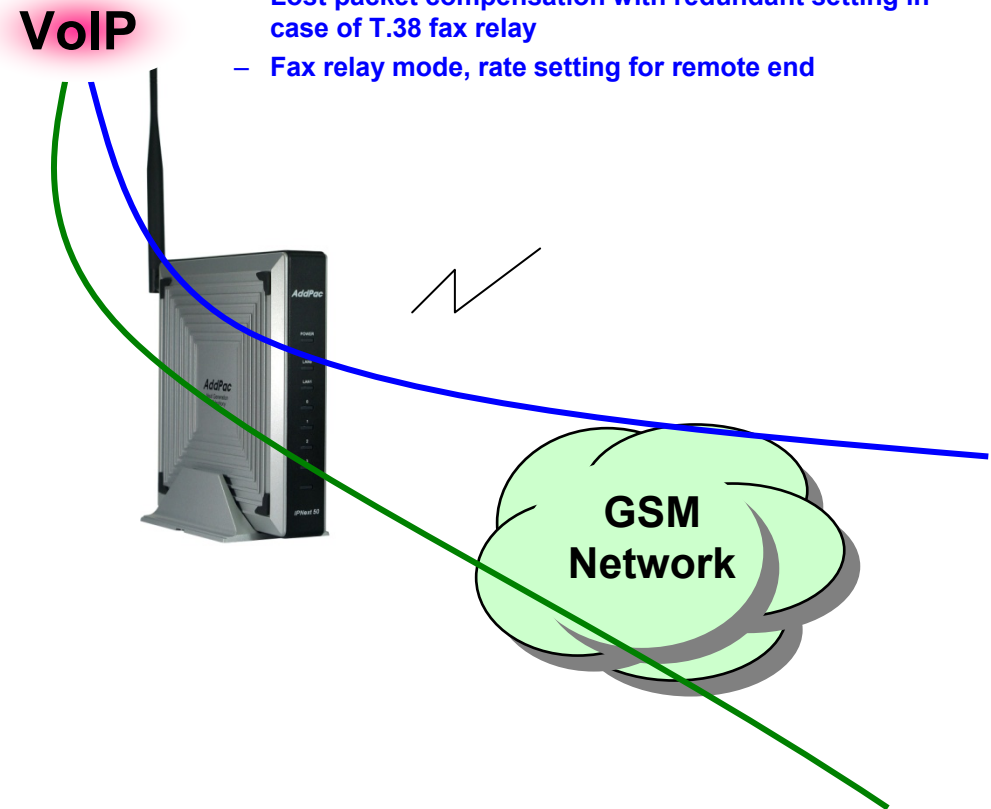

# VoIP (Voice over IP) Service

## AP-GS1002 2-Port FXS GSM Gateway

### • VoIP Call Controls

- Hot line connection function with PLAR (Private Line Auto Ring Down)
- Leased line emulation function
- Connection monitoring function
- Fault tolerant with Redundancy and Call Distribution among Gateways for load balancing
- Call attempt with IP address
- H.323, SIP, MGCP inbound call connection for each voice port
- Multiple E.164 setting for one voice port
- One E.164 or digit pattern can be assigned to more than one voice port
- Hunting with Longest match/ priority/ sequence/ random
- One stage call setup by Digit forwarding
- Call barring with specific digit patterns
- Calling and called number conversion for PSTN outbound calls
- PSTN rerouting in case of VoIP call attempt failure

### • VoIP Call Controls (cont.)

- Call transfer for internal calls
- Call pickup for internal calls
- Calling and called number conversion for VoIP outbound calls
- Calling and called number conversion for VoIP inbound calls
- Fax broadcasting call control

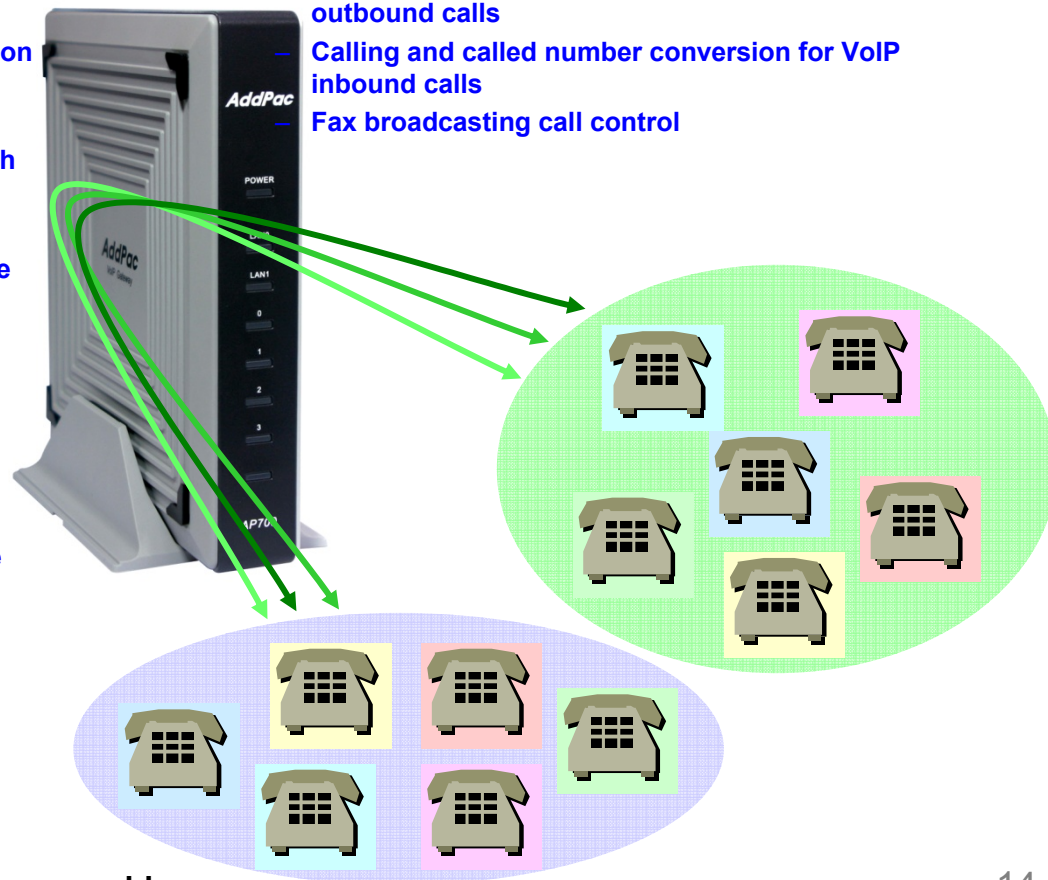

# Advanced QoS Features

## AP-GS1002 2-Port FXS GSM Gateway

- Enhances **Transmit** Voice QoS Features
  - Voice Traffic Priority Queuing
  - QoS Service Profiling
  - Providing Virtual Network Transmit Algorithm
  - Real-time Voice Traffic QoS Support
  - RTP Packet Transmit Interval Control
  - Supporting RTP Packet Redundancy Scheme
  - IP Header Control such as ToS, Diffserv
- Enhances **Receive** Voice QoS Features
  - Dynamic Jitter Buffer Management
  - Error Concealment
  - Support T.38 FAX Data Error Recovery Scheme

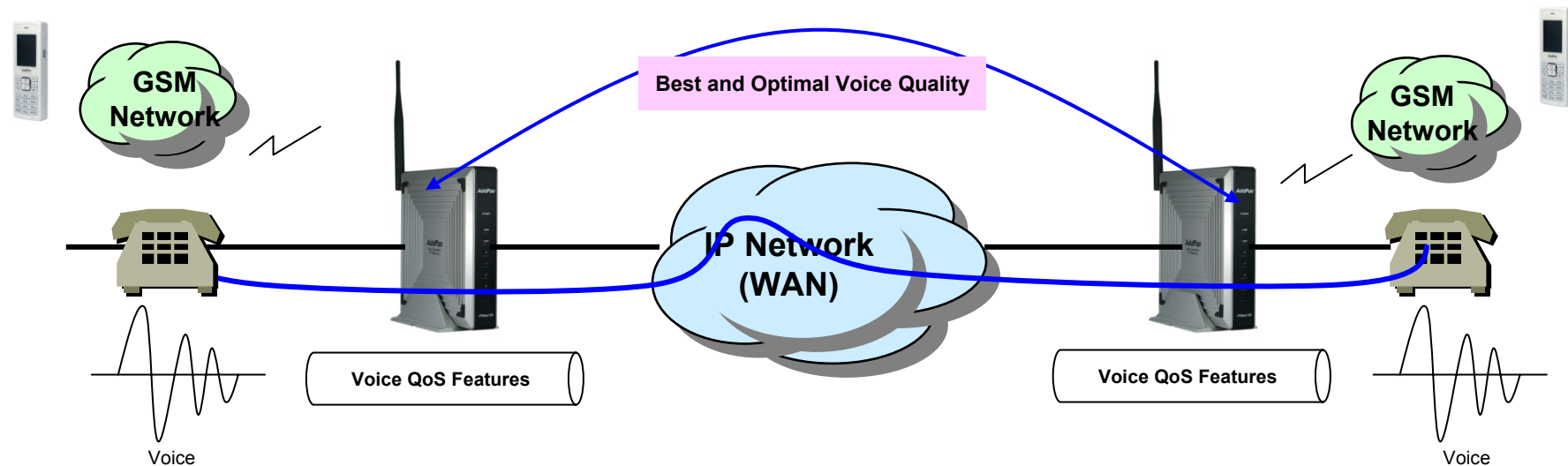

# Network Protocols

AP-GS1002 2-Port FXS GSM Gateway

## Basic Network Protocols

- ARP, IPv4, TCP, UDP, ICMP, SCTP, IGMP, MLD

## Routing Protocol

- IPv4 : Static

## Service Protocol

- FTP, Telnet, TFTP, DHCP Server/Relay, SNMP Server
- CDP (Cisco Discovery Protocol)
- DNS Resolver , DDNS(nsupdate)
- Bridge
- Syslog

## IPv4 Address Configuration

- Fixed (Static)
- DHCP
- PPPoE

## Miscellaneous

- Cisco Style CLI
- Standard & Extended IPv4 Access List
- Multi-level User Account Management
- IP accounting
- STUN Client

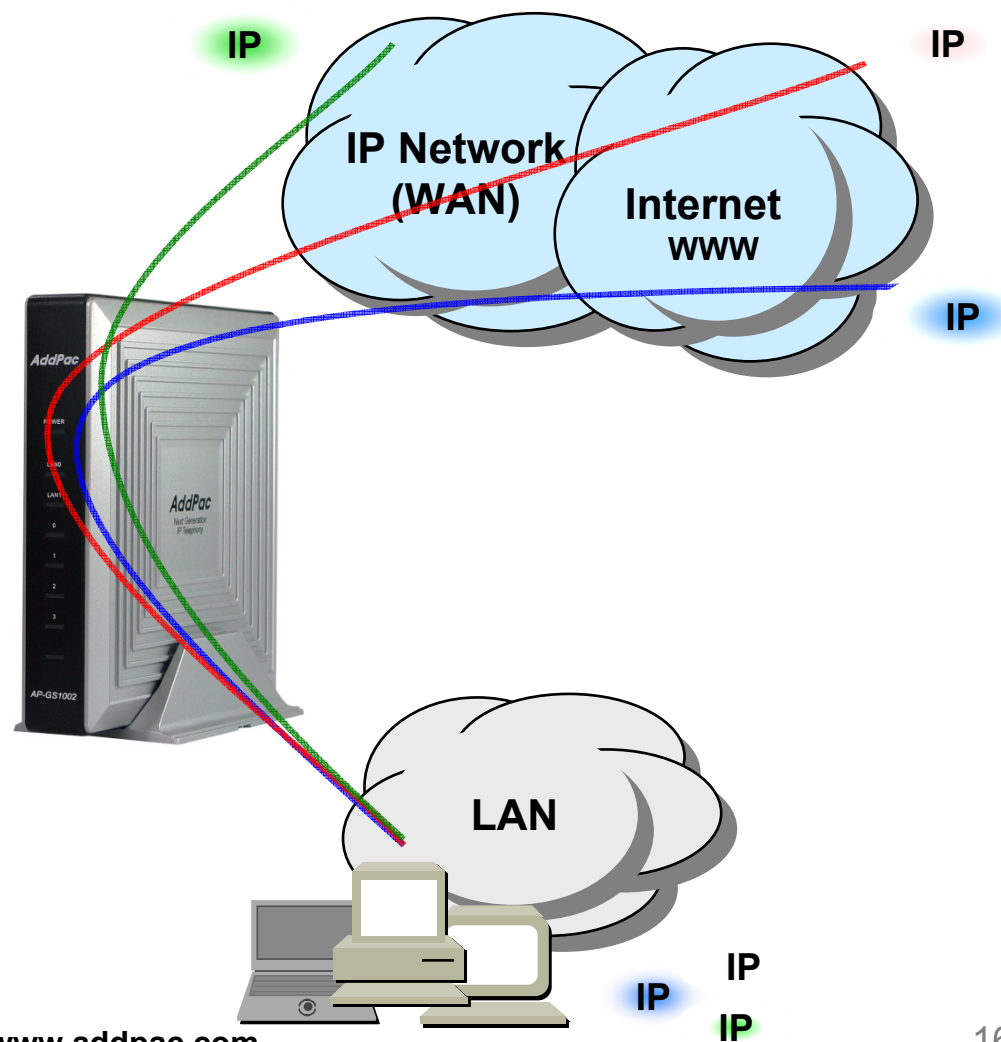



# Network Management

## AP-GS1002 2-Port FXS GSM Gateway

- **SNMP**

- Standard Simple Network Management Protocol( SNMP) Agent support
- MIB v1 and v2 Support

- **Web-based Management**

- Smart Easy Setup
- Standard Voice Interface
- Standard PSTN Back-up Interface

- **Watch-dog Function**

- Hardware, Software watch-dog services

- **Remote Management**

- Telnet
- Rlogin

- **Auto Upgrade Service**

- HTTP server based APOS image and configuration file auto-upgrade support

- **Batch Job Function**

- Text based script downloading

- **Interoperable with AP-VPMS Service**

- AddPac VoIP Plug & Play Management System (AP-VPMS)

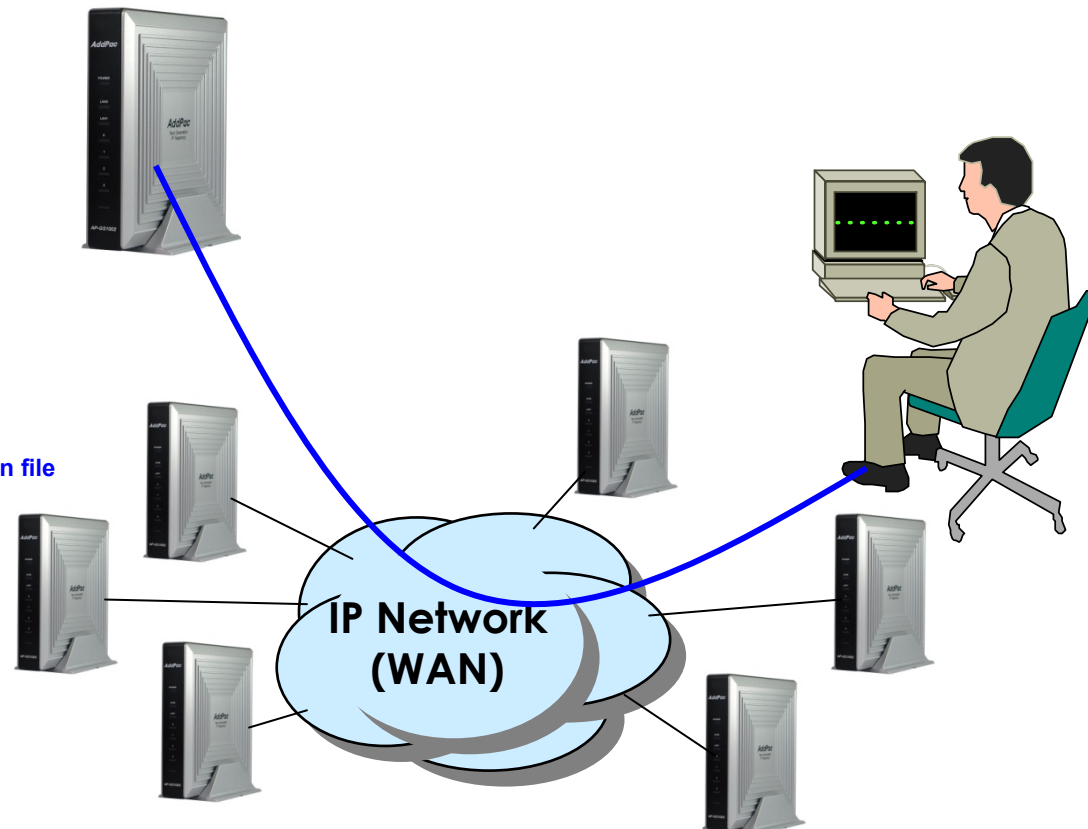

# Smart Web Manager : Main Page Layout

## AP-GS1002 2-Port FXS GSM Gateway

**Main Menu**  
For easy system setup, provide the various menu and category

- System
  - Network Setup
  - Language
  - NTP
  - Backup/Restore
- Basic
  - Protocol
  - Server SIP
  - Server H.323
  - Tel Number
  - FXS/FXO/E1 Group
  - E1 Trunk
  - DTMF/CODEC
  - Dial Plan/Prefix
  - Static Route
  - Hot Line
- Advanced
  - Gain
  - Fax
  - Service
  - Filtering
  - Security
  - SNMP
- Miscellaneous
  - Call Status
  - System Status
  - Alarm Status
  - Call Log
  - System Log
  - Test Call
  - Ping

**Tool Bar**  
Provide frequently used tools like as System Update, Configuration Backup, Initialization, Restart, Telnet

**System Information**

HW Version	2.0
SW Version	ap1800k_web_g2_v8_47T.bin 8.47
MAC Address	0002.a511.2245
VoIP Protocol	SIP
Voice Interface Module	S(4)O(4) : E1(2)
Registration Status	Unregistered
Supported Codec List	g711alaw g711ulaw g7231r53 g7231r63 g726r32 g729
Network Information	Static 172.16.50.114
WAN LINK Status	100Mbps FULL Duplex Link UP
LAN LINK Status	Link Down
Current Time	Thu Oct 1 13:06:23 2009
System Startup Time	Thu Oct 1 12:56:46 2009
System Running Time	0 days 00:09:37
Total Calls	0

**Information**  
Display the current system version and status summery

Information

AddPac Tehonology  
Model : AP1800K\_G2  
H/W Version : 2.0  
S/W Version : 8.47  
Smart Web Version : 0.3  
Smart Web Build : Oct 1 2009  
Voice Interface  
S(4)O(4) : E1(2)  
Protocol : SIP  
Status : Unregistered  
CurrentCalls : 0 Call  
Network : Static 172.16.50.114  
Mac Address: 0002.a511.2245

**Description**  
WAN 포트에 대한 설정입니다. Static IP의 경우 고정 IP 주소로 사업자로부터 할당 받은 주소 정보를 입력합니다. DHCP와 PPPoE의 경우 유동 IP로 장비의 주소가 변경될 수 있습니다. DHCP 및 PPPoE는 사용자 환경에 맞도록 설정하십시오. MAC 주소 변경은 필요시 장비에 설정된 주소를 사용하지 않고 사용자가 설정한 주소를 사용하는 방안으로 반드시 필요한 경우에 한하여 사용해야 합니다.

**Workspace**  
Workspace for detailed action

**Description**  
Display the help message if you move mouse over main menu

©AddPac Tehonology 2008-2009. all rights reserved.

# Smart Web Manager : E1 Trunk Configuration (Example)

## AP-GS1002 2-Port FXS GSM Gateway

**E1 Port**  
E1 Port Configuration  
Example : Slot is selected by tap button. Group in each E1 port can be added or deleted.

**E1 Port Configuration**  
Provide the detailed configuration menu about selected E1 port

**Tool Tip**  
Display the help message according to mouse move

**Smart Web Manager**  
www.addpac.com

**System**

- Network Setup
- Language
- NTP
- Backup/Restore

**Basic**

- Protocol
- Server SIP
- Server H.323
- Tel Number
- FXS/FXO/E1 Group
- E1 Trunk**
- DTMF/CODEC
- Dial Plan/Prefix
- Static Route
- Hot Line

**Advanced**

- Gain
- Fax
- Service
- Filtering
- Security
- SNMP

**Miscellaneous**

- Call Status
- System Status
- Alarm Status
- Call Log
- System Log
- Test Call
- Ping

**E1 Trunk**

Slot 1/0 Slot 1/1

Slot/Port	group Num (0)	Time slot Range(1-31,16-31,1,2,3)	Control
1/0	0	1-31	Delete
1/0	<input type="text" value="0"/>	<input type="text"/>	Add

**E1 Port (Slot 1/0)**

Clock-Source: Slave

Signaling-type: ISDN-PRI

ISDN-PRI

- Protocol-emulate:  Network  User
- Virtual-Connect:  Enable  Disable
- Immediate-disc:  Enable  Disable
- Dial-Tone-Generate:  Enable  Disable
- Comband-Type:  a-law  u-law
- N303:  (1-10sec)
- Q931 Timer: T303  (1-400sec)
- T310:  (5-400sec)
- R2-MFC: Get-Calling-number:  Enable  Disable

Busycout: Action

Apply

**Information**

AddPac Tehonology  
Model : AP1800K\_G2  
H/W Version : 2.0  
S/W Version : 8.47  
Smart Web Version : 0.3  
Smart Web Build : Oct 1 2009  
Voice Interface  
S(4)O(4) : E1(2)  
Protocol : SIP  
Status : Unregistered  
CurrentCalls : 0 Call  
Network : Static 172.16.50.114  
Mac Address : 0002.a511.2245

**Description**

E1 포트별 동작 방법을 설정합니다.

**Get-Calling-number**

enable로 체크해 주어야 할 내용으로 사설 교환기로 부터 발신번호 요청을 합니다. R2 방식일 경우에는 발신자 번호를 대국측에서 요청을 하여야만 받을 수 있습니다. 기본적으로 R2 pdd 값을 줄이기 위해서 초기 값은 0으로 설정되어 있습니다.

©AddPac Tehonology 2008-2009. all rights reserved.



# Security Management

## AP-GS1002 2-Port FXS GSM Gateway

- IP packet filtering
- IP access list
- User authentication function
  - Password Authentication Protocol (PAP)
  - Challenge Handshake Authentication Protocol (CHAP)
- Enable/Disable specific protocols
- Auto-square connect of Telnet session
- Account Management function for multi-level user
- SNMP/TELNET/FTP/HTTP/TFTP port assignment function
- SNMP/TELNET/FTP access list management
- Boot mode security checking function

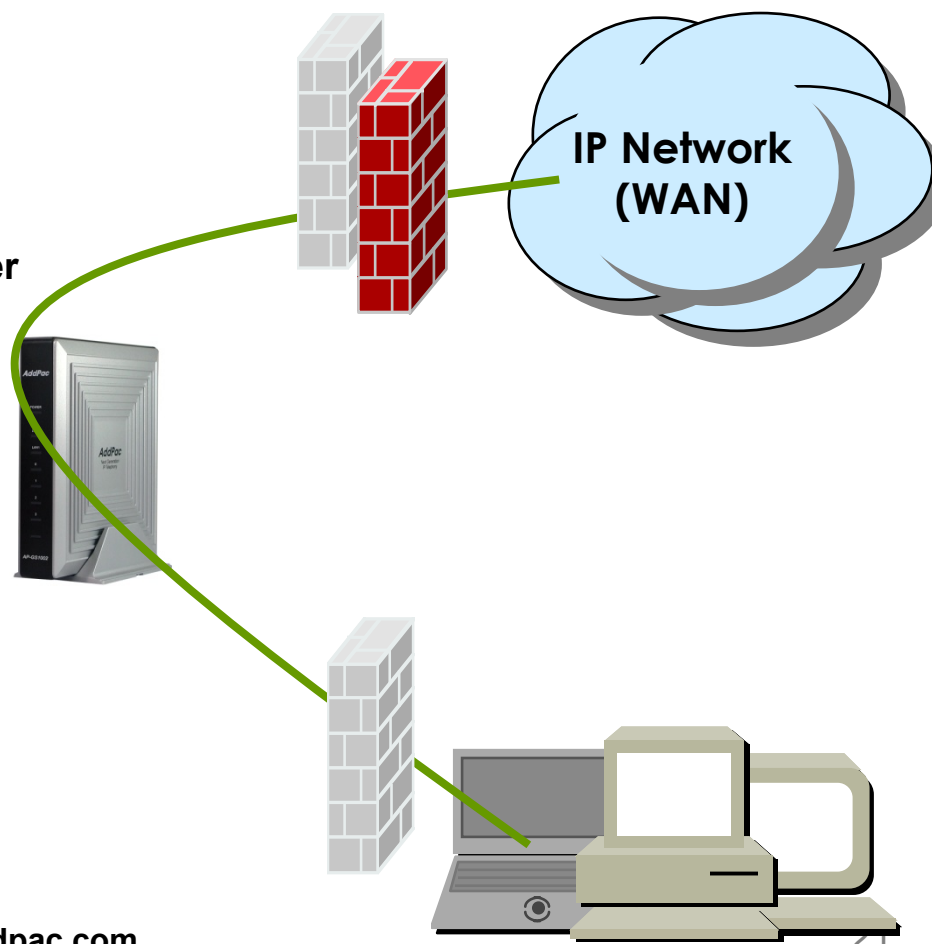

# Standard Application

## AP-GS1002 2-Port FXS GSM Gateway

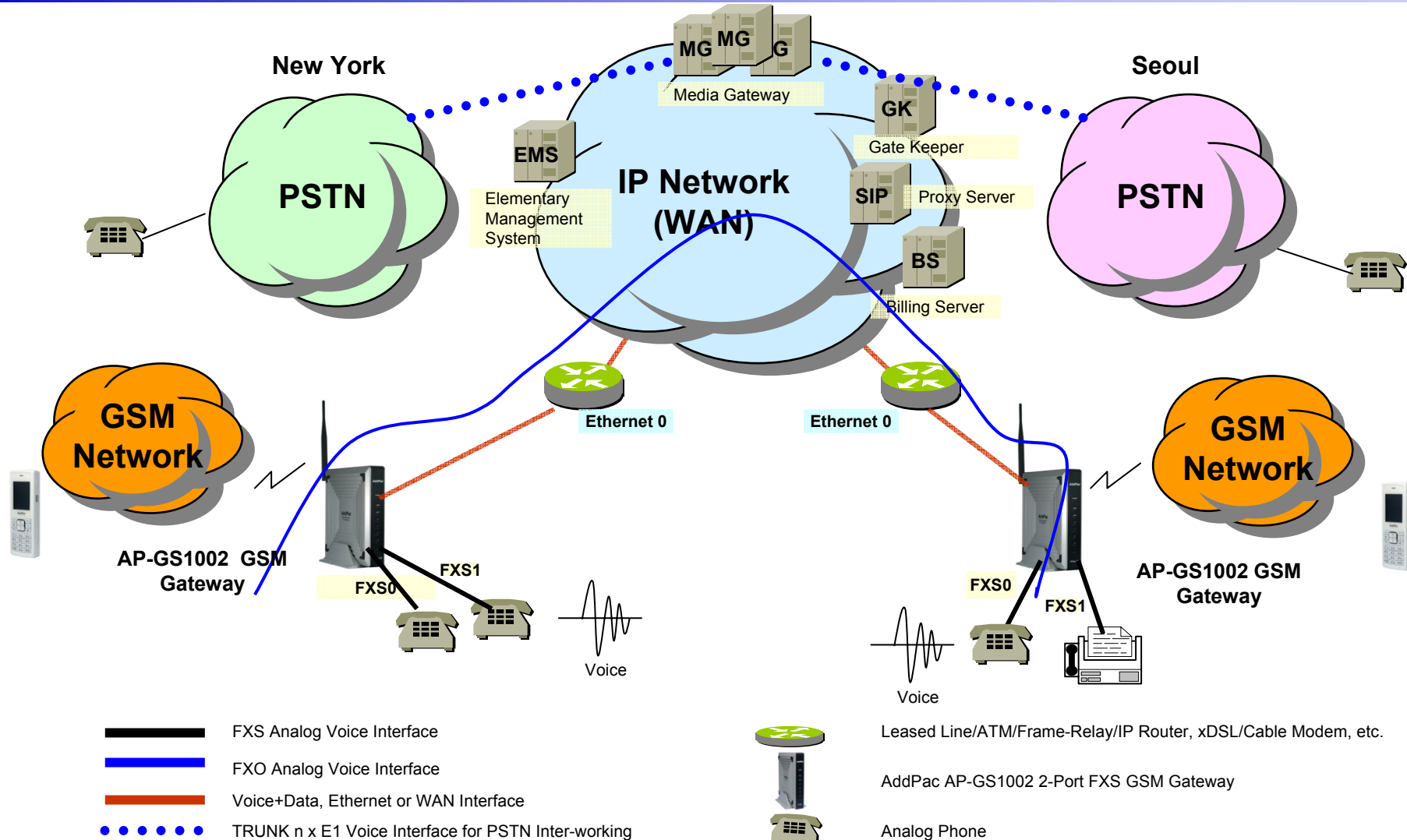

# Ordering Information

- **AP-GS1002 GSM Gateway Hardware**
  - AP-GS1002 GSM Gateway Main Body
  - RISC Microprocessor with High-end Programmable DSP Architecture
  - 2-Port FXS Interface(2xRJ11)
  - 2-ports 10/100Mbps Fast Ethernet(RJ45)
  - 1-Port RS232C Console Interface(RJ45)
  - Including Network Cable, Antenna & Ext. Power Supply, etc.
- **Built-in APOS Internetworking Software for AP-GS1002**
- **Including 1 Year Hardware Warranty**
- **Product Documents**
  - Install and Operation Guide (PDF)
- **Pricing**
  - AddPac Technology Regional Sales Manager
  - Authorized Sales and Marketing Representatives
  - Please Contact [www.addpac.com](http://www.addpac.com)

# GSM Gateway Series

# Thank you!

**AddPac Technology Co., Ltd.**  
Sales and Marketing

Phone +82.2.568.3848 (KOREA)

FAX +82.2.568.3847 (KOREA)

E-mail [sales@addpac.com](mailto:sales@addpac.com)