



AP-LMR2000

LMR(Land-to-Mobile Radio) Gateway

High Performance LMR Gateway Solution

Interworking with Motorola
XiR M8620 Radio Station



AddPac

AddPac Technology

2015, Sales and Marketing

www.addpac.com

Contents

- Product Overview
- Hardware Specification
- LMR(Land-to-Mobile Radio) Service
- RoIP System Message Flow Diagram
- VoIP (Voice over IP) Service
- Advanced QoS Features
- Network Protocols
- Network Management
- Security Management
- Application Service
- Ordering Information

Product Overview

AP-LMR2000 LMR Gateway

- Radio over IP Service Support
- Radio Systems(Motorola, etc) are Extended to IP Network
- High Performance RISC & Programmable DSP Architecture
- Two(2) 10/100Mbps Fast Ethernet (IP Share ,etc)
- High Performance LAN-to-LAN Routing Capability
- Two(2) Module Slots for Radio Interface (E&M, etc)
- VoIP Codec : G.711/G.726/G.723/G.729, VAD, etc
- Powerful Network Protocols (PPPoE, DHCP, Static Routing, etc)
- IPv4/IPv6 Dual Stack Support
- SIP/H.323 Dual Concurrent Signaling Protocols
- Firmware Upgradeable Architecture
- Advanced Voice QoS Mechanism
- Powerful Web based Management
- RS232C Port Support for Command Line Interface

Product Highlights

AP-LMR2000 LMR Gateway

LMR(Land-to-Mobile Radio) Gateway Solution

State-of-art Signaling
H.323, SIP
Concurrent Dual Stack

High Performance
Radio over IP Service

Excellent Voice Quality
G.729/G.723/G726/G711

High Performance RISC CPU
+ Programmable DSP

Two(2) Module
Slot for Radio Interface,
Internal Power Supply

Broadband IP Networking
With dual 10/100Mbps
Fast Ethernet

APOS™ Technology
Firmware Upgradeable Architecture

High Performance
LAN-to-LAN Packet Routing
Processing

Powerful Network Protocol
Support

Powerful Trouble Shooting &
Debugging Feature Support

Advanced Voice
Traffic QoS Mechanism

AddPac

www.addpac.com

Hardware Specification

AP-LMR2000 LMR Gateway

RISC
CPU

High-end
DSP

- RISC Microprocessor Computing Power
- Main Chassis
 - Network Interface
 - Two(2) 10/100Mbps Fast Ethernet
 - One(1) RS-232C Console (RJ45)
 - Two(2) Radio Module Slots for E&M, etc
 - Internal Power Supply

Hardware Specification

AP-LMR2000 LMR Gateway

AP-LMR2000 Back Side

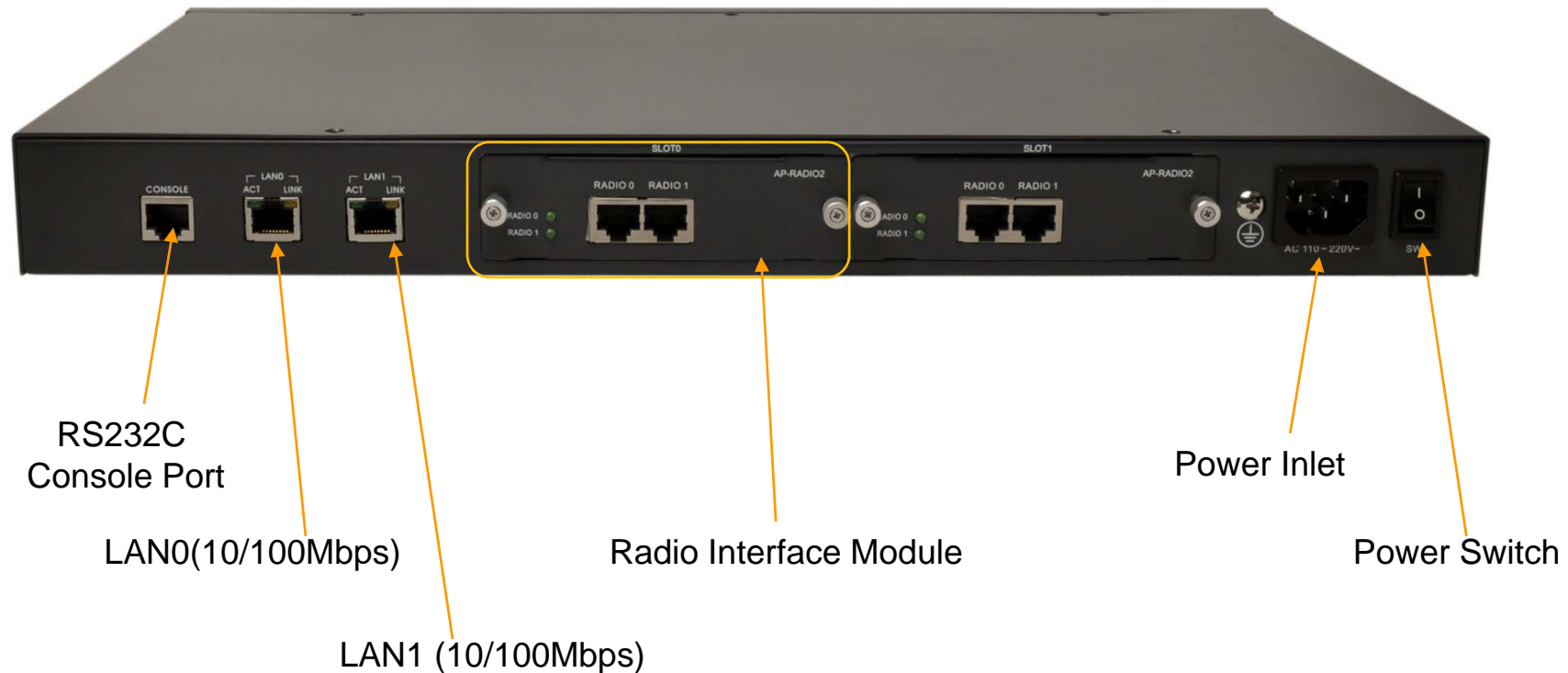

Hardware Specification

AP-LMR2000 LMR Gateway

Example : AP-RADIO2 Radio Interface Module for Motorola XiR M8620



LMR Service

AP-LMR2000 LMR Gateway

- LMR system overview
 - A LMR(Land Mobile Radio) system is a collection of portable and stationary radio units designed to communicate with each other.
 - LMR is deployed wherever organizations need to have instant communication between geographically dispersed and mobile personnel.
 - Typical LMR system users are public safety organizations (ex: police departments, fire departments, etc).
 - The systems are extended the range of communications by repeaters.
 - The systems are required interoperability with IP network.

LMR Service

AP-LMR2000 LMR Gateway

- **AddPac RoIP Solution Features**
 - LMR Gateway(AP-LMR2000) joins the LMR systems to the IP network through open SIP standard and RTP.
 - The radios are connected to LMR gateway through AddPac radio interface (reference LMR signal).
 - AddPac IP PTT terminals (AP-IP230, AP-IP300 IP Phones, AP-WP100 WiFi-Phone, etc) support the traditional radio user interface(PTT).
 - AddPac IP PTT terminals easy PTT group management user interface.
 - IP-PBX support call management, PTT group management, PTT control and various additional service.
 - PTT Server(AP-PTS3000) support powerful media data relay, broadcasting, multicasting and PTT group management.
 - RoIP Solution supports emergency and group PTT service.

LMR Service Examples

AP-LMR2000 LMR Gateway

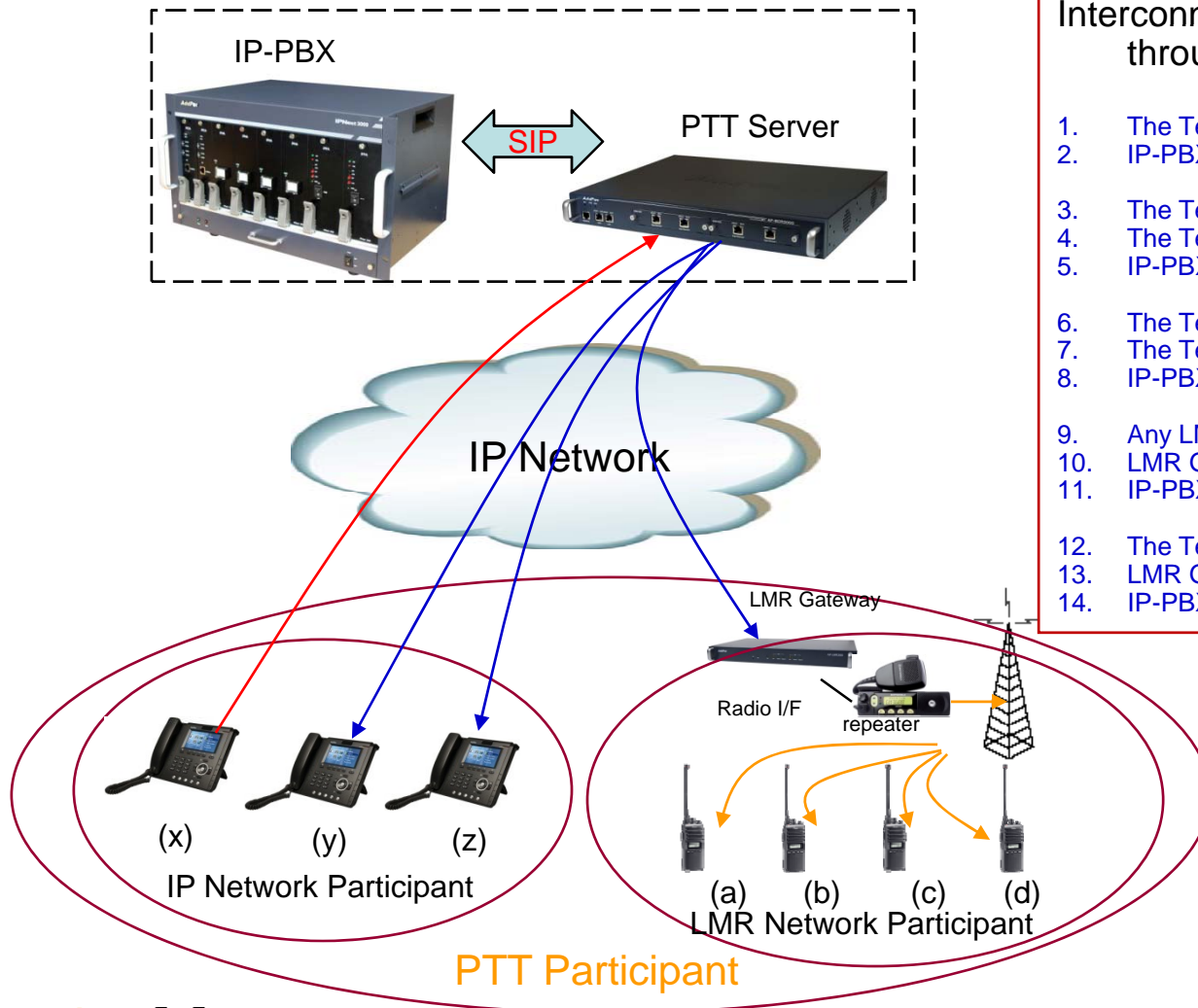

Interconnection LMR systems to IP network through AddPac RoIP solution.

1. The Terminal(x) originate a PTT conference.
2. IP-PBX send invitation message to all participant.
3. The Terminal(x) presses the 'floor button' to talk.
4. The Terminal(x) send a 'floor-request' message.
5. IP-PBX and PTT servers control media-relay.
6. The Terminal(x) releases the 'floor button'.
7. The Terminal(x) send a 'release-request' message.
8. IP-PBX and PTT servers control media-relay.
9. Any LMR Terminal(a~d) presses the 'floor button' to talk.
10. LMR Gateway send a 'floor-request' message.
11. IP-PBX and PTT servers control media-relay.
12. The Terminal(a) releases the 'floor button'.
13. LMR Gateway send a 'release-request' message.
14. IP-PBX and PTT servers control media-relay.

| | |
|---------------------------------------|---------------------|
| — | RTP (floor) |
| — | RTP (Participant) |
| — | Radio (Participant) |

RoIP System Message Flow (Example)

AP-LMR2000 LMR Gateway

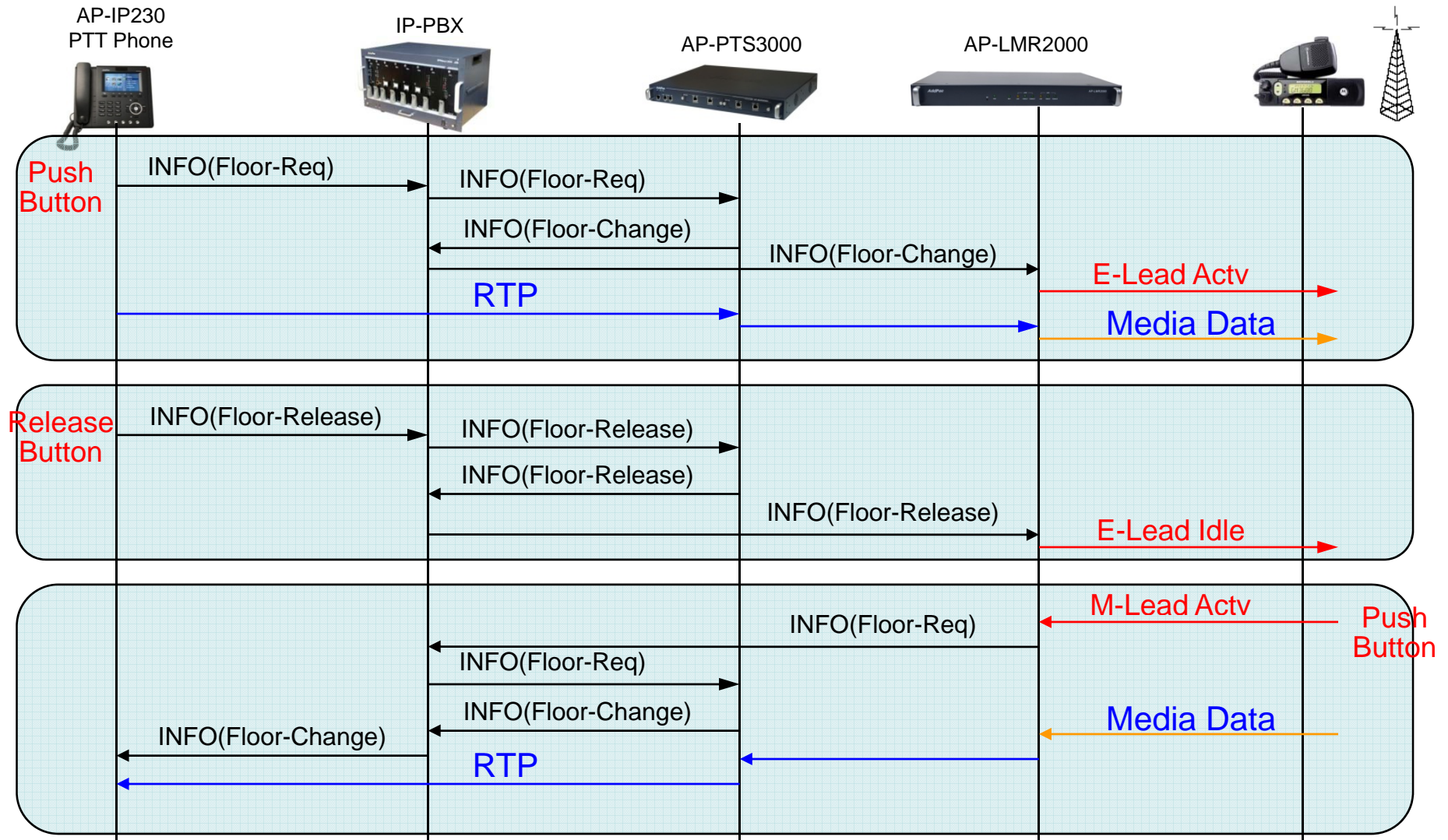

VoIP (Voice over IP) Service

AP-LMR2000 LMR Gateway

- **H.323, SIP Dual Stack**
- **H.323**
 - ITU-T Standard H.323 v3 Support
 - Support H.245 Tunneling
 - Including H.235 Security Features
- **SIP**
 - IETF RFC3261 or RFC2543 SIP Standard

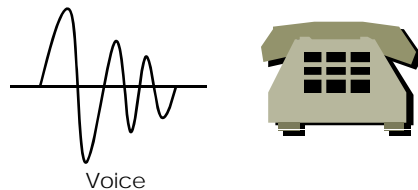
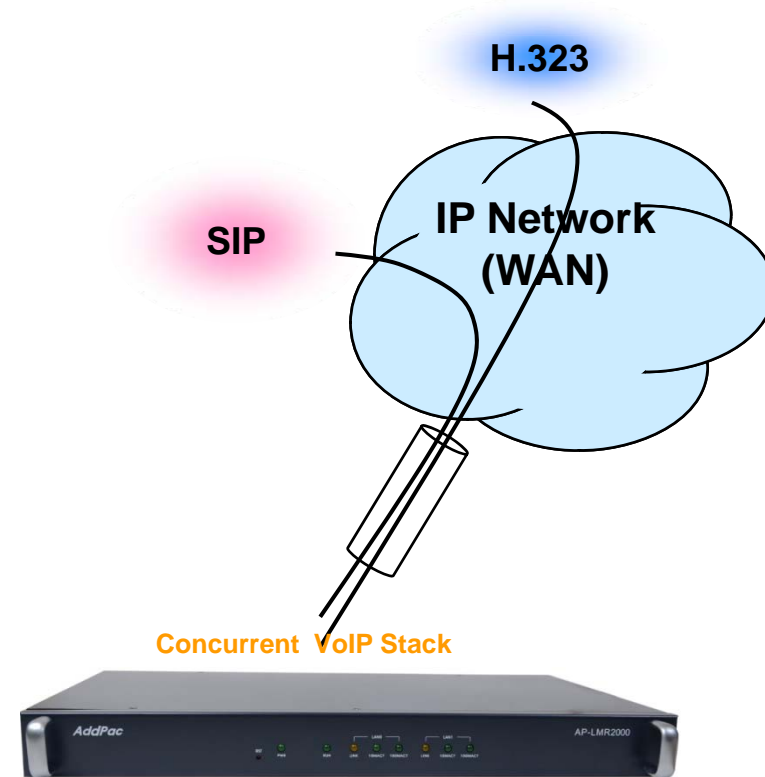

VoIP (Voice over IP) Service

AP-LMR2000 LMR Gateway

- **H.323**

- Fast connect, normal connect support
- H.245 tunneling support
- Q.931 response message setting for inbound VoIP calls
- H.245 logical channel open timing selection function
- Start H.245 procedure support
- DTMF / Hook flash relay with H.245 alphanumeric / signal
- Secondary gatekeeper support
- Gatekeeper assignment according to the domain name
- Gatekeeper discovery with multicast
- Lightweight RRQ support
- Signaling TCP port assignment
- Resource threshold setting with RAI
- H.235 clear-token, crypto-token support
- canMapAlias support
- Technical prefix (supported prefix) support
- Public IP assignment in NAT environment

- **SIP**

- Gateway-based / Endpoint-based registration support
- Secondary proxy-server assignment function
- SIP signaling port change function
- SIP proxy server assignment according to the domain name
- T.38 real-time fax relay support
- DTMF relay support with RFC2833 / OPTION message
- Re-INVITE support

VoIP (Voice over IP) Service

AP-LMR2000 LMR Gateway

- **Voice Codec**

- G.711 A-Law, G.711 U-Law
- G.726 r16, G.726 r32
- G.729A
- G.723.1 r63, G.723.1 r53
- VAD (Voice Activity Detection) function support
- DTMF relay support (H.323, SIP, MGCP common) based on RFC2833

- **RTP**

- Redundant RTP packet transmission in case of severe packet loss
- Dynamic jitter buffer management and RPT packet jitter and loss compensation with heuristic & DSP error concealment
- Static jitter buffer setting support
- Voice frame per RTP packet number control for each codec
- In-band ring-back tone support
- Virtual ring-back tone support
- Tone parameter change support

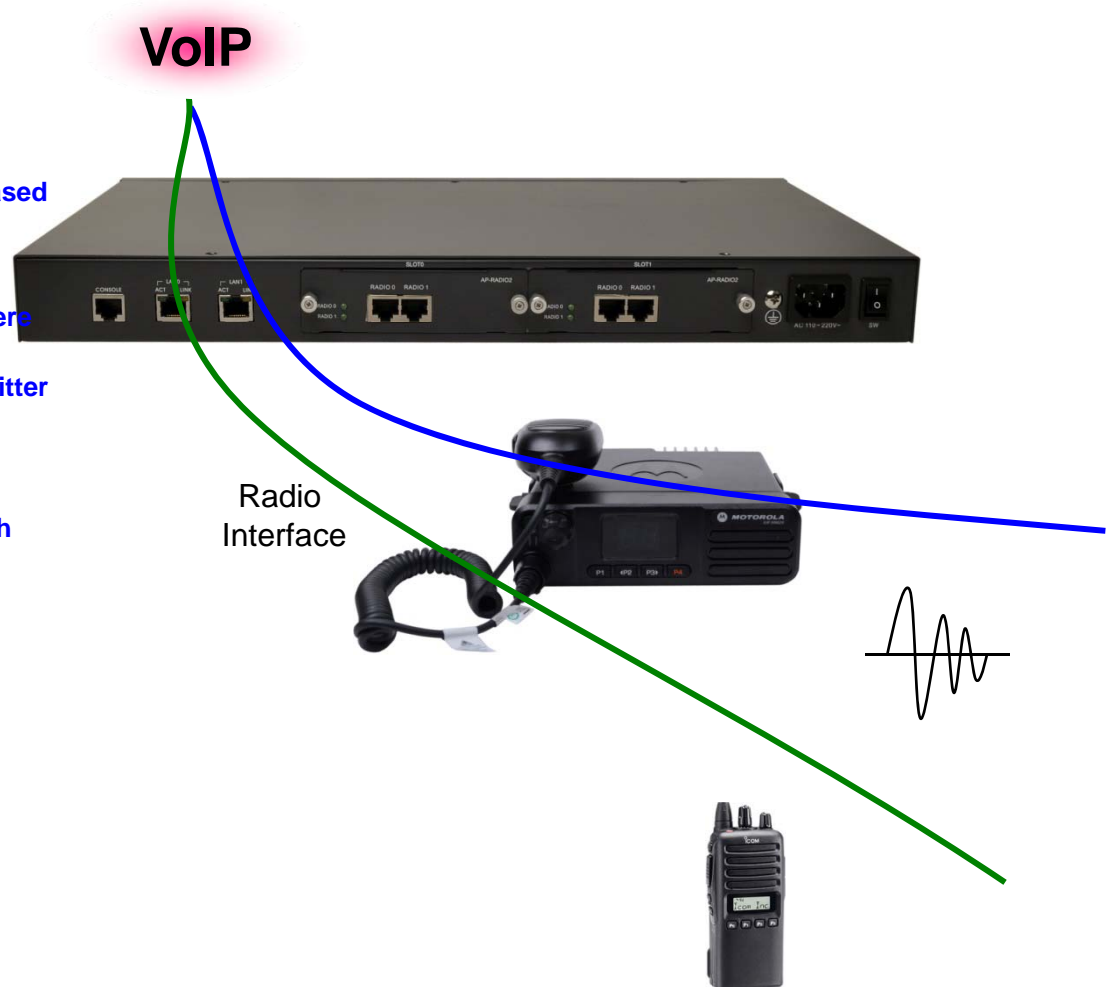

VoIP (Voice over IP) Service

AP-LMR2000 LMR Gateway

• VoIP Call Controls

- Hot line connection function with PLAR (Private Line Auto Ring Down)
- Leased line emulation function
- Connection monitoring function
- Fault tolerant with Redundancy and Call Distribution among Gateways for load balancing
- Call attempt with IP address
- H.323, SIP, MGCP inbound call connection for each voice port
- Multiple E.164 setting for one voice port
- One E.164 or digit pattern can be assigned to more than one voice port
- Hunting with Longest match/ priority/ sequence/ random
- One stage call setup by Digit forwarding
- Call barring with specific digit patterns
- Calling and called number conversion for PSTN outbound calls
- PSTN rerouting in case of VoIP call attempt failure

• VoIP Call Controls (cont.)

- Call transfer for internal calls
- Call pickup for internal calls
- Calling and called number conversion for VoIP outbound calls
- Calling and called number conversion for VoIP inbound calls
- Fax broadcasting call control

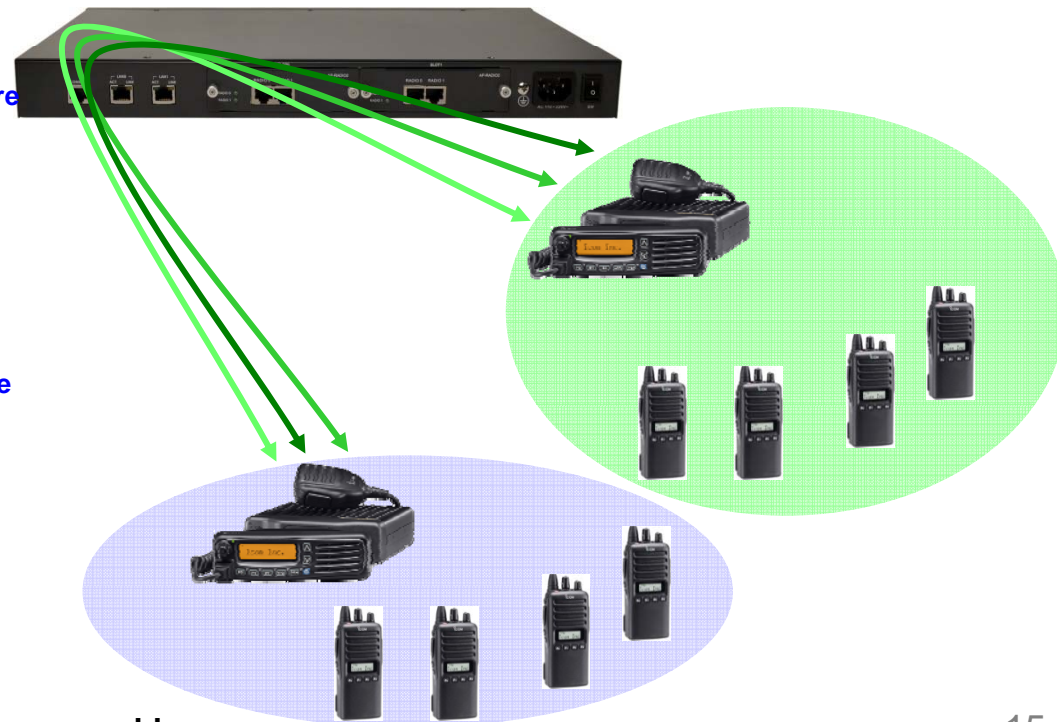

Advanced QoS Features

AP-LMR2000 LMR Gateway

- Enhances **Transmit** Voice QoS Features
 - Voice Traffic Priority Queuing
 - QoS Service Profiling
 - Providing Virtual Network Transmit Algorithm
 - Real-time Voice Traffic QoS Support
 - RTP Packet Transmit Interval Control
 - Supporting RTP Packet Redundancy Scheme
 - IP Header Control such as ToS, Diffserv
- Enhances **Receive** Voice QoS Features
 - Dynamic Jitter Buffer Management
 - Error Concealment
 - Support T.38 FAX Data Error Recovery Scheme

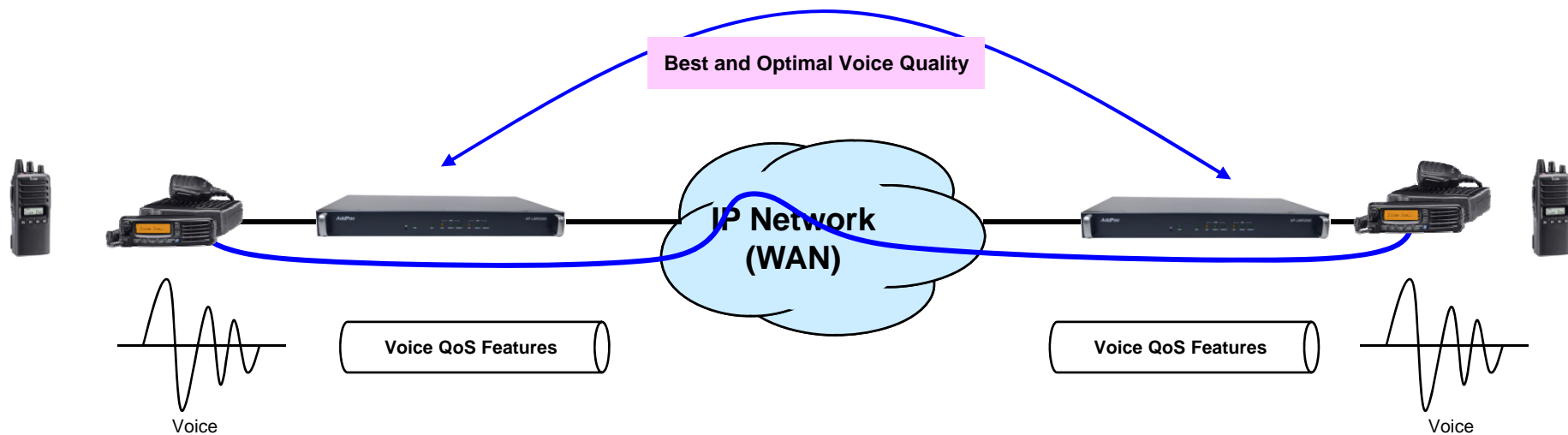

Network Protocols

AP-LMR2000 LMR Gateway

Basic Network Protocols

- ARP, IPv4, TCP, UDP, ICMP, SCTP, IGMP, MLD

Routing Protocol

- IPv4 : Static

Service Protocol

- FTP, Telnet, TFTP, DHCP Server/Relay, SNMP Server
- CDP (Cisco Discovery Protocol)
- DNS Resolver , DDNS(nsupdate)
- Bridge
- Syslog

IPv4 Address Configuration

- Fixed (Static)
- DHCP
- PPPoE

Miscellaneous

- Cisco Style CLI
- Standard & Extended IPv4 Access List
- Multi-level User Account Management
- IP accounting
- STUN Client

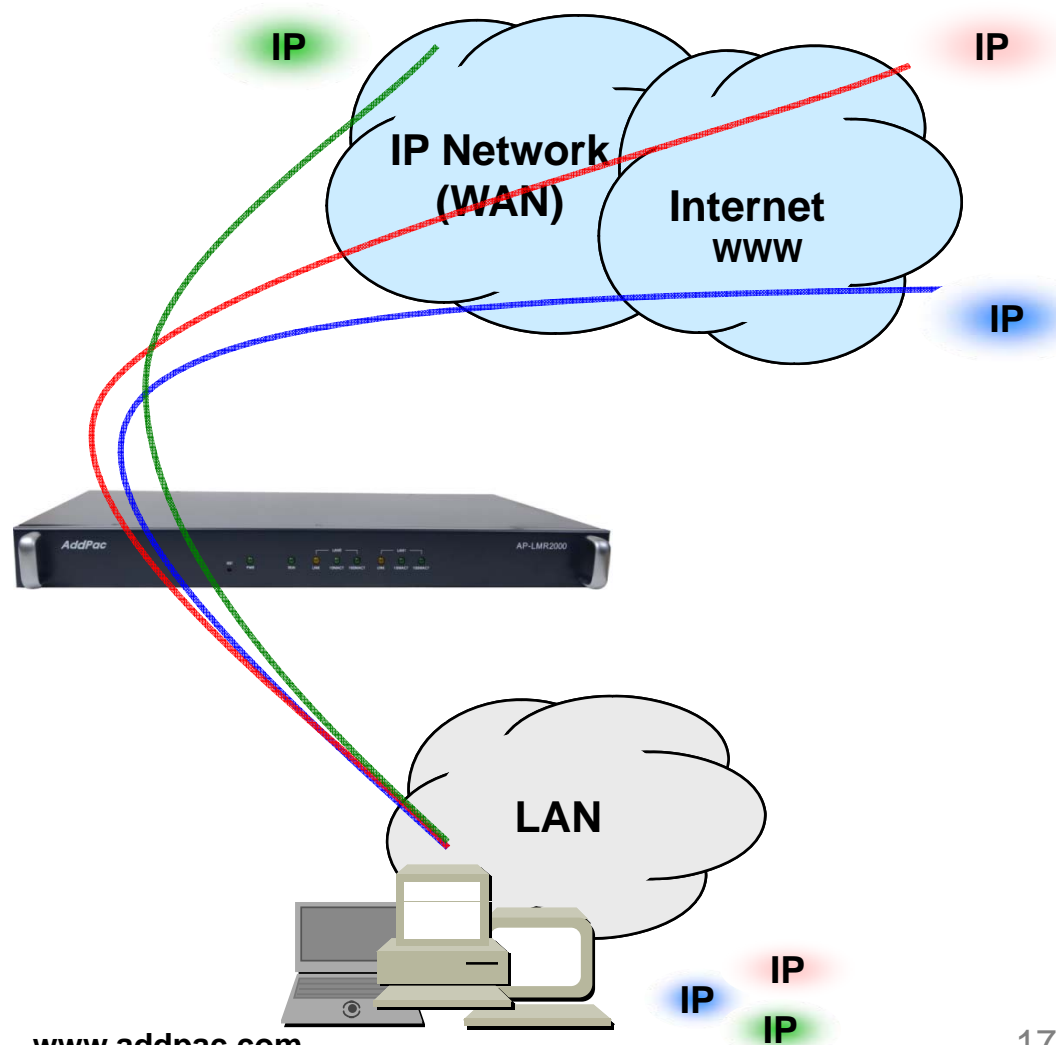

Network Management

AP-LMR2000 LMR Gateway

- **SNMP**

- Standard Simple Network Management Protocol(SNMP) Agent support
- MIB v1 and v2 Support

- **Web-based Management**

- Smart Easy Setup
- Standard Voice Interface
- Standard PSTN Back-up Interface

- **Watch-dog Function**

- Hardware, Software watch-dog services

- **Remote Management**

- Telnet
- Rlogin

- **Auto Upgrade Service**

- HTTP server based APOS image and configuration file auto-upgrade support

- **Batch Job Function**

- Text based script downloading

- **Interoperable with AP-SNMS Service**

- AddPac Smart Network Management System (AP-SNMS)

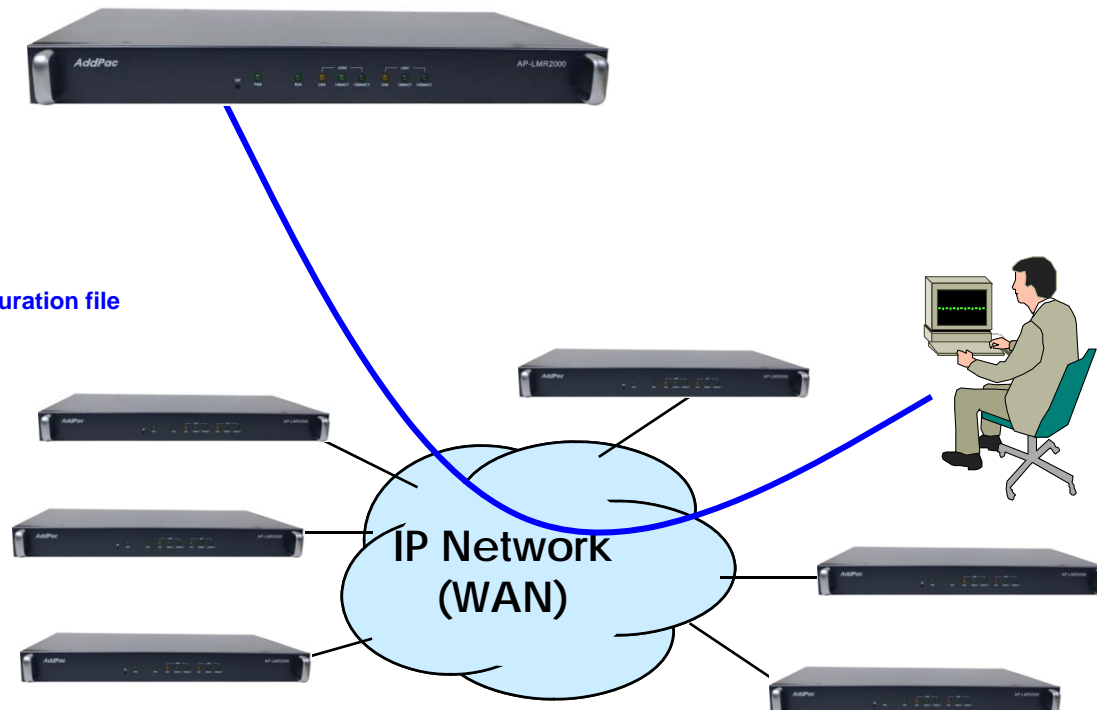

Security Management

AP-LMR2000 LMR Gateway

- IP packet filtering
- IP access list
- User authentication function
 - Password Authentication Protocol (PAP)
 - Challenge Handshake Authentication Protocol (CHAP)
- Enable/Disable specific protocols
- Auto-square connect of Telnet session
- Account Management function for multi-level user
- SNMP/TELNET/FTP/HTTP/TFTP port assignment function
- SNMP/TELNET/FTP access list management
- Boot mode security checking function

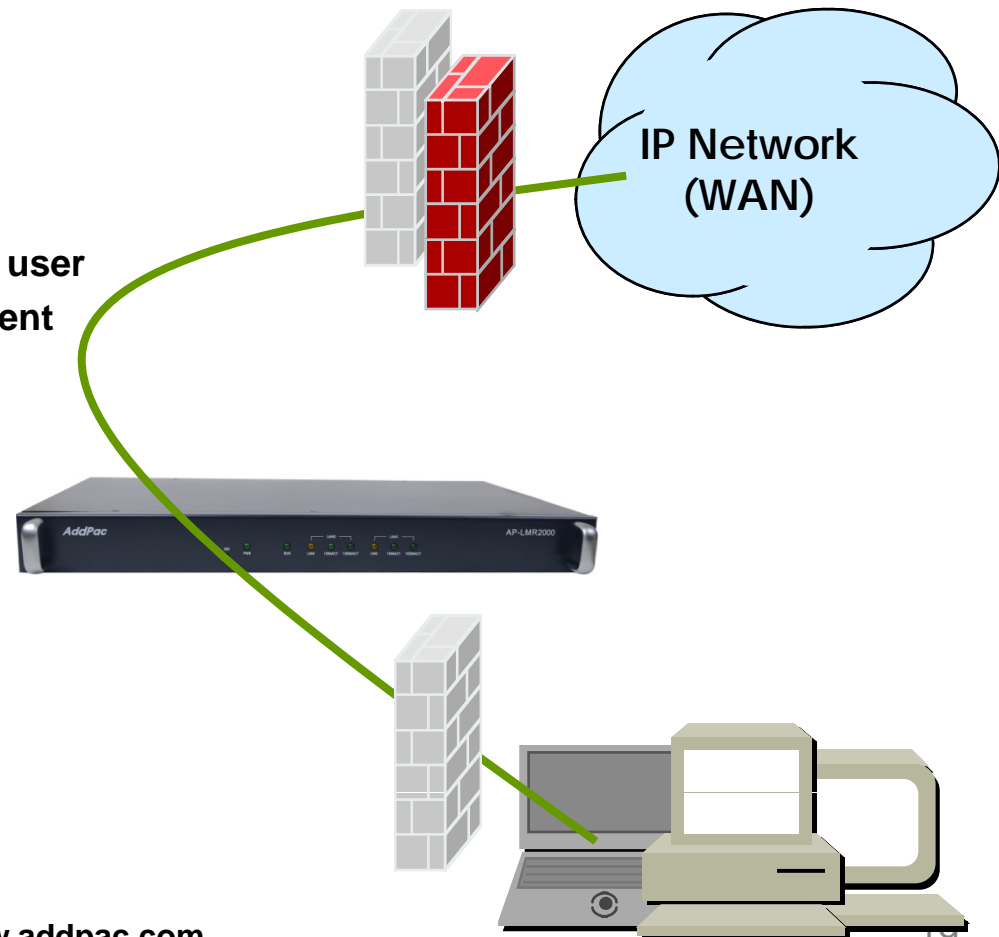

RoIP Network Diagram

AP-LMR2000 LMR Gateway

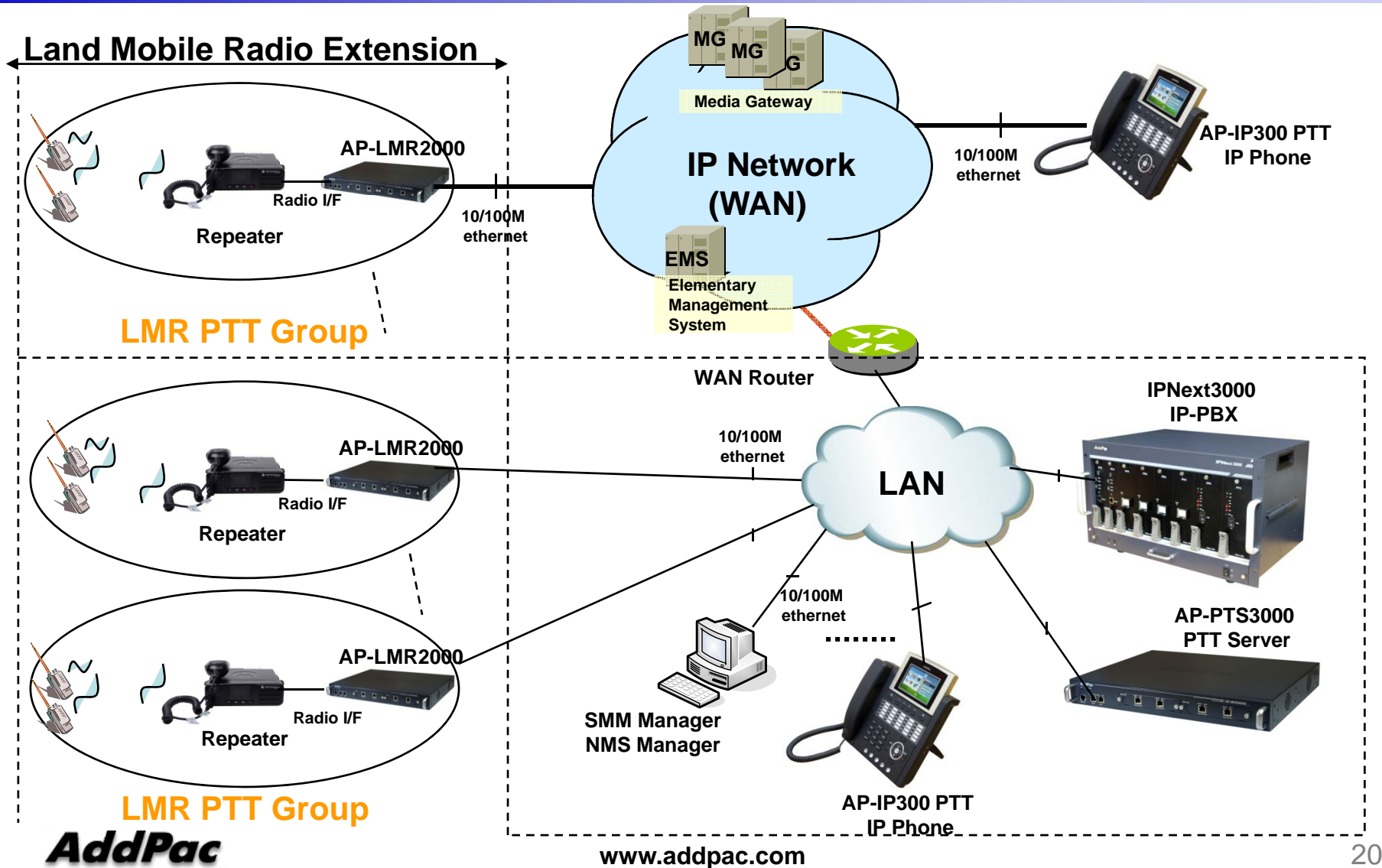



Interworking with Motorola *XiR M8620* Radio Station

AP-LMR2000 and Motorola XiR M8620

AP-LMR2000 LMR Gateway



Motorola XiR M8620 Radio Station



AP-RADIO2 Module for M8620

AP-LMR2000 and Motorola XiR M8620

PTT (Push-to-Talk) Signal Pin Diagram

AP-LMR2000 LMR Gateway
AP-RADIO2 Module for M8620 Radio Station

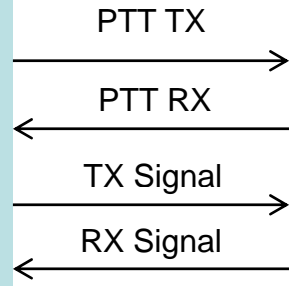
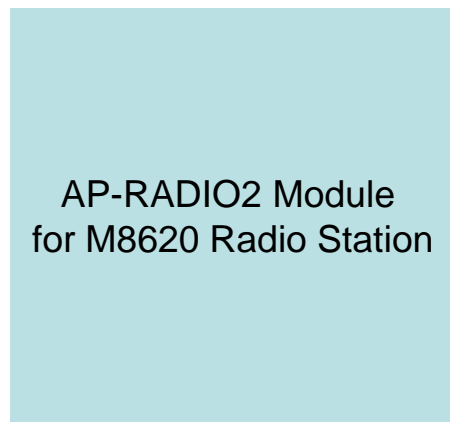

Ordering Information

- **AP-LMR2000 LMR Gateway Hardware**
 - AP-LMR2000 Main Body
 - RISC Microprocessor with High-end Programmable DSP Architecture
 - Two(2) Module Slots for Radio Interface
 - 2-ports 10/100Mbps Fast Ethernet(RJ45)
 - Option Module: AP-RADIO2, etc
 - Including Network Cable & Ext. Power Supply, etc.
- **Built-in APOS Internetworking Software for AP-LMR2000**
- **Including 1 Year Hardware Warranty**
- **Product Documents**
 - Install and Operation Guide (PDF)
- **Pricing**
 - AddPac Technology Regional Sales Manager
 - Authorized Sales and Marketing Representatives
 - Please Contact www.addpac.com



Thank you!

AddPac Technology Co., Ltd.
Sales and Marketing

Phone +82.2.568.3848 (KOREA)

FAX +82.2.568.3847 (KOREA)

E-mail sales@addpac.com