



# AP3120 IP based Broadcasting System



Technical Sales and Marketing

**AddPac Technology**

[www.addpac.com](http://www.addpac.com)

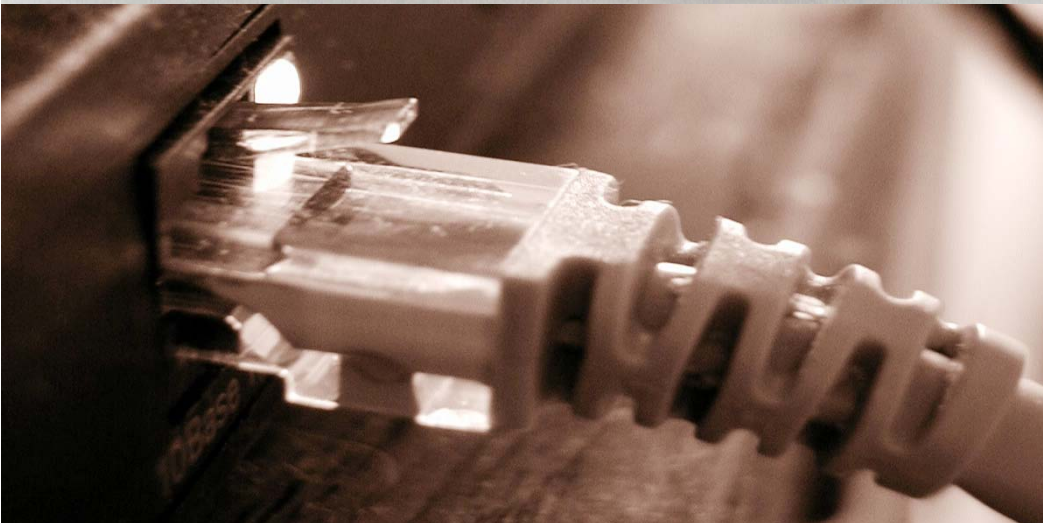

# Contents

- What is IP Audio Broadcasting ?
- AddPac IP Audio Broadcasting Solution
- APOS™ for AP3120 IP Audio Broadcasting Server
- AP3120 System Overview
- AP3120 System Configuration
- AP3120 Management Scheme
- Network Configuration & Case Study
- Appendix

# What is IP Audio Broadcasting ?

## IP Audio Broadcasting Service Scheme

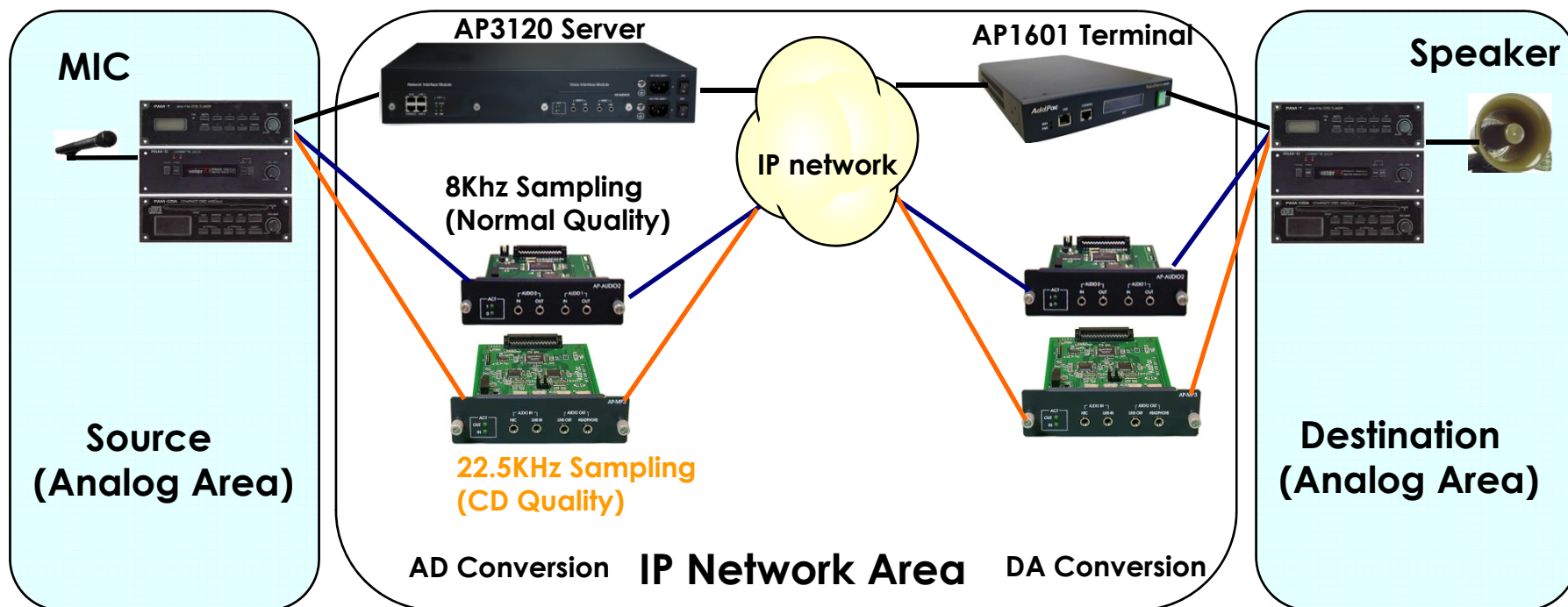

Item	Service Function	Support System
Source	Analog Audio → Audio stream	AP3120 (or Terminal Controlled by AP-BMS)
Relay	Copy Audio Stream to Multi-destinations	AP3120
Terminal	Audio Stream → Analog Audio	AP1601, AP2120, AP2520, AP2850 ...

# What is IP Audio Broadcasting ?

## IP Audio Broadcasting Message Flow

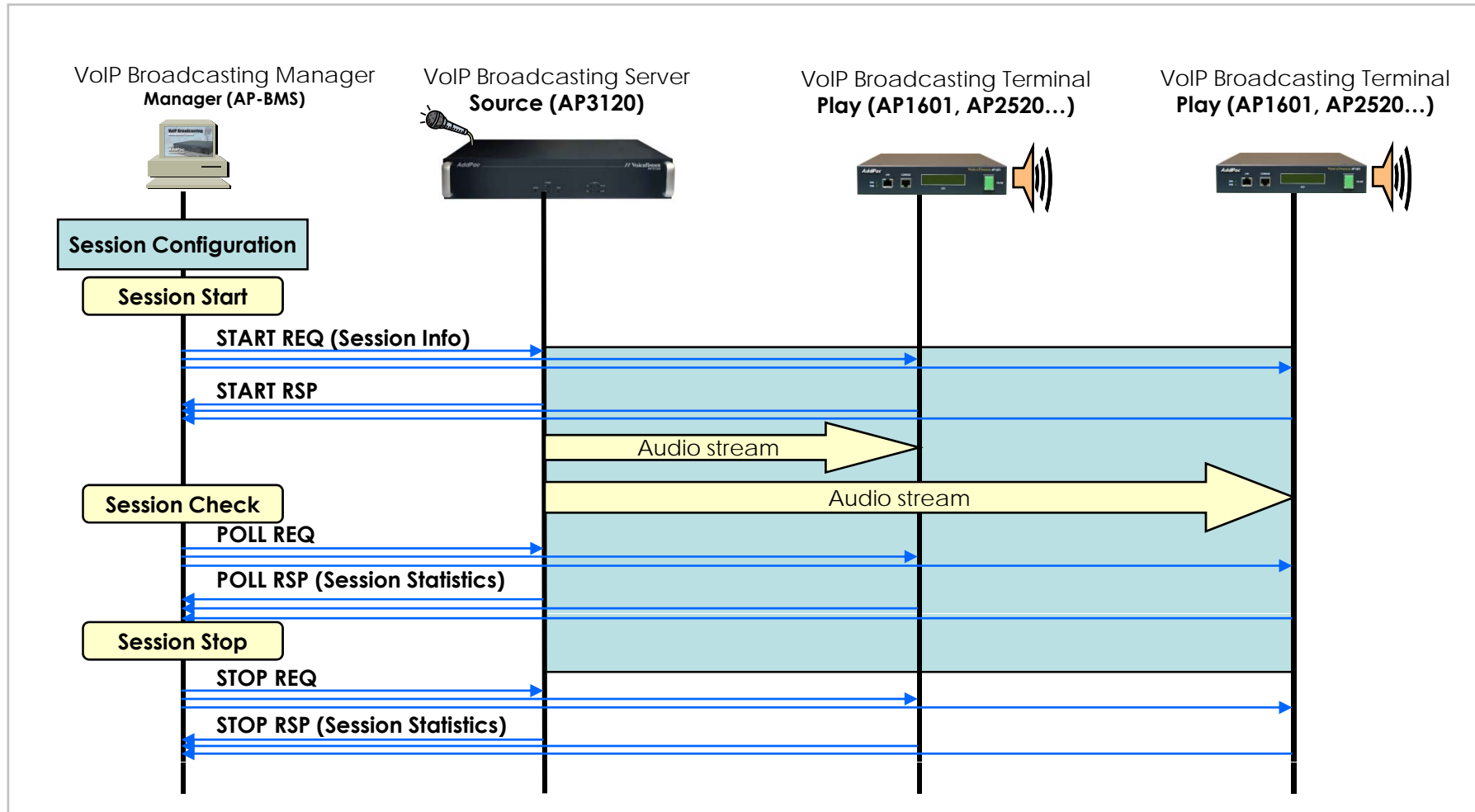

# What is IP Audio Broadcasting ?







## IP Audio Broadcasting Evolution

- **Beyond the existing Broadcasting System**
  - Realizing high quality broadcasting (From Voice level to audio level)
  - Utilizing reasonable IP network, replacing expensive voice-dedicated line
  - Eliminating Integration & Management difficulties
- **Extended Bandwidth & Contents**
  - Expanded Bandwidth and Various Contents
  - ADSL → VDSL → FTTH
  - Doubled bandwidth in one year
  - Internet arena asking for more than PC contents
- **To meet NGN arena based on IP network**
  - Intelligent communication system
  - Modularized, flexible architecture, adoptable to rapidly changing network environment
- **IP Broadcasting is the future of telephony service**
  - The Quality of telephony service will be upgraded in the future.
- **Multi Codec Support**
  - G.711 A-Law, G.711 U-Law / G.726 r16, G.726 r32 / G.729A / G.723.1 r63, G.723.1 r53



# AddPac IP Audio Broadcasting Solution

## IP Audio Broadcasting Components

	Model	Function	
Base Components	AP3120	<ul style="list-style-type: none"> <li>▪ <b>Server</b></li> <li>▪ Source broadcasting &amp; relay</li> <li>▪ Management</li> </ul>	
	AP1601, AP2xxx	<ul style="list-style-type: none"> <li>▪ <b>Terminal</b></li> <li>▪ Broadcasting receive &amp; play</li> </ul>	
	AP-BMS	<ul style="list-style-type: none"> <li>▪ <b>Manager</b></li> <li>▪ GUI based broadcasting manage.</li> </ul>	
Option Components	AP-AUDIO2	<ul style="list-style-type: none"> <li>▪ <b>Voice Band Audio</b></li> <li>▪ 2Pair audio in/out interface module</li> </ul>	
	AP-AUD1S3	<ul style="list-style-type: none"> <li>▪ <b>Voice Band Audio + VoIP Interface</b></li> <li>▪ 1Pair audio in/out+FXS3 voice ports</li> </ul>	
	AP-AUD1S2O1	<ul style="list-style-type: none"> <li>▪ <b>Voice Band Audio + VoIP Interface</b></li> <li>▪ 1audio in/out+FXS2+FXO1 voice ports</li> </ul>	
	AP-PSB	<ul style="list-style-type: none"> <li>▪ <b>Power Switching Box</b></li> <li>▪ Remote side AMP power manage.</li> </ul>	

# AddPac IP Audio Broadcasting Solution

## IP Audio Broadcasting Products

### All Embedded Broadcasting Solution

#### Server Side Solution

AP3120 IP Audio Broadcasting Server



#### Terminal Side Solution

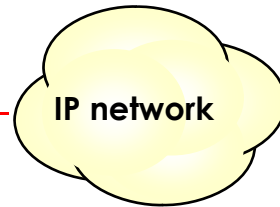

#### PC based Management Scheme



AP-BMS Broadcasting Manager Software

#### Optional Audio Module Solution



AP-AUDIO2 Module



AP-AUD1S3 Module



AP-AUD1S2O1 Module

#### Accessory for AMP. Power Control



AP-PSB Power Switching Box

# The Vision of Next Generation Audio Broadcasting

## APOS™ (AddPac Operating System) Introduction for AP3120 IP Audio Broadcasting Server

### AP3120



**AddPac**

[www.addpac.com](http://www.addpac.com)

8

Aug. 2003, IP based Broadcasting System Presentation R1.00



# APOS™ for IP Audio Broadcasting Server

## APOS™ Internetworking Protocol Stack

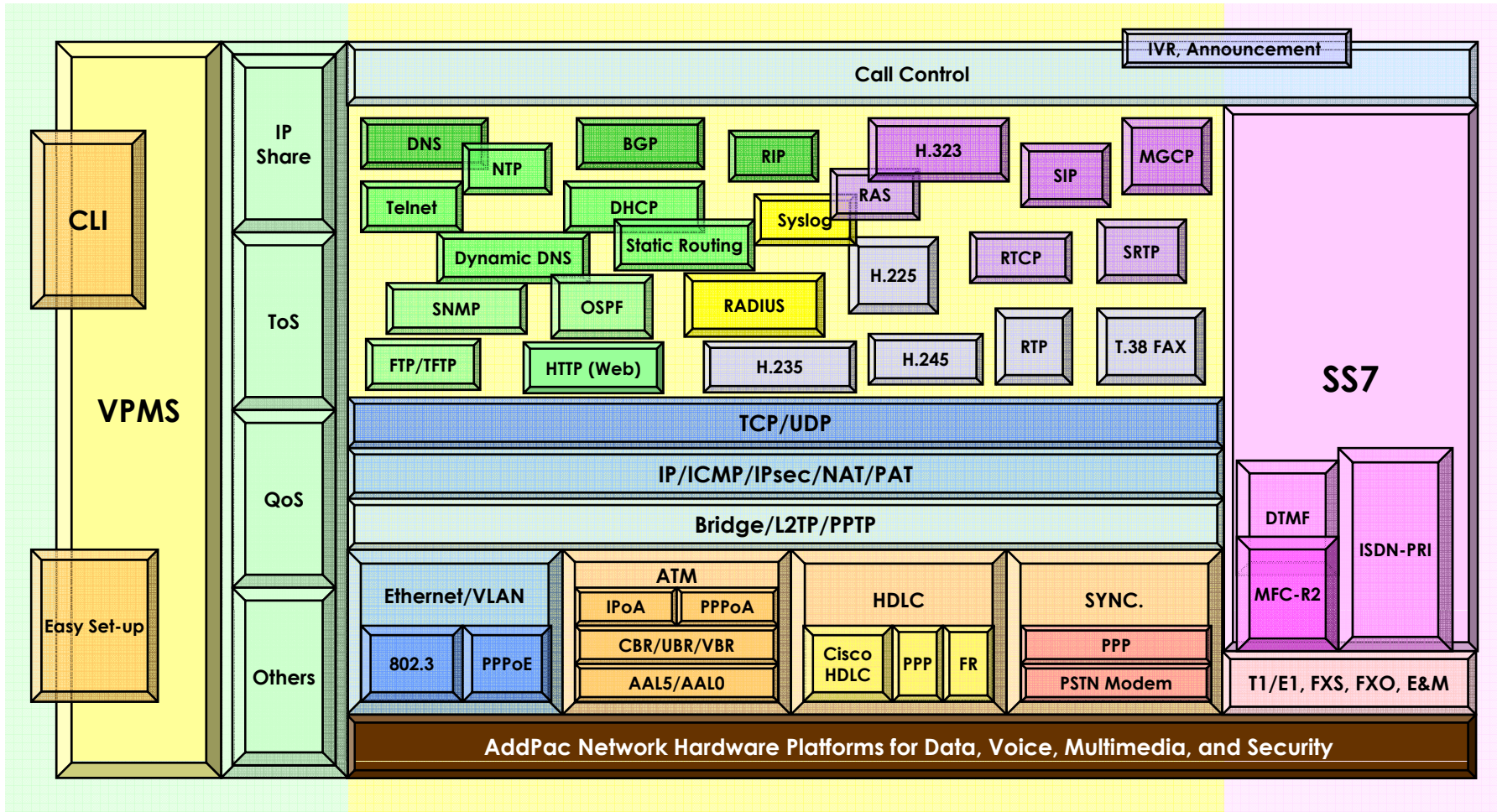

# APOS™ for IP Audio Broadcasting Server

## APOS™ Internetworking SW World (1)

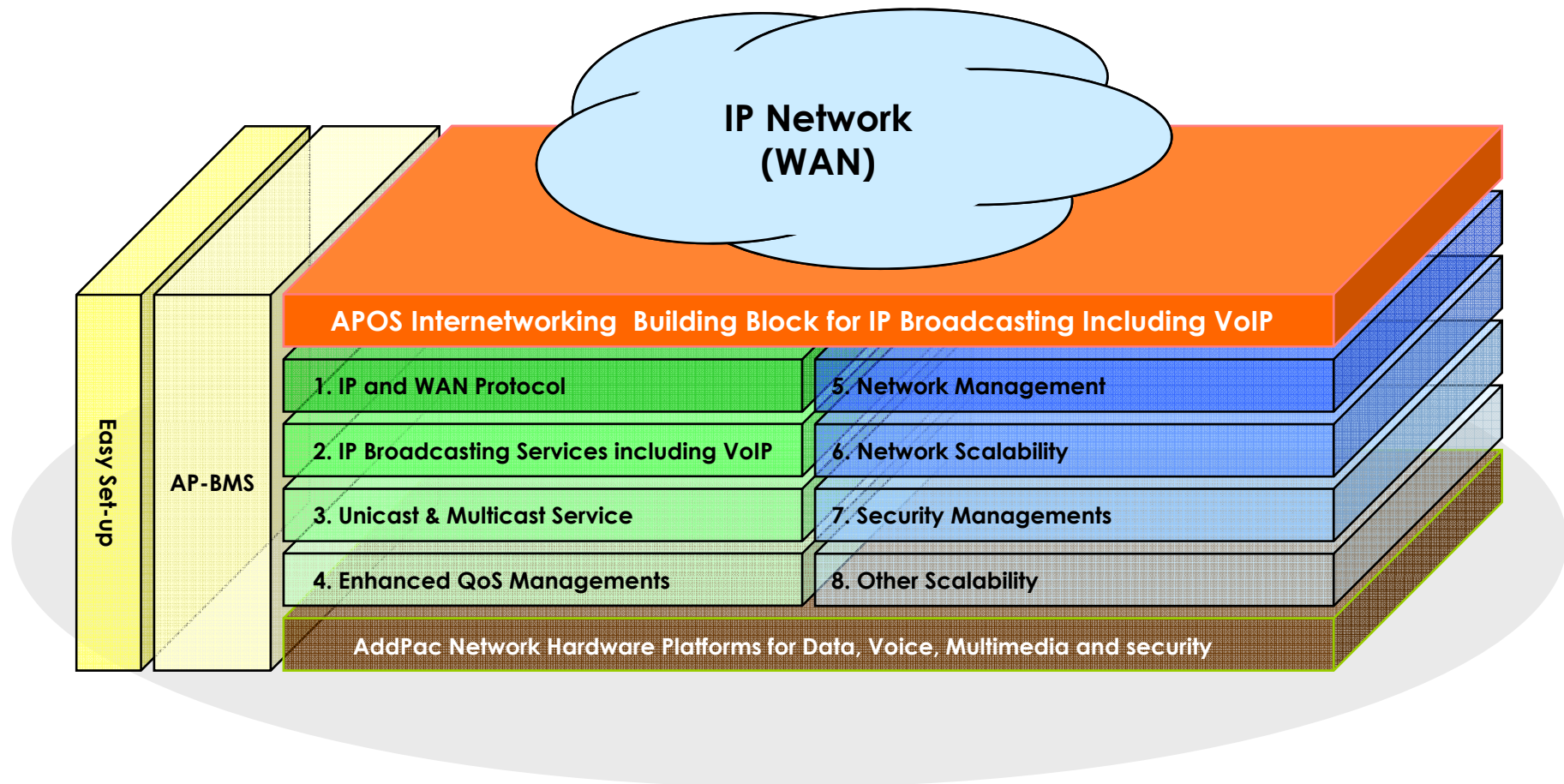

# APOS™ for IP Audio Broadcasting Server

## APOS™ Internetworking SW World (2)

- APOS Internetworking Software World
  - AddPac Operating System (APOS)
  - Support Industry Standard
  - Integrated Networking Protocols
  - Optimized Performance & Functionality
  - Easy to use, Installation, and Maintenance

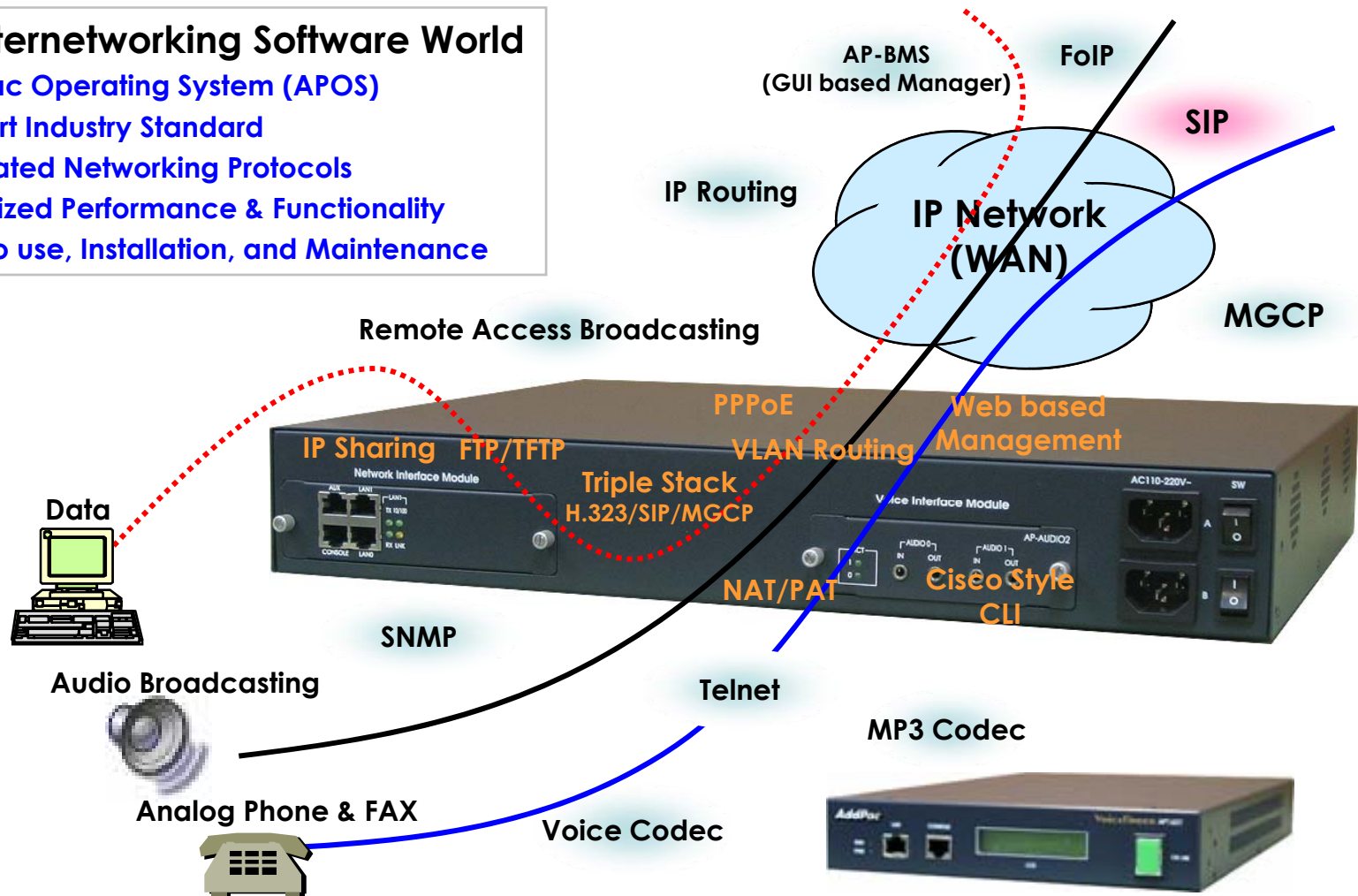

**AddPac**

[www.addpac.com](http://www.addpac.com)

11

# APOS™ for IP Audio Broadcasting Server

## IP and WAN Protocols

- IP Routing Protocols

- Multi-protocol Internetworking Services
- Static & Default IP routing
- RIP v1/v2 (opt.)
- OSPF v2 routing protocols support (opt.)
- Transparent Bridging (IEEE Spanning Tree Protocol)

- WAN Protocols

- Point-to-Point Protocol (PPPoE for ADSL)
- IEEE 802.3 Ethernet
- PPTP support for secure communication

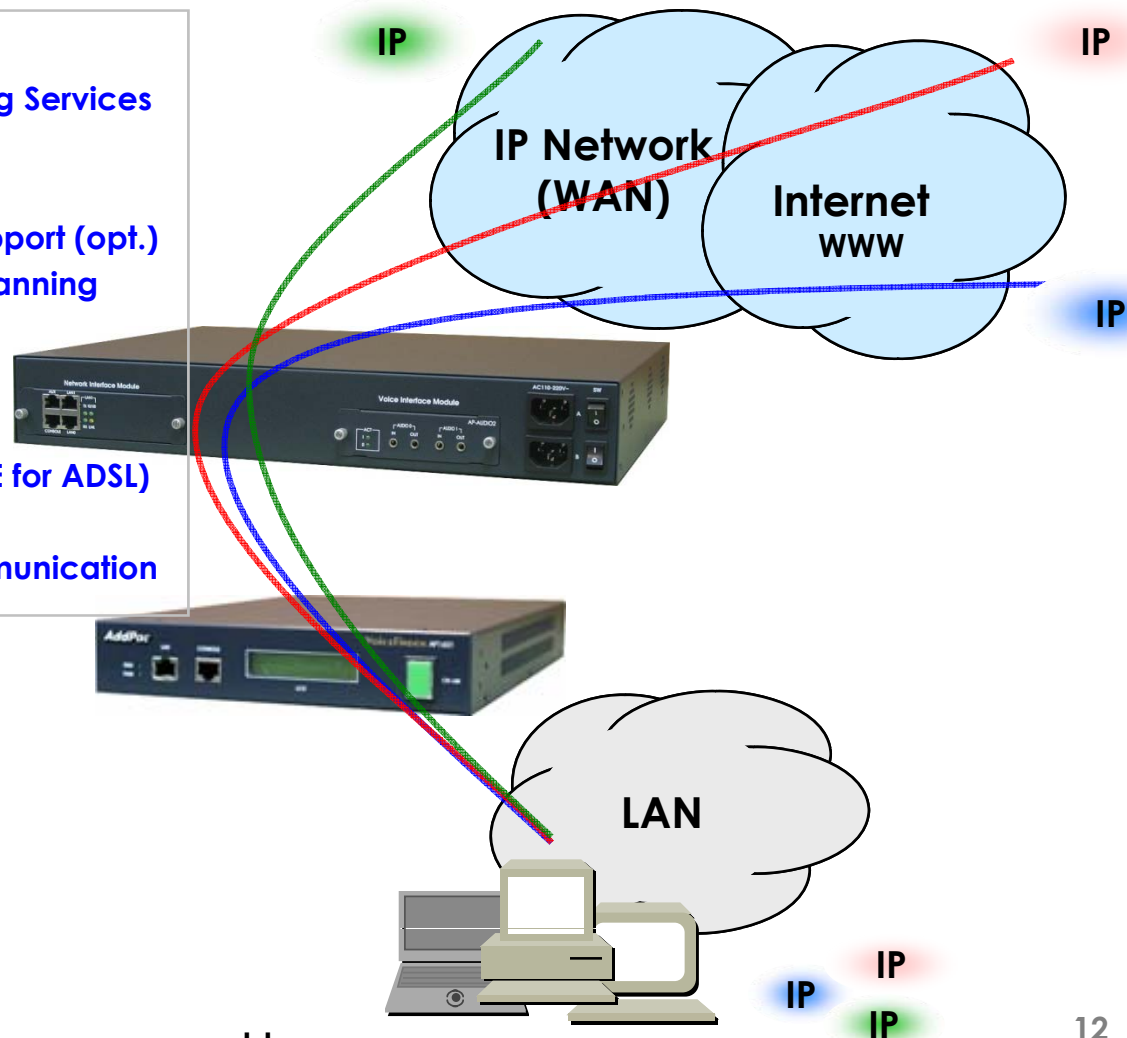

# APOS™ for IP Audio Broadcasting Server

## IP Broadcasting Services Including VoIP (1)

- Voice Codec for AP-AUDIO2 Module

- G.711 A-Law, G.711 U-Law
- G.726 r16, G.726 r32
- G.729A
- G.723.1 r63, G.723.1 r53
- VAD (Voice Activity Detection) function support
- DTMF relay support (H.323, SIP) based on RFC2833

- Audio Codec for AP-MP3 Module

- MP3(MPEG2 Layer3) Audio Codec
- VAD (Voice Activity Detection) function support
- DTMF relay support (H.323, SIP) based on RFC2833

- RTP

- Redundant RTP packet transmission in case of severe packet loss
- Dynamic jitter buffer management and RTP packet jitter and loss compensation with heuristic & DSP error concealment
- Static jitter buffer setting support
- Voice frame per RTP packet number control for each codec
- In-band ring-back tone support
- Virtual ring-back tone support
- Tone parameter change support

VoIP



# APOS™ for IP Audio Broadcasting Server

## IP Broadcasting Services Including VoIP (2)

- H.323
  - ITU-T Standard H.323 v3 Support
  - Support H.245 Tunneling
  - Including H.235 Security Features
- SIP
  - IETF RFC3261 or RFC2543 SIP Standard

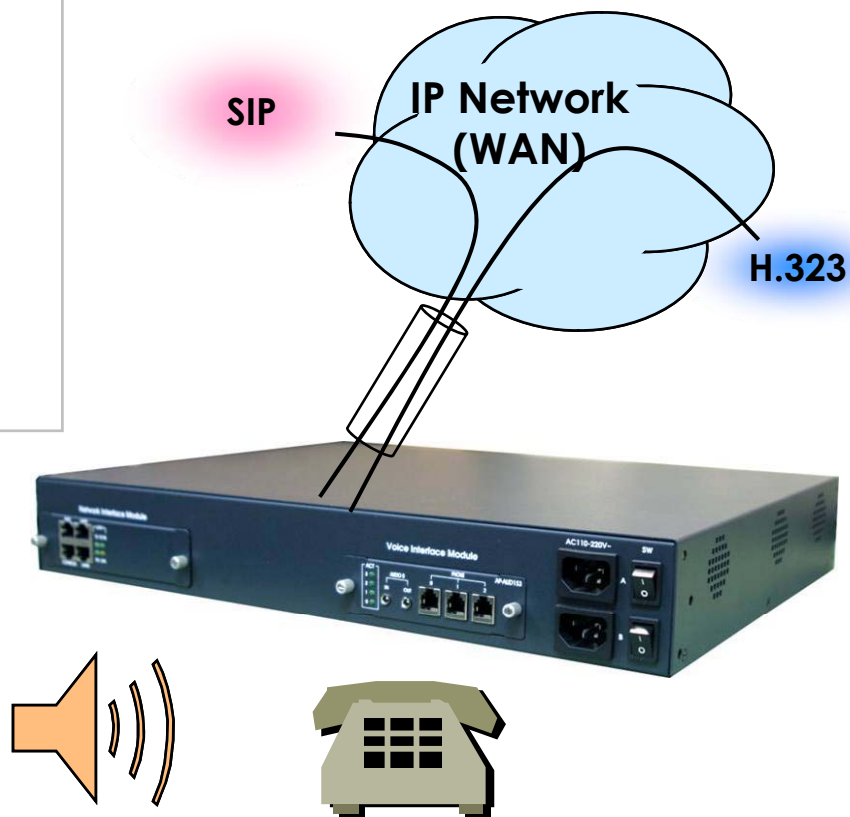

# APOS™ for IP Audio Broadcasting Server

## IP Broadcasting Services Including VoIP (3)

### • H.323

- Fast connect, normal connect support
- H.245 tunneling support
- Q.931 response message setting for inbound VoIP calls
- H.245 logical channel open timing selection function
- Start H.245 procedure support
- DTMF / Hook flash relay with H.245 alphanumeric / signal
- Secondary gatekeeper support
- Gatekeeper assignment according to the domain name
- Gatekeeper discovery with multicast
- Lightweight RRQ support
- Signaling TCP port assignment
- Resource threshold setting with RAI
- H.235 clear-token, crypto-token support
- Can Map Alias support
- Technical prefix (supported prefix) support
- Public IP assignment in NAT environment



### • SIP

- Gateway-based / Endpoint-based registration support
- Secondary proxy-server assignment function
- SIP signaling port change function
- SIP proxy server assignment according to the domain name
- T.38 real-time fax relay support
- DTMF relay support with RFC2833 / OPTION message
- Re-INVITE support

# APOS™ for IP Audio Broadcasting Server

## IP Broadcasting Services Including VoIP (4)

### • VoIP Call Controls

- Hot line connection function with PLAR (Private Line Auto Ring Down)
- Leased line emulation function
- Connection monitoring function
- Fault tolerant with Redundancy and Call Distribution among Gateways for load balancing
- Call attempt with IP address
- H.323, SIP inbound call connection for each voice port
- Multiple E.164 setting for one voice port
- One E.164 or digit pattern can be assigned to more than one voice port
- Hunting with Longest match/ priority/ sequence/ random
- One stage call setup by Digit forwarding
- Call barring with specific digit patterns
- Calling and called number conversion for PSTN outbound calls
- PSTN rerouting in case of VoIP call attempt failure

### • VoIP Call Controls (cont.)

- Call transfer for internal calls
- Call pickup for internal calls
- Calling and called number conversion for VoIP outbound calls
- Calling and called number conversion for VoIP inbound calls
- Fax broadcasting call control

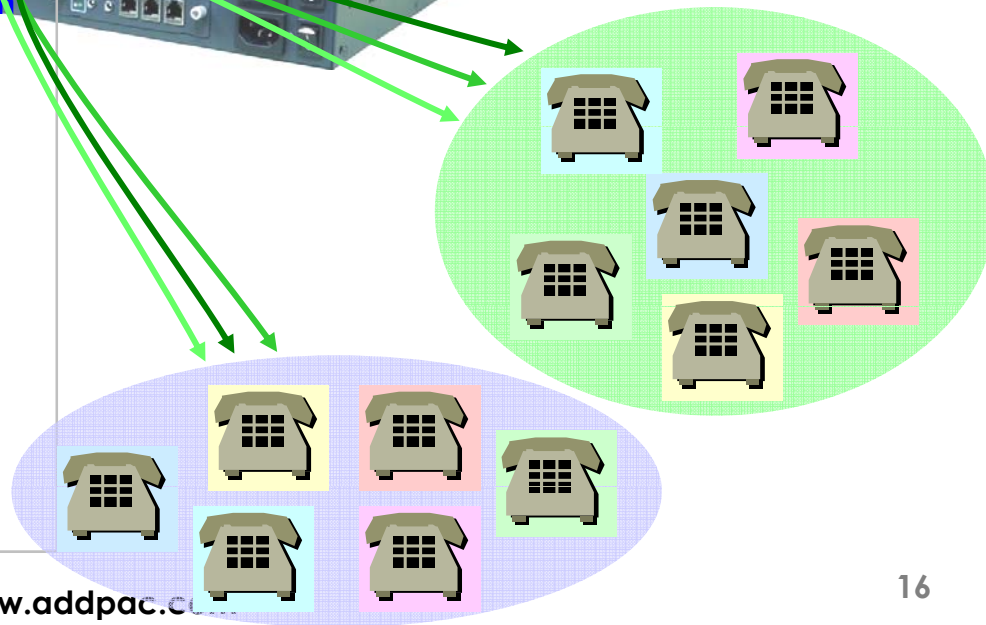



# APOS™ for IP Audio Broadcasting Server

## Unicast & Multicast Service

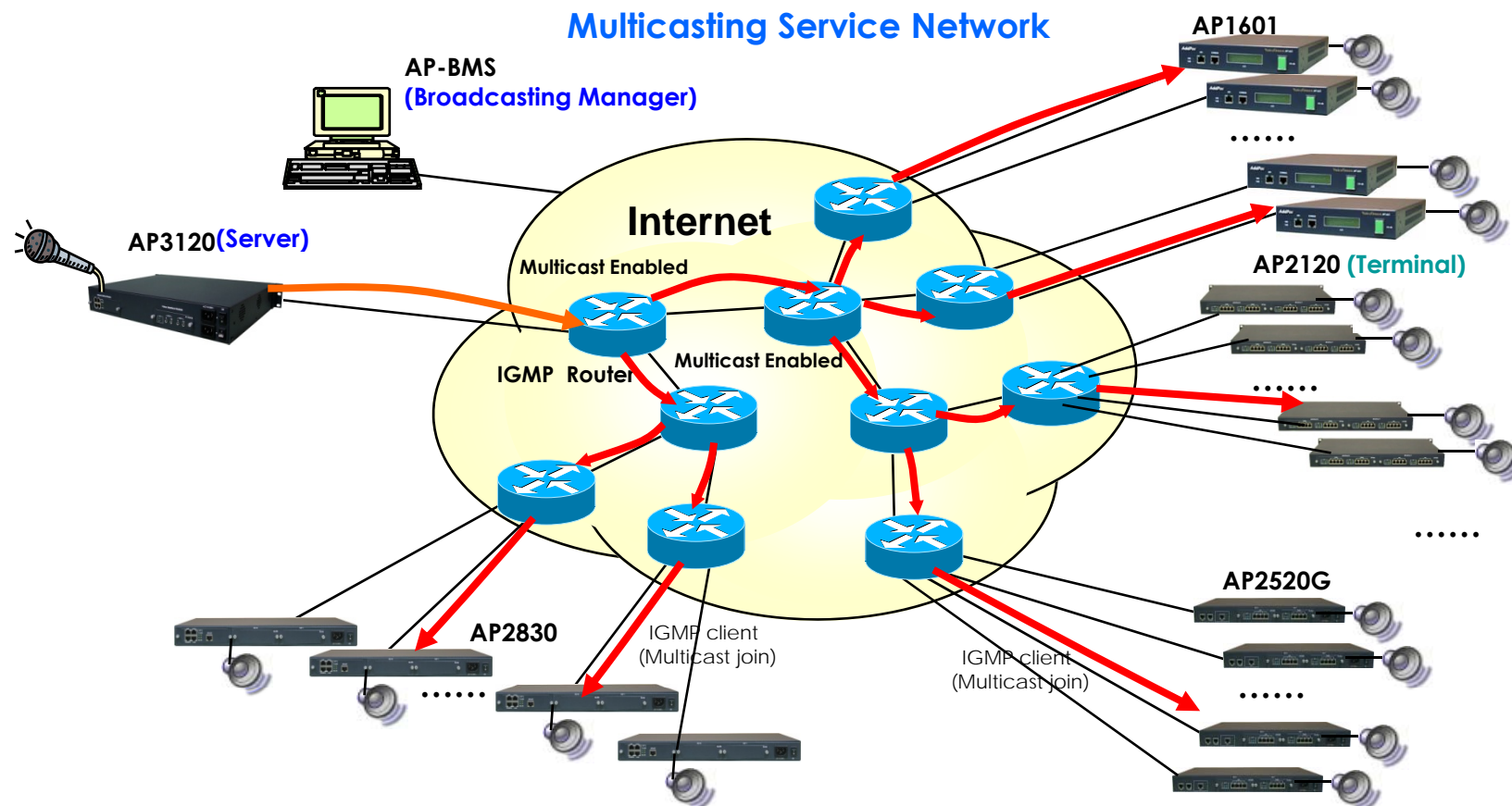

- Multicast protocol based such as **IGMP Protocol**
- Available to broadcast multi destination with single channel bandwidth

# APOS™ for IP Audio Broadcasting Server

## Unicast & Multicast Service

### Unicasting Service Network

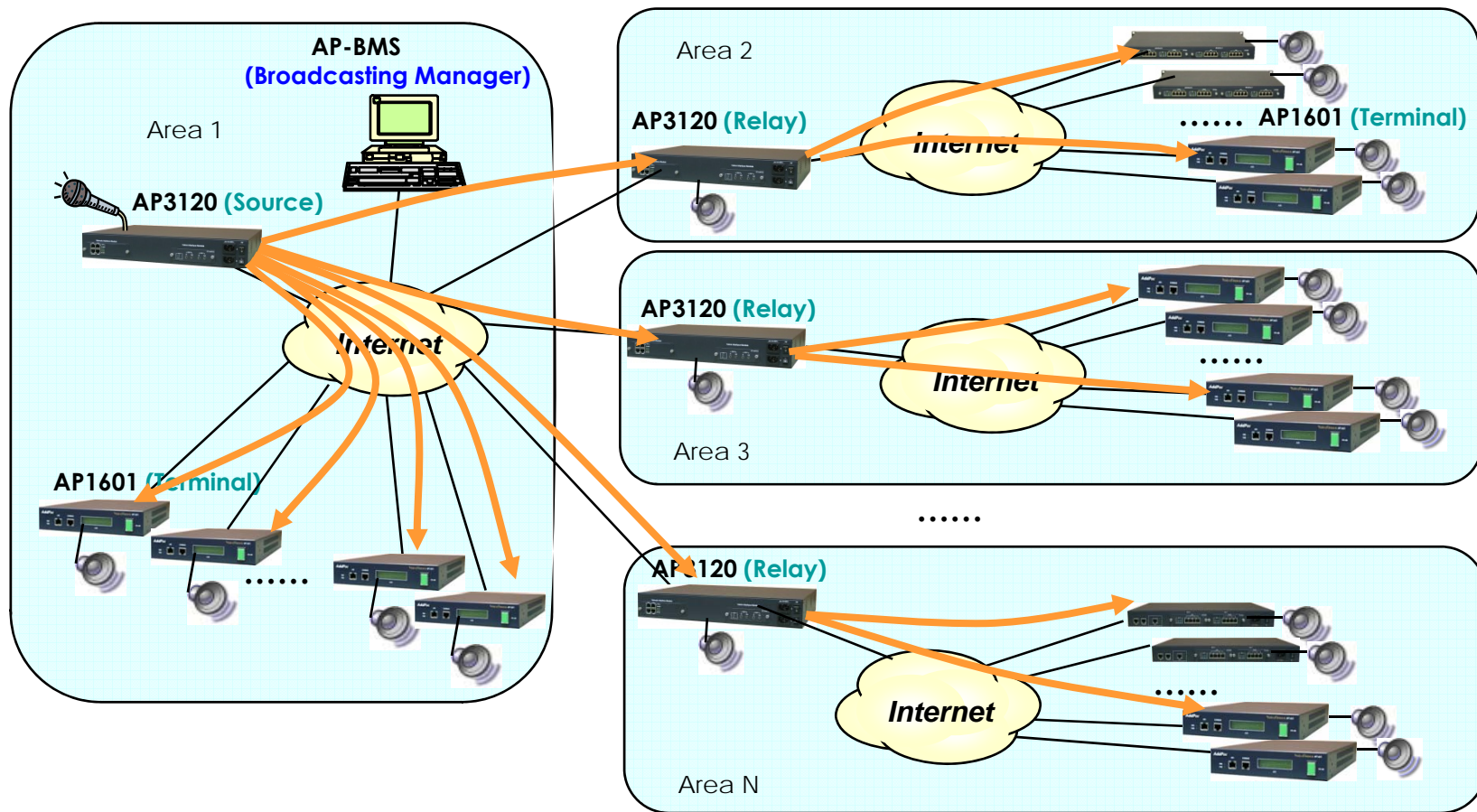

# APOS™ for IP Audio Broadcasting Server

## Enhances QoS Managements(1)

- Enhances **Transmit** Voice QoS Features

- Voice Traffic Priority Queuing
- QoS Service Profiling
- Providing Virtual Network Transmit Algorithm
- Real-time Voice Traffic QoS Support
- RTP Packet Transmit Interval Control
- Supporting RTP Packet Redundancy Scheme
- IP Header Control such as ToS, Diffserv

- Enhances **Receive** Voice QoS Features

- Dynamic Jitter Buffer Management
- Error Concealment
- Support T.38 FAX Data Error Recovery Scheme

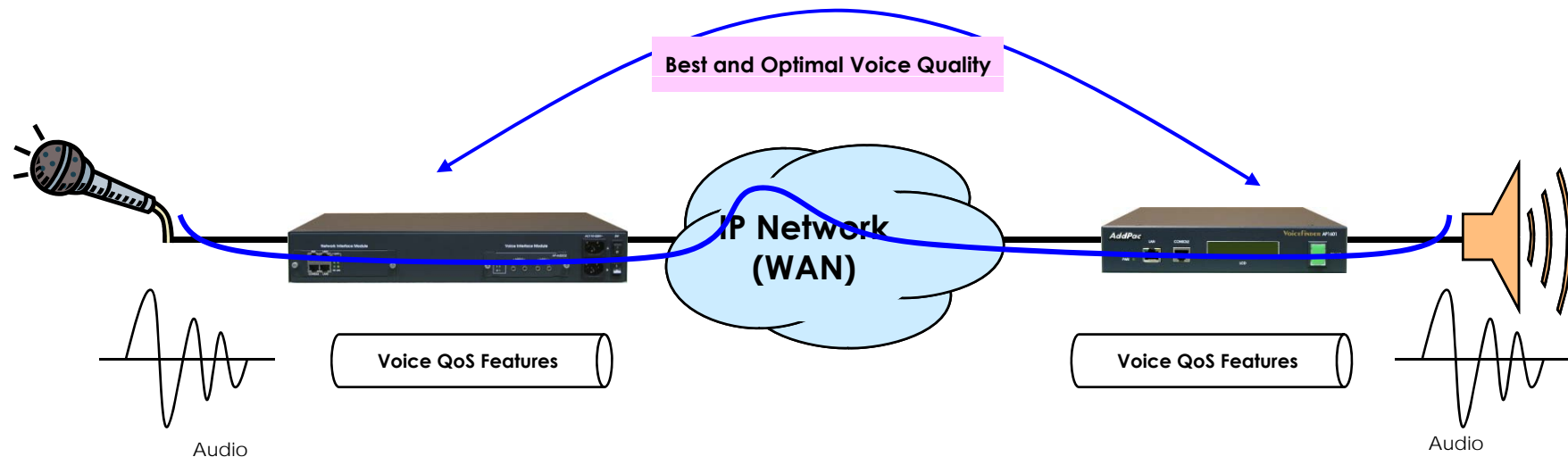

# APOS™ for IP Audio Broadcasting Server

## Enhances QoS Managements (2)

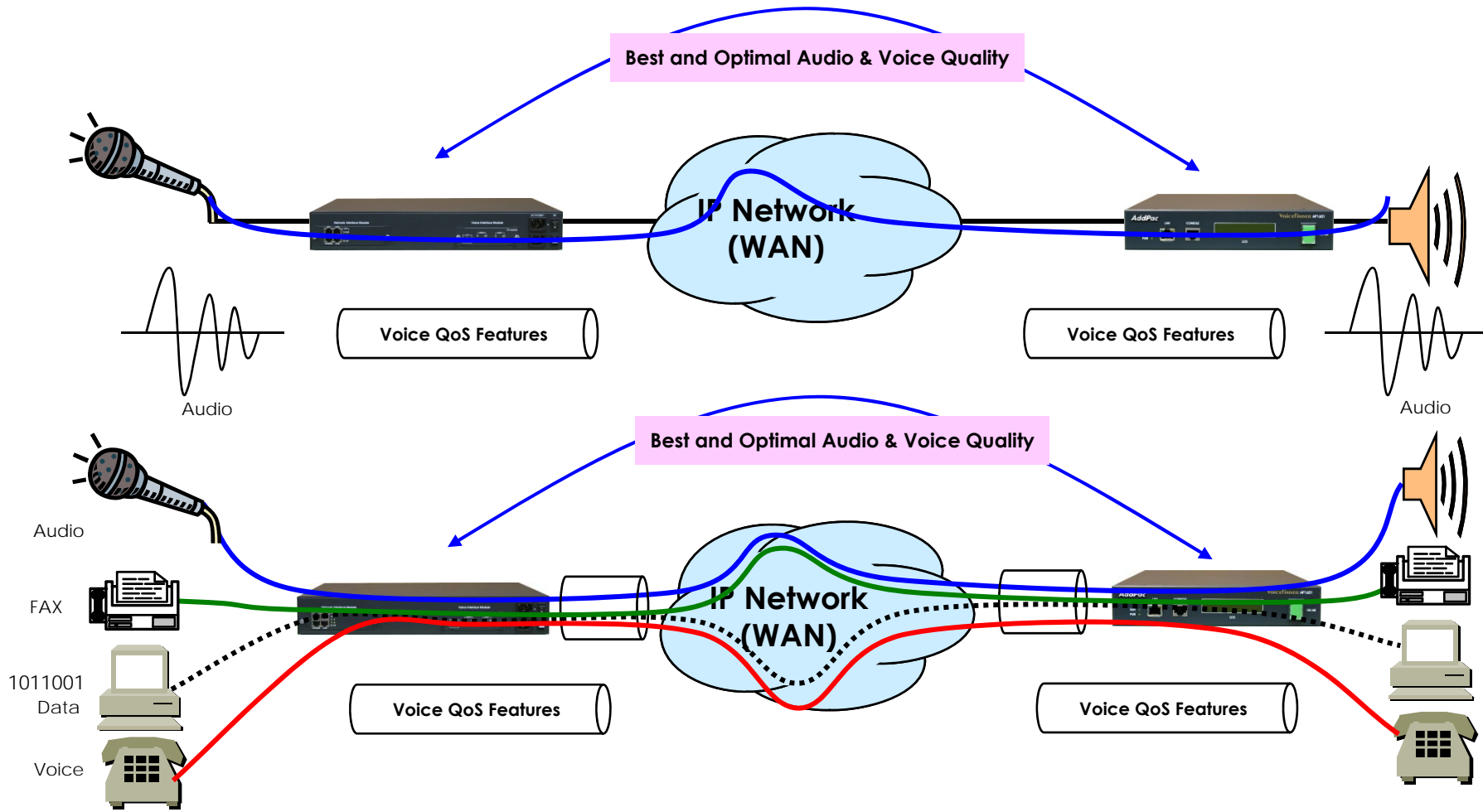

**AddPac**

[www.addpac.com](http://www.addpac.com)

20

# APOS™ for IP Audio Broadcasting Server

## Network Managements

- **SNMP**

- Standard Simple Network Management Protocol( SNMP) Agent support
- MIB v1 and v2 Support

- **Web-based Management**

- Standard Voice & Audio Interface

- **Watch-dog Function**

- Hardware, Software watch-dog services

- **Remote Management**

- Telnet
- Rlogin
- Console

- **Auto Upgrade Service**

- HTTP server based APOS image and configuration file auto-upgrade support

- **Batch Job Function**

- Text based script downloading

- **AP-BMS**

- MS Windows Graphical User Interface (GUI) based Audio Broadcasting Management
- Service Group Configuration
- Scheduled Broadcasting
- Status Monitoring
- Report Service
- Embedded Media file Manager

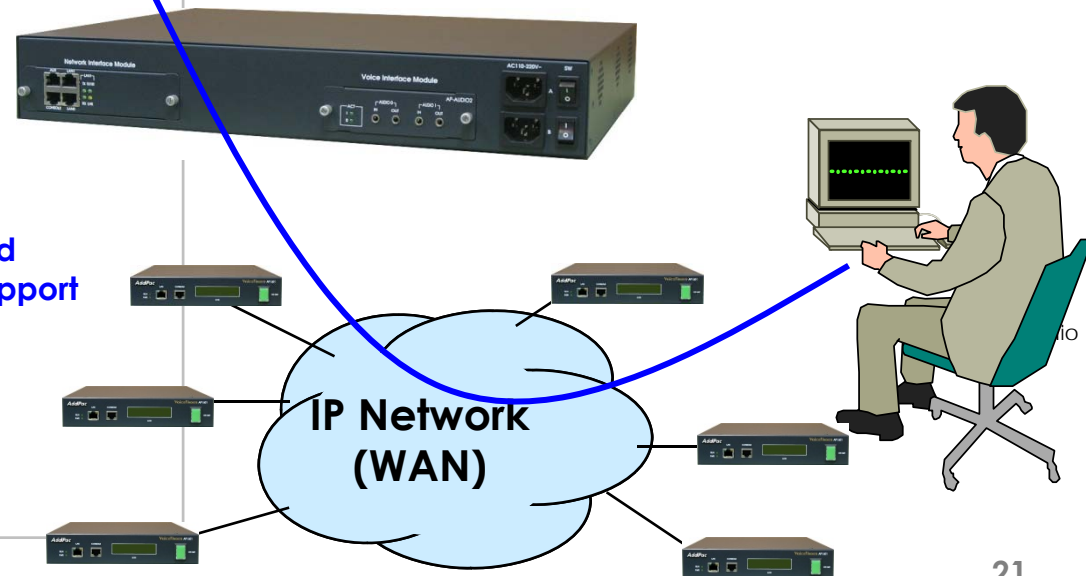

**AddPac**

[www.addpac.com](http://www.addpac.com)

21

# APOS™ for IP Audio Broadcasting Server

## Network Scalability (1)

- IP Sharing Feature

- Single IP Address, Multiple IP Network Access
- Public IP Address Sharing by AP3120

- IP Sharing Network Environment

- Support Legacy Network Environment
- xDSL Modem based Broadband Network
- Cable Modem based Broadband Network
- Leased line Network Environment

- Both support Fixed and Dynamic IP

- Support Standard Network Protocols

- PPPoE
- PPPTP
- DHCP

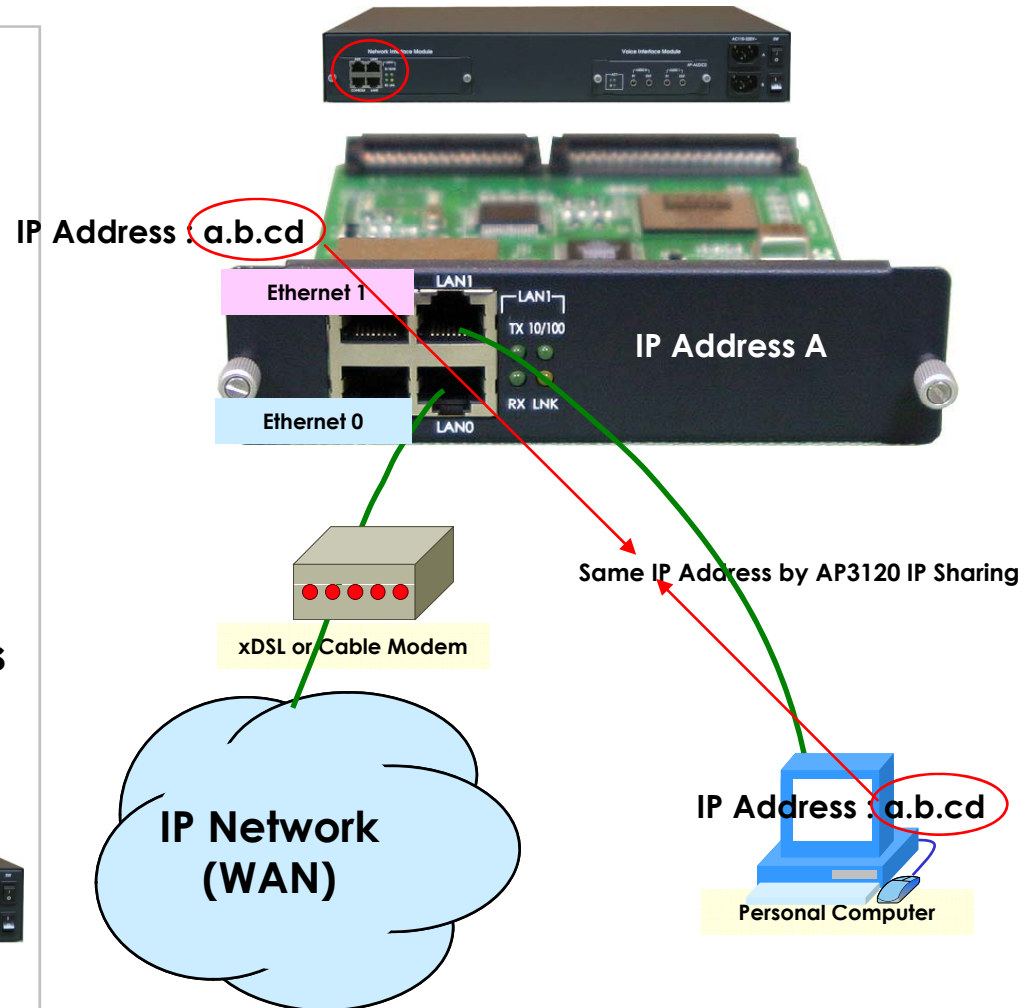

# APOS™ for IP Audio Broadcasting Server

## Network Scalability (2)

- **Bridging Service**
  - Spanning Tree Bridging protocol (IEEE) support
- **DHCP**
  - Server and Relay
- **IP Accounting**
- **PAT (Port Address Translation)**
- **NAT (Network Address Translation)**
- **Cisco Style CLI (Command Line Interface)**
- **PPTP (Point-to-Point Tunneling Protocol)**
- **NTP (Network Time Protocol)**
- **FTP/TFTP**
  - Server and Client support
- **DNS / DDNS**
  - Dynamic DNS Client support

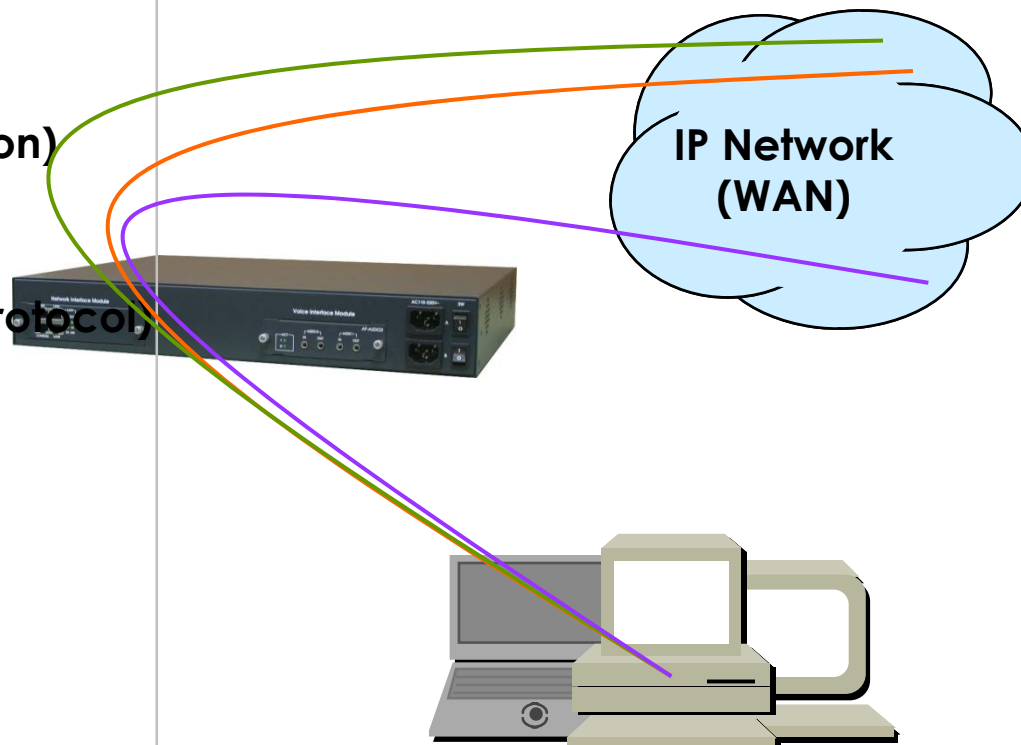

# APOS™ for IP Audio Broadcasting Server

## Security Managements (1)

- IP packet filtering
- IP access list
- User authentication function
  - PAP / CHAP
- Enable/Disable specific protocols
- Auto-square connect of console and Telnet session
- Account Management function for multi-level user
- SNMP/TELNET/FTP/HTTP/TFTP port assignment function
- SNMP/TELNET/FTP access list management
- Boot mode security checking function
- IVR based Access Control via Phone & Cellular Phone

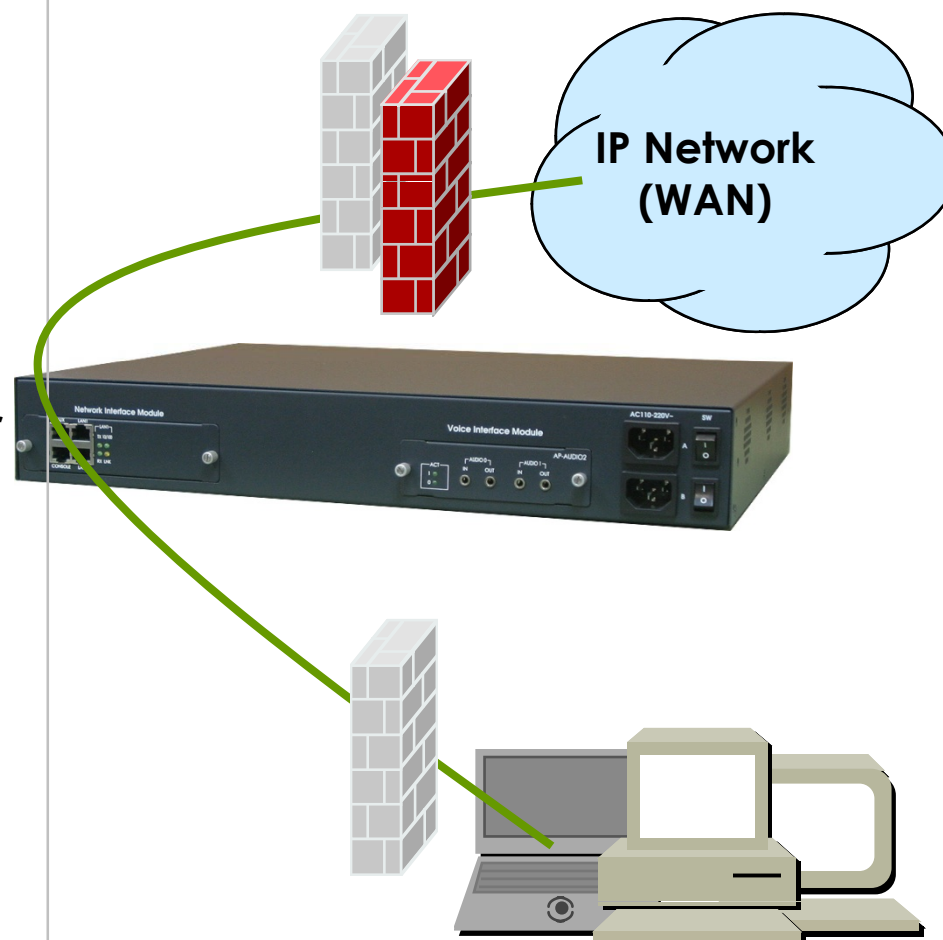



# APOS™ for IP Audio Broadcasting Server

## Security Managements (2)

- IVR based Access Control via PSTN phone & cellular phone
- Password based Access Control
- Available to select Broadcasting Point

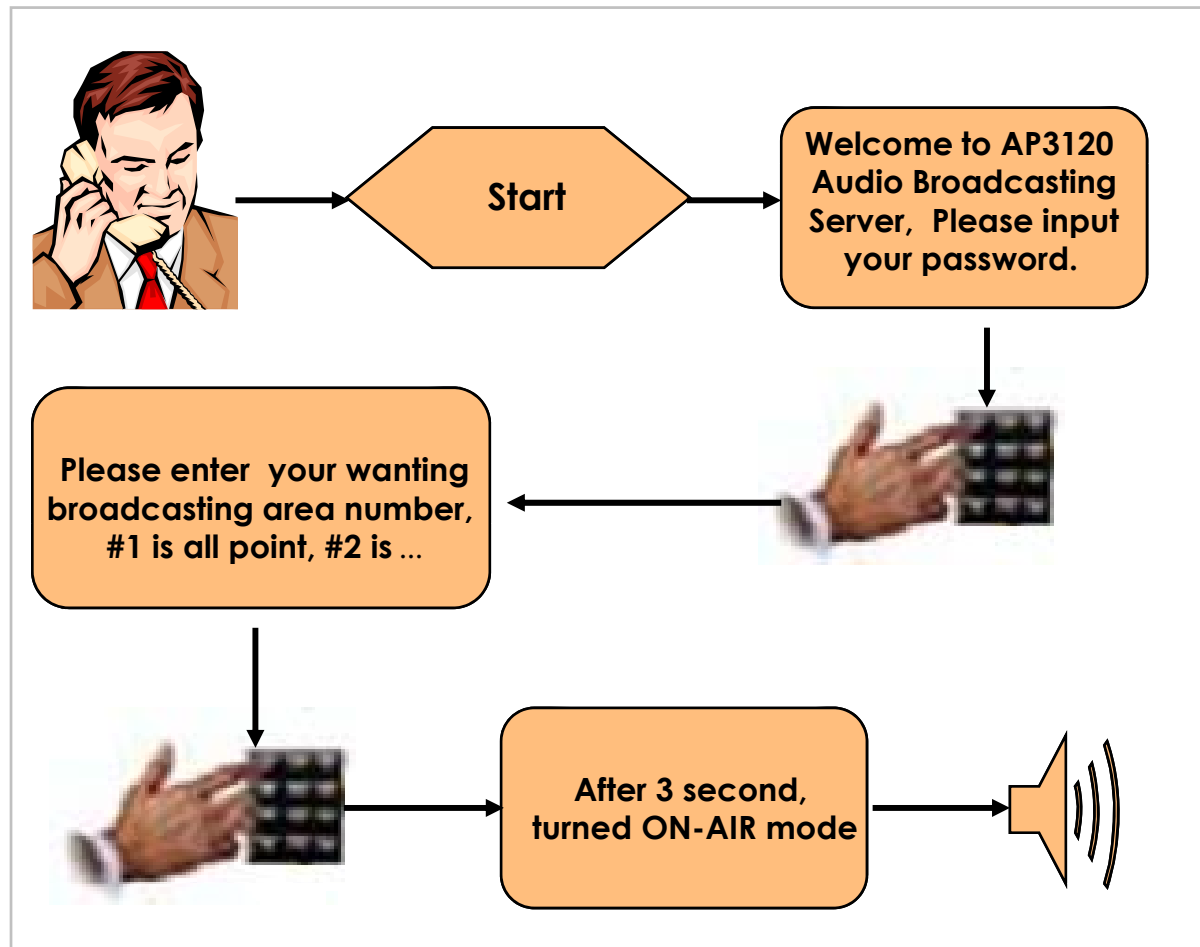

# The Vision of Next Generation Audio Broadcasting

## AP3120 System Overview



# AP3120 System Overview

## AP3120 Network Interface (1)

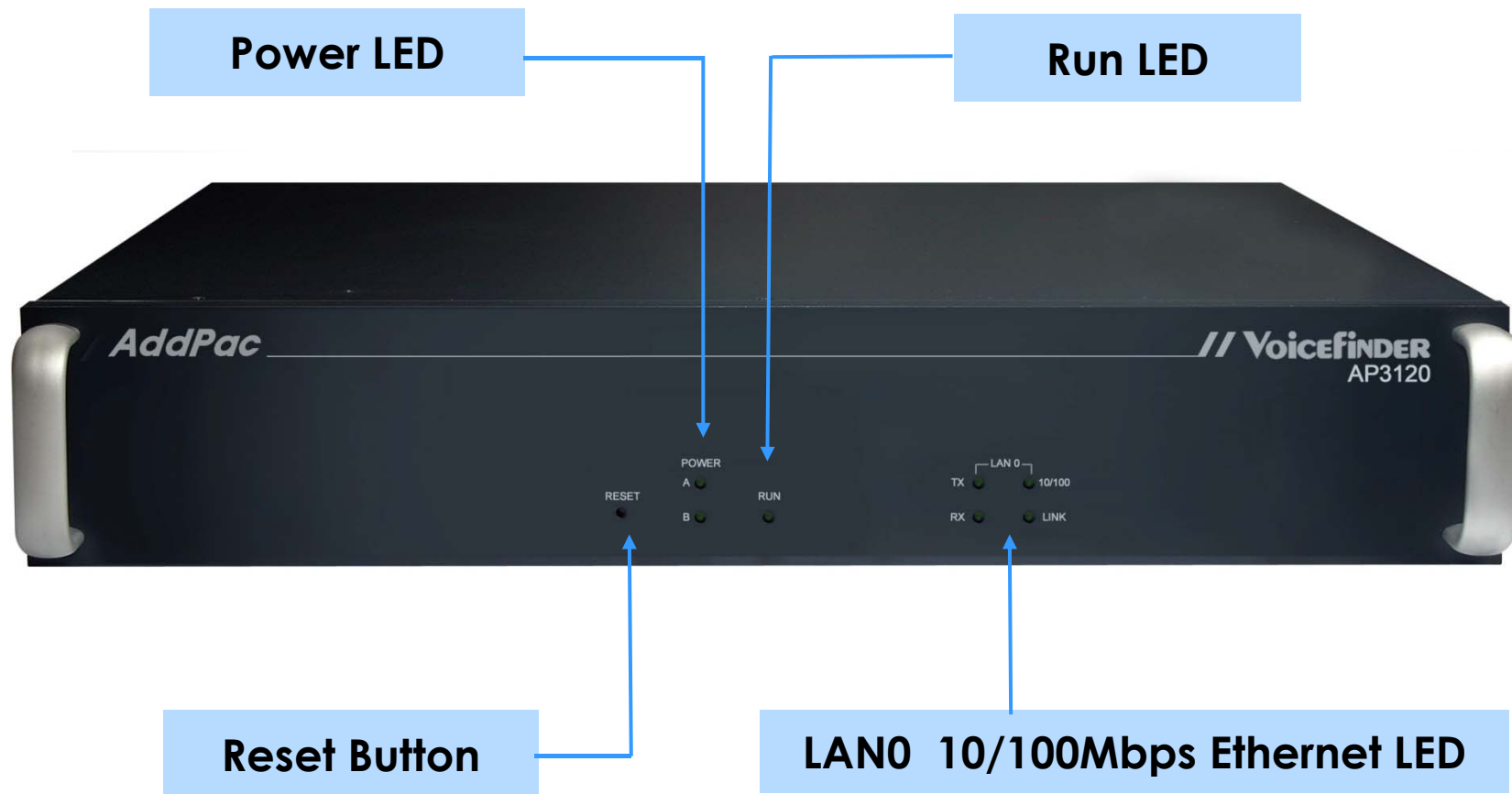

# AP3120 System Overview

## AP3120 Network Interface (2)

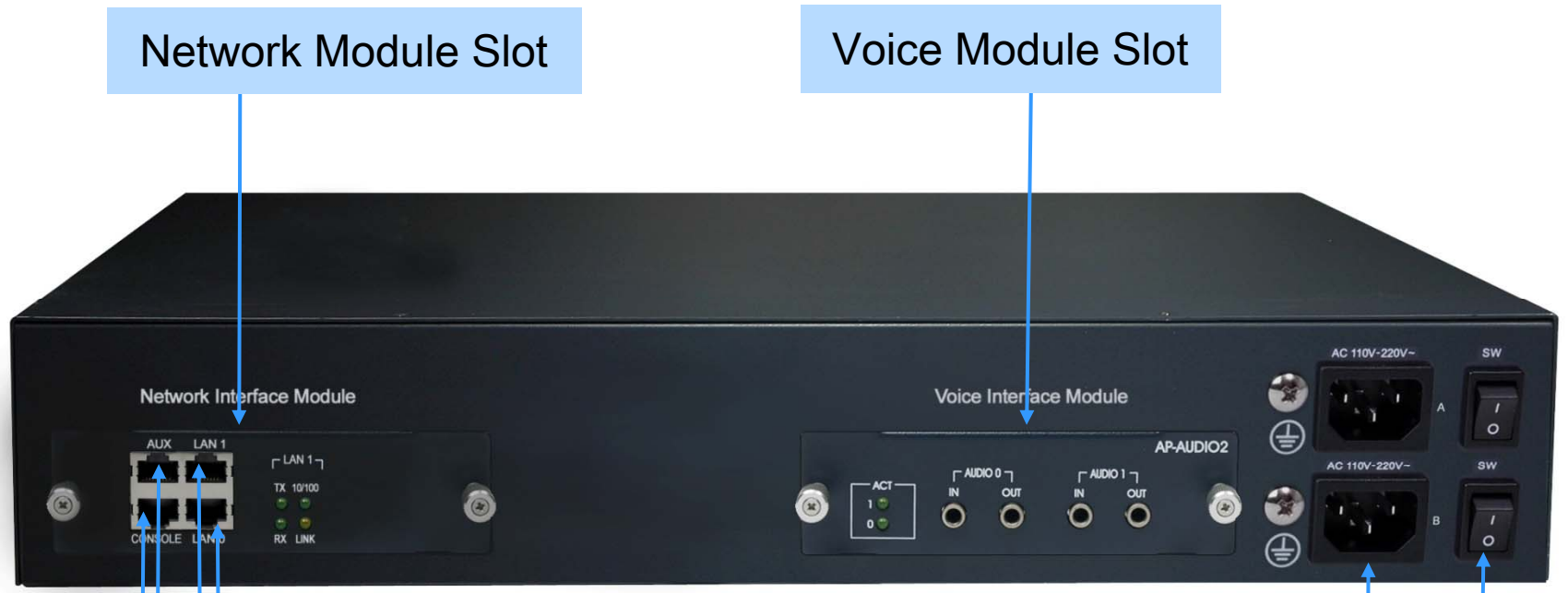

Network Module Slot

Voice Module Slot

LAN0 10/100Mbps Ethernet

LAN1 10/100Mbps Ethernet

Console Port

Console Port

Switch

Dual Power Interface

# AP3120 System Overview

## AP3120 Analog Interface Module (1)

- ❑ Support Various VoIP Module



**AddP**

- 2-Pair Audio-In/Out Ports
- Voice Band IP Broadcasting

- 1-Pair Audio-In/Out Ports, FXS Analog Interface
- Voice Band IP Broadcasting

- 1-Pair Audio-In/Out Ports, FXS 2-Ports, FXO 1-Port
- Voice Band IP Broadcasting

# AP3120 System Overview

## AP3120 Analog Interface Module (2)

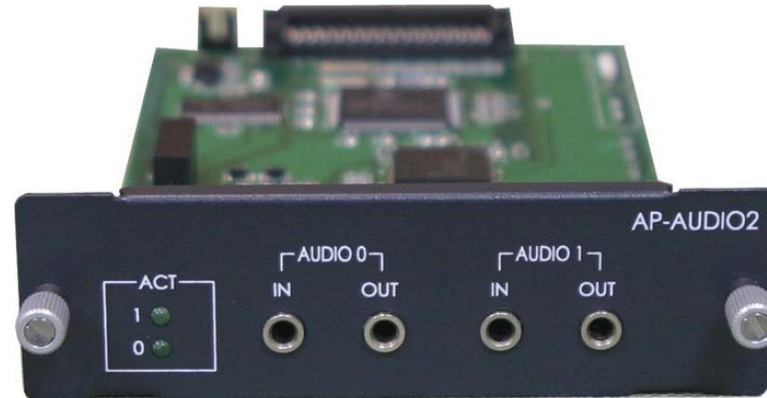

AP-AUDIO2



AP-AUD1S3



AP-AUD1S201

# AP3120 System Overview

## Analog Interface Module Connectivity (1)

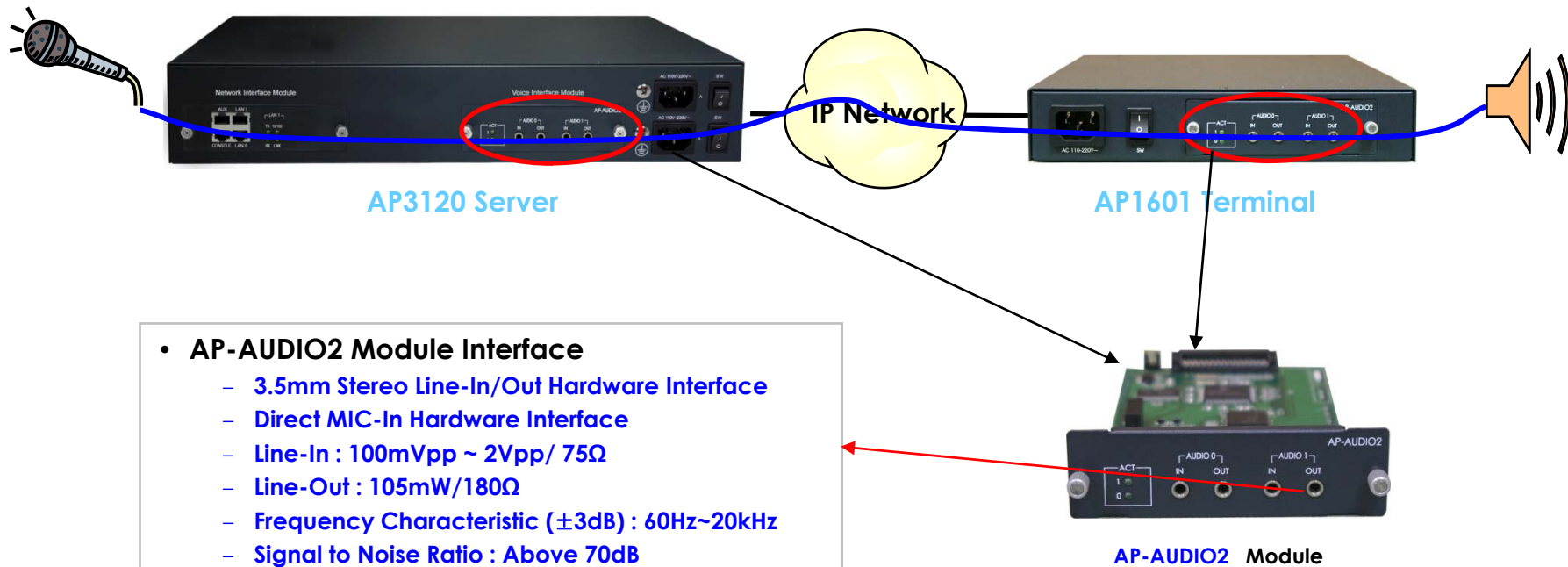

# AP3120 System Overview

## Analog Interface Module Connectivity (2)

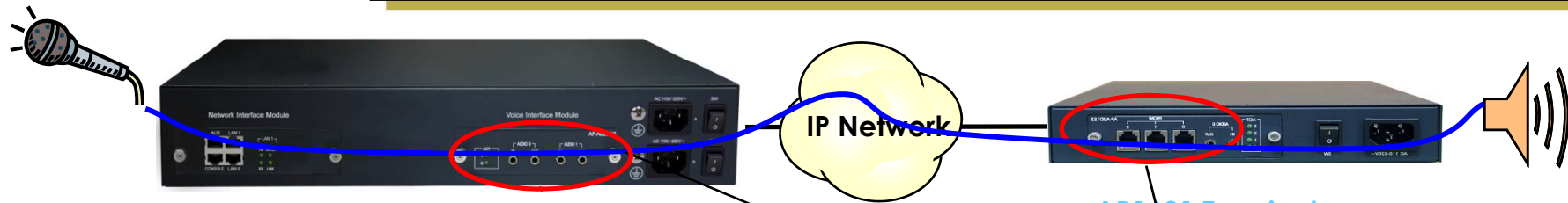

AP3120 Server

AP1&01 Terminal

- **AP-AUD1S2O1 Module (AUD1 Interface)**
  - 3.5mm Stereo Line-In/Out Hardware Interface
  - Line-In : 100mVpp ~ 2Vpp/ 75Ω
  - Line-Out : 105mW/180Ω
  - Frequency Characteristic (±3dB) : 60Hz~20kHz
  - Signal to Noise Ratio : Above 70dB
- **AP-AUD1S2O1 Module (2FXS Port Interface)**
  - RJ-11 Hardware interface
  - Polarity inverse generation function
  - Caller-id generation function
  - Busy-out function support
  - Ring cadence setting function
  - Ring frequency setting function
  - European type II telephone support
  - Surge protect support

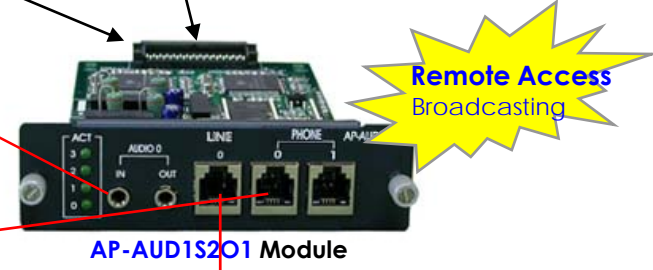

AP-AUD1S2O1 Module

- **AP-AUD1S2O1 Module (1FXO Port Interface)**
  - Polarity inverse detection function
  - Caller-ID detection function
  - Busy-out function support
  - Clear down tone registration and detect function
  - Hook flash timing setting function
  - Ring detect timeout setting function
  - Ring number setting function
  - RJ-11 Hardware interface



# AP3120 Overview

## Analog Interface Module Connectivity (3)

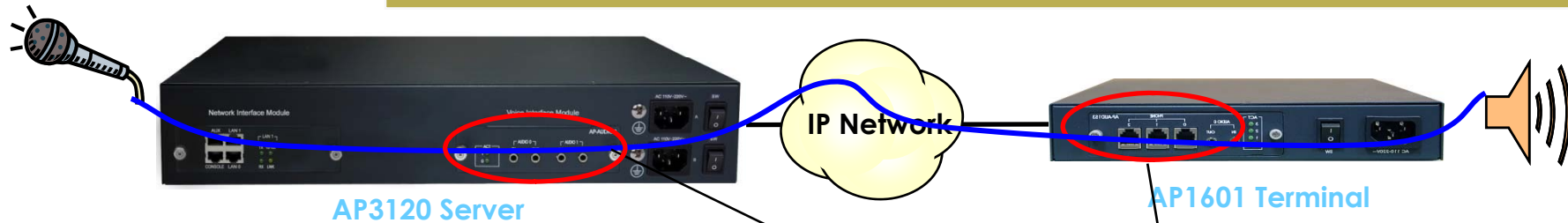

- **AP-AUD1S3 Module (AUD1 Interface)**
  - 3.5mm Stereo Line-In/Out Hardware Interface
  - Line-In : 100mVpp ~ 2Vpp/ 75Ω
  - Line-Out : 105mW/180Ω
  - Frequency Characteristic ( $\pm 3\text{dB}$ ) : 60Hz~20kHz
  - Signal to Noise Ratio : Above 70dB
- **AP-AUD1S3 Module (3FXS Port Interface)**
  - RJ-11 Hardware interface
  - Polarity inverse generation function
  - Caller-id generation function
  - Busy-out function support
  - Ring cadence setting function
  - Ring frequency setting function
  - European type II telephone support
  - Surge protect support

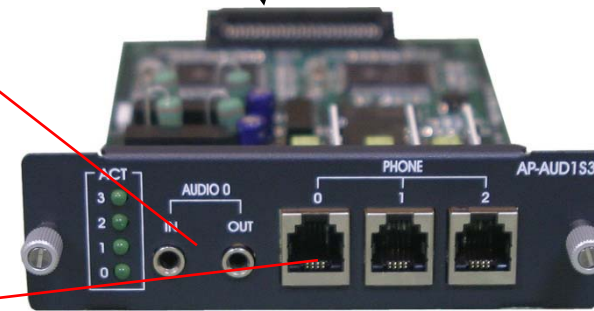

AP-AUD1S3 Module

# AP3120 System Overview

## AP3120 Client Side Terminal Series

- AP1601 Terminal



- AP2110 VoIP Gateway



- AP2520 VoIP Gateway



- AP2830 ATM Multi Service



- AP2850 ATM Multi Service



AP-Audio2



AP-AUD1S3



AP-AUD1S2O1

**AddPac**

[www.addpac.com](http://www.addpac.com)

# AP3120 System Overview

## Server-AP1601 Terminal Matching

### AP3120 Broadcasting Server



### AP1601 Broadcasting Terminal

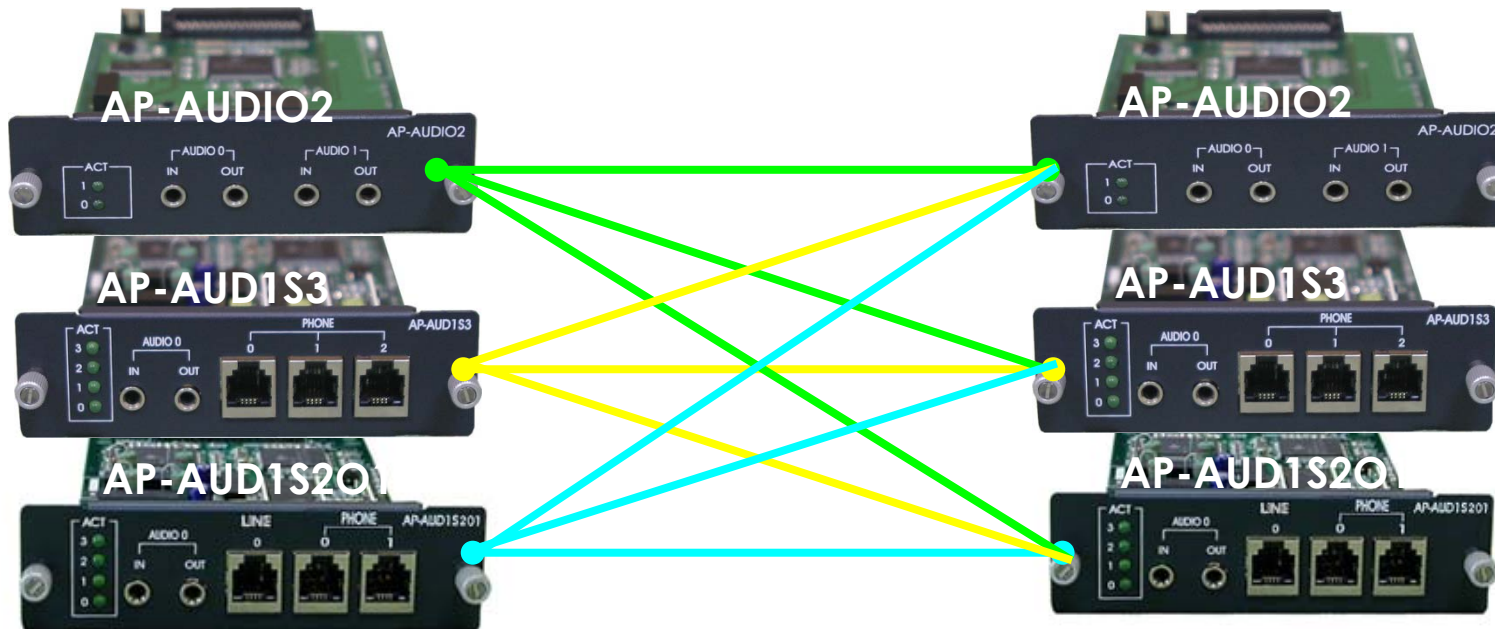

**Add**

[www.addpac.com](http://www.addpac.com)

# The Vision of Next Generation Audio Broadcasting

## AP3120 System Configuration



# AP3120 System Configuration

## AP-AUDIO2 Module Configuration

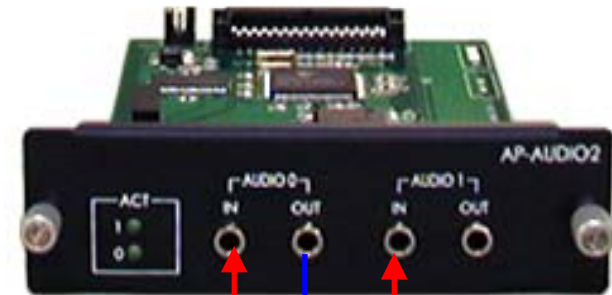
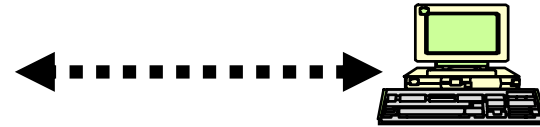
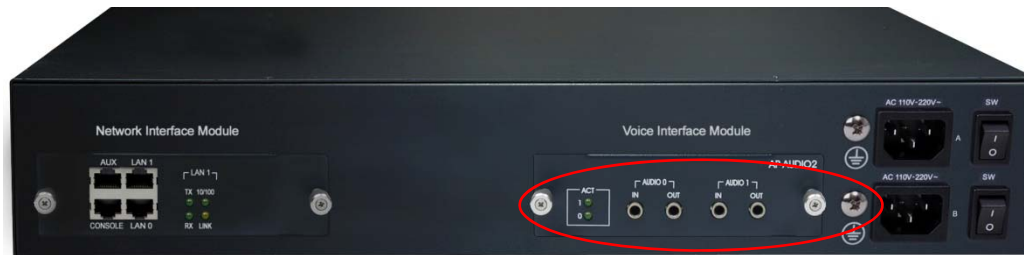

Direct Mic-In

Connect with 1:2 Stereo Jack

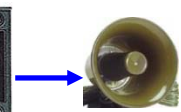

### Audio Module HW Specification

Line-In	100mVpp ~ 2Vpp/ 75Ω
Line-Out	105mW/180Ω
Frequency Characteristic (±3dB)	60Hz~20kHz
Signal to Noise Ratio	Above 70dB
Dimension (WHD)	111×32×160mm

**AddPac**

www.addpac.com

# AP3120 System Configuration

## AP-AUDIO2 Network

- 2-Pair Audio-In/Out Ports
- 3.5mm Female Analog Interface
- Available to receive & send 2-Channels Broadcasting
- Support Voice Level IP Audio Broadcasting
- Sampling Rate: 8Khz

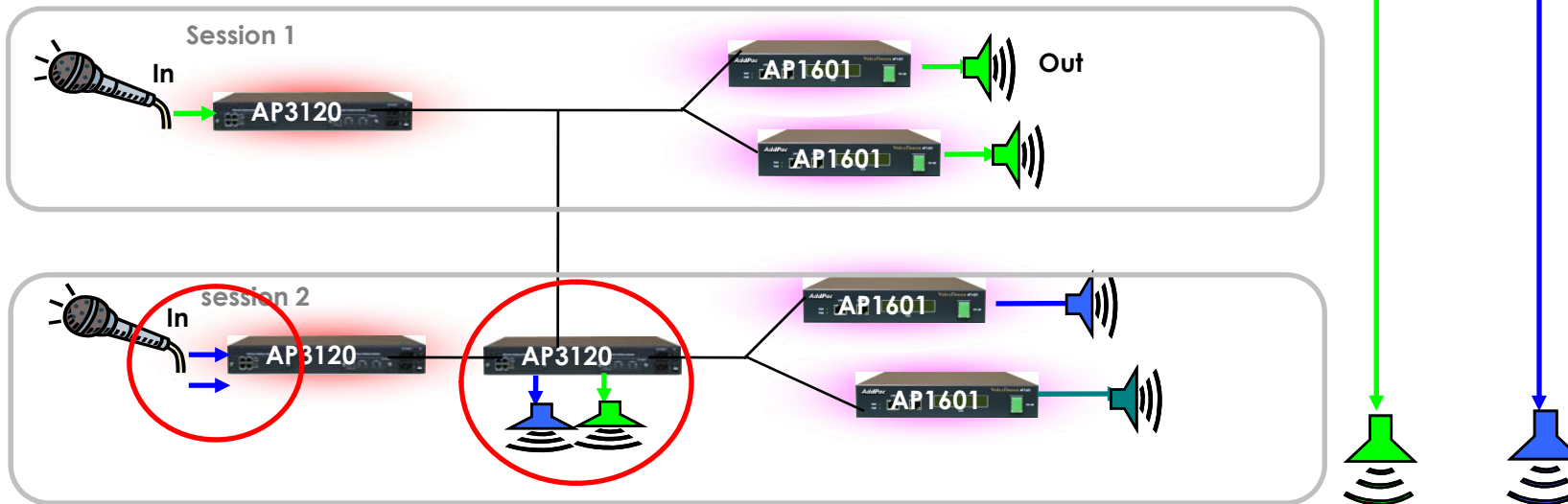

# AP3120 System Configuration

## AP-AUD1S3 Module Configuration

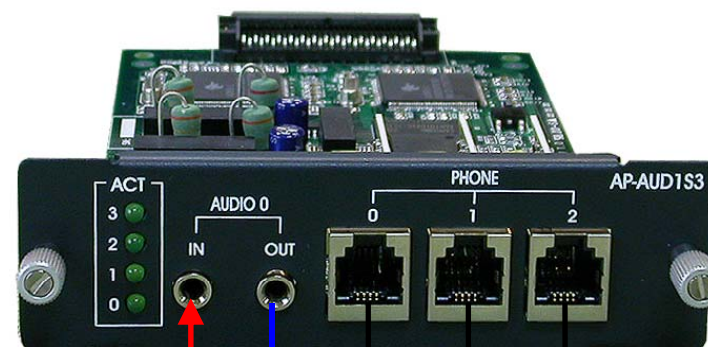

- 1-Pair Analog Audio-In/Out
- 3.5mm Female Stereo Audio Ports
- 3-Ports FXS Analog Interface for VoIP Services
- Realized Integrated Multi Terminal Service
- Support Audio Broadcasting and FAX Broadcasting including VoIP Services

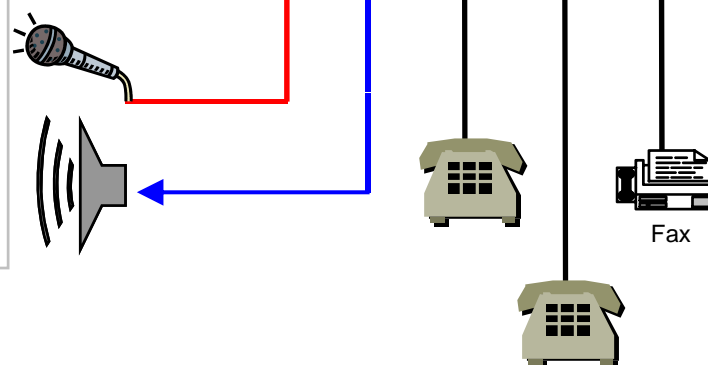

# AP3120 System Configuration

## AP-AUD1S3 Network Configuration

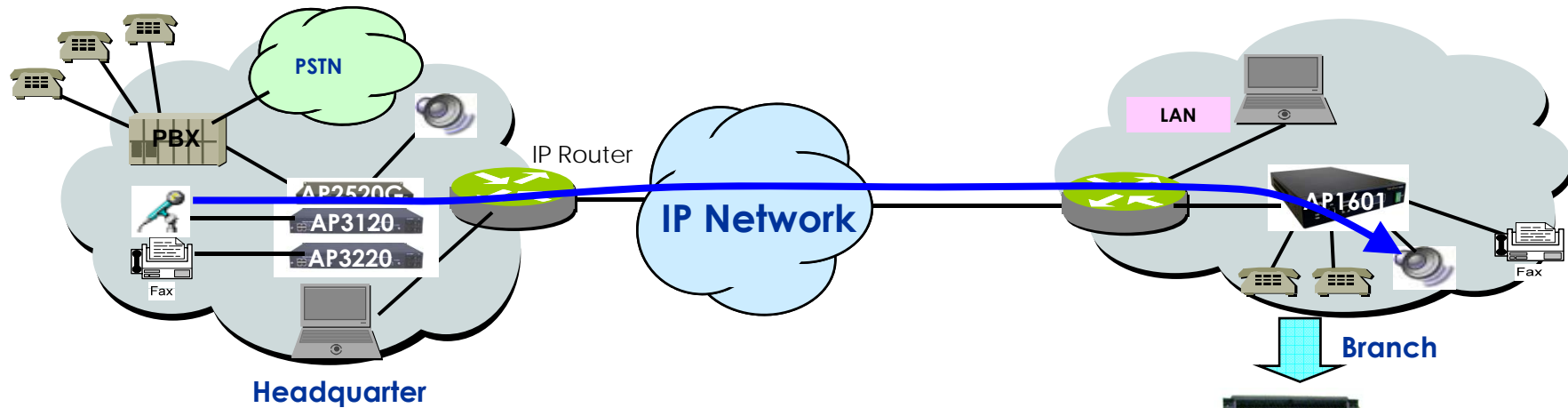

Connect with 1:2 Stereo Jack

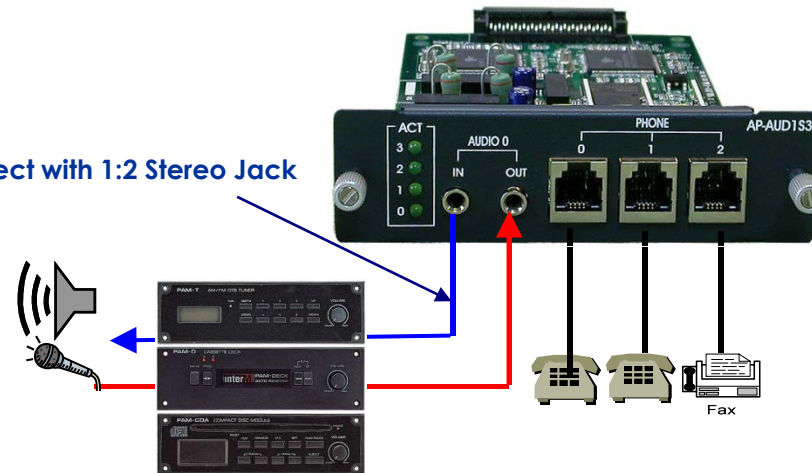



# AP3120 System Configuration

## AP-AUD1S2O1 Module Configuration



**AddPac**

[www.addpac.com](http://www.addpac.com)

# AP3120 System Configuration

## AP-AUD1S2O1 Network Configuration

- Remote Access Broadcasting
  - AP-AUD1S2O1 Module based AP3120
  - Via Analog Phone and Cellular Phone
  - Access Control with IVR Function
  - Cellular Phone → FXO Port → Audio Streaming
  - Available Direct Connect to Terminal (AP1601...)
  - Support Broadcasting and VoIP Services Concurrently

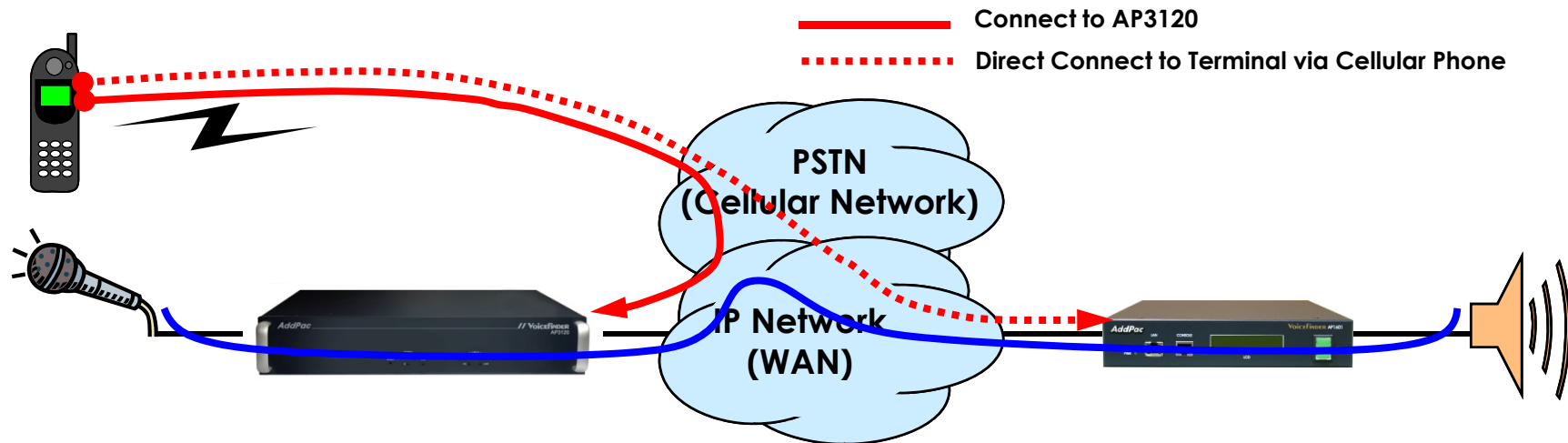

# AP3120 IP Audio Broadcasting System Network

## AP-AUD1S2O1 based Network

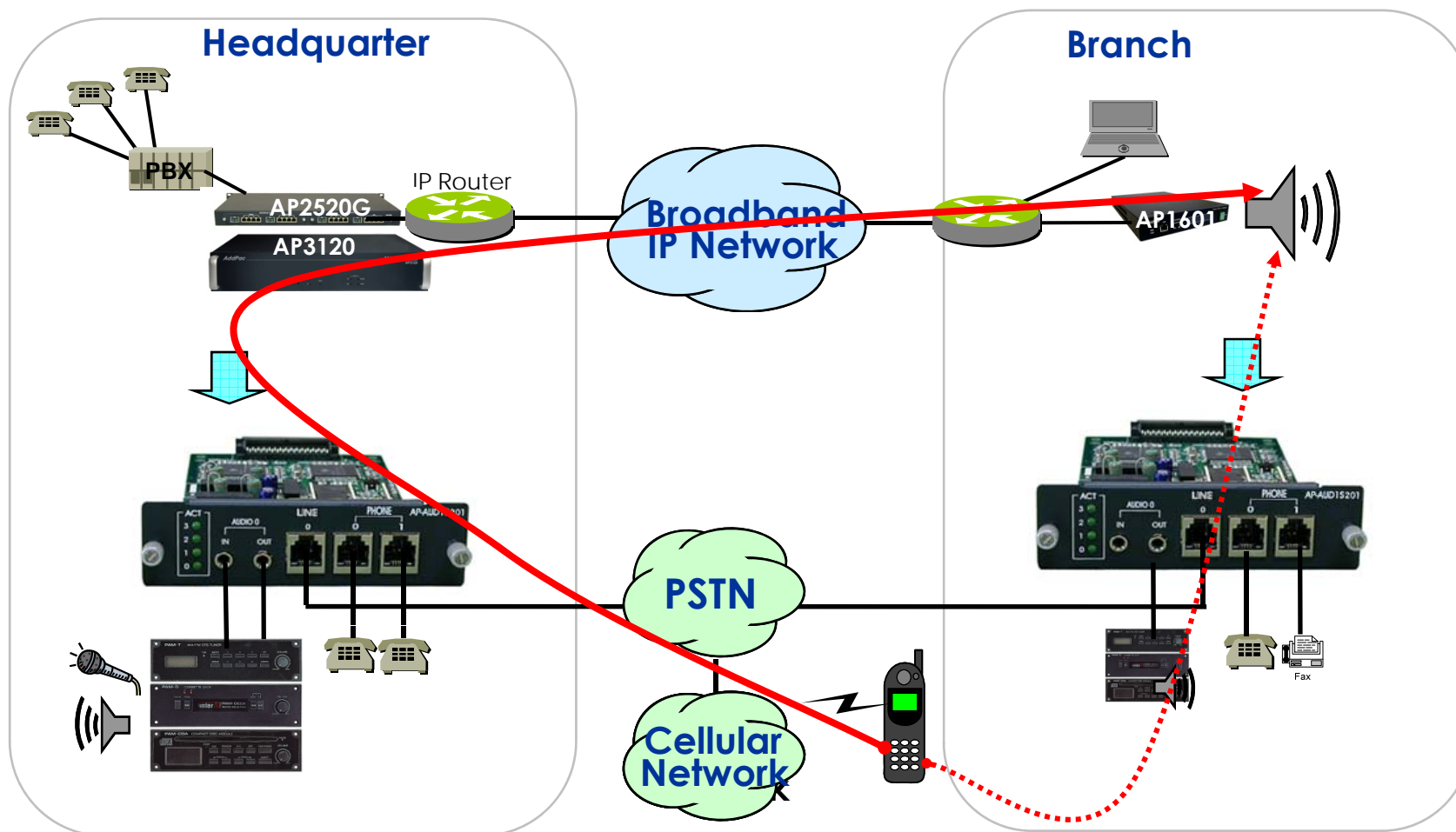

# The Vision of Next Generation Audio Broadcasting

## AP3120 Management Scheme



# AP3120 Management Scheme

## Broadcasting Management System (BMS)

- **AP-BMS**

- MS Windows Graphical User Interface (GUI) based Audio Broadcasting Management
- Service Group Configuration
- Scheduled Broadcasting
- Status Monitoring
- Report Service
- Embedded Media file Manager

- **Requirements Hardware Platform**

- Over 1GHz Intel Pentium 4 Machine
- Over 1GB Main Memory
- Over 40GB Hard Disk Memory
- Microsoft Windows Advanced Server or Windows 2000 Server or Windows XP Professional

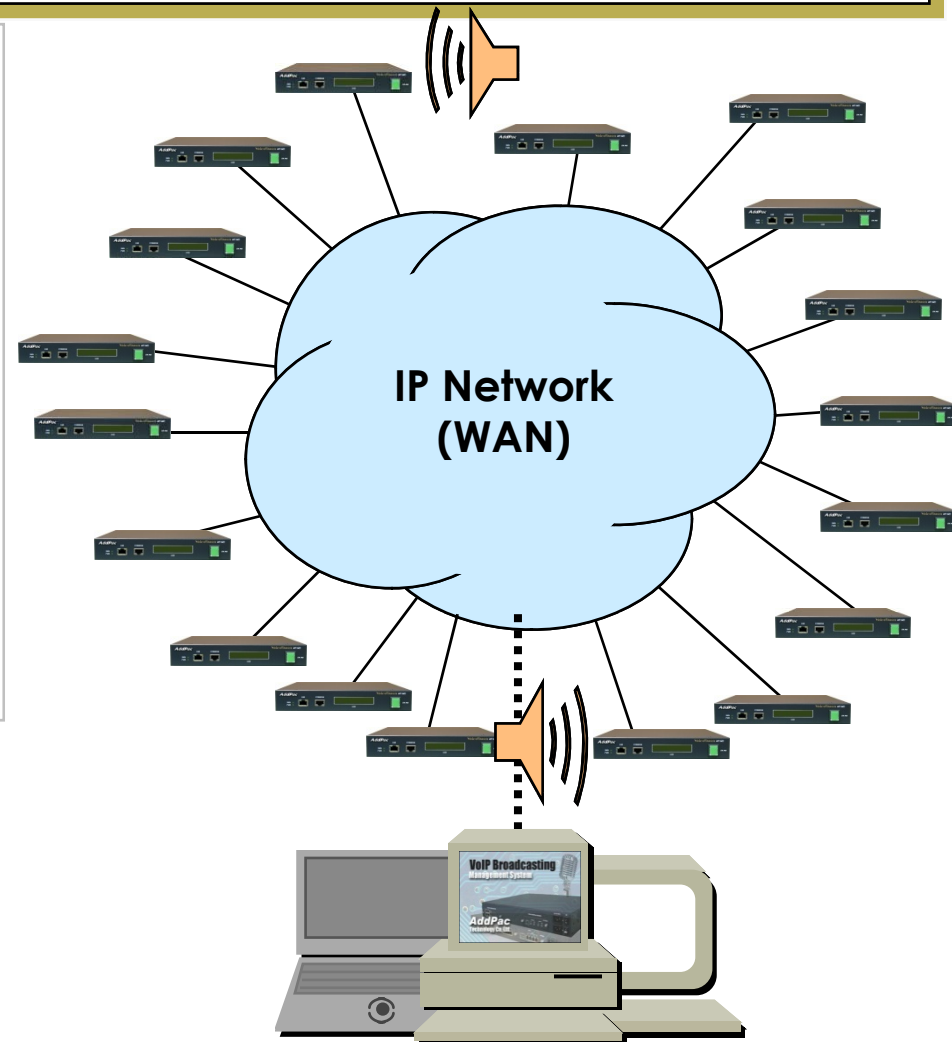

**AddPac**

[www.addpac.com](http://www.addpac.com)

# AP3120 Management Scheme

## Broadcasting Management System (2)

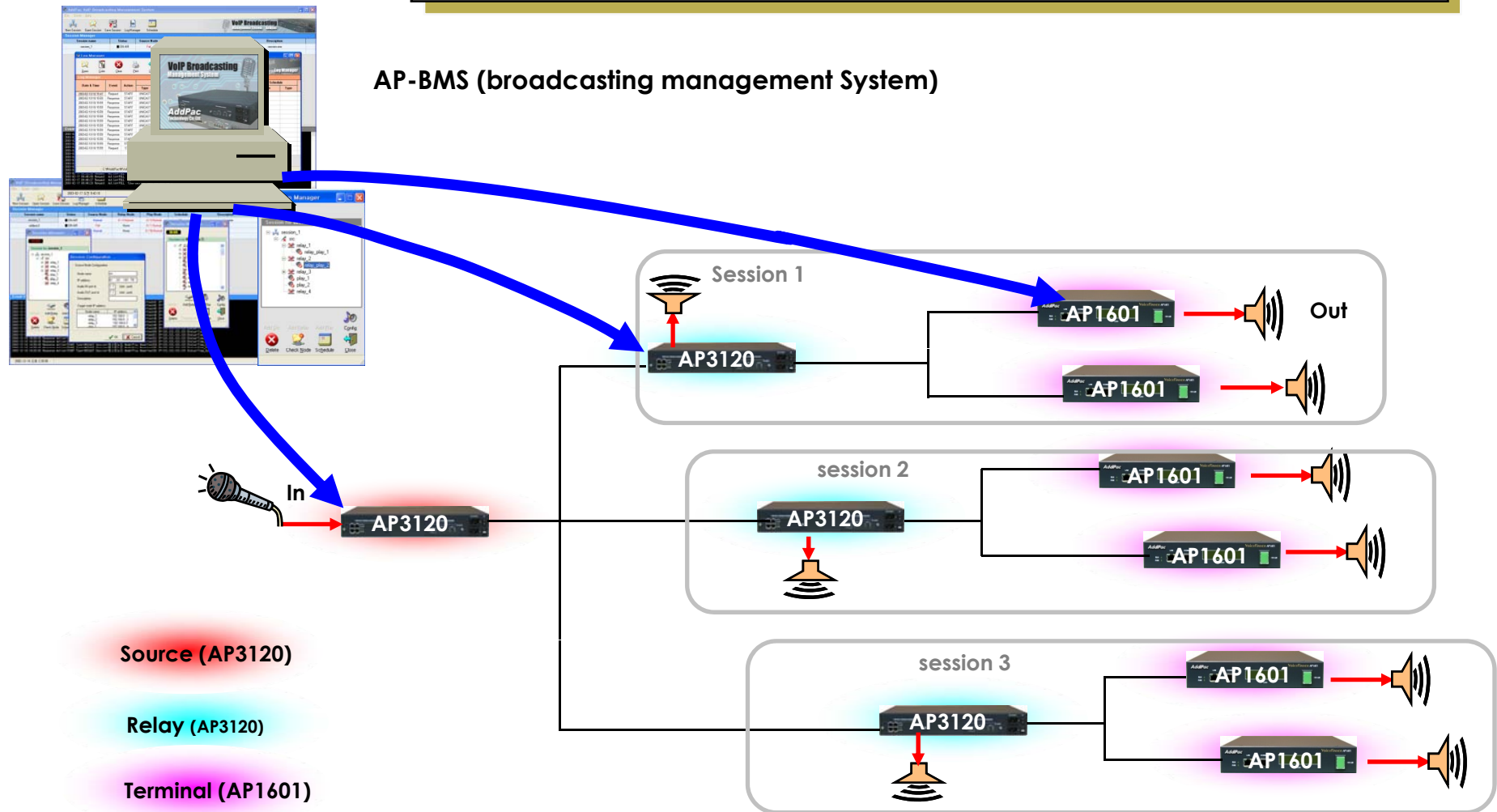

# AP3120 Management Scheme

## Broadcasting Management System (3)

- **AP-BMS, GUI Management Software**
  - Service Group Configuration
  - Scheduled Broadcasting
  - Status Monitoring
  - Report Service
  - Embedded Media File Manager



Main Interface

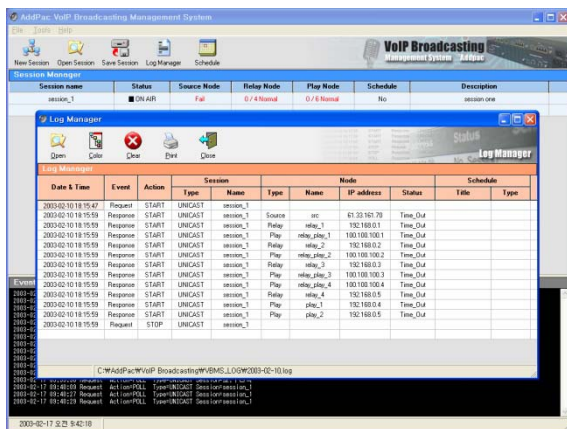

Report Manager

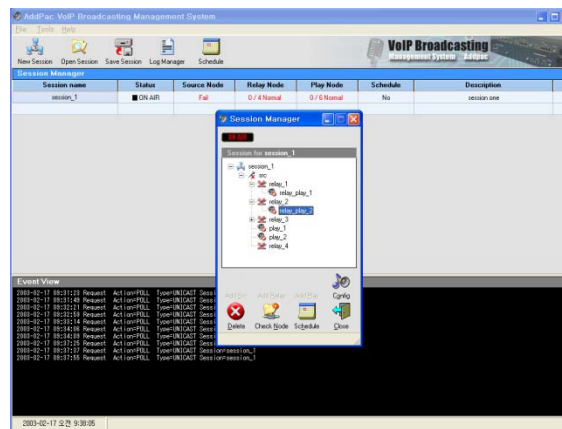

Service Group Configuration

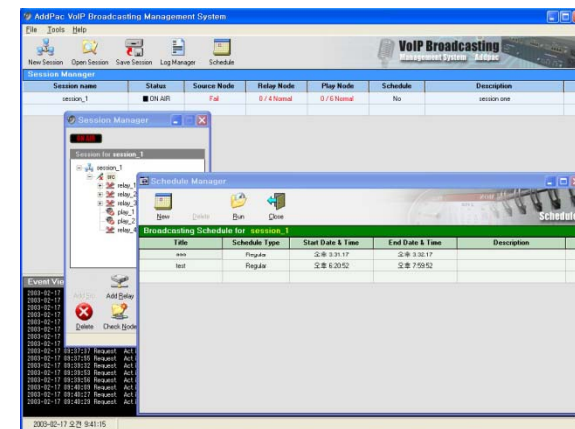

Scheduled Broadcasting

**AddPac**

www.addpac.com

# The Vision of Next Generation Audio Broadcasting

## Network Configuration & Case Study





# Network Configuration & Case Study

## VoIP, Data and IP Broadcasting Network

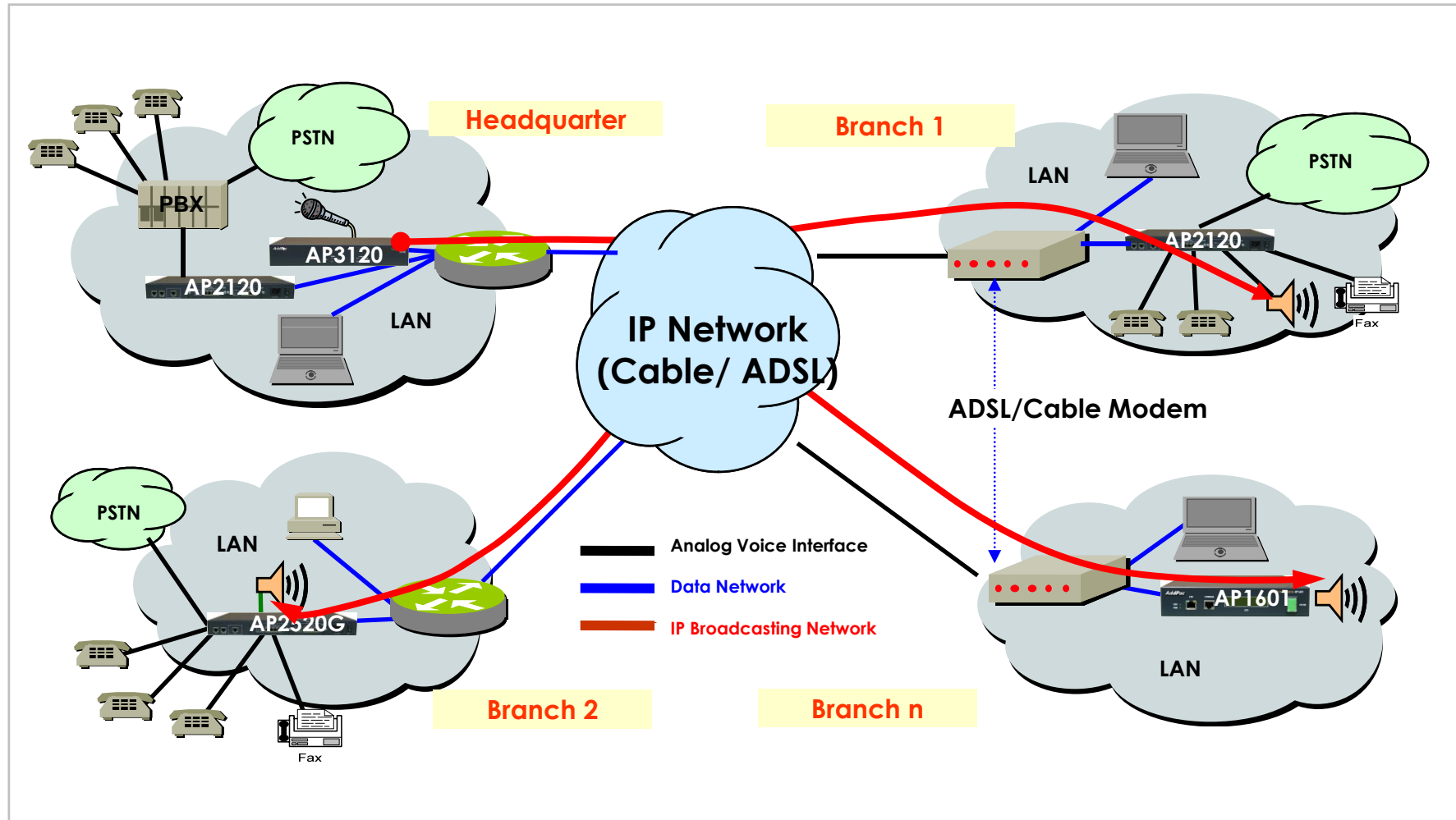

# Network Configuration & Case Study

## Remote Access Broadcasting Network

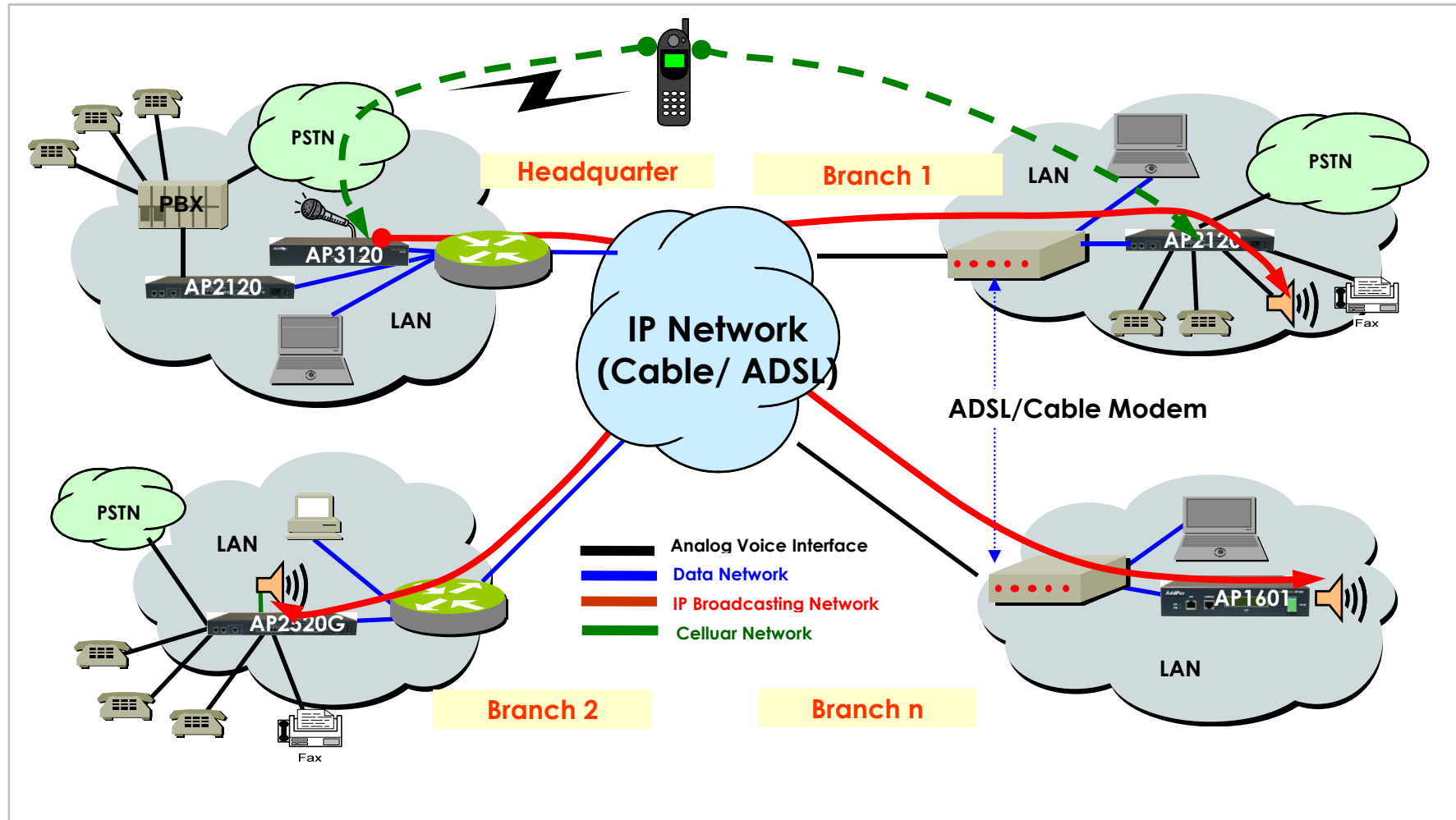

# Network Configuration & Case Study

## Comprehensive Services

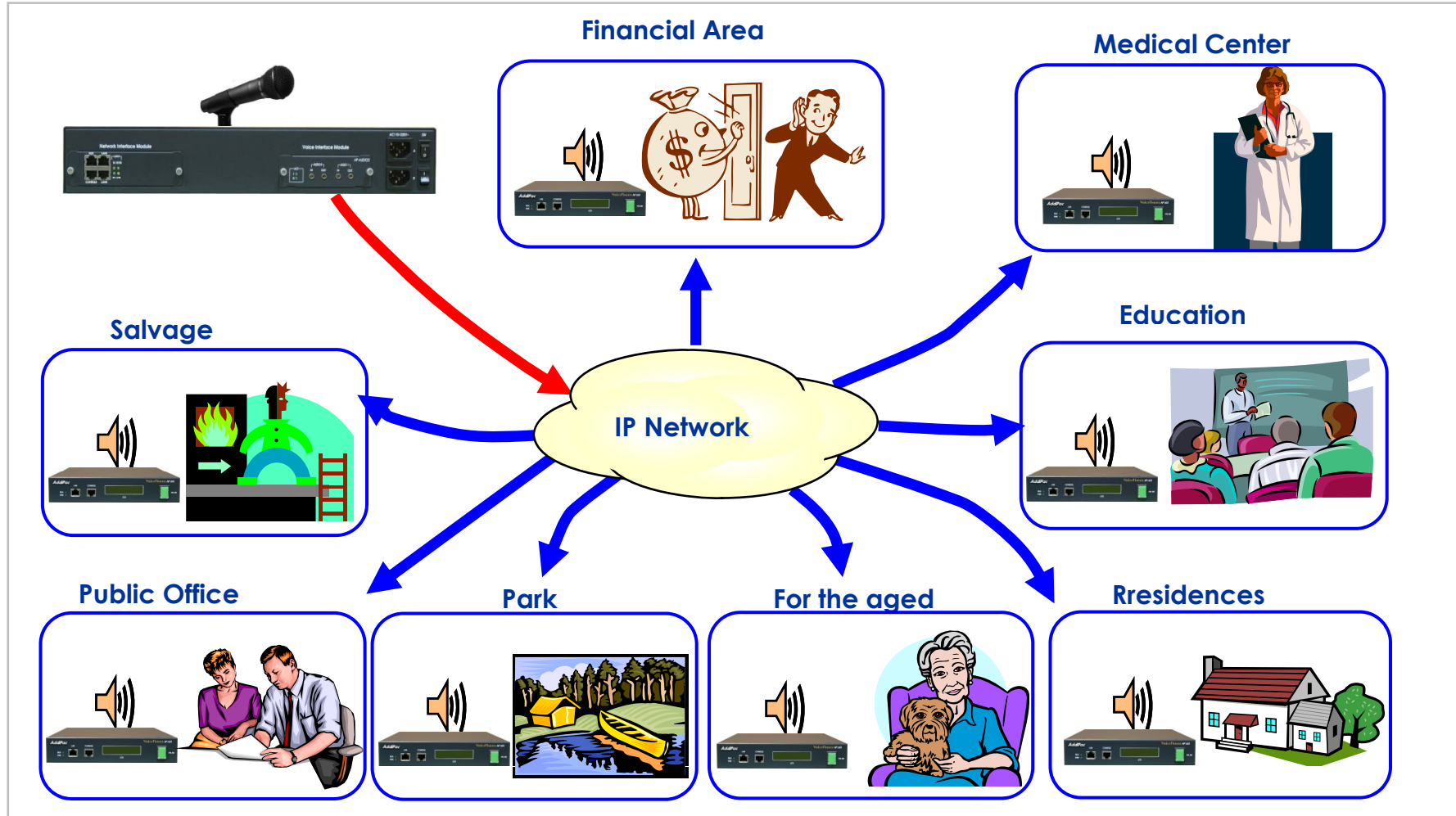

# The Vision of Next Generation Audio Broadcasting

## Appendix



# Appendix

## AP3120 Hardware Specification

AP3120 Broadcasting Server	Basic Specifications
CPU	High Performance 64Bit RISC Microprocessor
Audio Interface	AP-Audio2, AP-AUD1S3, AP-AUD1S2O1, AP-MP3
Voice Interface	3-Ports or 2-Ports FXS((AP-AUD1S3/AUD1S3), 1-Ports FXO(AUD1S2O1) Interface
Ethernet Interface	1-Ports 10/100Mbps Ethernet Interface(RJ-45) 1-Ports 10Mbps Ethernet Interface(RJ-45)
Console Port	1-Port RS-232C Console Port(RJ-45)
Flash Memory	4MB High-speed Flash Memory, 8MB for IVR
Base Memory	128MB High-speed SDRAM
Boot Memory	512KB Flash Memory
Power Requirement	VAC110~220V, 50/60Hz, 25Watt
Operating Temperature	0°C ~ 50°C (32 °F ~ 122°F)
Storage Temperature	-40°C ~ 85°C (-40°C ~ 185°F)
Relative Humidity	5% ~ 95% (Non-condensing)
Dimensions	65×441×323mm (H x W x D)
Weight (g)	2.7Kg

# Appendix

## AP3120 Ordering and Pricing

- **AP3120 IP Broadcasting Server**

- IP Broadcasting Server Hardware

- High-speed 64bit RISC CPU
    - 2-Ports Fast Ethernet
    - 2-Ports RS-232C Console
    - Including Network Cable Set
    - Built-in APOS Internetworking Software
    - Including 1-Year Hardware Warranty

- AP3120-AUDIO2 2Pair Analog Audio-In/Out

- AP3120-MP3 2Pair Analog Audio-In/Out (High Quality Audio Band)

- AP3120-AUD1S3 1Pair Analog Audio-In/Out , FXS 3-Ports

- AP3120-AUD1S2O1 1Pair Analog Audio-In/Out , FXS 2-Ports, FXO 1-Port

- **Pricing**

- AddPac Technology Regional Sales Managers
  - Authorized Sales and Marketing Representatives
  - Please Contact [www.addpac.com](http://www.addpac.com)

# Appendix

## Services Comparison Table

	IP Broadcasting	Legacy Broadcasting
Network	<b>IP Network including Internet</b>	<b>PSTN</b>
Network Cost	<b>Low</b>	<b>High</b>
Protocol	<b>IP Standard</b>	<b>Private Protocol</b>
Scalability	<b>Unlimited</b>	<b>Limited</b>
Interactive Comm.	<b>Yes</b>	<b>NO</b>
Managing Cost	<b>Low</b>	<b>High</b>
Control Env.	<b>GUI based SW</b>	<b>HW level Control</b>
Remote Control	<b>Yes</b>	<b>No</b>
Easy Use	<b>Yes</b>	<b>No</b>
Audio Level Quality	<b>Yes</b>	<b>NO</b>
Sampling rate	<b>8~22.5KHz</b>	<b>Only 8KHz</b>

# Appendix

## Detail information about IP Broad. Solution

- AP3120 IP Broadcasting Server → [Move to Web](#)
- AP1601 IP Broadcasting Terminal → [Move to Web](#)
  - AP-AUDIO2 Audio Module → [Move to Web](#)
  - AP-MP3 High Quality Audio Band Module → [Move to Web](#)
  - AP-AUD1S3 Audio Module → [Move to Web](#)
  - AP-AUD1S2O1 Audio Module → [Move to Web](#)
  - AP-PSB Power switching Box → [Move to Web](#)
  
- Audio Band IP based Broadcasting Solution → [Move to Web](#)
- Voice Band IP based Broadcasting Solution → [Move to Web](#)



**Thank you !**

[www.addpac.com](http://www.addpac.com)

**[sales@addpac.com](mailto:sales@addpac.com)**

Phone : +82 2 568 3848

Fax : +82 2 568 3847

***AddPac***

[www.addpac.com](http://www.addpac.com)

57