

# Video Modules for Multi-Service Video Codecs



**AddPac**

**AddPac Technology**

2011, Sales and Marketing

# Contents

- AddPac D1 Network DVR Service Diagram
- AP-NC1200, AP-NC1500, AP-NC3800 Multi-Service Video Codec Platform
- Video Modules for AP-NC1200, AP-NC1500, AP-NC3800
  - AV1200N One(1) Channel D1 Video Encoder Module
  - AV1500N Two(2) Channel D1 Video Decoder Module
  - AA1000N AMP. Built-in Audio Broadcasting Module
  - AS1000N Analog Subtitle Generator Module (NTSC, PAL)



# D1 Network DVR Service Diagram

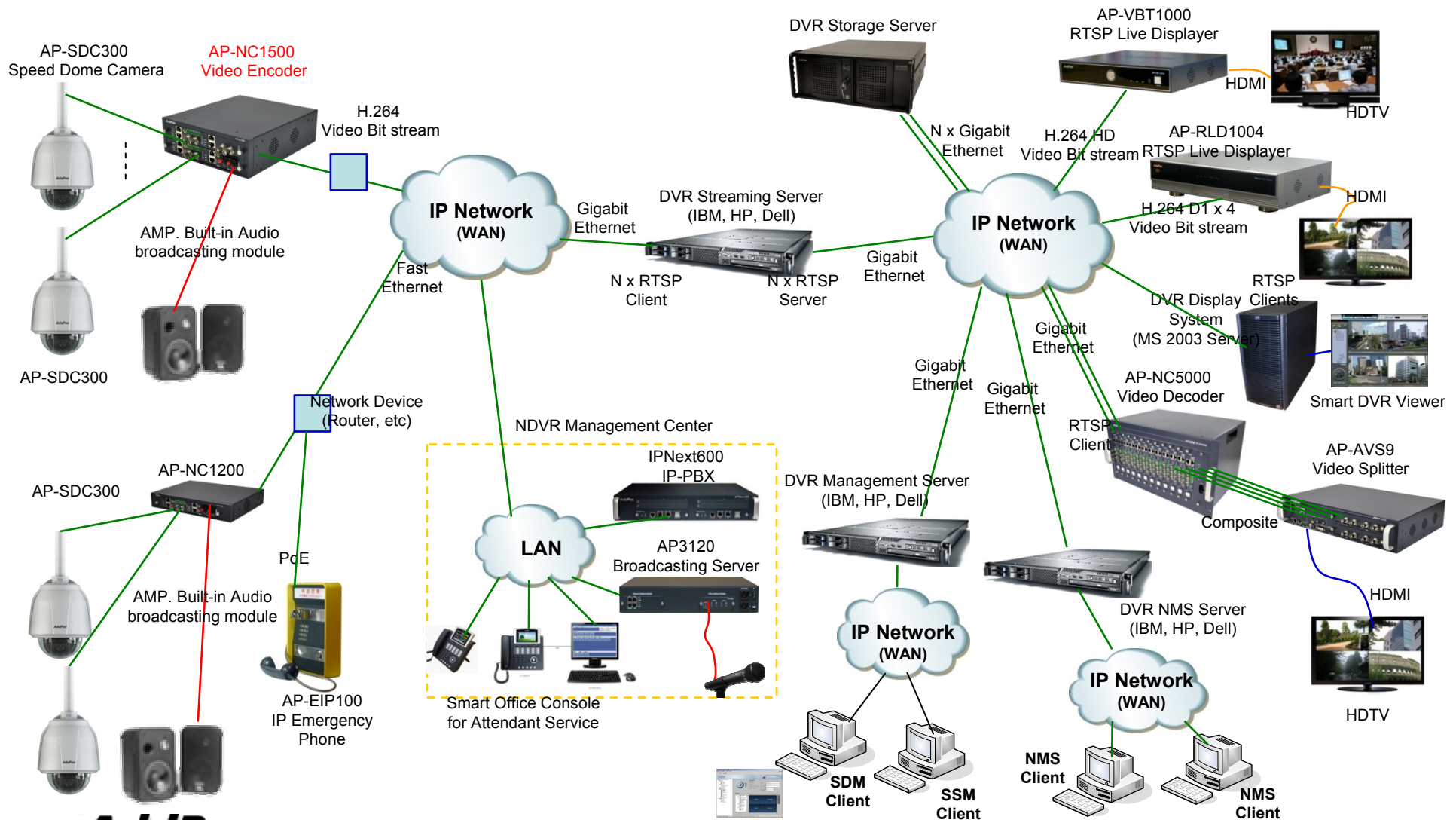



**AddPac**

[www.addpac.com](http://www.addpac.com)



# AP-NC1200, AP-NC1500, AP-NC3800 Platform

# AP-NC1200, AP-NC1500, AP-NC3800 Platform

	AP-NC1200	AP-NC1500	AP-NC3800
Model			
Module Slot	1 Module 2 Card Slot	2 Module 4 Card Slots	12 Module Slots
Power Supply	External DC Power Supply	Internal Power Module (AC)	Internal Power Module (AC) Dual Power Supply Module
Power Type	Power Adaptor	Built-In	Module Type



# AP-NC1200 Multi-Service Video Codec

# Multi-Service Video Codec

## AP-NC1200 Video Codec

### Main Features

- IP based Audio/Video Encoding/Decoding Solution
- Various Video Codec Support : H.264
- One(1) Module 2-Card Slot for Video/Audio Codec Modules
- Up to D1 Video Resolution (Optional HD)
- RTSP, TCP/UDP Protocol Support
- IP based Network Surveillance Solution
- High-performance Video, Audio, and Voice Service
- Firmware Upgradeable Architecture
- Video Solution with Outstanding Network Service Capability
- Audio/Video Privacy Protection
- External DC Power Supply Adaptor
- Compact Chassis

# Multi-Service Video Codec

## AP-NC1200 Video Codec

### Hardware Specification

### AP-NC1200 Front Side View



AP-AV1500N Module  
Dual Channel D1 Encoder Module

AP-AA1000N  
AMP Built-in Audio Broadcasting  
Module





# AP-NC1500 Multi-Service Video Codec

# Multi-Service Video Codec

## AP-NC1500 Video Codec

### Main Features

- IP based Audio/Video Encoding/Decoding Solution
- Various Video Codec Support : H.264
- Two(2) Module 4-Card Slot for Video/Audio Codec Modules
- Up to D1 Video Resolution (Optional HD)
- RTSP, TCP/UDP Protocol Support
- IP based Network Surveillance Solution
- High-performance Video, Audio, and Voice Service
- Firmware Upgradeable Architecture
- Video Solution with Outstanding Network Service Capability
- Audio/Video Privacy Protection
- Internal Power Module
- Compact Chassis

# Multi-Service Video Codec

## AP-NC1500 Video Codec

### Hardware Specification

AP-NC1500 Front Side View



AP-AV1500N Module  
Dual Channel D1 Encoder Module

AP-AA1000N  
AMP Built-in Audio Broadcasting  
Module

AP-NC1500 Back Side View





# AP-NC3800 Multi-Service Video Codec

# Multi-Service Video Codec

AP-NC3800 Video Codec

## Main Features

- IP based Audio/Video Encoding/Decoding Solution
- Various Video Codec Support : H.264
- 12 Module Slot for Video/Audio Codec Modules
- Up to D1 Video Resolution (Optional HD)
- RTSP, TCP/UDP Protocol Support
- IP based Network Surveillance Solution
- High-performance Video, Audio, and Voice Service
- Firmware Upgradeable Architecture
- Video Solution with Outstanding Network Service Capability
- Audio/Video Privacy Protection
- Module Type Power Supply
- Dual Redundancy Power Module Slots

# Multi-Service Video Codec

AP-NC3800 Video Codec

High-end  
**DSP**

## Hardware Specification

Front Side View



AV1500N Two(2) Channel D1 Video Module

# Multi-Service Video Codec

AP-NC3800 Video Codec

High-end  
**DSP**

## Hardware Specification

Back Side View

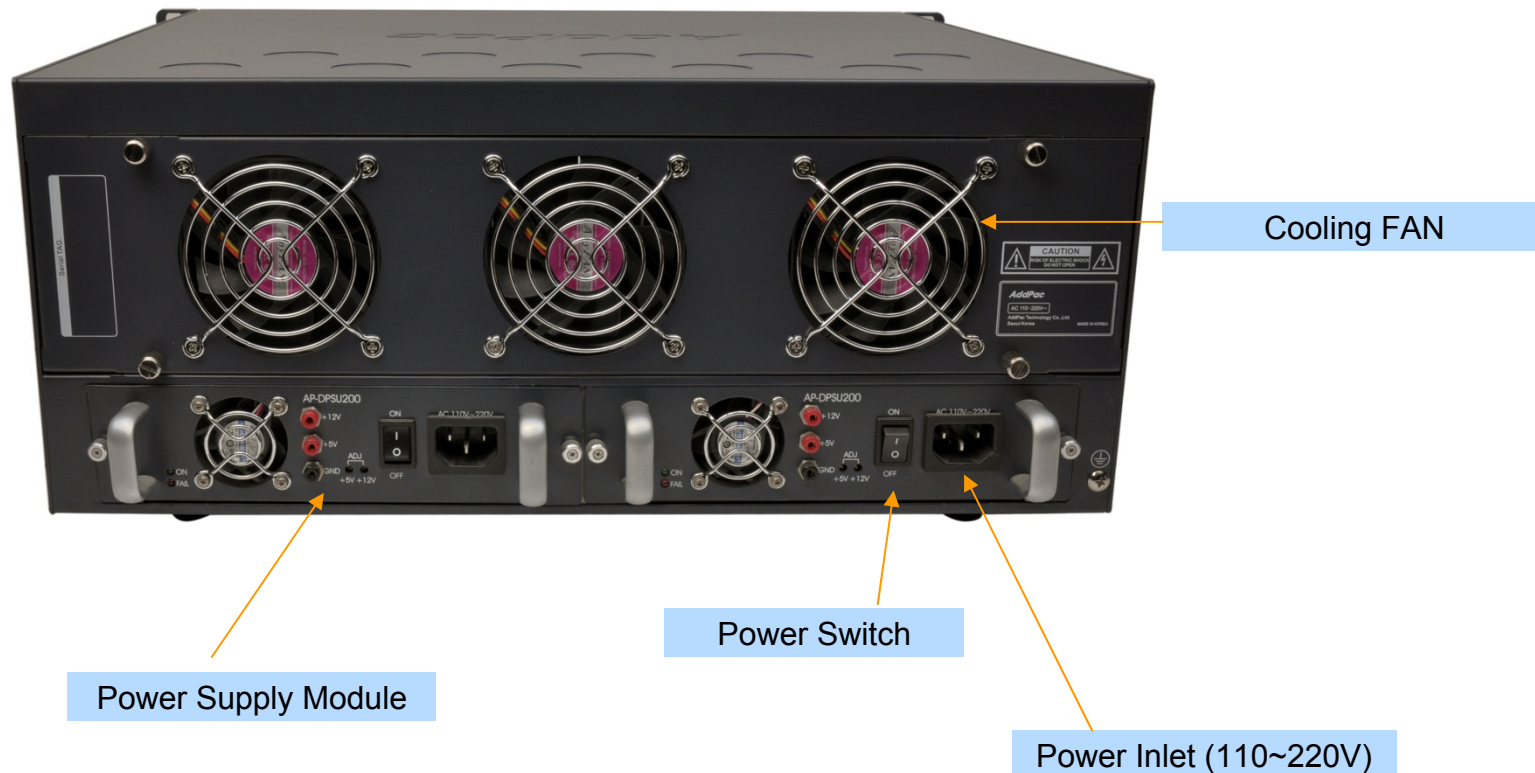







# Video Modules for AP-NC1200, AP-NC1500, AP-NC3800



# Video Modules

High-end  
**DSP**

AV1200N	One(1) Channel D1 Video Encoder Module(H.264 D1, CIF Dual Encoding)	
AV1500N	Two(2) Channel D1 Video Encoder Module(H.264 D1, CIF Dual Encoding)	
AA1000N	AMP built-in Audio Broadcasting Module (G.711, G.726, etc)	
AS1000N	Analog Subtitle Generator Module (VIN, VOUT)	



# AV1200N D1 Video Encoder Module(1 Channel)

# AV1200N D1 Video Codec Modules

## Main Features

- IP based Video Encoding Solution
- One(1) Channel Video Encoder Module
- H.264 Video Codec : D1 Module(D1, CIF Dual Encoding)
- RTSP, TCP/UDP Protocol Support
- RTP/RTCP Protocol Support
- One(1) Gigabit Ethernet Interface
- RS232/RS422/RS485 Interface for Camera Control
- Up to D1 Video Resolution, Up to 30 frame/sec, Up to 2Mbps bandwidth
- IP based Network Surveillance Solution
- High-performance Video, Audio, and Voice Service
- Firmware Upgradeable Architecture
- Video Solution with Outstanding Network Service Capability

# AV1200N D1 Video Codec Modules

High-end  
**DSP**

## Hardware Specification

- High-end Video Processor Architecture
- Network Interface
  - One(1) 10/100/1000Mbps Gigabit Ethernet (RJ45)
- Command Line Interface
  - One(1) RS-232C Interface (RJ45)
- Powerful Video Interface
  - Video Input : 1 Channel Video Input (BNC) : NTSC, PAL
- High quality Audio Interface
  - One(1) Audio Stereo Input, Output channel
- Camera Control Interface
  - One(1) RS-232C, RS422, RS485 Interface for External Camera Control
- I/O Interface
  - 2 Alarm Input, 1 Relay Out

# AV1200N D1 Video Codec Modules

High-end  
**DSP**

## Hardware Module Specification

AV1200N D1 Video Encoder Module (H.264)

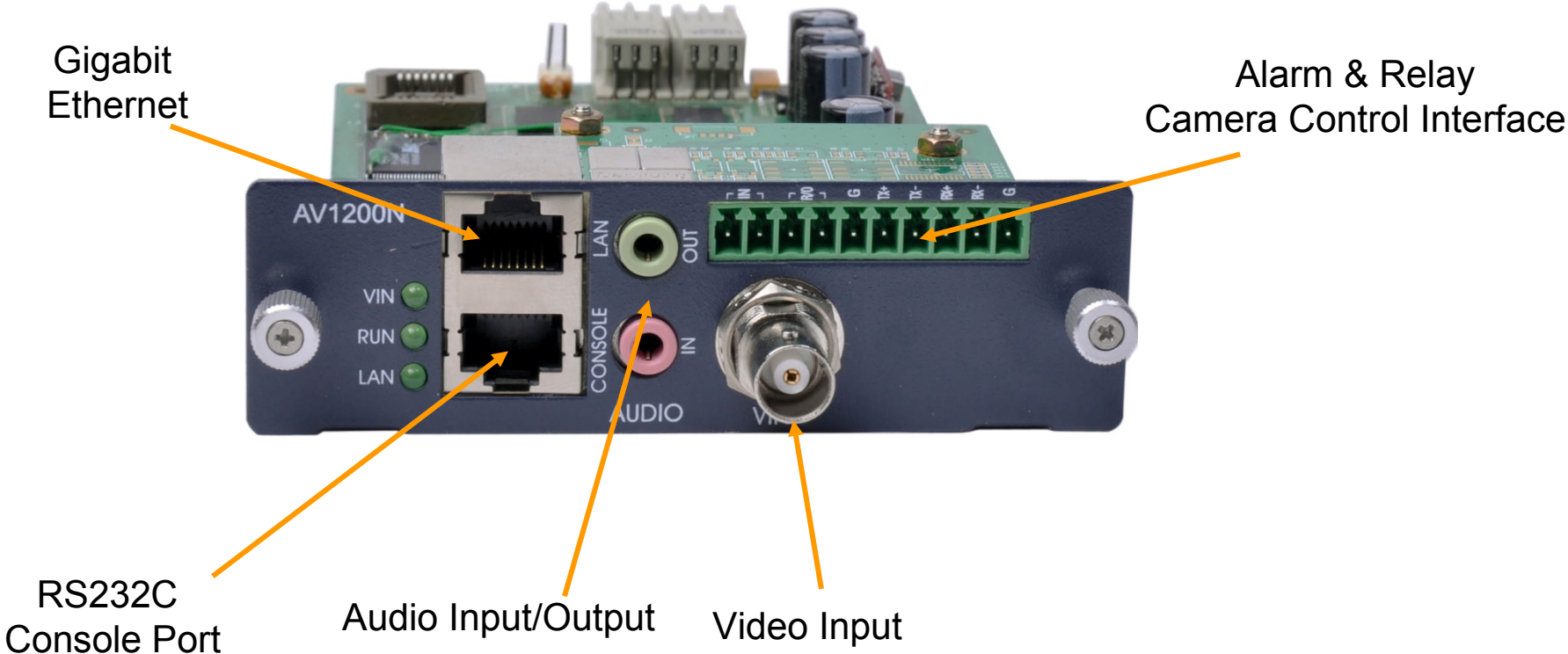



# AV1500N D1 Video Encoder Module(2 Channel)

# AV1500N D1 Video Codec Modules

## Main Features

- IP based Video Encoding Solution
- Two(2) Channel Video Encoder Module
- H.264 Video Codec : D1 Module(D1, CIF Dual Encoding)
- RTSP, TCP/UDP Protocol Support
- RTP/RTCP Protocol Support
- One(1) Gigabit Ethernet Interface
- RS232/RS422/RS485 Interface for Camera Control
- Up to D1 Video Resolution, Up to 30 frame/sec, Up to 2Mbps bandwidth
- IP based Network Surveillance Solution
- High-performance Video, Audio, and Voice Service
- Firmware Upgradeable Architecture
- Video Solution with Outstanding Network Service Capability

# AV1500N D1 Video Codec Modules

High-end  
**DSP**

## Hardware Specification

- High-end Video Processor Architecture
- Network Interface
  - One(1) 10/100/1000Mbps Gigabit Ethernet (RJ45)
- Command Line Interface
  - One(1) RS-232C Interface (RJ45)
- Powerful Video Interface
  - Video Input : 2 Channel Video Input (BNC) : NTSC, PAL
- High quality Audio Interface
  - One(1) Audio Stereo Input, Output channel
- Camera Control Interface
  - One(1) RS-232C, RS422, RS485 Interface for External Camera Control
- I/O Interface
  - 2 Alarm Input, 1 Relay Out



# AV1500N D1 Video Codec Modules

High-end  
DSP

## Hardware Module Specification

AV1500N D1 Video Encoder Module (H.264)

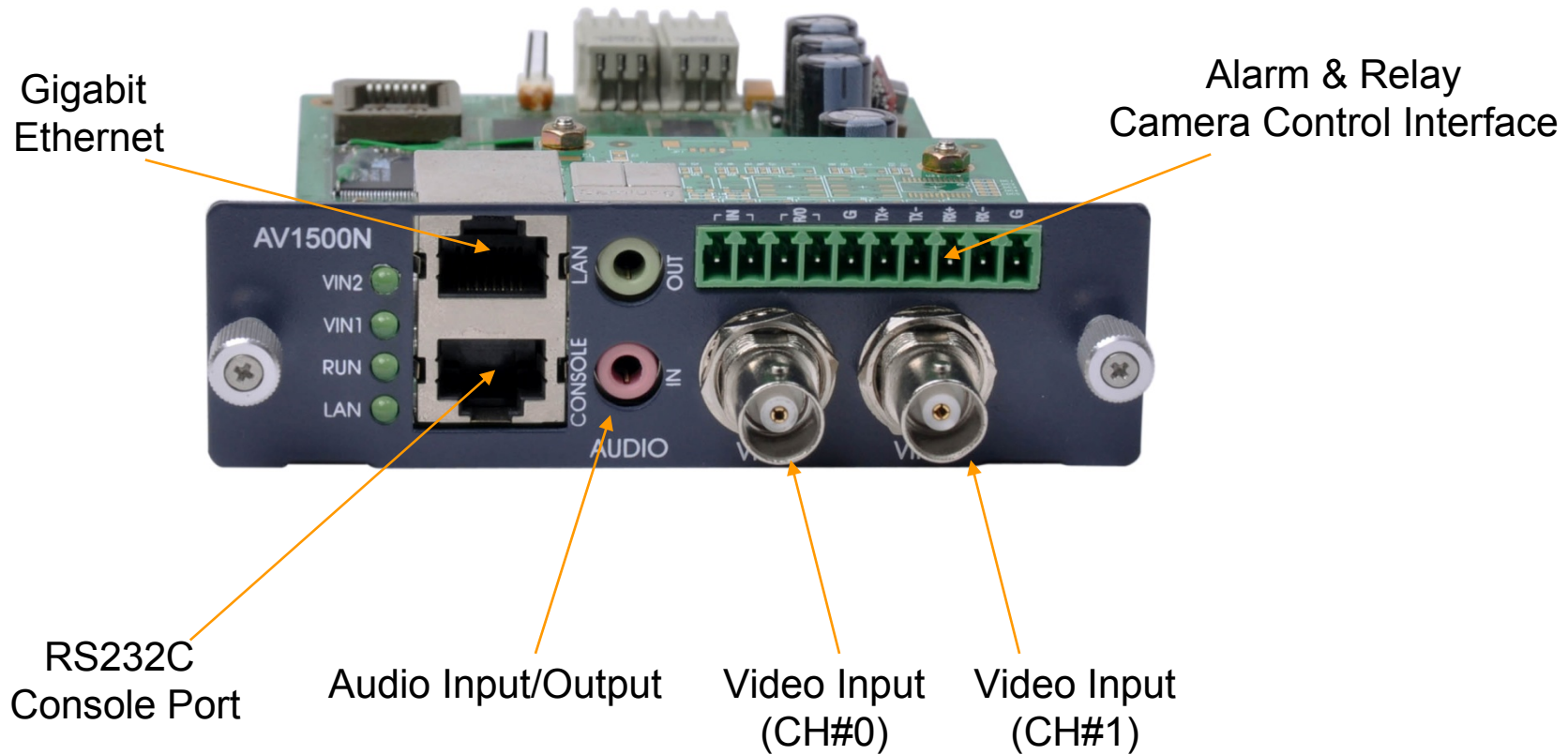



# AA1000N AMP. Built-in Audio Broadcasting Module

# AA1000N AMP. Built-in Audio Modules

## Main Features

- IP based Audio Broadcasting
- AMP.(up to 30W) Built-in Audio Terminal for Speaker Direct Connection
- Audio Input Port Support for Video Codec Interworking
- IP and Analog Audio Port Both Support
- G.711/G.726 Voice Codec Support
- RTP/UDP Protocol Support
- IGMP Protocol Support for Multicasting
- Firmware Upgradeable Architecture
- One(1) Fast Ethernet Interface
- One(1) RS232C Port for CLI

# AA1000N AMP. Built-in Audio Modules

High-end  
**DSP**

## Hardware Specification

- High-end DSP Processor Architecture
- Network Interface
  - One(1) 10/100Mbps Fast Ethernet (RJ45)
- Command Line Interface
  - One(1) RS-232C Interface (RJ45)
- High quality Audio Interface
  - One(1) Audio Stereo Input, Output channel
- AMP. Built-in Speaker Out Interface (Left, Right)

# AA1000N AMP. Built-in Audio Modules

High-end  
**DSP**

## Hardware Specification

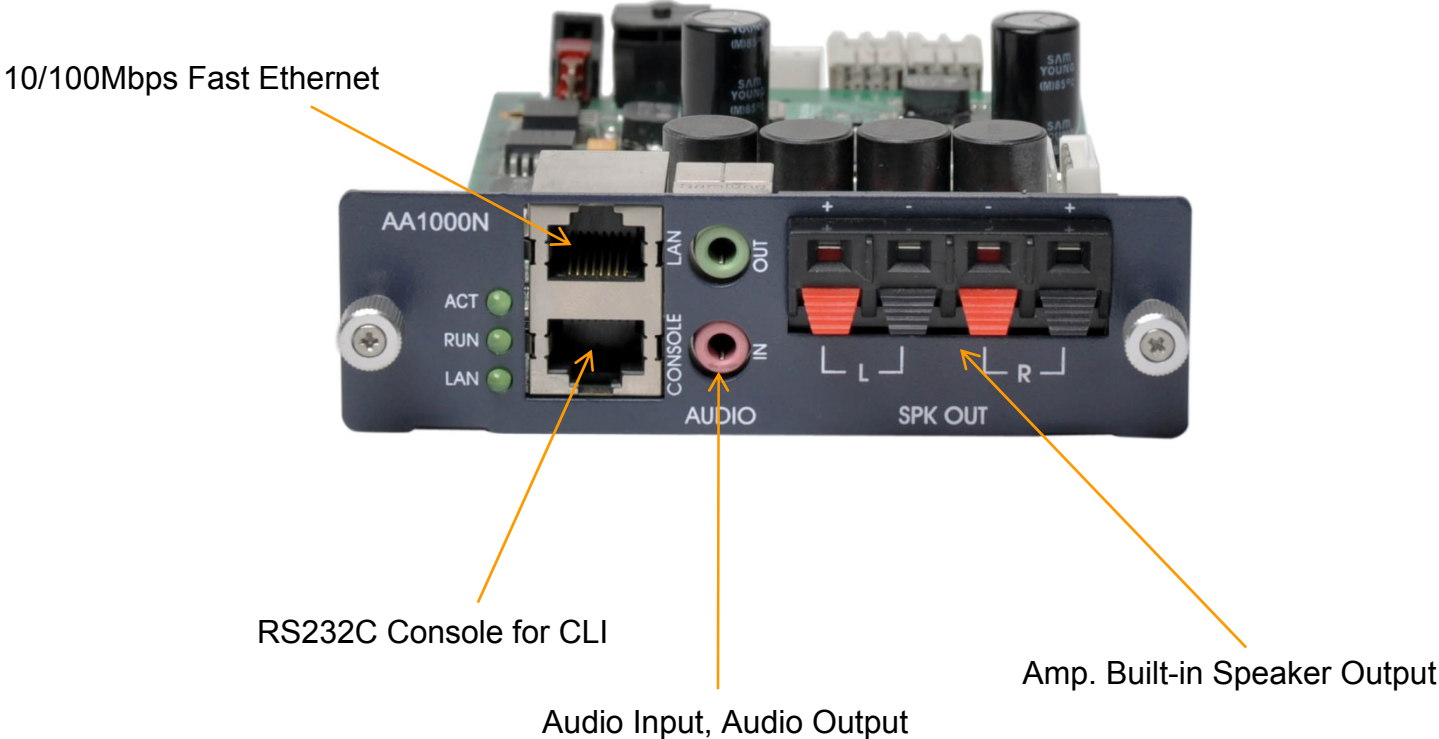



# AS1000N Analog Subtitle Generator Module

# AS1000N Subtitle Generator Modules

High-end  
**DSP**

## Main Features

- Analog Subtitle Generation Service Features
- PC based Subtitle Controller Software
- High-end Video Processor Architecture
- One(1) 10/100/1000Mbps Gigabit Ethernet Interface
- One(1) RS232C Command Line Interface(RJ45)
- IP based Network Surveillance Solution
- High-performance Video, Audio, and Voice Service
- Firmware Upgradeable Architecture
- Video Solution with Outstanding Network Service Capability
- Audio/Video Privacy Protection

# AS1000N Subtitle Generator Modules

High-end  
**DSP**

## Hardware Specification

- High-end Video Processor Architecture
- Network Interface
  - One(1) 10/100/1000Mbps Gigabit Ethernet (RJ45)
- Command Line Interface
  - One(1) RS-232C Interface (RJ45)
- Video Interface
  - Video Input : 1 Channel Video Input (Analog CVBS)
  - Video Output : 1 Channel Video Output (Analog CVBS)



# AS1000N Subtitle Generator Modules

High-end  
**DSP**

## AS1000N Subtitle Generator Module Specification

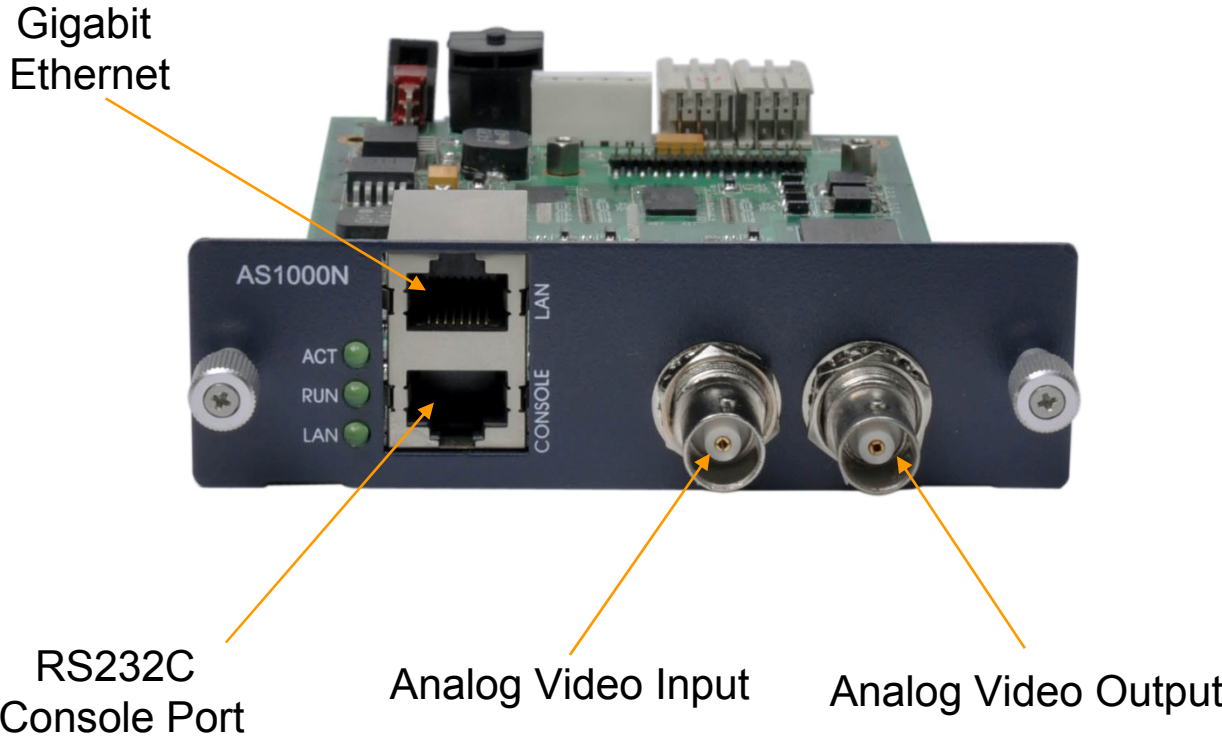



# Thank you!

**AddPac Technology Co., Ltd.**  
Sales and Marketing

Phone +82.2.568.3848 (KOREA)

FAX +82.2.568.3847 (KOREA)

E-mail [sales@addpac.com](mailto:sales@addpac.com)