

Hot-Swap Function for AP6800, AP6500



AddPac

AddPac Technology

2011, Sales and Marketing

www.addpac.com

Contents



- AP6800, AP6500 Hardware Platform
- Hot-Swap VoIP Modules
- System Architecture for Hot-Swap Service
- Example : AP6800 VoIP Module Exchange





AP6800, AP6500 Hardware Platform

AP6800, AP6500 Hardware Platform



Product	AP6500	AP6800
		
Available VoIP Modules	AP-N1-FXS32 AP-N1-FXO32	AP-N1-FXS32 AP-N1-FXO32
Analog Ports	Up to 128 (32 Port Module x 4)	Up to 256 (32 Port Module x 8)
Signaling	SIP, H.323	SIP, H.323
CPU Redundancy (Dual CPU)	Support (Option)	Support (Option)
E&M	N/A	N/A
Module Slot for VoIP Module	4 Slots	8 Slots
LAN Port	2	2
Console	1	1
Dual Power Supply(Optional)	Support	Support



VoIP Modules

AP6500, AP6800 Platform VoIP Modules

High-end
DSP

Target	VoIP Modules	Module Features	Module Picture
AP6500 AP6800	AP-N1-FXS32	32-Port FXS Module	
AP6500 AP6800	AP-N1-FXO32	32-Port FXO Module	

System Architecture for Hot-Swap Function



Hot-Swap Procedure

1. Pull VoIP Module Handler
2. CPU Hot-Swap Register Polling
3. Bit High -> Low
4. Terminate Card Program
5. Eject VoIP Module

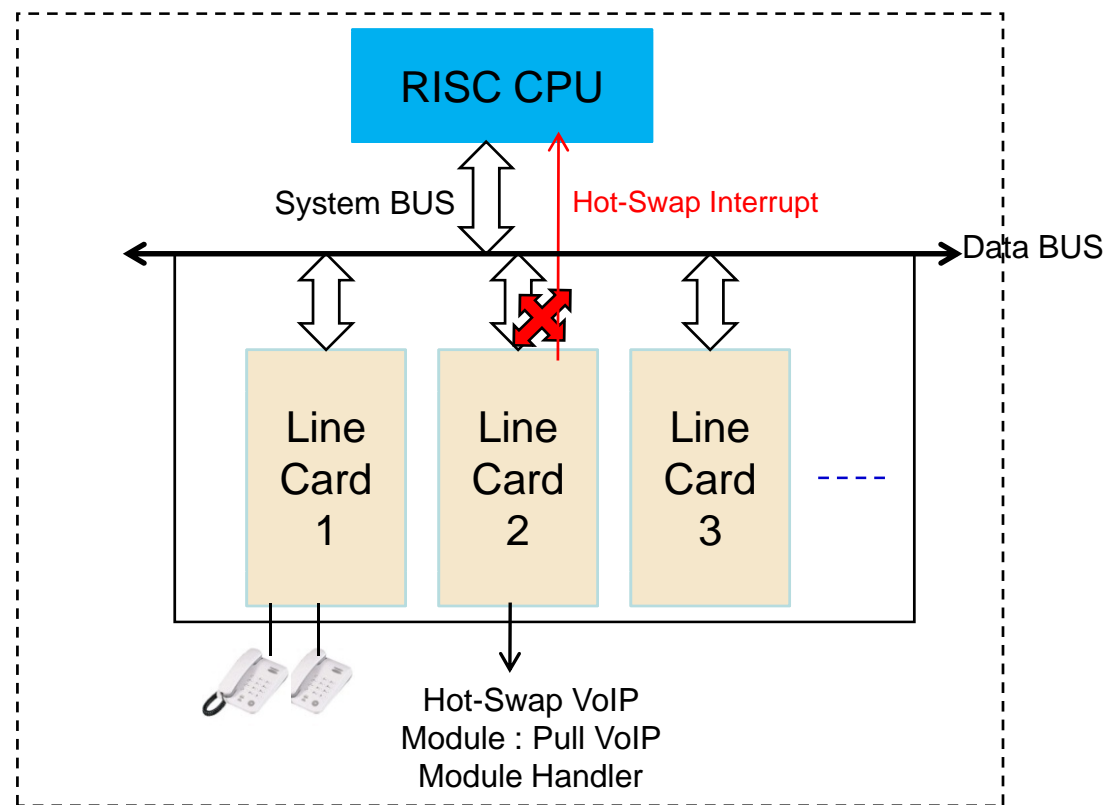
AddPac Large Capacity VoIP Gateways

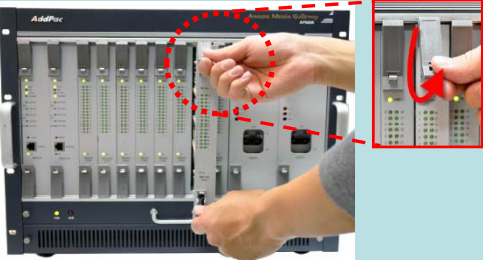

Example : AP6800 VoIP Module Exchange

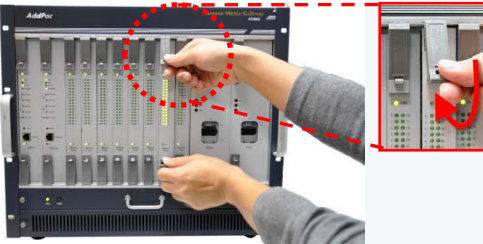
1		<p><Auto Hot-Swap> Pull module handle toward the outside. Module will be removed and Hot-Swap function will be automatically operated.</p>
2		<p><Eject Module> You may remove the module from VoIP Gateway safely.</p>
3		<p><Insert Module> Install by pressing the module handle toward inside. You may install the module in VoIP gateway safely.</p>

VoIP Gateway Series

Thank you!

AddPac Technology Co., Ltd.
Sales and Marketing

Phone +82.2.568.3848 (KOREA)

FAX +82.2.568.3847 (KOREA)

E-mail sales@addpac.com