

IP Phone Series

Call Scenario Features for Call Center
(Barge-In, Whisper, Monitoring)



AddPac

AddPac Technology

Sales and Marketing

www.addpac.com

Contents

- IP Call Center Network Diagram
- IP Phone Call Scenario for Call Center Application
 - Barge-In Call Scenario
 - Whisper Call Scenario
 - Monitoring Call Scenario
- IP Phone Comparison Table
- AddPac IP Phones

IP Call Center Network Diagram (cont.)

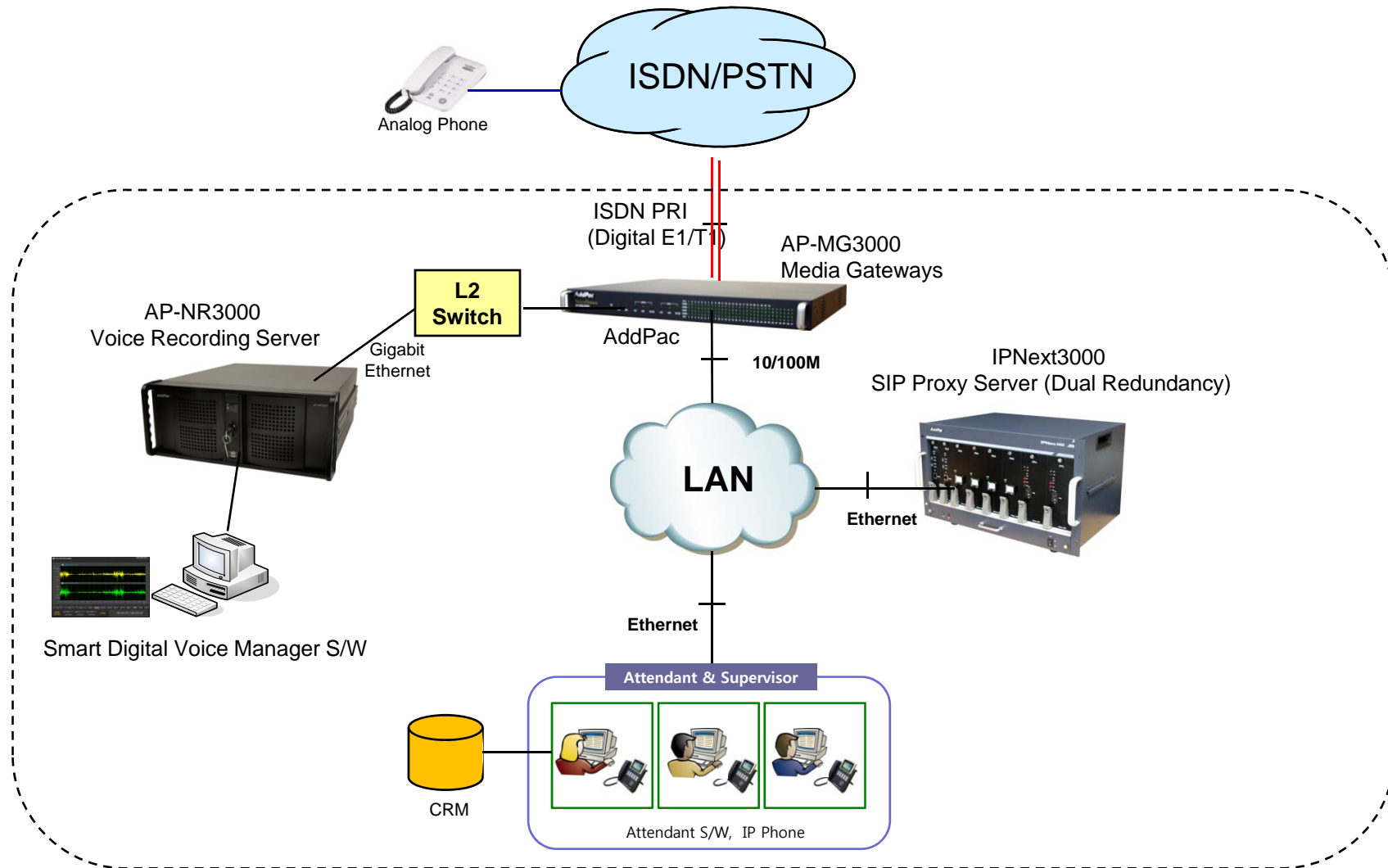

IP Call Center Network Diagram

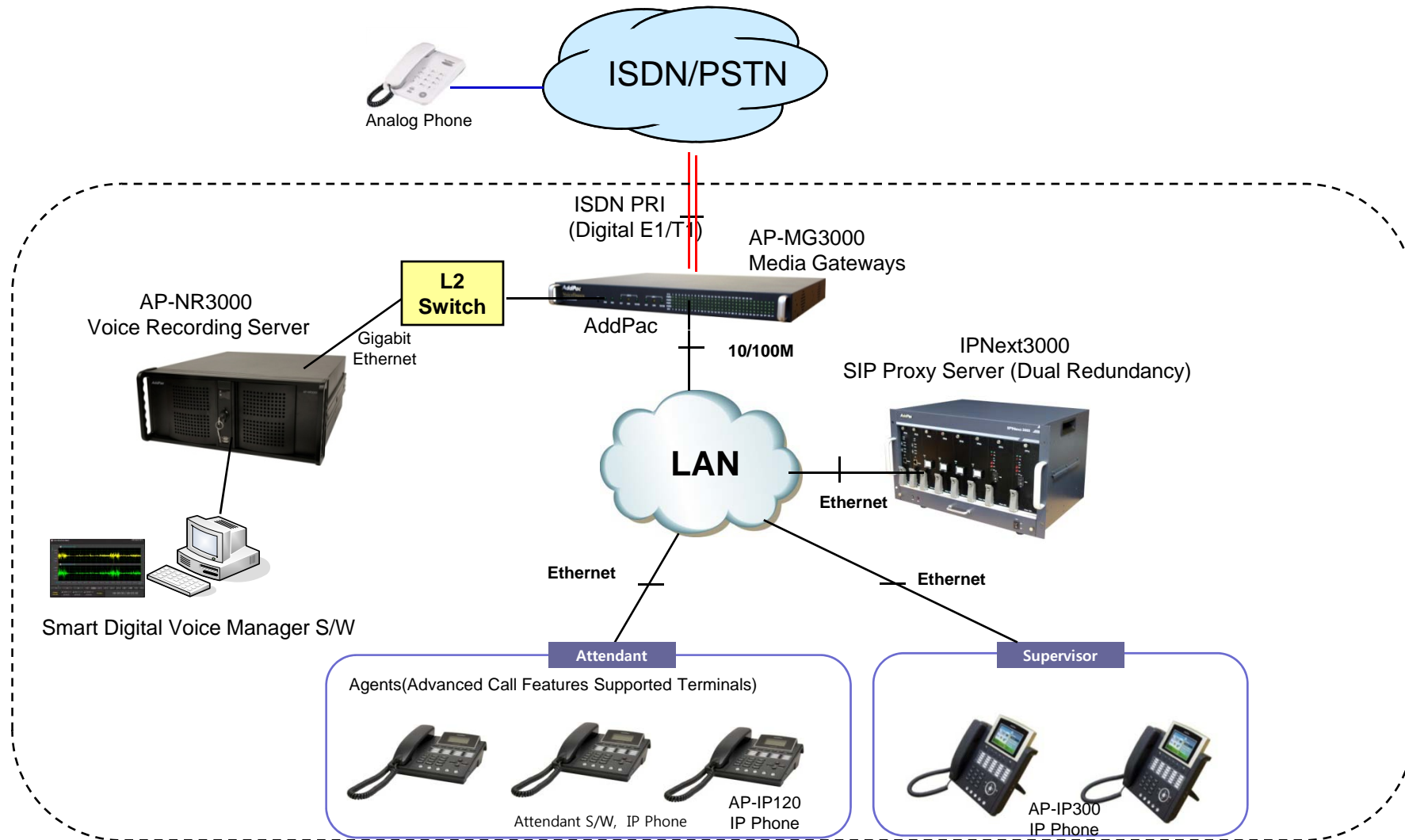

Barge-In Call Scenario Feature

- **Barge-In**

Barge-in allows supervisors to interrupt an agent's call, creating a three-way conference. The supervisor can then interact with both the caller and the agent to help resolve a caller issue.

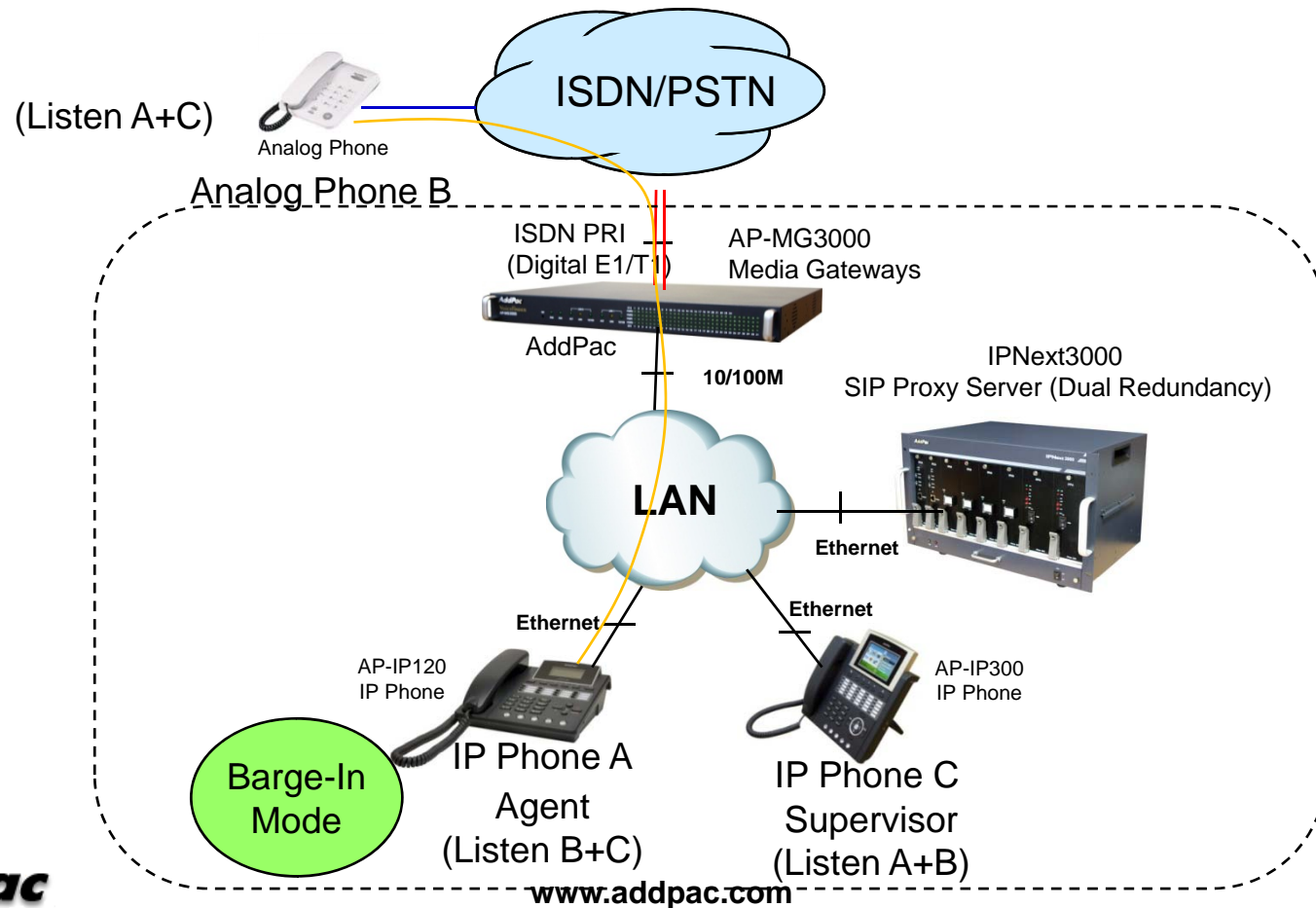

Whisper Call Scenario Feature

- Whisper

Whisper allows supervisors to interrupt an agent's call, creating a three-way conference. The supervisor can then coach the agent to help resolve a caller issue.

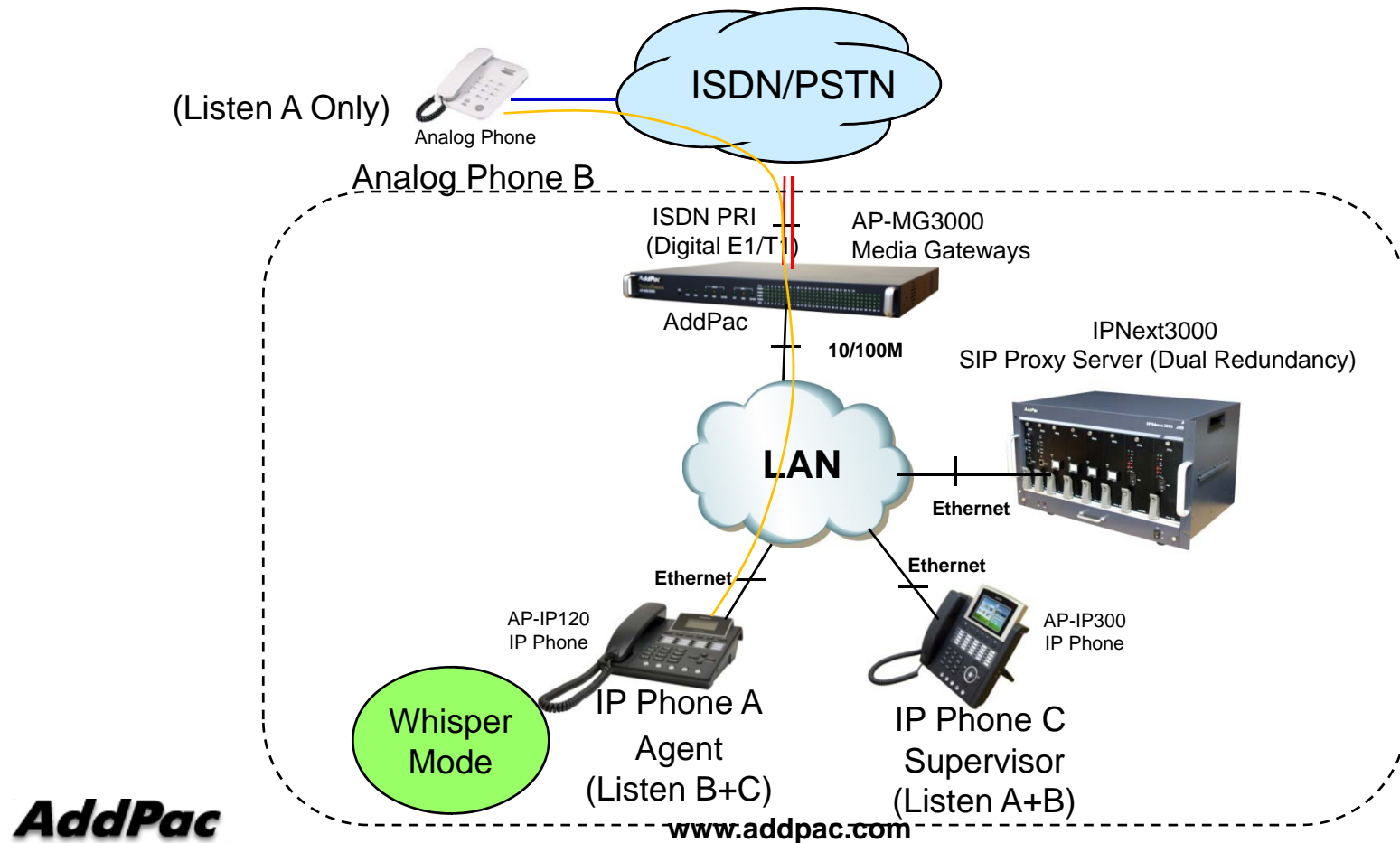

Monitoring Call Scenario Feature

- **Monitoring**

Monitoring provides supervisors with the tools they need to effectively manage their team.

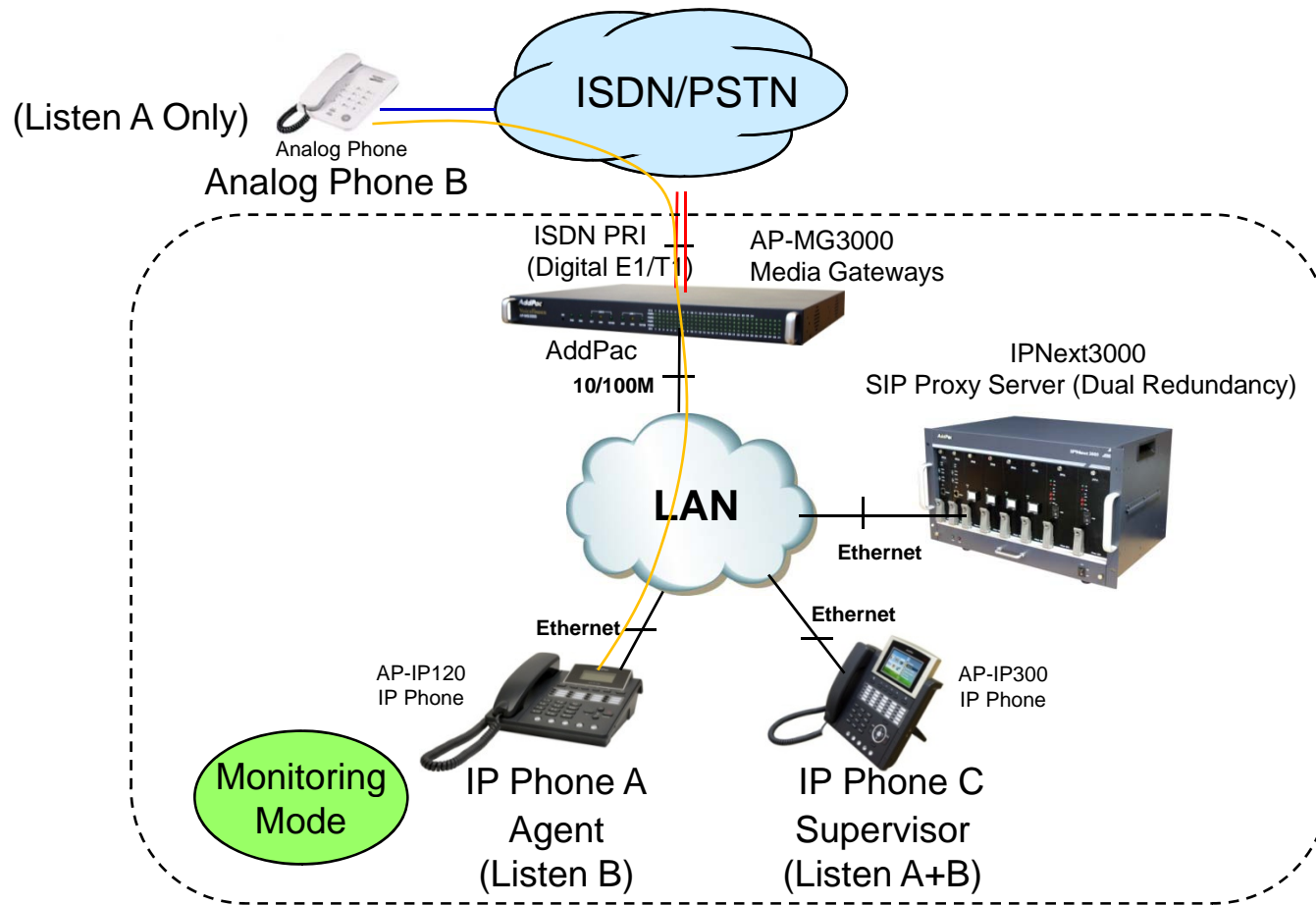

Advanced Call Features Message Flow

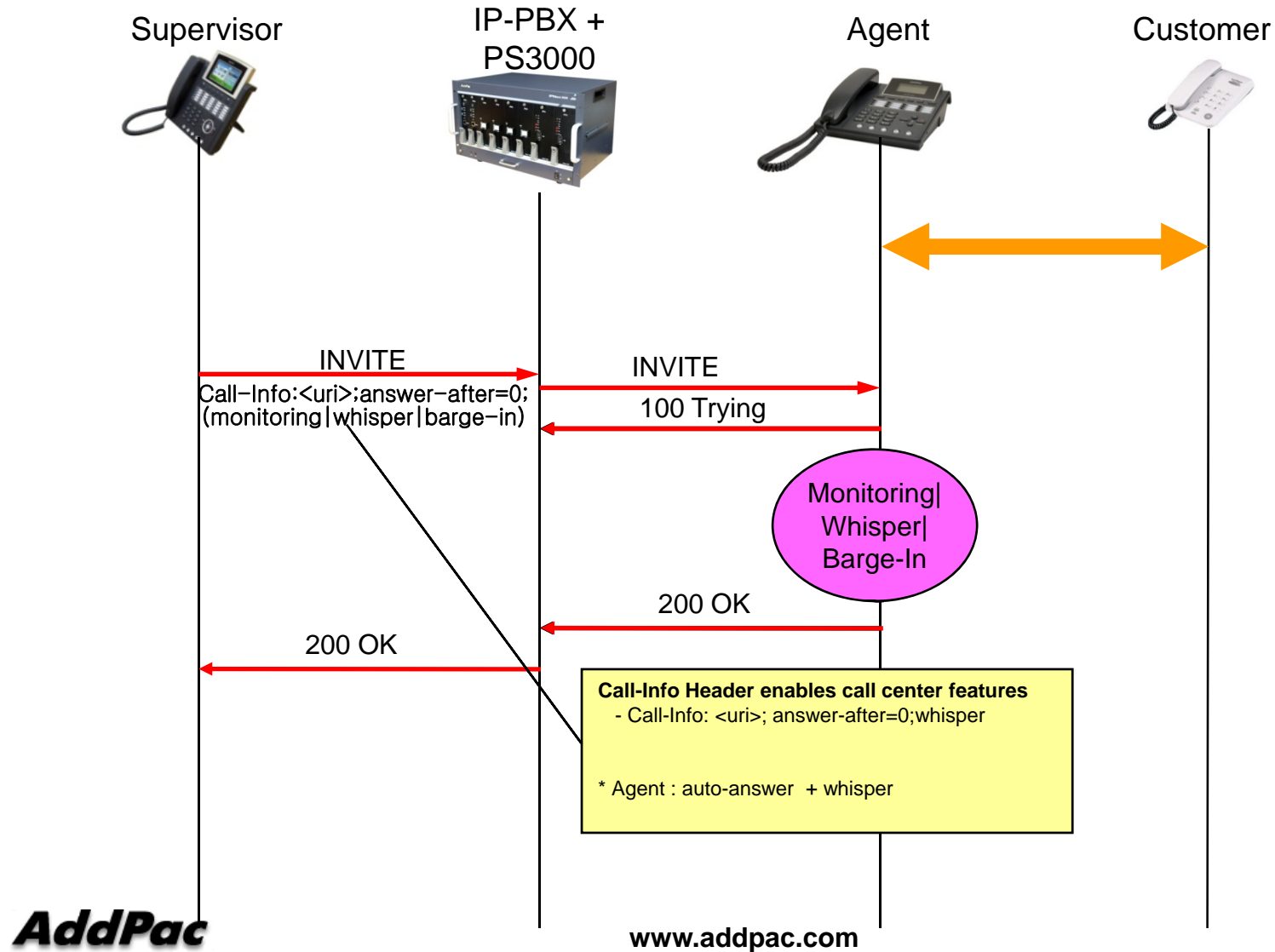

Supervisor configuration

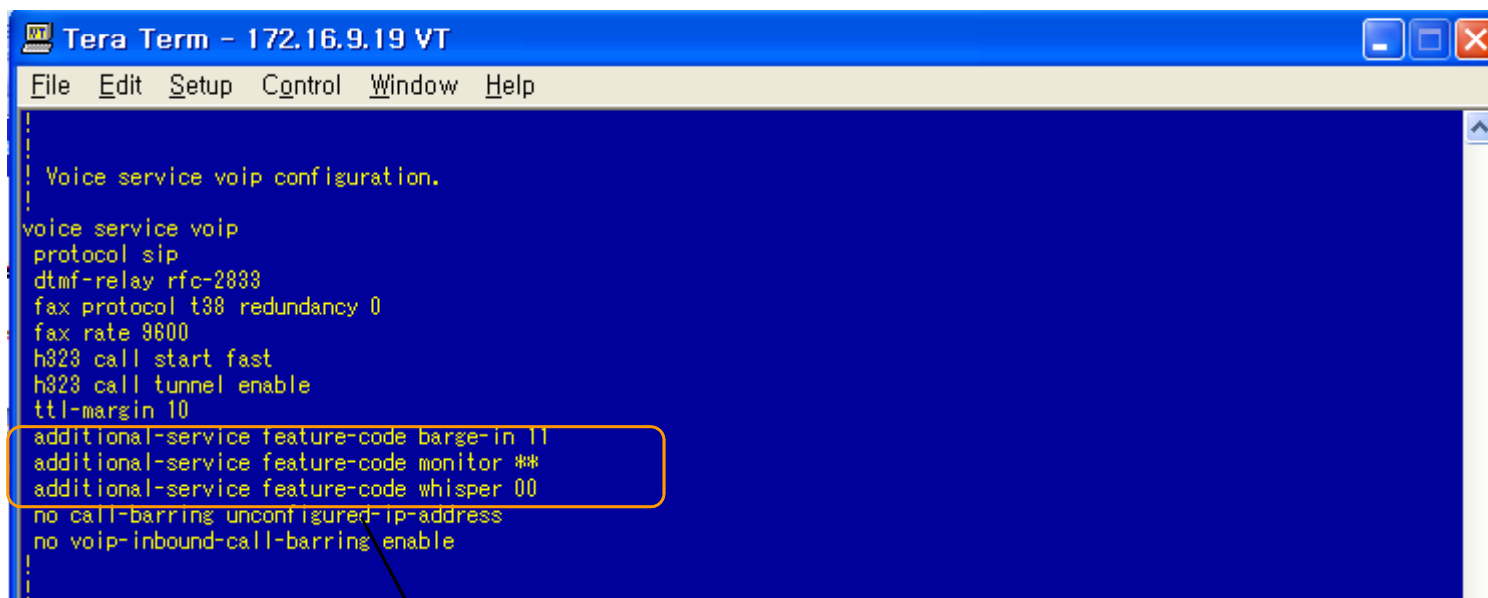

```
Tera Term - 172.16.9.19 VT
File Edit Setup Control Window Help

Voice service voip configuration.
voice service voip
protocol sip
dtmf-relay rfc-2833
fax protocol t38 redundancy 0
fax rate 9600
h323 call start fast
h323 call tunnel enable
ttl-margin 10
additional-service feature-code barge-in 11
additional-service feature-code monitor **
additional-service feature-code whisper 00
no call-barring unconfigured-ip-address
no voip-inbound-call-barring enable
```

Configuration for Call Center features

- Barge-in
- Monitor
- whisper

Feature code + Agent Numbers

Agent configuration

```
Tera Term - COM4 VT
File Edit Setup Control Window Help

Dial Pattern Group configuration.
dialpattern-group 0
pattern 0 400.
```

Configure Allow-Supervisor-Group
- Allow 4000 ~ 4009

```
Tera Term - COM4 VT
File Edit Setup Control Window Help

Pots peer configuration.
dial-peer voice 0 pots
destination-pattern 4008
port 0/0
recording all
barge-in allow-group 0 silence
```

Adapt Supervisor group to Dial-peer
- Configure Mode (Silence | Notify) for privacy

IP Phone Comparison Table

Model	AP-IP300	AP-IP230	AP-IP160	AP-IP120	AP-IP90
Specification					
LCD Size	4.3 Inch Color LCD	5 Inch Color LCD	4 Text Line Graphic LCD	4 Text Line Graphic LCD	4 Text Line Graphic LCD
Touch Screen	N/A	Support	N/A	N/A	N/A
Speed-Dial Keys	25 Key with Presence LED	Touch Screen based 25 Keys	16 Key with Presence LED	12 Key with Presence LED	N/A
Voice Codec	G.711/G.726/G.729/G.723	G.711/G.726/G.729/G.723	G.711/G.726/G.729/G.723	G.711/G.726/G.729/G.723	G.711/G.726/G.729/G.723
Signaling	H.323/SIP	H.323/SIP	H.323/SIP	H.323/SIP	H.323/SIP
3-Party Conversation	Support	Support	Support	Support	Support
LAN Port	2	2	2	2	2
PoE(Optional)	Support	Support	Support	Support	Possible
FXO(Optional)	Support	Support	Support	Support	Support



AddPac IP Phone



AP-IP300 IP Phone

IP Phone

AP-IP300 Premium IP Phone

Main Features

- 4.3 Inch Color LCD Display
- 25 Speed-Dial Keys with User Presence LED
- 4 Soft Key for Call Control
- Various Function Keys
- H.323/SIP Concurrent VoIP Signaling Stack Embedded
- High-performance Voice Codec Support
 - G.711/G.726/G.729/G.723, etc
- Two(2) 10/100Mbps Fast Ethernet (IP Share ,etc)
- High Quality Speaker Phone Features (Acoustic Echo Canceller)
- Powerful Network Protocols (PPPoE, DHCP, Static Routing, etc)
- Firmware Upgradeable Architecture
- VPMS (VoIP Plug&Play Management System) for Large Scale Deployment
- Advanced Voice QoS Mechanism

IP Phone

AP-IP300 Premium IP Phone

RISC
CPU

High-end
DSP

Hardware Specification

- RISC Microprocessor Computing Power
- 4.3 Color LCD
- 25 Speed Dial Keys with User Presence LED
- High-end Programmable DSP Hardware Architecture
- High quality Audio and Voice Interface
 - Stereo Audio Input & Output Connector
- Network Interface
 - Two(2) 10/100Mbps Fast Ethernet
 - One(1) USB 1.0 Interface
- PSTN Interface
 - One(1) FXO(RJ11) interface
- Power Supply
 - *External DC adaptor (5V)*
 - *Power Switch*
 - *PoE (Power over Ethernet)*

IP Phone

AP-IP300 Premium IP Phone

RISC
CPU

High-end
DSP

Hardware Specification



AddPac

www.addpac.com

IP Phone

AP-IP300 Premium IP Phone

RISC
CPU

High-end
DSP

Hardware Specification

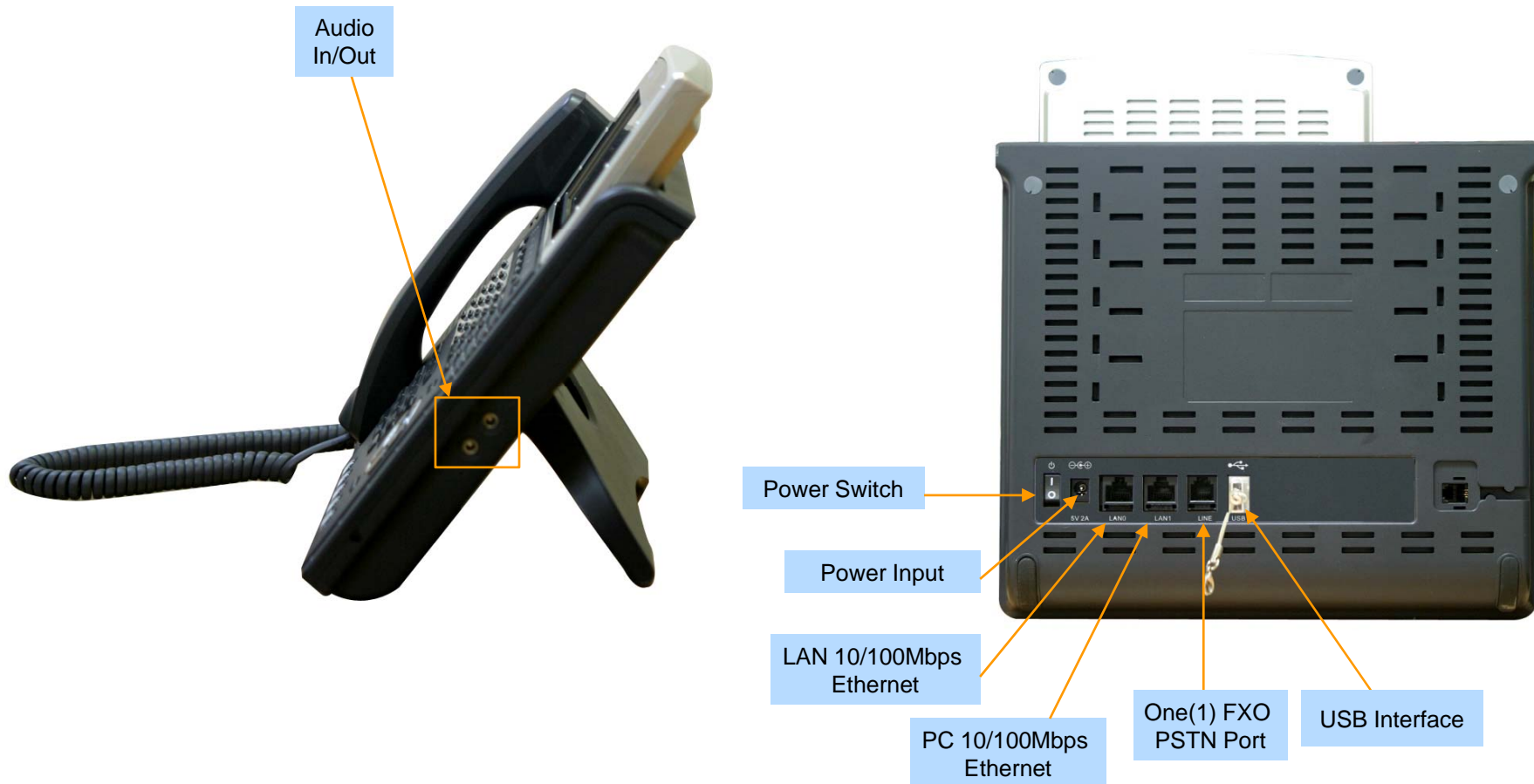



AP-IP230 IP Phone

IP Phone

AP-IP230 Premium IP Phone

Main Features

- 5 Inch Color LCD Display, Touch Screen
- Touch Screen based 25 Speed-Dial Keys
- 4 Soft Key for Call Control
- Various Function Keys
- H.323/SIP Concurrent VoIP Signaling Stack Embedded
- High-performance Voice Codec Support
 - G.711/G.726/G.729/G.723, etc
- Two(2) 10/100Mbps Fast Ethernet (IP Share ,etc)
- High Quality Speaker Phone Features (Acoustic Echo Canceller)
- Powerful Network Protocols (PPPoE, DHCP, Static Routing, etc)
- Firmware Upgradeable Architecture
- VPMS (VoIP Plug&Play Management System) for Large Scale Deployment
- Advanced Voice QoS Mechanism

IP Phone

AP-IP230 Premium IP Phone

RISC
CPU

High-end
DSP

Hardware Specification

- RISC Microprocessor Computing Power
- 5 Inch Color LCD with Touch Screen
- High-end Programmable DSP Hardware Architecture
- High quality Audio and Voice Interface
 - Stereo Audio Input & Output Connector
- Network Interface
 - Two(2) 10/100Mbps Fast Ethernet
 - One(1) USB 1.0 Interface
- PSTN Interface
 - One(1) FXO(RJ11) interface
- Power Supply
 - *External DC adaptor (5V)*
 - *Power Switch*
 - *PoE (Power over Ethernet)*

IP Phone

AP-IP230 Premium IP Phone

Hardware Specification

RISC
CPU

High-end
DSP

5 Inch
LCD with Touch
Screen



IP Phone

AP-IP230 Premium IP Phone

RISC
CPU

High-end
DSP

Hardware Specification

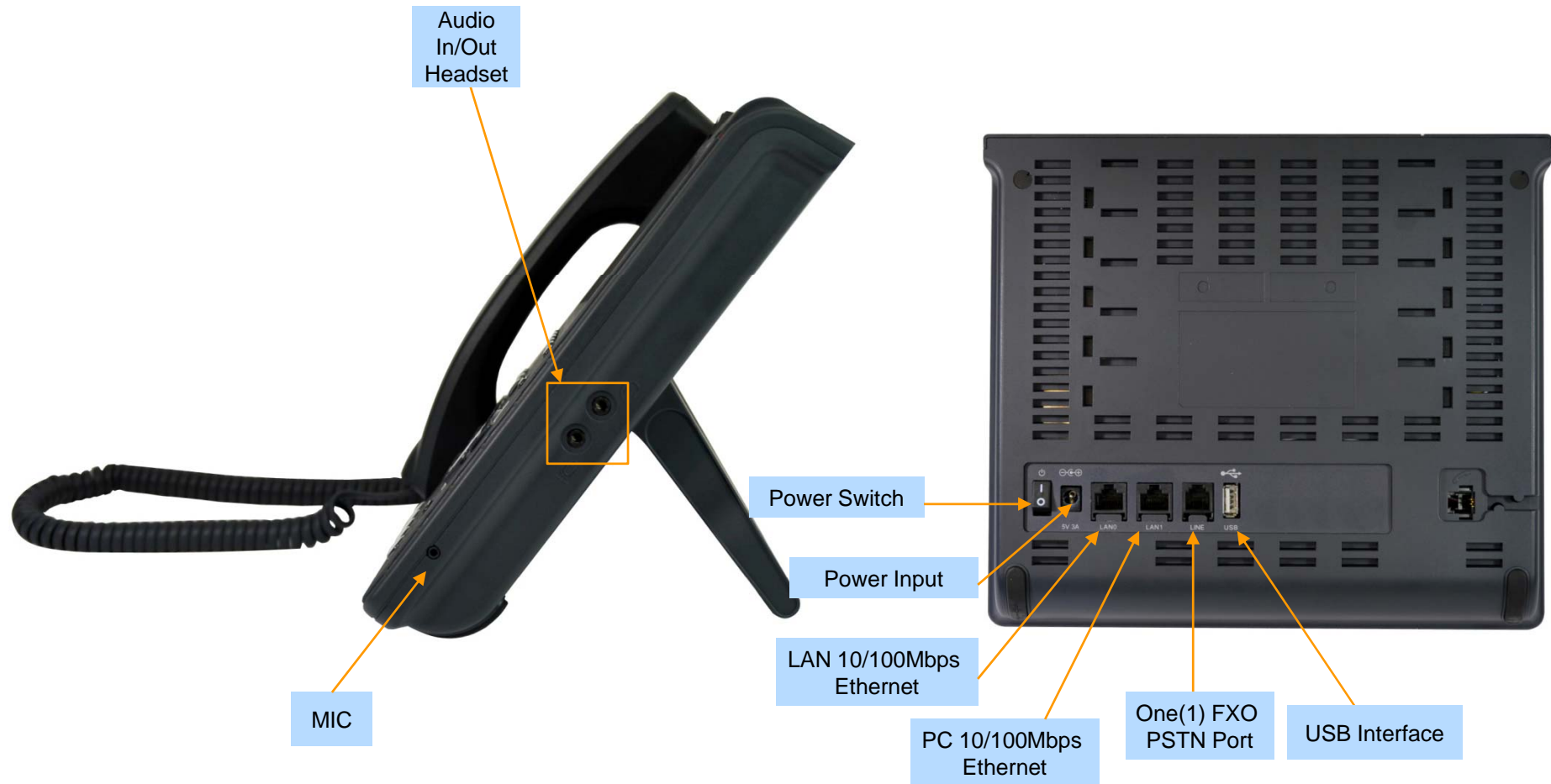



AP-IP160 IP Phone

IP Phone

AP-IP160 IP Phone

Main Features

- 4 Text Line Graphic LCD Display
- 16 Speed-Dial Keys with User Presence LED
- 4 Soft Key for Call Control
- Various Function Keys
- H.323/SIP Concurrent VoIP Signaling Stack Embedded
- High-performance Voice Codec Support
 - G.711/G.726/G.729/G.723, etc
- Two(2) 10/100Mbps Fast Ethernet (IP Share ,etc)
- High Quality Speaker Phone Features (Acoustic Echo Canceller)
- Powerful Network Protocols (PPPoE, DHCP, Static Routing, etc)
- Firmware Upgradeable Architecture
- VPMS (VoIP Plug&Play Management System) for Large Scale Deployment
- Advanced Voice QoS Mechanism

IP Phone

AP-IP160 IP Phone

RISC
CPU

High-end
DSP

Hardware Specification

- RISC Microprocessor Computing Power
- 4 Text Line Graphic LCD
- Navigation Key for Menu Search
- High-end Programmable DSP Hardware Architecture
- High quality Audio and Voice Interface
 - Stereo Audio Input & Output Connector
- Network Interface
 - Two(2) 10/100Mbps Fast Ethernet
- PSTN Interface
 - One(1) FXO(RJ11) interface
- Power Supply
 - *External DC adaptor (5V)*
 - *Power Switch*
 - *PoE (Power over Ethernet)*

IP Phone

AP-IP160 IP Phone

RISC
CPU

High-end
DSP

Hardware Specification



AddPac

www.addpac.com

IP Phone

AP-IP160 IP Phone

RISC
CPU

High-end
DSP

Hardware Specification

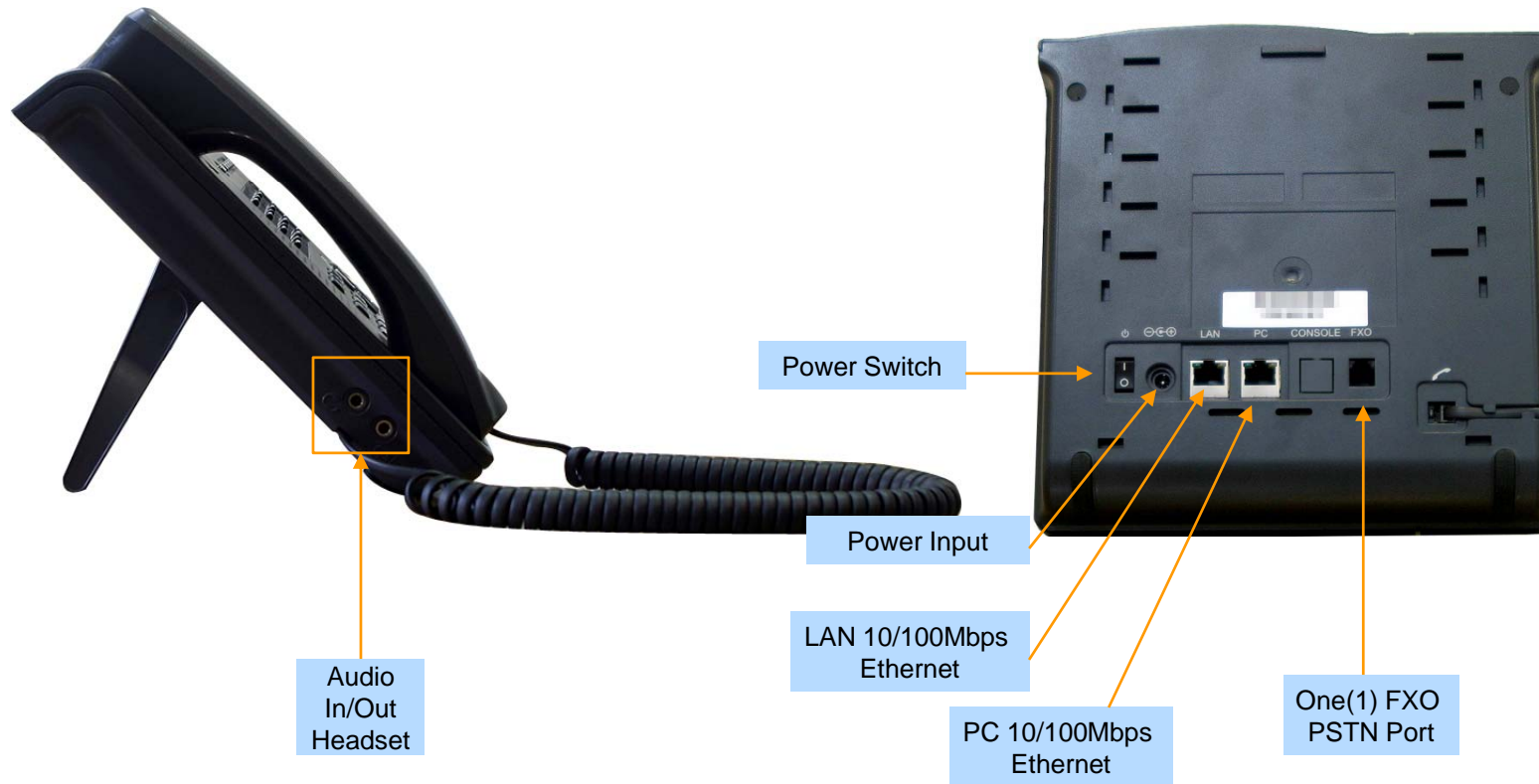



AP-IP120 IP Phone

IP Phone

AP-IP120 IP Phone

Main Features

- 4 Text Line Graphic LCD Display
- 12 Speed-Dial Keys with User Presence LED
- 4 Soft Key for Call Control
- Various Function Keys
- H.323/SIP Concurrent VoIP Signaling Stack Embedded
- High-performance Voice Codec Support
 - G.711/G.726/G.729/G.723, etc
- Two(2) 10/100Mbps Fast Ethernet (IP Share ,etc)
- High Quality Speaker Phone Features (Acoustic Echo Canceller)
- Powerful Network Protocols (PPPoE, DHCP, Static Routing, etc)
- Firmware Upgradeable Architecture
- VPMS (VoIP Plug&Play Management System) for Large Scale Deployment
- Advanced Voice QoS Mechanism

IP Phone

AP-IP120 IP Phone

RISC
CPU

High-end
DSP

Hardware Specification

- RISC Microprocessor Computing Power
- 4 Text Line Graphic LCD
- Navigation Key for Menu Search
- High-end Programmable DSP Hardware Architecture
- High quality Audio and Voice Interface
 - Stereo Audio Input & Output Connector
- Network Interface
 - Two(2) 10/100Mbps Fast Ethernet
- PSTN Interface
 - One(1) FXO(RJ11) interface
- Power Supply
 - *External DC adaptor (5V)*
 - *PoE (Power over Ethernet)*

IP Phone

AP-IP120 IP Phone

RISC
CPU

High-end
DSP

Hardware Specification





Thank you!

AddPac Technology Co., Ltd.
Sales and Marketing

Phone +82.2.568.3848 (KOREA)

FAX +82.2.568.3847 (KOREA)

E-mail : sales@addpac.com