

AP-SPS2000 SIP Paging Server

High-performance Next Generation SIP Paging Server Solution

Preliminary Product Overview

(Without notice, following described technical spec. can be changed)



AddPac

AddPac Technology

2015, Sales and Marketing

www.addpac.com

Contents

- Product Overview
- Hardware Specification
- System Redundancy Features
- Software Service
- Network Service and Features
- SIP Paging Terminals
- SIP Paging Server Service Diagram
- Paging Scenario & Service Features
- Ordering Information



Product Overview

AP-SPS2000 SIP Paging Server

- SIP Application Server, Proxy, Registrar and Location Server
- SIP Paging Server Service
- Standalone SIP Paging & Broadcasting Service Support
- Legacy IP-PBX Clone Mode Support (Trunk, etc)
- RTP(Real-time Transport Protocol) Support for Unicast and Multicast Paging Service
- Internal & External RTP Routing Service Support
- Web based SPMS(SIP Paging Management Software) Support
- Various Paging Service Mode Support (Ex : Scheduled Broadcasting, etc)
- Various SIP Paging Terminal Support (SIP Phone, etc) Beside AddPac Product
- Paging Service Support via SIP IP Phone
- Paging Service Support via AddPac Smart Communicator (PC based AddPac Multimedia Manager)
- TTS Paging Service Support
- Dual System Redundancy Architecture
 - Two(2) Gigabit Ethernet Interface / System
- High Performance RISC Architecture
- Powerful Network Protocols (PPPoE, DHCP, Static Routing, etc)
- Firmware Upgradeable Architecture
- Dual Redundancy Power Module

Product Highlights

AP-SPS2000 SIP Paging Server

Advanced SIP Paging Server

SIP Application Server, Proxy, Registrar and Location Server

Standalone SIP Paging & Broadcasting Service Support

Dual System Architecture for Fault Tolerant

Powerful IVR Support

Dual Power Supply System for Redundancy

Support the Various SIP Paging Terminals

APOS™ Technology Multimedia Network Protocol

Various paging Service Support (Ex : schedule paging service, etc)

IPv4/IPv6 based Network Protocol & Voice Traffic QoS

Broadband IP Networking with Dual Gigabit Ethernet

Smart Multimedia Management for Operation & Management

AddPac

www.addpac.com

Hardware Specification

AP-SPS2000 SIP Paging Server

A square logo with a dark blue background and a white border. The text "RISC" is positioned above "CPU" in a white, sans-serif font.

RISC
CPU

- 64bit High-End Microprocessor Computing Power
- Main Chassis
 - Dual Redundancy CPU Boards for System Fault Tolerant
 - Two(2) 10/100/1000Mbps Gigabit Ethernet
 - One(1) RS-232C Console (RJ45)
 - Two(2) 3.5 Inch Hard Disk Interface Slot (RAID 1)
 - Dual Redundancy Power Supply Module
 - Hot-Swap Features

Hardware Specification

AP-SPS2000 SIP Paging Server



AP-SPS2000 Front Side

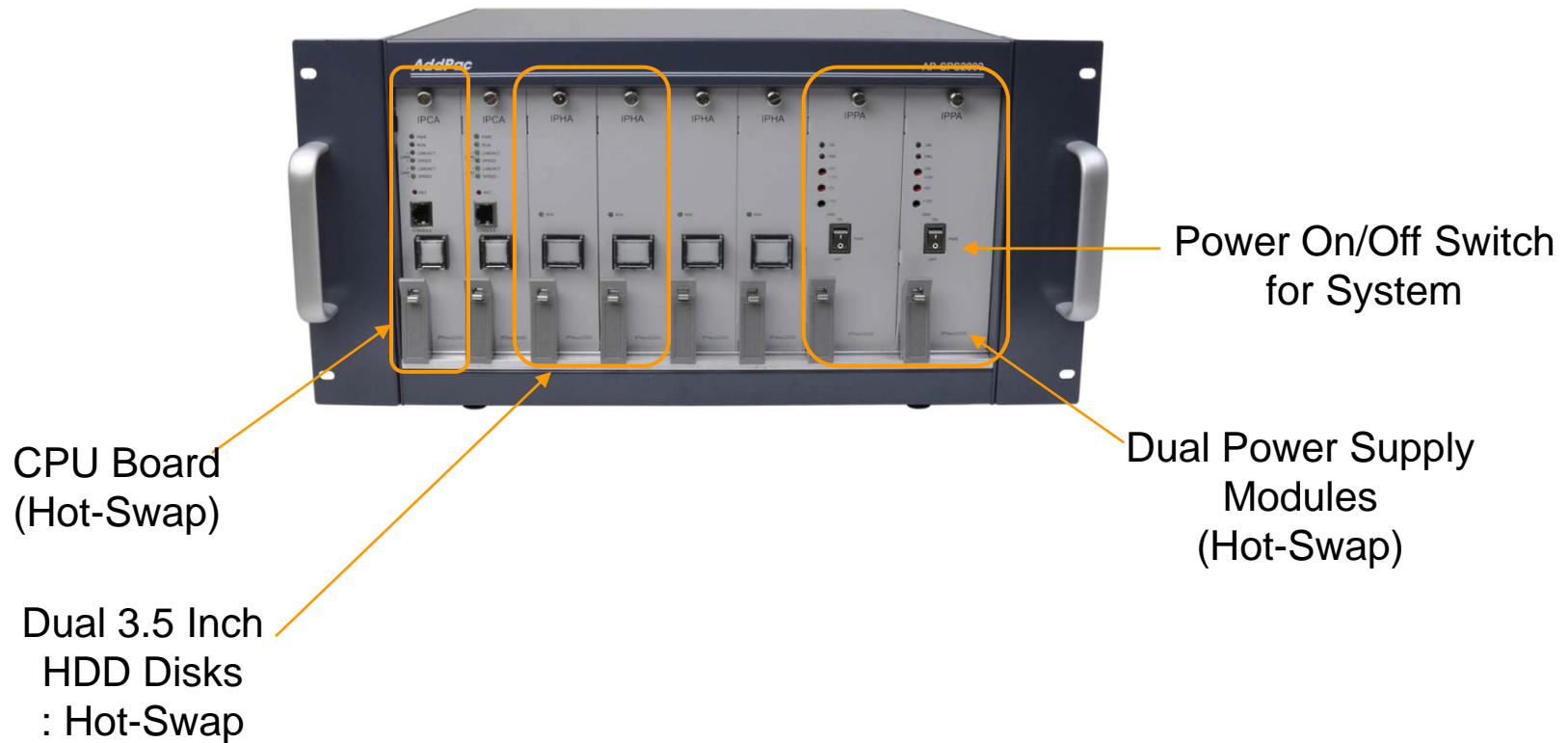

Hardware Specification

AP-SPS2000 SIP Paging Server

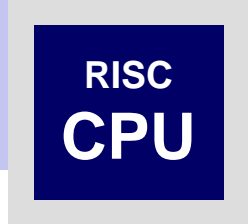

AP-SPS2000 Back Side

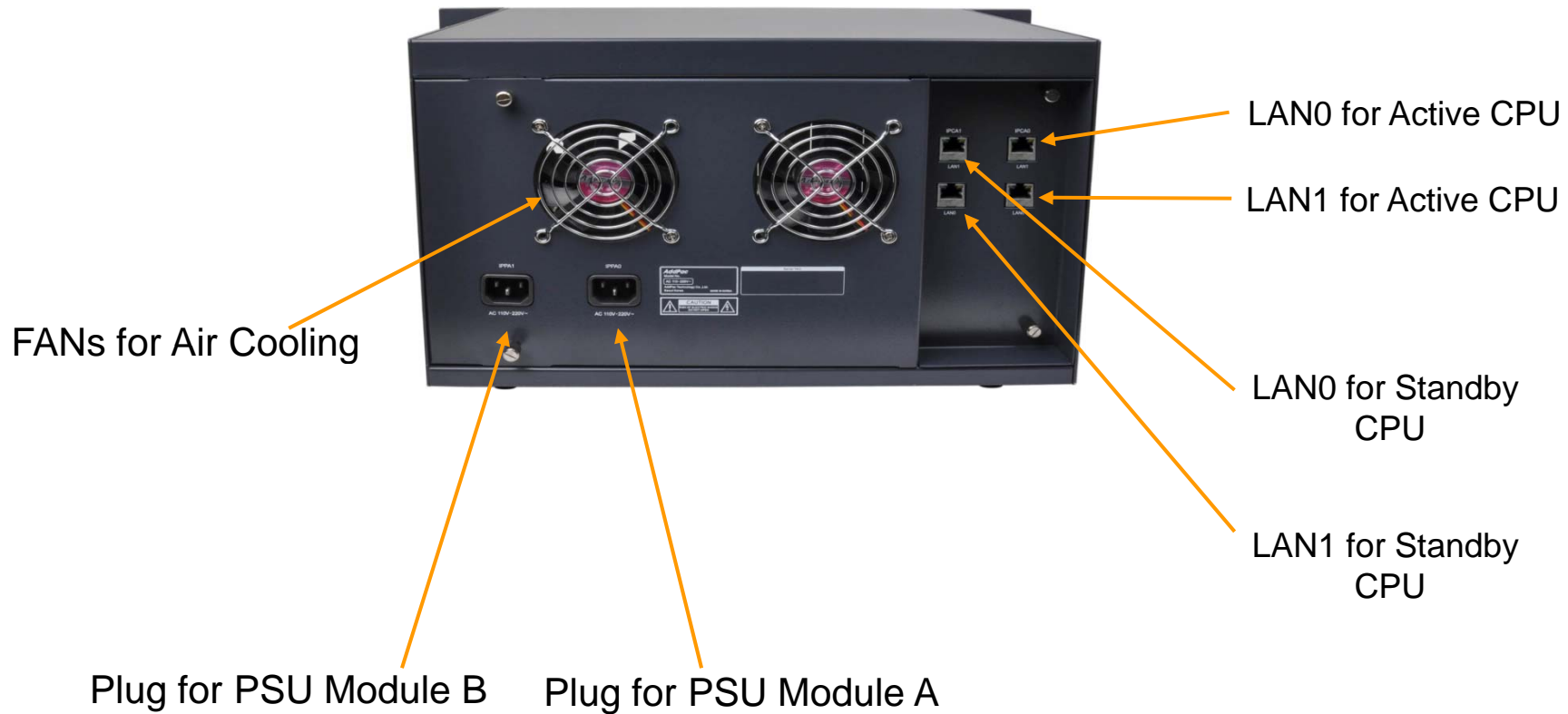

System Redundancy Features

AP-SPS2000 SIP Paging Server

AP-SPS2000 System Block Diagram

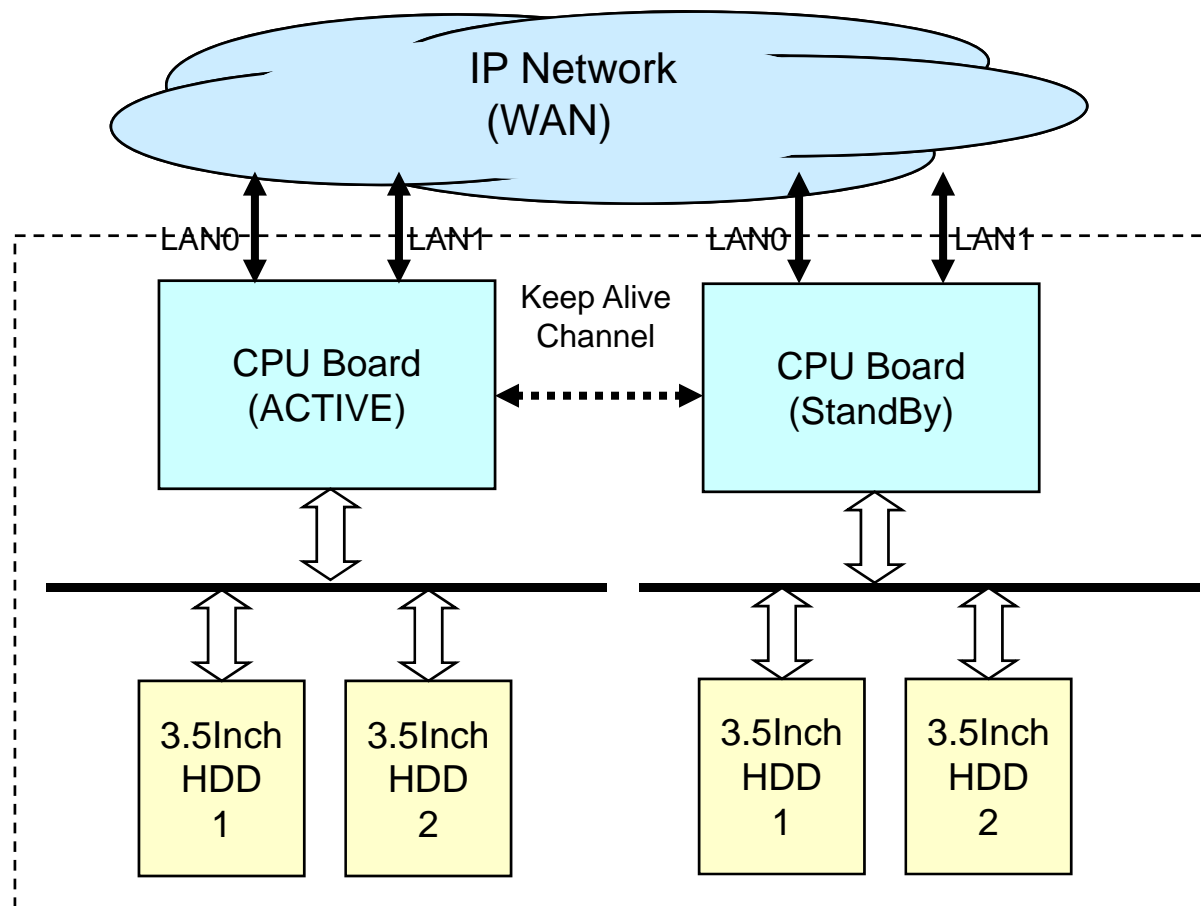

Software Service

AP-SPS2000 SIP Paging Server

- **Built-in AddPac APOS Internetworking Software**
 - Scalability, Functionality, and Stability Features
 - Advanced SIP Paging Server Service Features
 - QoS Control Features
- **Web based SPMS**
(SIP Paging Management Service) Support
- **Various Broadcasting Management Service**
- **Firmware Upgradeable Architecture**
- **Industry Standard Network Protocol Features**

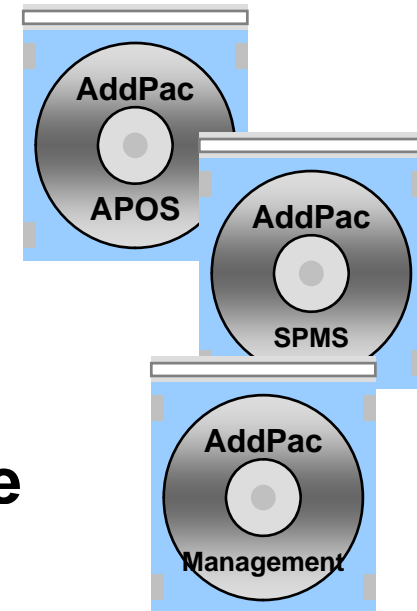

SIP Signaling Service and Features

AP-SPS2000 SIP Paging Server

- **Signaling Server**

- SIP Application Server, Proxy, Registrar and Location Server (RFC3261)
- Multiple ITSP Trunk with SIP & H.323 Accounts Support
 - IP UA Client Role for Registering to ITSP SIP Server

- **IVR & Auto Attendant**

- Default Auto Attendant Support
- Interactive Voice Response (IVR)
 - Provides with GUI-based Smart IVR Scenario Editor
 - Upload/Download Scenario by Smart IVR Scenario Editor
 - Supports Multiple Concurrent Scenarios
 - Supports Recordable IVR Prompts

Network Service and Features

AP-SPS2000 SIP Paging Service

- **Basic Network Protocols**
 - ARP, IP, IPv6, TCP, UDP, ICMP, ICMPv6, SCTP, IGMP, MLD
- **Routing Protocol**
 - IPv4 : Static
 - IPv6 : Static
- **Service Protocol**
 - FTP, Telnet, TFTP, DHCP Server/Relay, SNMP Server
 - CDP (Cisco Discovery Protocol)
 - DNS Resolver , DDNS(nsupdate)
 - Bridge
 - Syslog
 - IP/IPv6 policy control (QoS)
 - VPDN (Virtual Private Dial-up Network : L2TP Server)

Network Service and Features

AP-SPS2000 SIP Paging Service

- **IPv4/IPv6 Interworking**
 - NAT/PAT for IPv4
 - IP connect (formerly ip-share) and device cascade for IPv4
 - IP/IP, IP/GRE tunneling
 - NAT-PT
 - 6to4, Autoconfig tunneling
- **IPv4 Address Configuration**
 - Fixed (Static)
 - DHCP
 - PPPoE
- **IPv6 Address Configuration**
 - Fixed (Static)
 - EUI-64
 - Autoconfig (Neighbor Advertisement and Solicitation)

Network Service and Features

AP-SPS2000 SIP Paging Service

- **Miscellaneous**

- Standard & Extended IPv4/IPv6 Access List
- Multi-level User Account Management
- IP accounting
- fsh (Embedded file system shell)
- STUN Client

Network Service and Features

AP-SPS2000 SIP Paging Service



SNMP MIBs

- MIB-II
- RMON MIBs (Statistics, History, Alarm, Hosts Group)
- RFC2465 Management Information Base for IP Version 6: Textual Conventions and General Group
- RFC2466 Management Information Base for IP Version 6: ICMPv6 Group
- RFC2452 IP Version 6 Management Information Base for the Transmission Control Protocol
- RFC2454 IP Version 6 Management Information Base for the User Datagram Protocol
- AddPac Enterprise MIBs
- etc



SIP IP Phones for Paging Service

IP Phones for AddPac IP-PBX

	AP-IP300	AP-IP250	AP-IP230	AP-IP160	AP-IP120	AP-IP90
						
LCD Size	4.3 Inch Color LCD	4.3 Inch Color LCD	5 Inch Color LCD	4 Text Line Graphic LCD	4 Text Line Graphic LCD	4 Text Line Graphic LCD
Touch Screen	N/A	Support	Support	N/A	N/A	N/A
Speed-Dial Keys	25 Key with Presence LED	Touch Screen based 25 Keys	Touch Screen based 25 Keys	16 Key with Presence LED	12 Key with Presence LED	N/A
Voice Codec	G.711/G.726/ G.729/G.723	G.711/G.726/ G.729/G.723	G.711/G.726/ G.729/G.723	G.711/G.726/ G.729/G.723	G.711/G.726/ G.729/G.723	G.711/G.726/ G.729/G.723
Signaling	H.323/SIP	H.323/SIP	H.323/SIP	H.323/SIP	H.323/SIP	H.323/SIP
3-Party Conversation	Support	Support	Support	Support	Support	Support
LAN Port	2	2	2	2	2	2
PoE(Optional)	Support	Support	Support	Support	Support	Support
FXO(Optional)	Support	Support	Support	Support	Support	Support

Smart Communicator

AP-SMP100 SIP Soft Phone (Video/Voice)

- MS-Window based SIP Soft-Phone
- Smart Multimedia (Video/Voice) Soft-Phone
- SIP Real-time Audio/Video Broadcasting Terminal Solution
- Built-In Smart Messenger Function
- Up to 30fps with HD-Resolution
- Video Conference Call Support (AddPac External MCU Inter-working)
- Advanced Voice/Video Traffic QoS
- SIP, H.323* Signaling Support
- Support Various Call Signal via AddPac SIP Paging Server

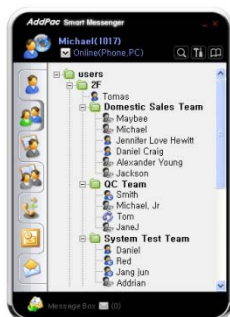



SIP Paging Server Service Diagram

SIP Broadcasting Network Diagram

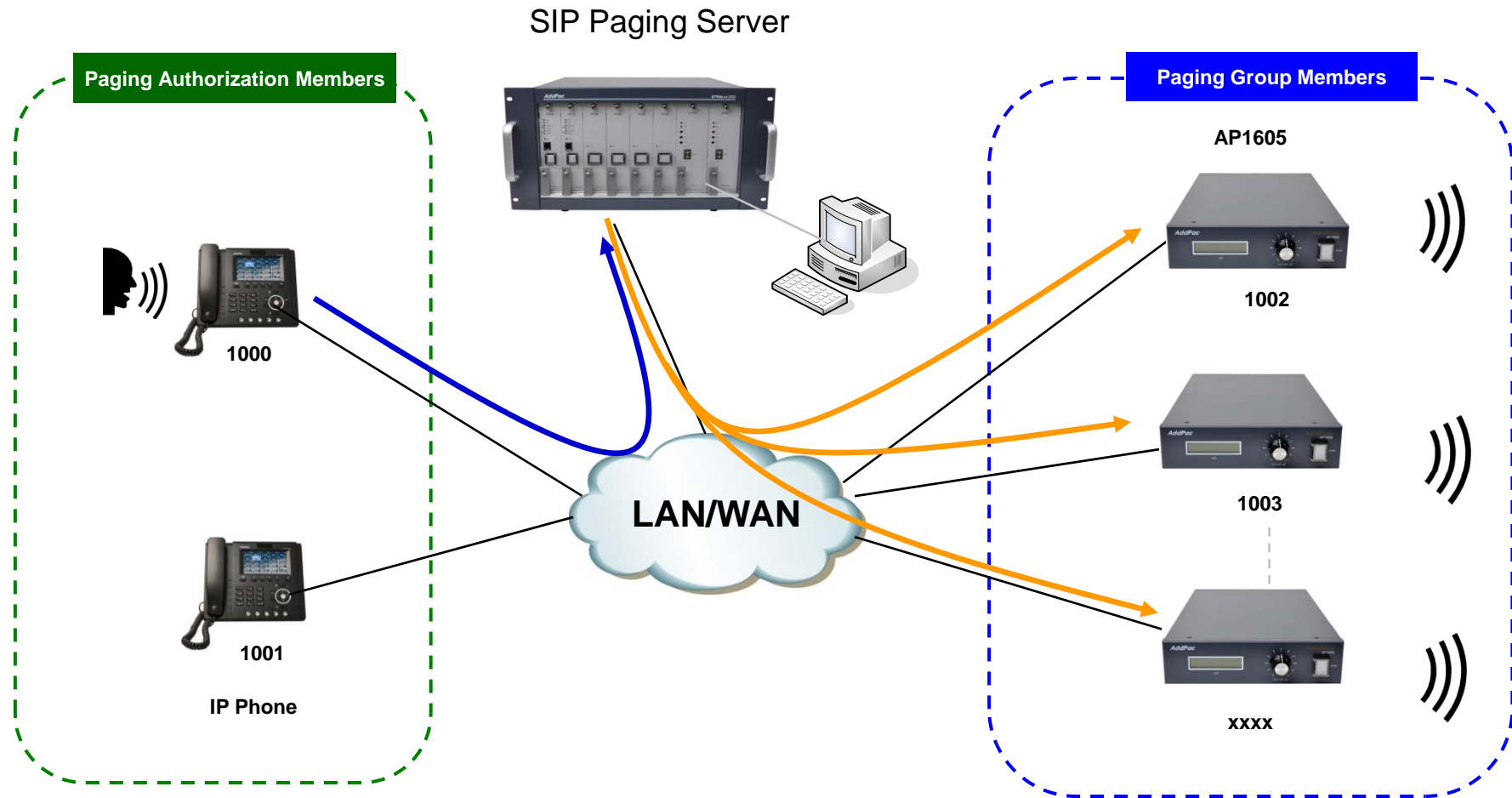

Paging Group Signaling Flow (Standalone Mode)

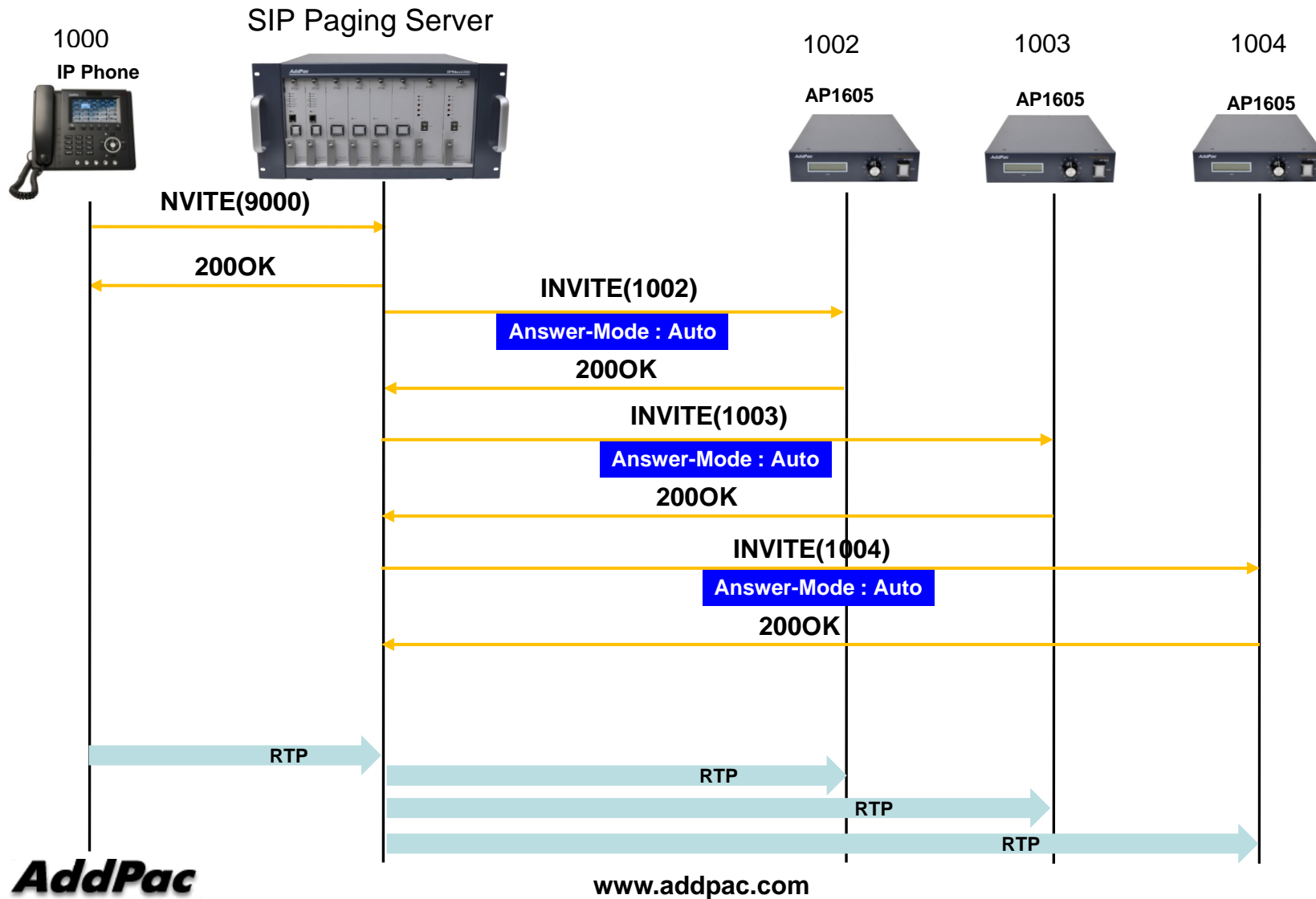

SIP Broadcasting Network Diagram (Clone Mode)

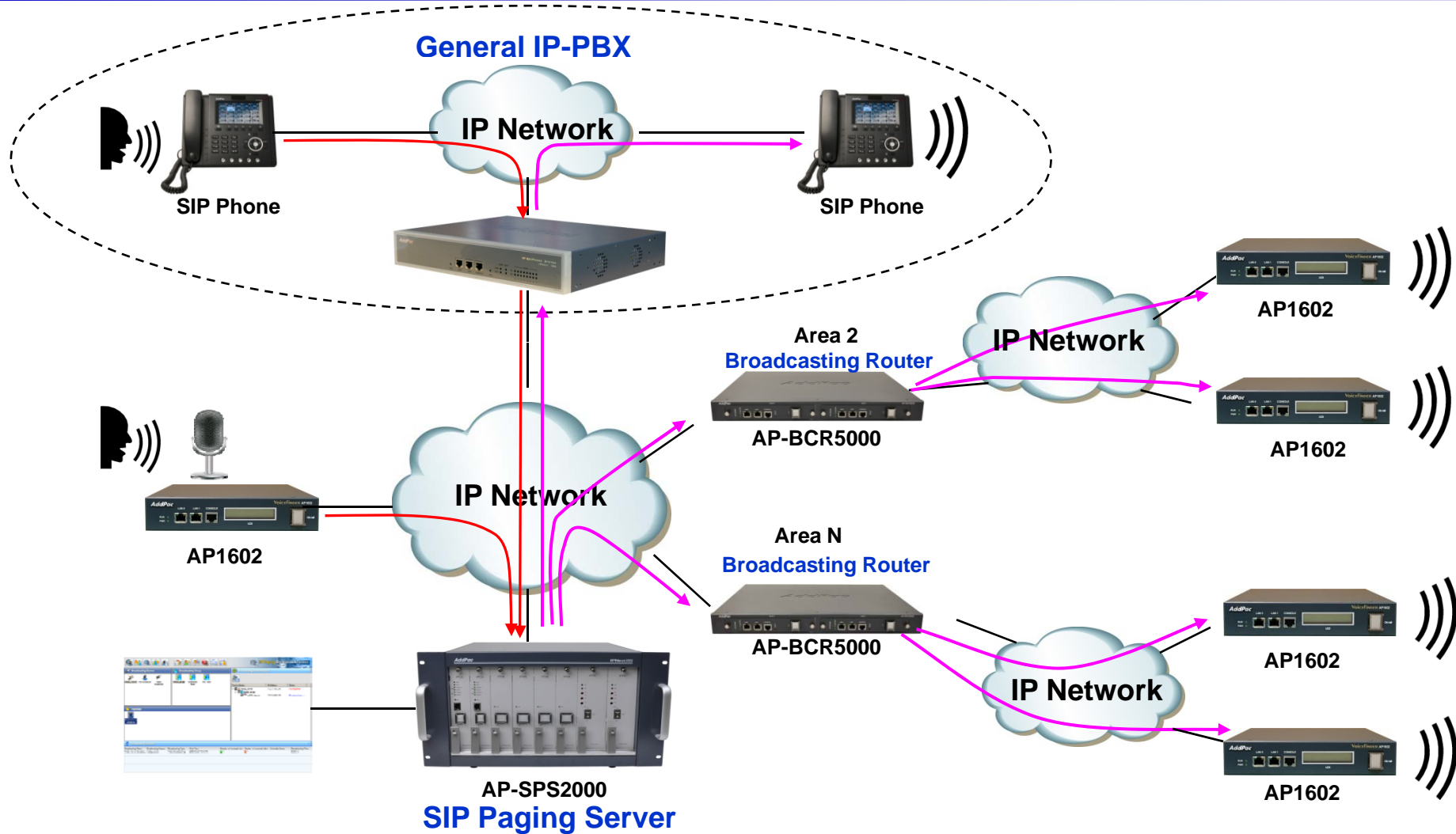

Active – Standby Redundancy

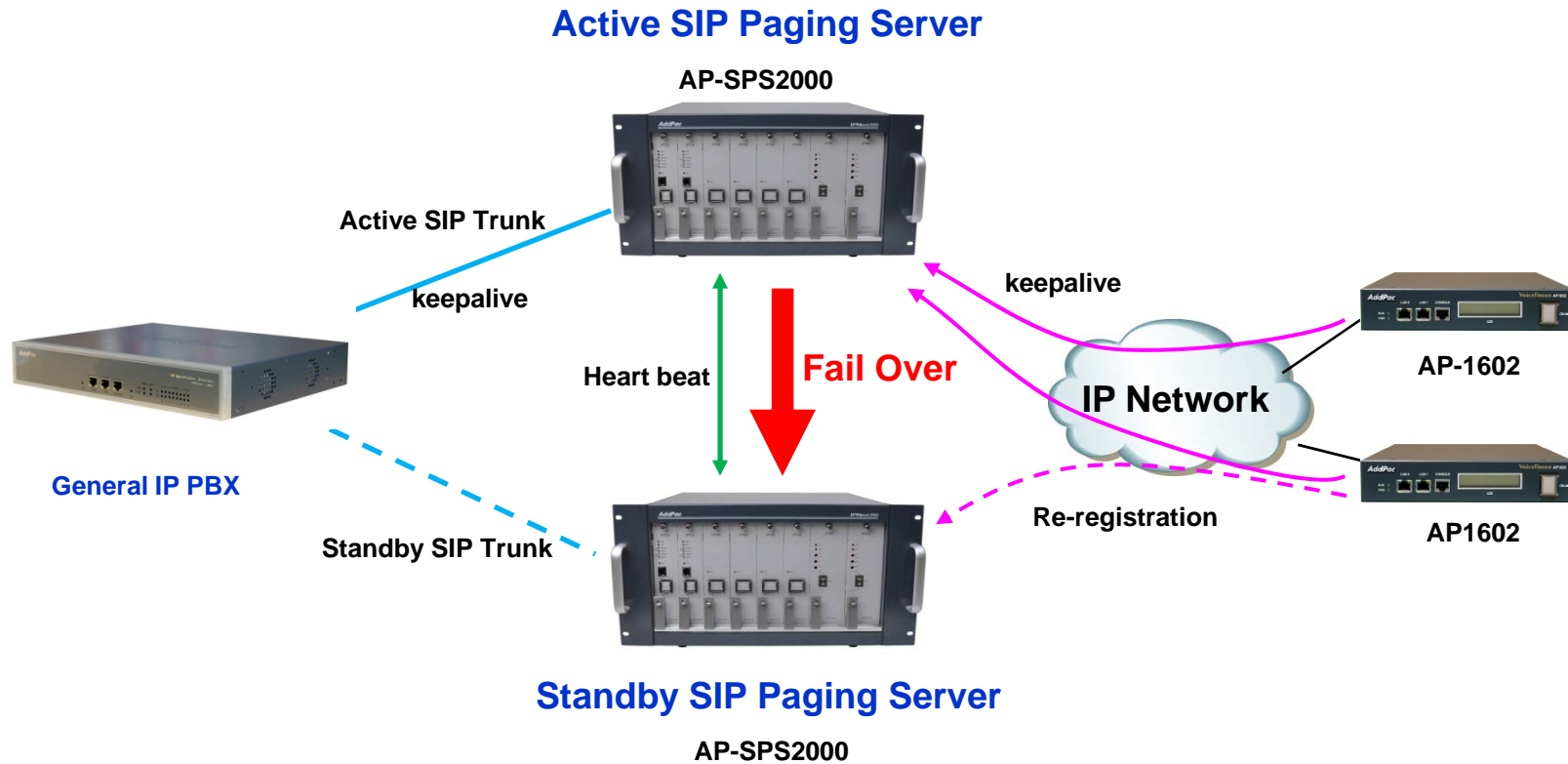

Scalable Broadcasting Routing Server

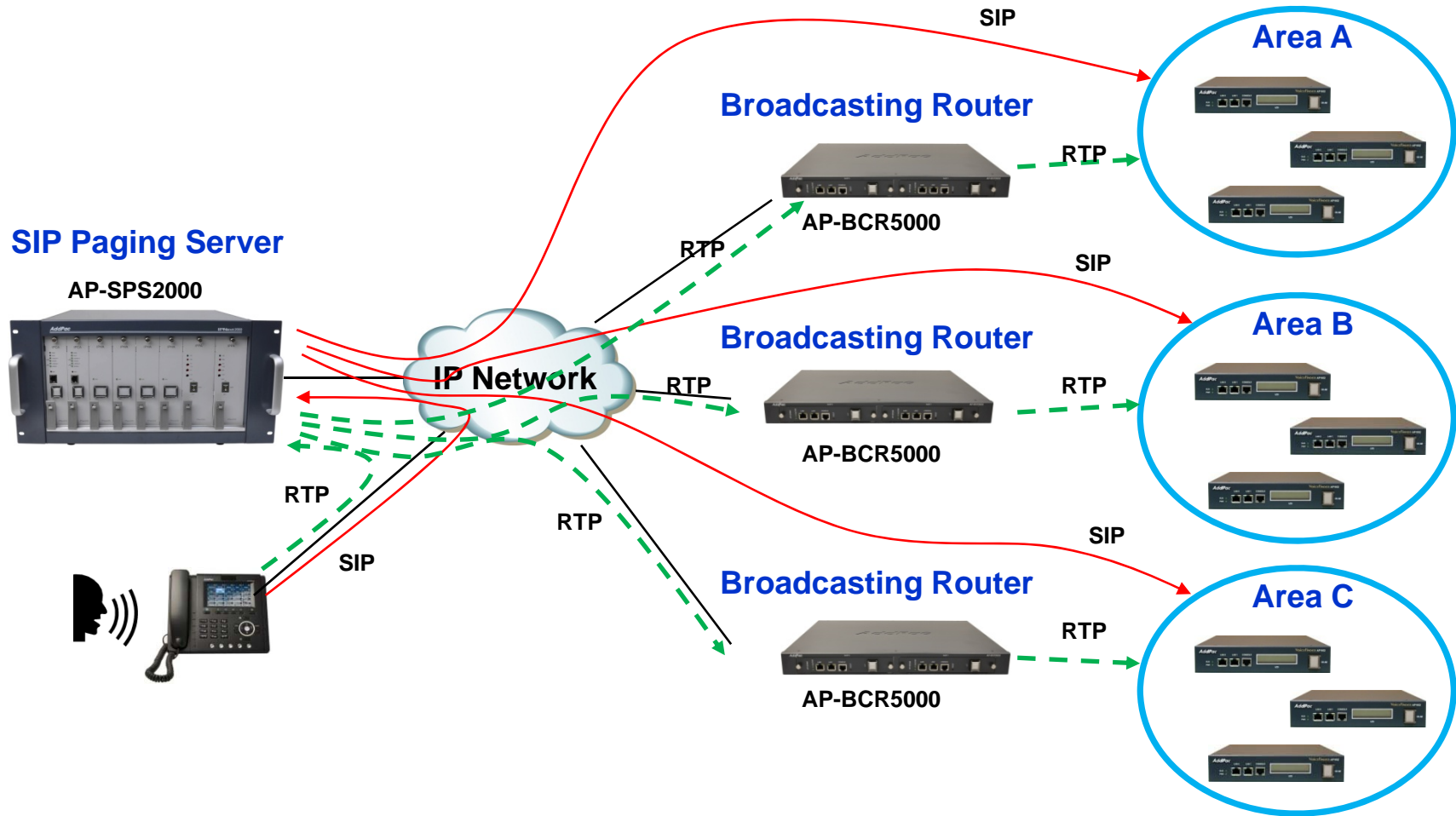



Paging Scenarios & Service Features

Paging Scenarios

- SIP Phone Initiated Real-Time Paging
- SIP Phone Initiated Real-Time Paging via PBX
- SIP Phone Initiated Real-Time Paging to PBX
- Paging to and from PSTN/Mobile Network
- Web Controller Initiated Real-Time Paging
- Add-hoc Paging with IVR
- Recorded Paging with Simultaneous Casting
- Recorded Paging with Individual Casting
- TTS (Text to Speech) Paging
- Audio and SMS Paging by HTTP API
- Scheduled Paging

SIP Phone Initiated Real-Time Paging

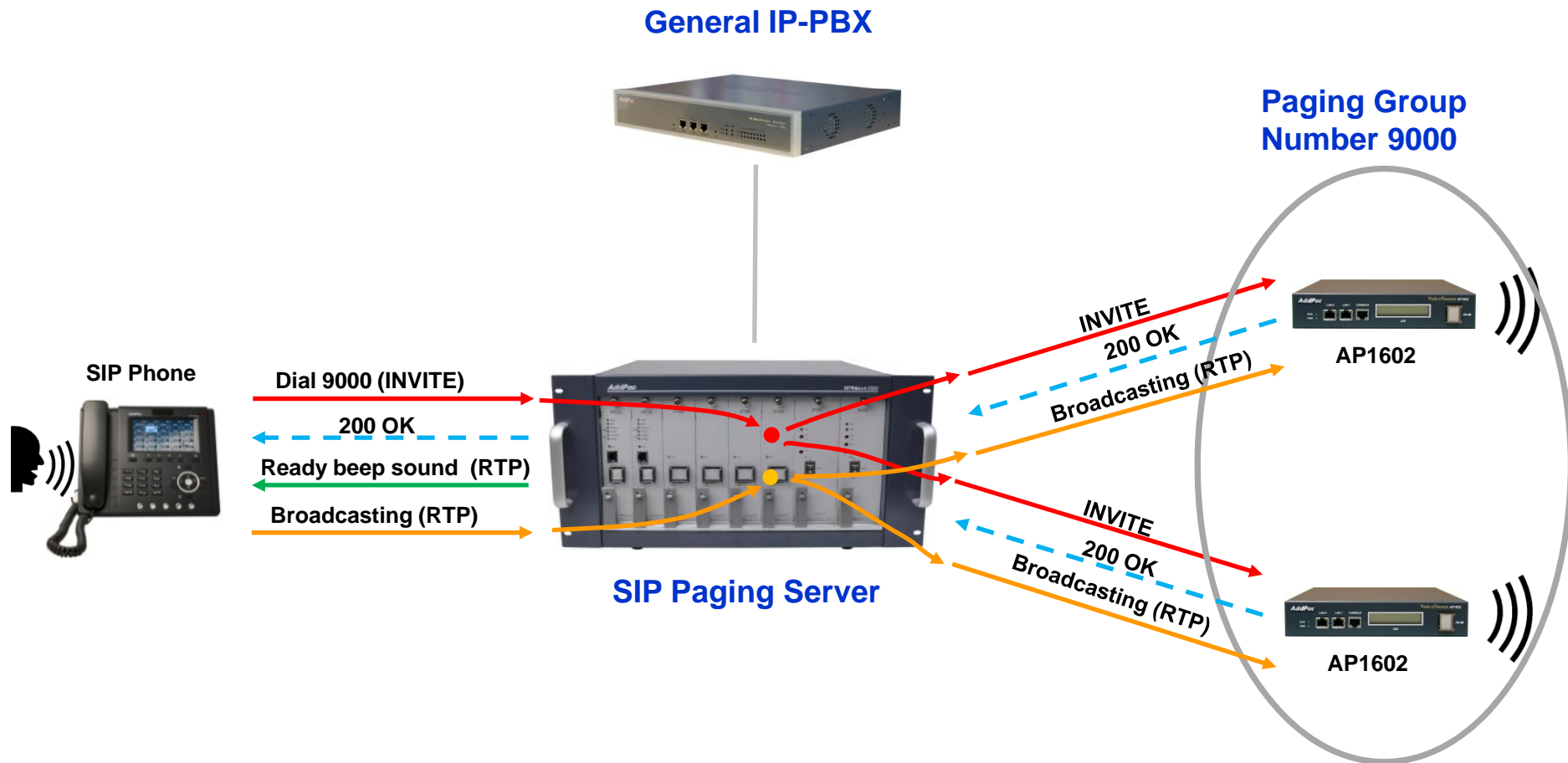

SIP Phone Initiated Real-Time Paging via PBX

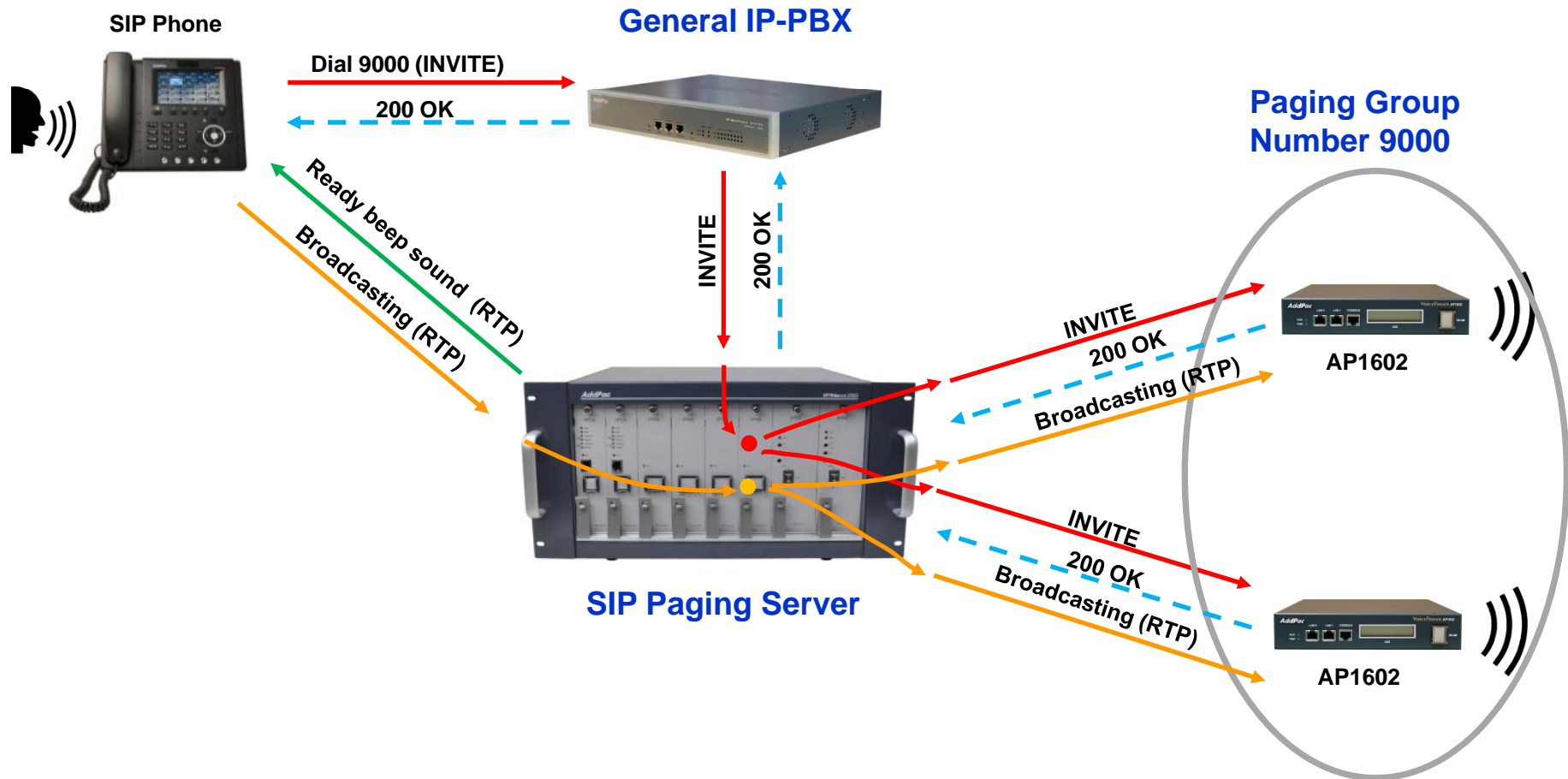

SIP Phone Initiated Real-Time Paging to PBX

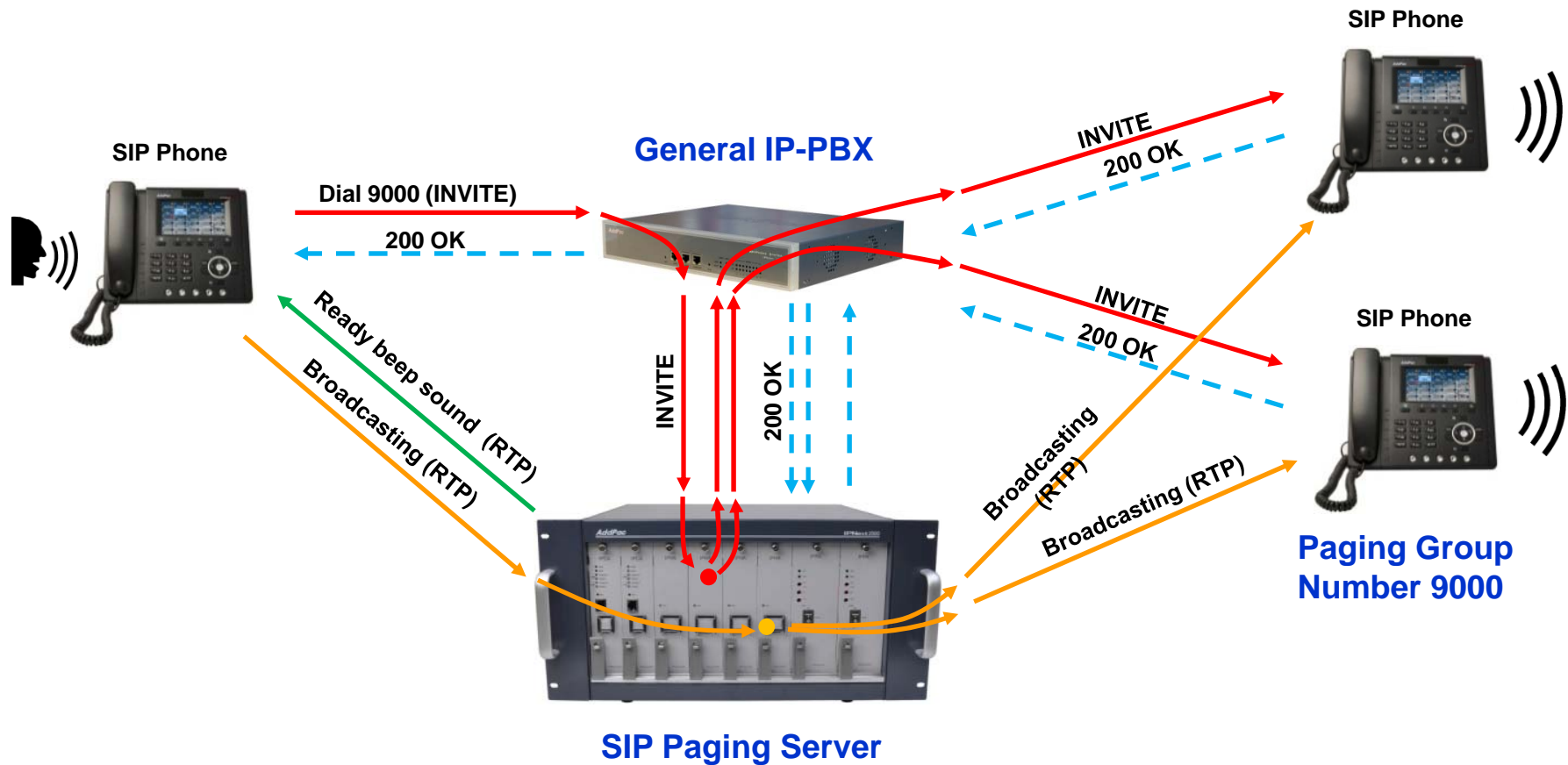

SIP Phone Initiated Real-Time Paging to PBX

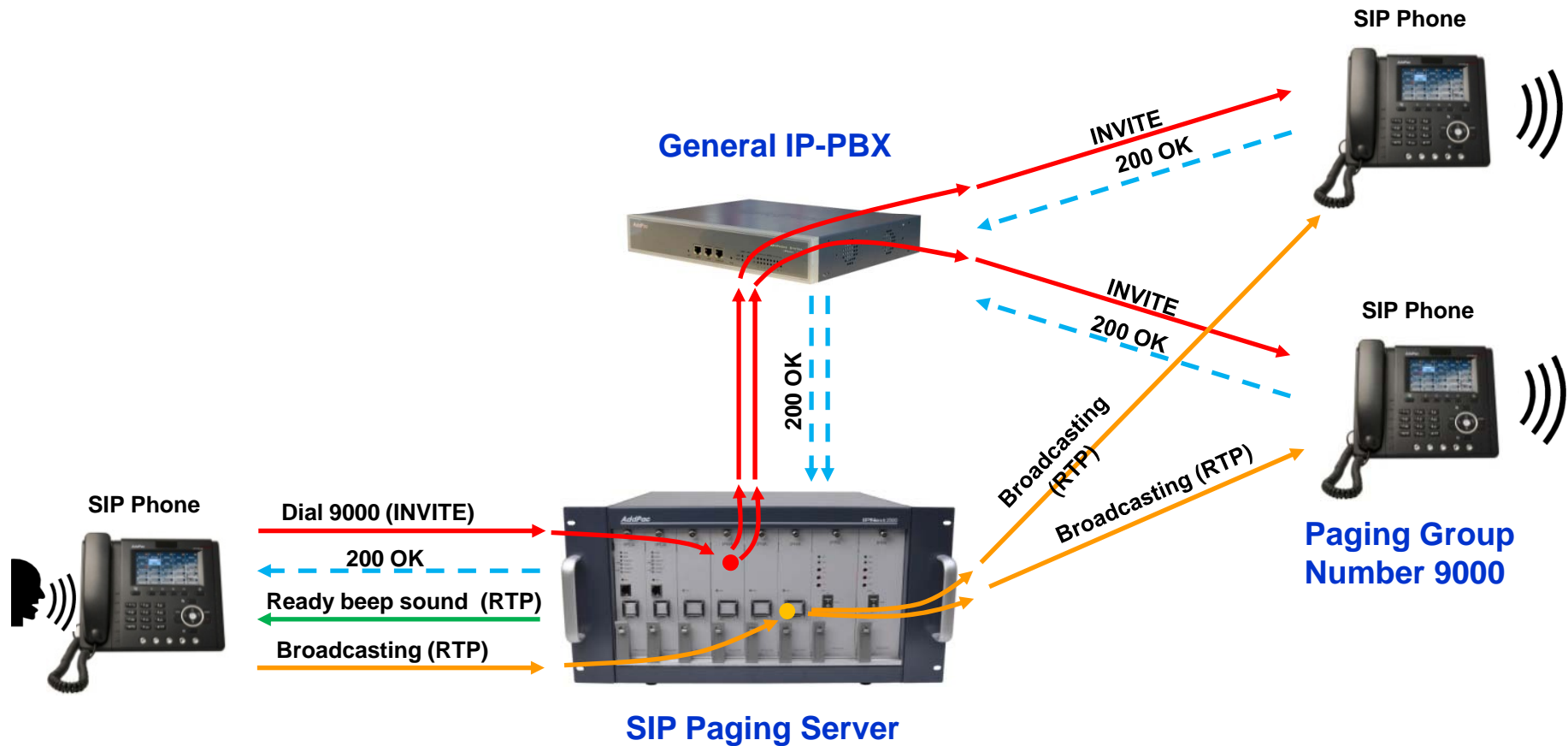

SIP Phone Initiated Real-Time Paging to PSTN and Mobile Network

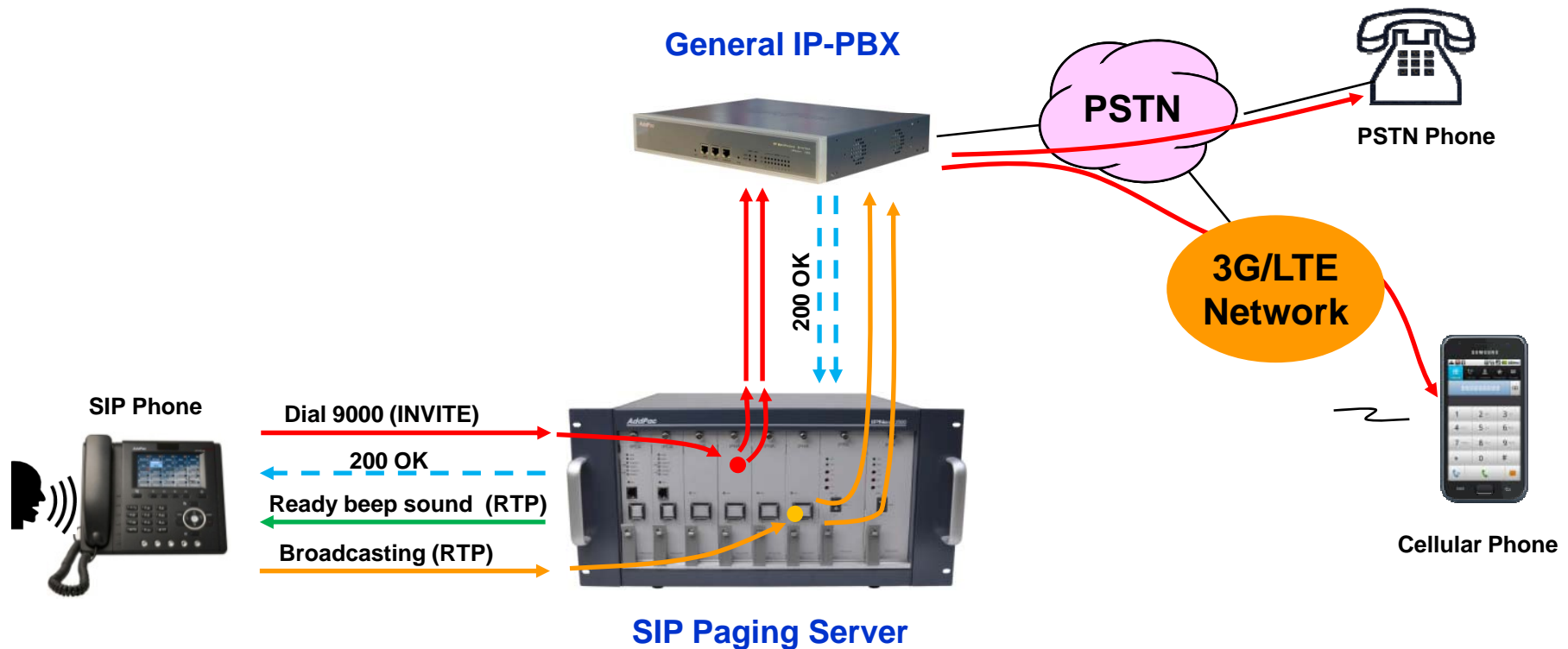

PSTN or Mobile Network Initiated Paging with IVR

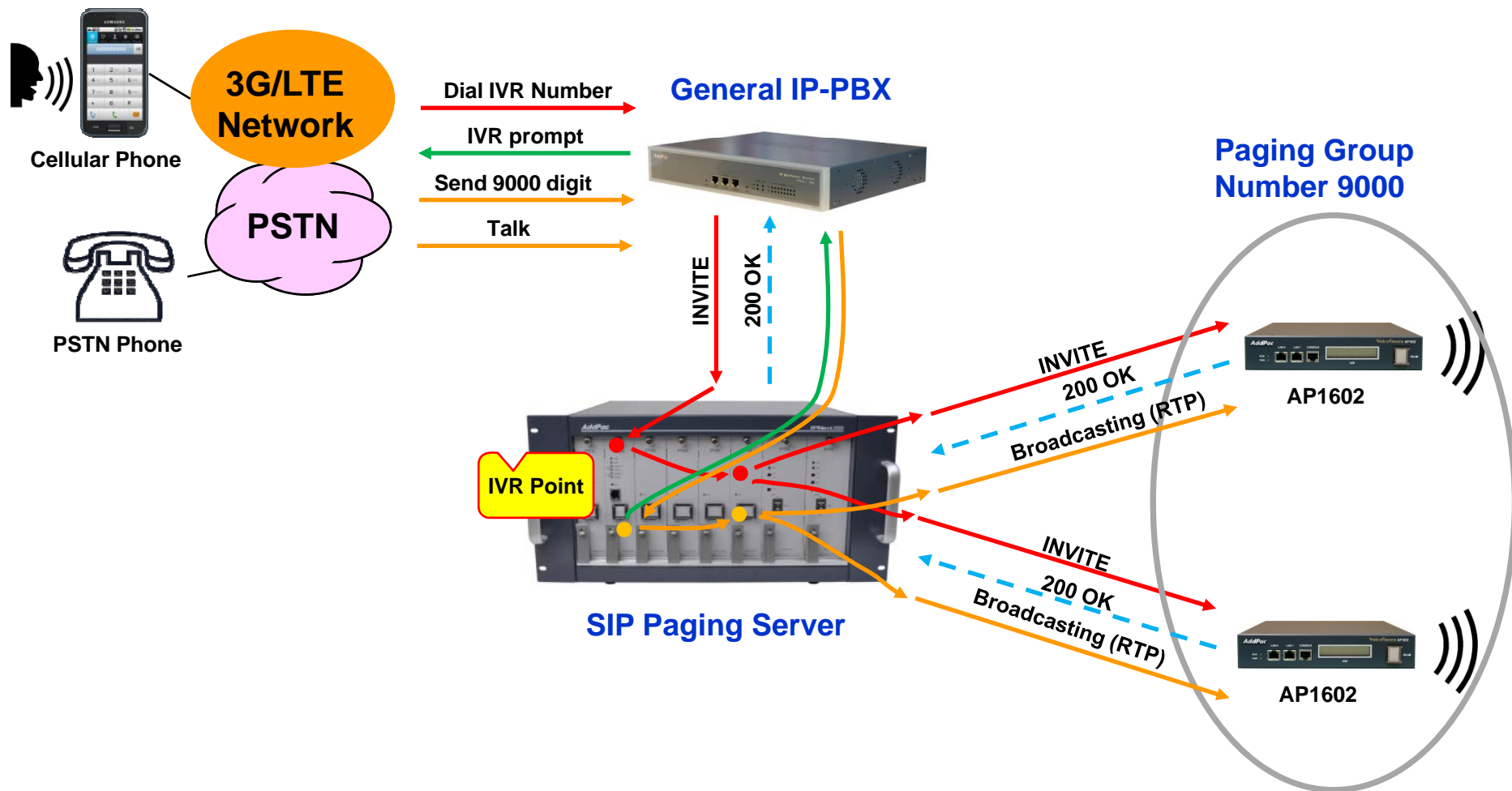

Web Controller Initiated Real-Time Paging (1)

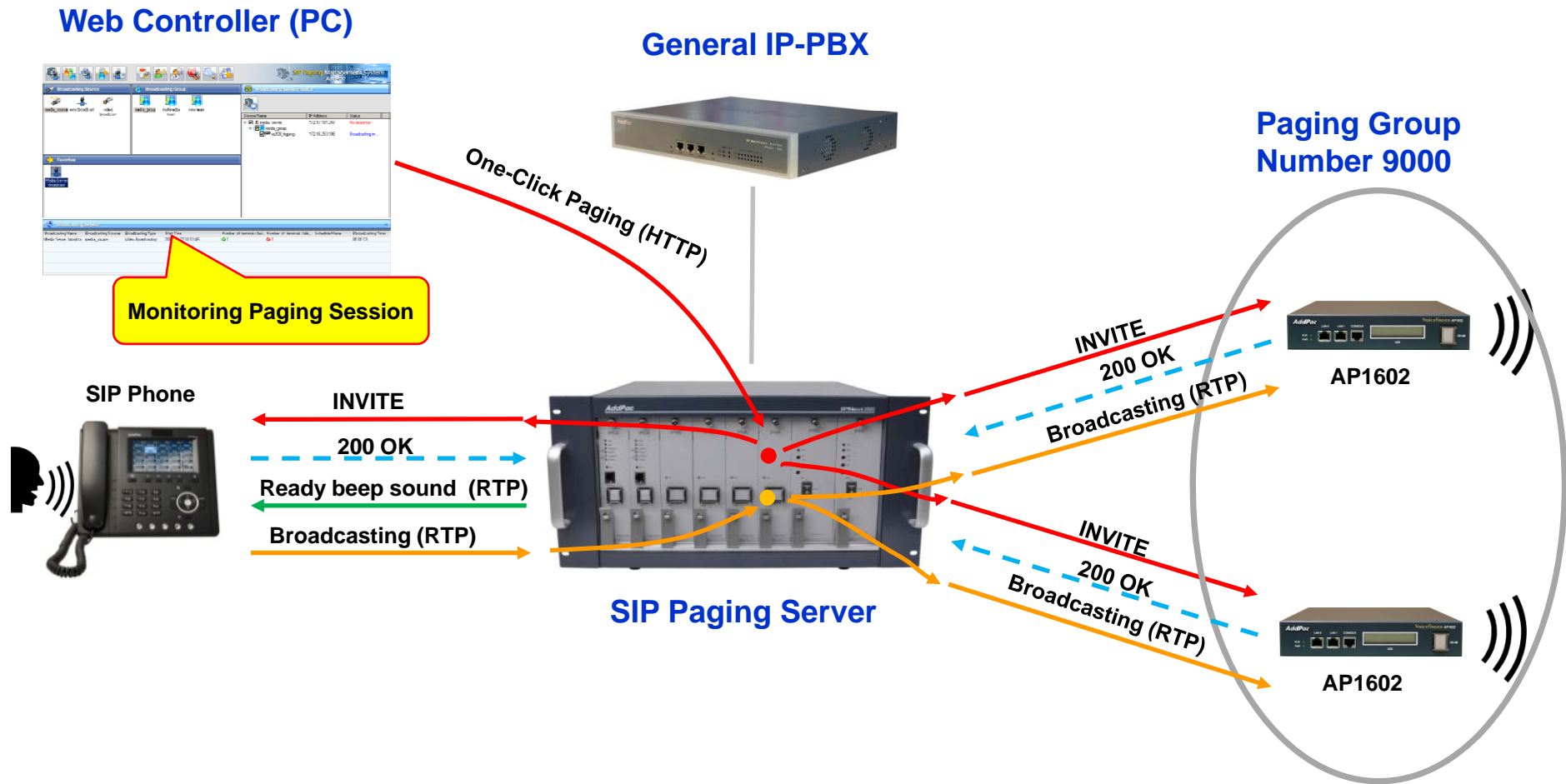

Web Controller Initiated Real-Time Paging (2)

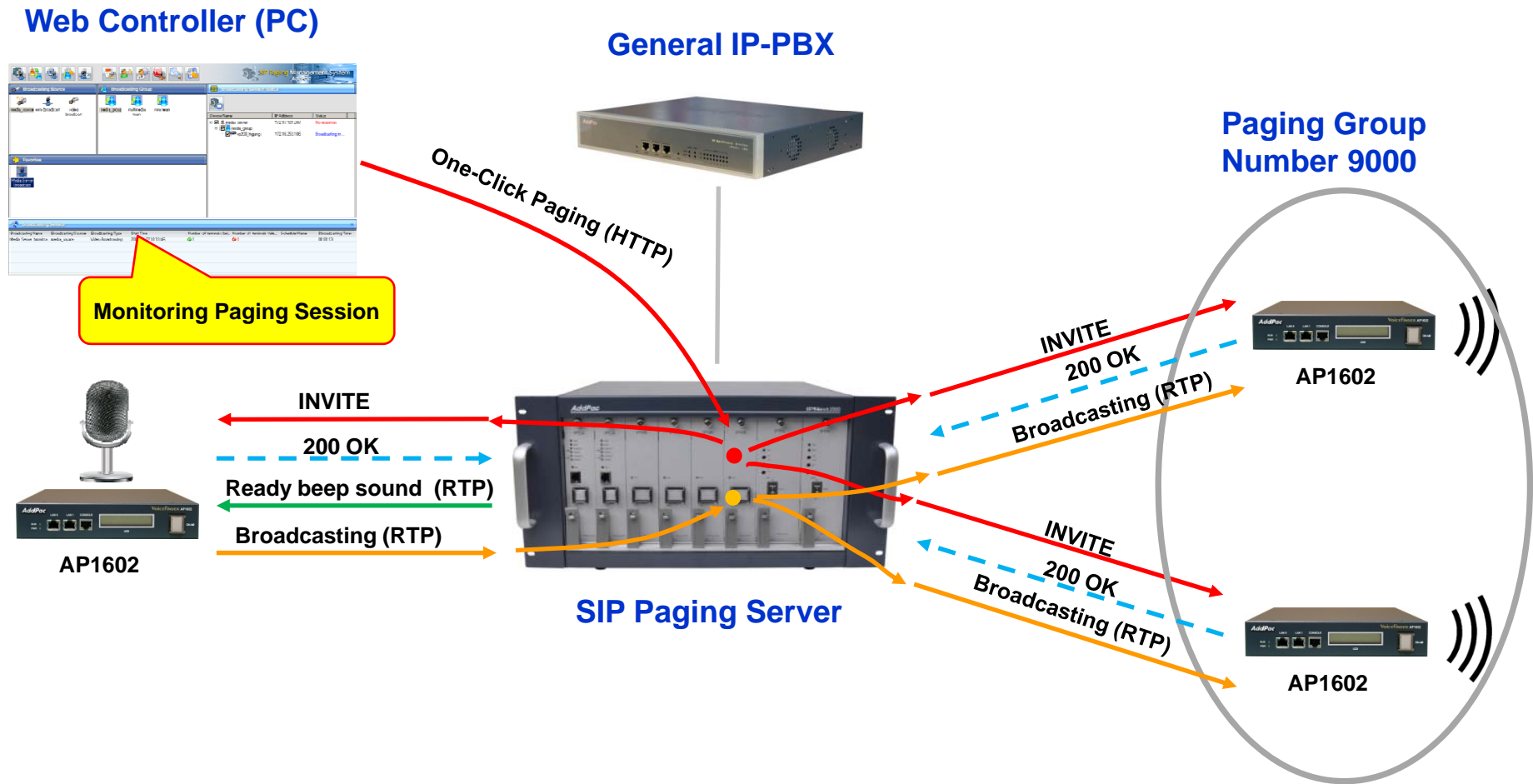

Add-hoc Paging with IVR

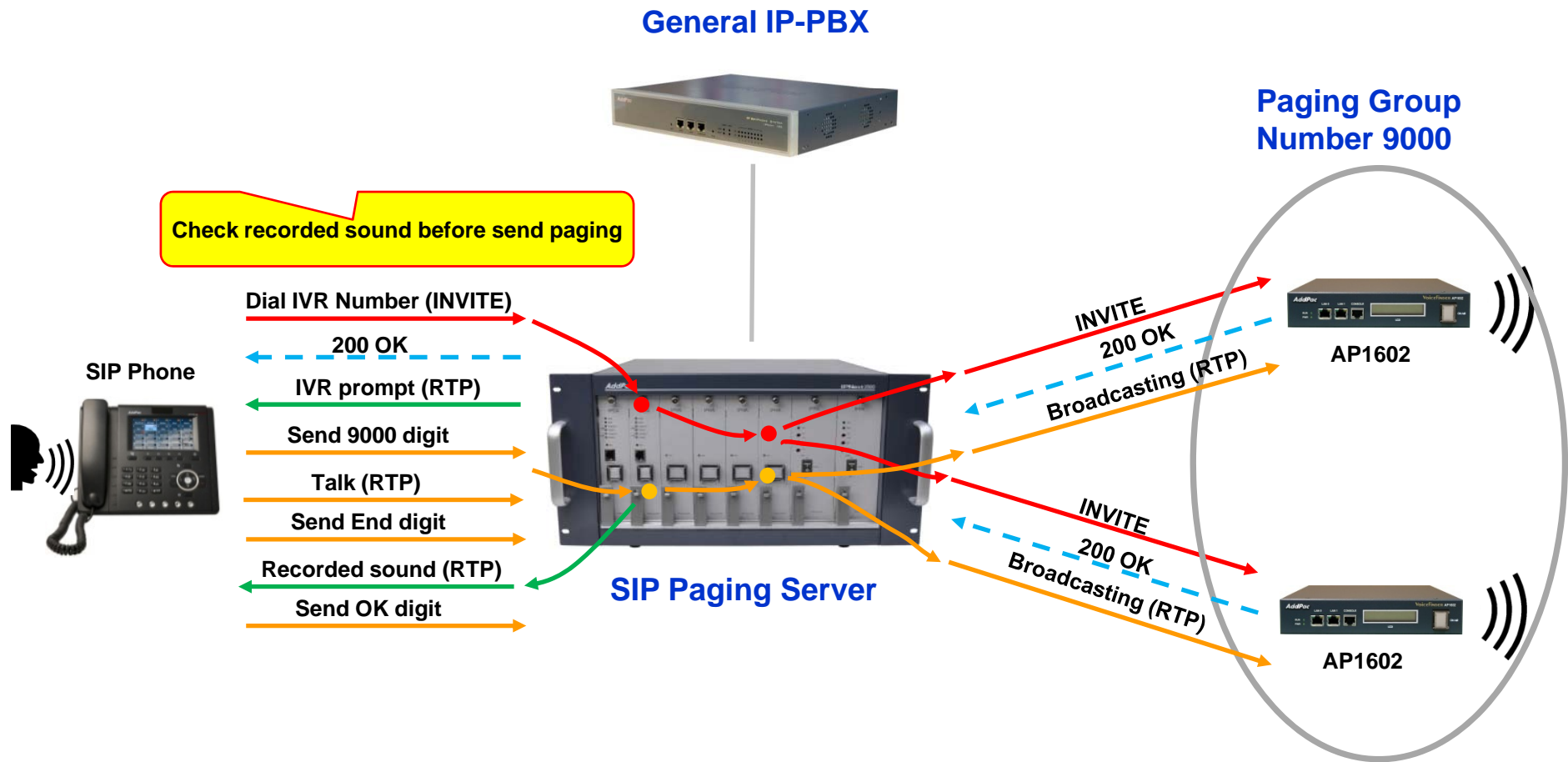

Recorded Paging with Simultaneous Casting

Web Controller (PC)

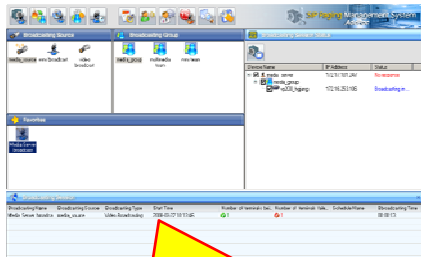

Recorded or uploaded sound file

General IP-PBX



Start Paging (HTTP)

Paging Group Number 9000



SIP Paging Server

sound file

Send RTP simultaneously



AP1602



AP1602

INVITE

200 OK

Broadcasting (RTP)

INVITE

200 OK

Broadcasting (RTP)

Audio Paging by HTTP API

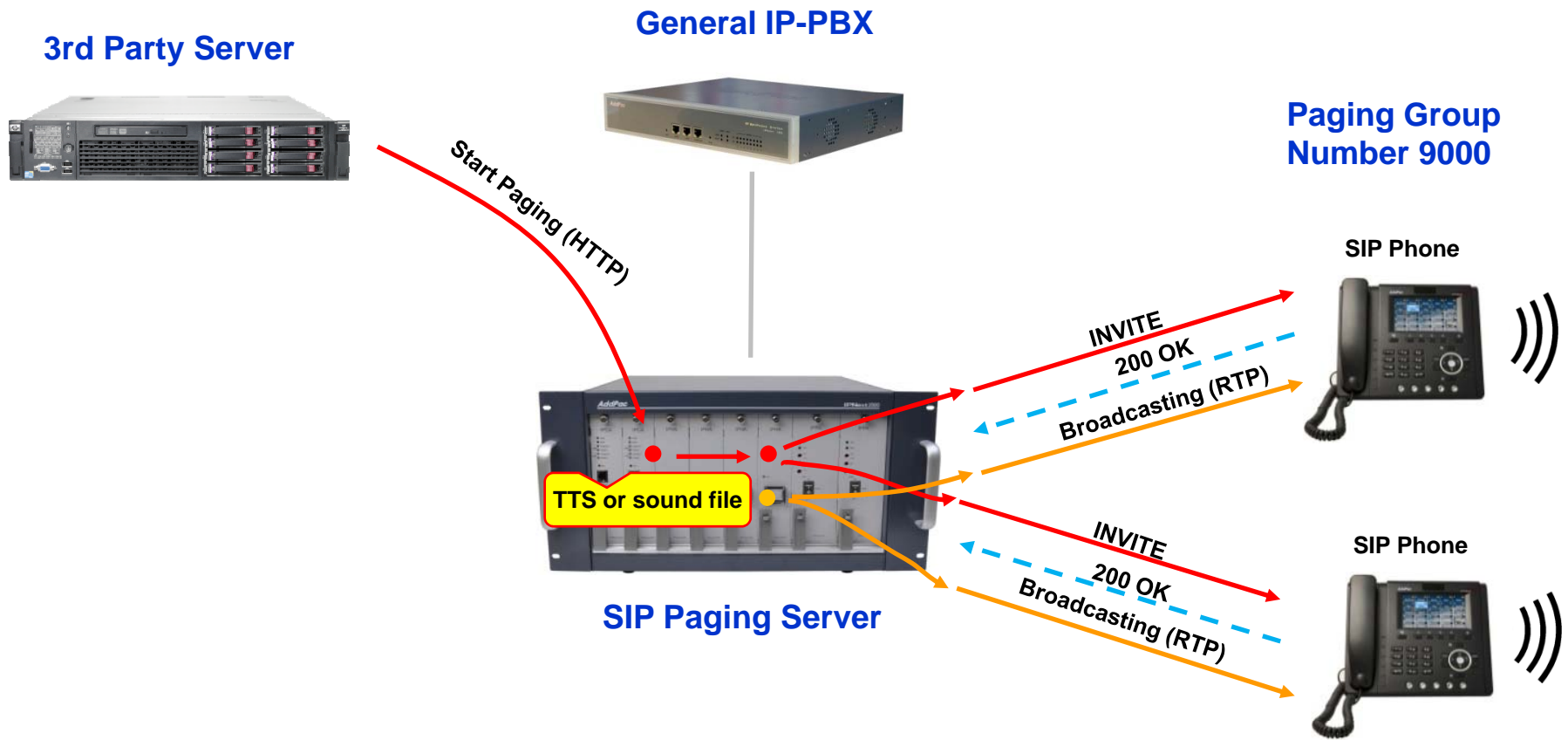

SMS Paging by HTTP API

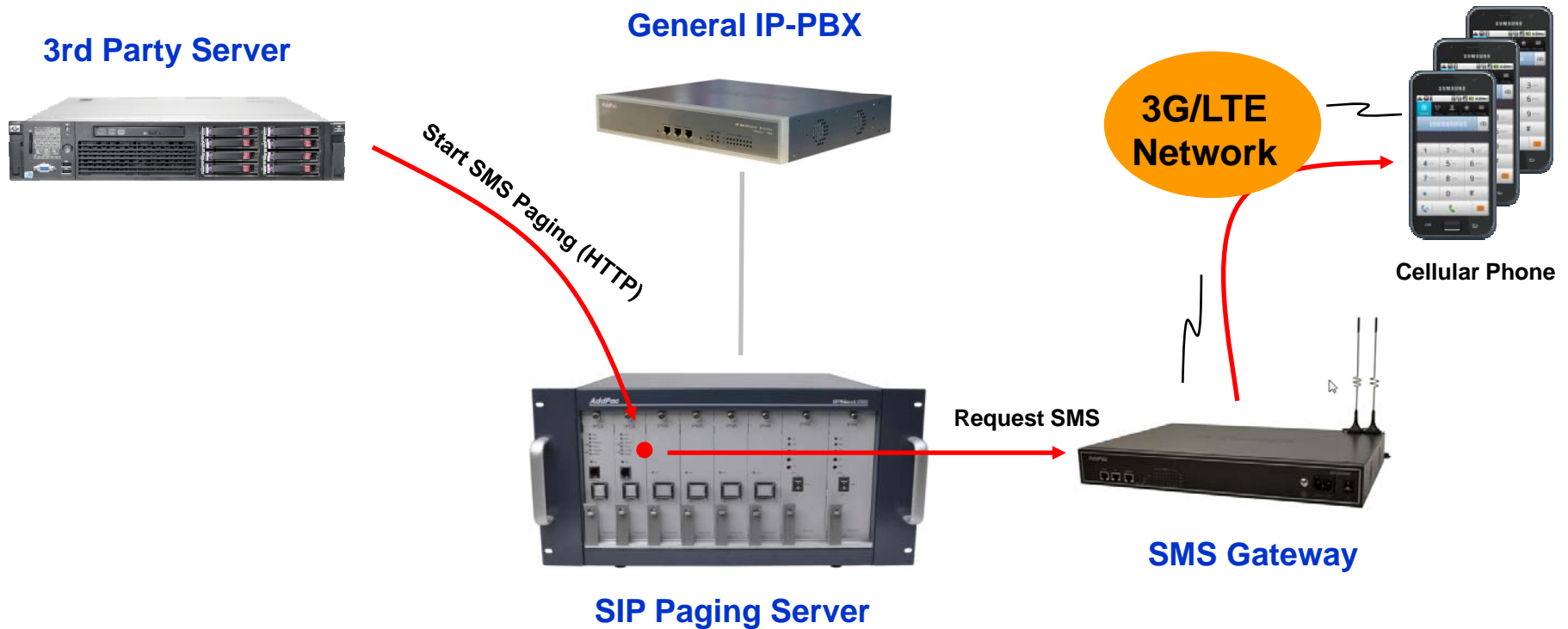

Scheduled Paging

Web Controller (PC)

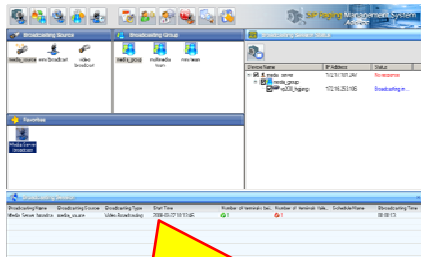

Make a schedule

General IP-PBX



Add a Schedule (HTTP)



SIP Paging Server

Paging Group Number 9000



AP1602

INVITE

200 OK

Broadcasting (RTP)

INVITE

200 OK

Broadcasting (RTP)



AP1602



SIP Paging Management Software (SPMS)

SIP Paging Management System GUI Initial Screen

The screenshot displays the SIP Paging Management System GUI. The interface is divided into several sections:

- Broadcasting Source:** Contains icons for 'media_source', 'nms broadcast', and 'video broadcast'. A yellow callout box labeled 'Paging source' is overlaid on this section.
- Broadcasting Group:** Contains icons for 'media_group', 'multimedia team', and 'nms team'. A yellow callout box labeled 'Paging Groups' is overlaid on this section.
- Broadcasting Session Status:** A table with columns 'Device Name', 'IP Address', and 'Status'. It lists 'media_server' (172.17.101.247, No response), 'media_group' (172.16.253.106, Broadcasting in ...), and 'vp200_hgjiang' (172.16.253.106, Broadcasting in ...). A yellow callout box labeled 'Paging Organizer' is overlaid on this section.
- Favorites:** Contains a 'Media Server broadcast' icon. A yellow callout box labeled 'Favorite Paging Group with Source' is overlaid on this section.
- Broadcasting Session:** A table with columns: Broadcasting Name, Broadcasting Source, Broadcasting Type, Start Time, Number of terminals bei..., Number of terminals fail..., Schedule Name, and Bbroadcasting Time. It shows one active session: 'Media Server broadca...' using 'media_source' for 'Video Broadcasting' starting at '2008-03-27 10:13:46' with 1 terminal being successful and 1 failing. A yellow callout box labeled 'Active Paging Sessions' is overlaid on this section.

Paging Device Management

The screenshot displays the SIP Paging Management System AddPac interface. At the top, there is a toolbar with various icons and a title bar that reads "SIP Paging Management System AddPac". Below the toolbar, there is a "Broadcasting Device Management" section with a table of devices. A "Device Properties" dialog box is open, showing details for a device named "media_server".

Device Name	IP Address	Device Model
172.16.41.11	172.16.41.11	AP-VP300
media_server	172.17.101.247	AP3120
NMS_VP300	172.16.16.30	AP-VP300
phone_schoi	172.16.19.101	AP-VP300
landberg	172.16.19.100	AP3120
vp200_hgiang	172.16.253.106	AP-VP300
vp200_meeting_room	172.17.201.108	AP-VP300
VP200_phkwon	172.16.40.30	AP-VP300

The "Device Properties" dialog box shows the following fields:

- Device Name: media_server
- Description: (empty)
- IP Address: 172.17.101.247
- Device Model: AP3120
- Remote control of Broadcasting: (empty)

Below the dialog box, there is a "Broadcasting Session" section with a table showing session details:

Broadcasting Name	Broadcasting Source	Broadcasting Type	Start Time	Number of terminals bei...	Number of terminals faile...	Schedule Name	Broadcasting Time
Media Server broadca...	media_source	Video Broadcasting	2008-03-27 10:13:46	1	1		00:03:09

Paging Group Management

The screenshot displays the 'SIP Paging Management System AddPac' software interface. The main window is titled 'Group Properties' and contains the following elements:

- Group Name:** A text field containing 'nms_team'.
- Description:** An empty text field.
- Setup for Amplifier:** A section with three checkboxes: 'Amplifier 1', 'Amplifier 2', and 'Amplifier 3', all of which are currently unchecked.
- Buttons:** 'Add Device' and 'Add Group' buttons are located above the device lists.
- Broadcasting Device List:** A table listing available devices with columns for Device Name, IP Address, Module, and Port Number.
- Broadcasting device included in the group:** A table showing devices currently assigned to the group, with columns for Device Name, IP Address, and Port Number.
- Navigation:** Arrow buttons are positioned between the two tables to facilitate moving devices between them.
- Footer:** 'Ok' and 'Cancel' buttons are located at the bottom of the dialog.

Broadcasting Device List			
Device Name	IP Address	Module	Port Number
landberg	172.16.19.100	AP-AV1000	(1/1) (1/0)
media_server	172.17.101.247	AP-AUDIO2	(1/0) (1/0)
media_server	172.17.101.247	AP-AUDIO2	(1/1) (1/1)
172.16.41.11	172.16.41.11	AP-VP300	(0/1) (0/0)
NMS_VP300	172.16.16.30	AP-VP300	(0/1) (0/0)
vp200_meeting_ro...	172.17.201.108	AP-VP300	(0/1) (0/0)
vp200_hgyang	172.16.253.106	AP-VP300	(0/1) (0/0)
phone_jschol	172.16.19.101	AP-VP300	(0/1) (0/0)
VP200_phkwon	172.16.40.30	AP-VP300	(0/1) (0/0)

Broadcasting device included in the group		
Device Name	IP Address	Port Number
172.16.41.11	172.16.41.11	(0/1) (0/0)

Administrator Management

The screenshot shows the 'Admin Properties' dialog box in the SIP Paging Management System. The dialog has two tabs: 'Admin Management' and 'Permitting Admin Access Management'. The 'Admin Management' tab is active and displays a table of administrators.

Admin	Name	Description	Connect Status
	root	administrator	127.0.0.1

To the right of the table is a form for adding or modifying an administrator:

- Admin ID:
- Password:
- Admin Name:
- Description:
- Access Authority:
- Number of Maximum Acc:

Buttons: Add, Modify, Delete, Save

The background application window shows a dashboard with icons for Broadcasting Source, Broadcasting Group, and Broadcasting structure. A 'Favorites' section contains 'Media Server broadcast'. At the bottom, a table lists broadcasting schedules with columns: Broadcasting Name, Broadcasting Source, Broadcasting Type, Start Time, Number of terminals bei..., Number of terminals fails..., Schedule Name, and Bbroadcasting Time.

Scheduled Paging Management

The screenshot displays the 'SIP Paging Management System AddPac' software interface. A 'Schedule Properties' dialog box is open, allowing configuration for a scheduled broadcast. The dialog includes fields for 'Selecting Broadcasting' (set to 'Media Server broadcast'), 'Schedule Name', and 'Description'. It also features radio buttons for 'Scheduled Broadcasting' (General selected) and 'Scheduling Method' (Day selected). A 'Select Day' section contains checkboxes for days of the week. The 'Broadcasting Time' section includes 'Start Time' and 'End Time' fields, both set to 3/27/2008 at 10:22:16. An 'Audio File' field with a 'Select' button is also present. The background shows a main window with a table of schedules and a 'Broadcasting Session' table at the bottom.

Schedule Name	Broadcasting ...	Start Time
Morning Broadcasting	General	10:21:27

Broadcasting Name	Broadcasting Source	Broadcasting Type
Media Server broadca...	media_source	Video Broadcasti...

TTS Paging

The screenshot displays the SIP Paging Management System interface. A central dialog box titled "TTS Broadcasting" is open, showing a "Favorites Name" dropdown set to "Media Server broadcast". The dialog has two tabs: "TTS" (selected) and "TTS List". The "TTS" tab contains a text area with the following text:

WASHINGTON (AFP) - The Pentagon on Wednesday said an eruption of violence in southern Iraq, where US-backed government forces were battling Shiite militias, was a "by-product of the success of the surge."

Pentagon press secretary Geoff Morrell said it showed that the Iraqi government and security forces were now confident enough to take the initiative against Shiite extremists in the southern part of Basra.

Below the text area is an "Audio File Name" input field and a "Start" button. A "Close" button is located at the bottom right of the dialog.

The background interface includes a top toolbar with various icons, a "Broadcasting Source" section with "media_source", "nms broadcast", and "video broadcast" options, a "Favorites" section with "Media Server broadcast", and a "Broadcasting Session" table. The table has columns for "Broadcasting Name", "Broadcasting Source", and "Bro...".

IP Address	Status
nms team 172.16.41.11	

Broadcasting Name	Broadcasting Source	Bro...

Ordering Information

- **AP-SPS2000 SIP Paging Server**
 - AP-SPS2000 SIP Paging Server Main Body
 - High-performance 64bit RISC CPU
 - High-End 64bit CPU board (Hot-Swap)
 - 2-ports Fast Ethernet and 1-port RS-232C Console
 - Including Network Cable Set & Ext. Power Supply, etc.
 - Power Supply Module (Hot-Swap)
 - Additional CPU board for Fault Tolerant (option)
 - Additional Power Supply Module for Redundancy (option)
- **Built-in APOS Internetworking Software for AP-SPS2000**
- **Including 1 Year Hardware Warranty**
- **Product Documents**
 - Install and Operation Guide (PDF)
- **Pricing**
 - AddPac Technology Regional Sales Manager
 - Authorized Sales and Marketing Representatives
 - Please Contact www.addpac.com



Thank you!

AddPac Technology Co., Ltd.
Sales and Marketing

Phone +82.2.568.3848 (KOREA)

FAX +82.2.568.3847 (KOREA)

E-mail sales@addpac.com