

AP-SWP80

Sensor Control Wall PAD

High Performance IoT Wall PAD Solution for ZigBee/Zwave Sensor Control

Preliminary Product Overview

(Without notice, following described technical spec. can be changed)

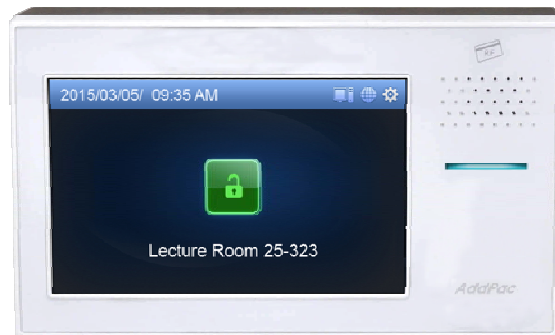

AddPac

AddPac Technology

Sales and Marketing

www.addpac.com

Contents

- Product Overview
- Product Highlights
- Hardware Specification
- Software Service
- Network Protocols
- Network Management
- Security Management
- Application Area
- Ordering Information

Product Overview

AP-SWP80 Sensor Control Wall PAD

- High Performance Sensor Control Wall PAD Solution for ZigBee/Zwave Sensor Devices
- Advanced Enterprise Sensor Device Control Solution
- Interworking with AddPac Smart Sensor Network Controller
- TFT Color LCD, Touch Screen, Internal MIC & Speaker
- High Quality “5 Inch LCD, 800x480 Video Resolution
- Network Interface
 - One(1) 10/100Mbps Fast Ethernet
- PoE(Power over Ethernet) or External Power Supply Adaptor
- Powerful Network Protocols (PPPoE, DHCP, Static Routing, etc)
- Firmware Upgradeable Architecture

Product Highlights

AP-SWP80 Sensor Control Wall PAD

Powerful Wall PAD Solution for Sensor Device Control

IP based Smart Sensor Control Wall PAD

RF Card Interface Support

Touch Screen LCD

High Performance RISC CPU & Programmable DSP

5 Inch LCD Display
800 x 480 Resolution

Interworking Service with Smart Hub

APOS™ Technology
Multimedia Network Protocol

Interworking with Smart Sensor Network Controller

IP based Network Protocol

Broadband IP Networking
with one 10/100Mbps fast ethernet

Firmware Upgradable
Architecture

www.addpac.com

AddPac

Multimedia Service

AP-SWP80 Sensor Control Wall PAD

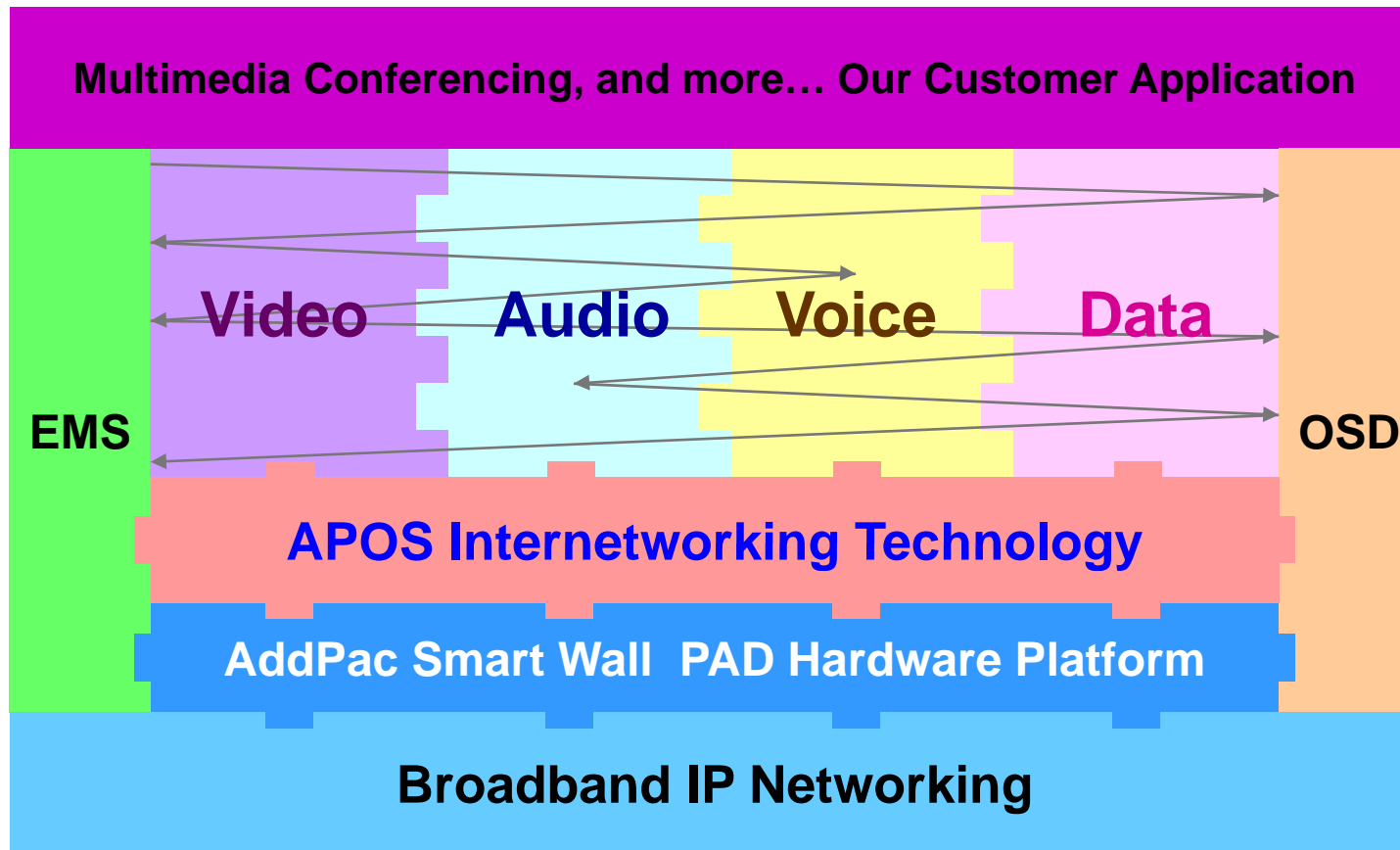

- APOS : AddPac Internetworking Operating System
- OSD : On- Screen Display
- EMS : Element Management System

Hardware Specification

AP-SWP80 Sensor Control Wall PAD

- RISC+DSP Microprocessor Computing Power
- Audio and Voice Interface
 - Internal MIC
 - Internal Speaker
- TFT Color LCD Interface with Touch Screen
 - 5 Inch LCD, 800 x 480 Video Resolution
- RF Card Interface with LED Lamp Indication
- Network Interface
 - One(1) 10/100Mbps Fast Ethernet
- Wall Mount
- Power Supply
 - Power over Ethernet (Option)
 - External Power Adaptor (Default)

Hardware Specification

AP-SWP80 Sensor Control Wall PAD

- **LCD Controller**
 - One-Chip Solution for amorphous TFT-LCD
 - Support resolution up to 480xRGBx800
 - Built-in 172800 bytes internal RAM
 - 6,8,16, and 18-bit RGB Interface
 - Resize Function (x ½, x ¼)
 - On-Chip Power Management System
- **Speaker**
 - Impedance : 8 +-15%ohm at 1kHz, 1.0 Vrms
 - Sound Pressure : 90 +- 3dB at 0.1W/10 CM at 800Hz, 1.0kHz, 1.2kHz, 1.5kHz
 - Resonance Level : 550Hz +- 20%Hz at Fo Hz, 1.0Vrms
 - Frequency Range : Fo Hz ~20kHz
 - Input Power : Normal : 1.0 W, Max : 2.0W
- **Audio Amplifier**
 - 1-W BTL Output(5V, 0.11 % THD+N)
 - Uncompensated Gains of 2 to 20 (BTL Mode)
 - Thermal and Shot-circuit Protection
 - High Supply Ripple Rejection Ratio
- **PoE(Power over Ethernet), Option**
 - IEEE802.3af compliant
 - Input voltage range 36V to 57V
 - Short-circuit Protection

Hardware Specification

AP-SWP100 Sensor Control Wall PAD

Front Side

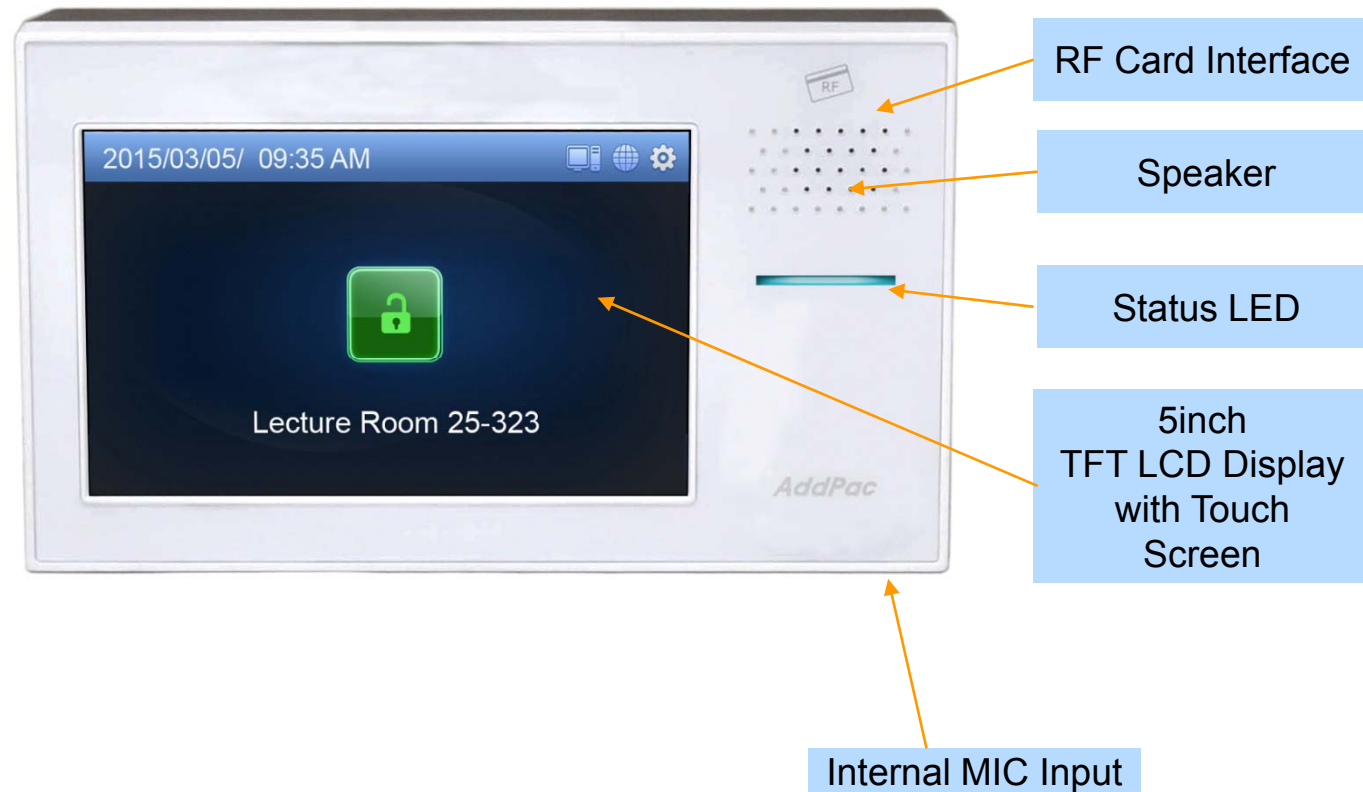

Hardware Specification

AP-SWP80 Sensor Control Wall PAD

Back Side

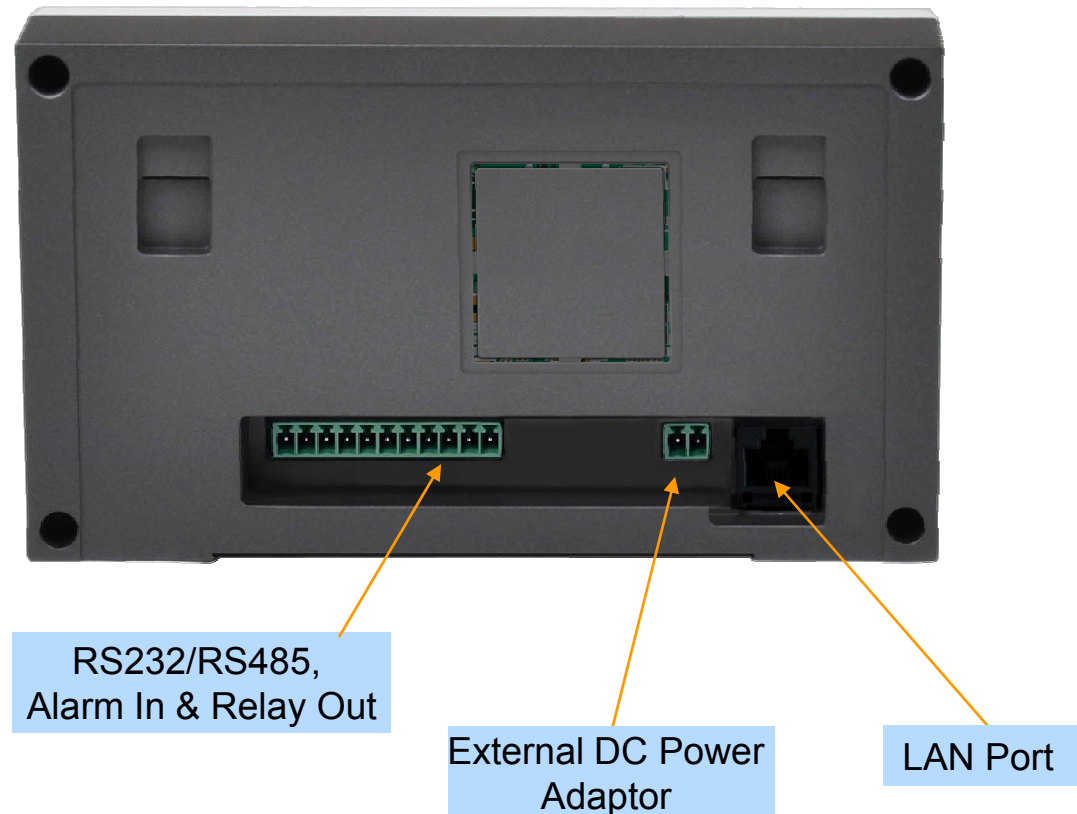

Software Service

AP-SWP80 Sensor Control Wall PAD

- Built-in AddPac APOS Internetworking Software
 - Scalability, Functionality, and Stability Features
 - IP Sensor Control Wall PAD Function for Z-Sensor Devices
- Firmware Upgradeable DSP Architecture
- OSD (On-screen Display) Function Support
- Industry Standard IP based Network Protocol Features

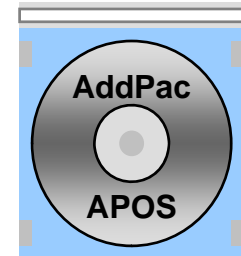

Network Protocols

AP-SWP80 Sensor Control Wall PAD

Basic Network Protocols

- ARP, IPv4, TCP, UDP, ICMP, SCTP, IGMP, MLD

Routing Protocol

- IPv4 : Static

Service Protocol

- FTP, Telnet, TFTP, DHCP Server/Relay, SNMP Server
- CDP (Cisco Discovery Protocol)
- DNS Resolver , DDNS(nsupdate)
- Bridge
- Syslog

IPv4 Address Configuration

- Fixed (Static)
- DHCP
- PPPoE

Miscellaneous

- Standard & Extended IPv4 Access List
- Multi-level User Account Management
- IP accounting
- STUN Client

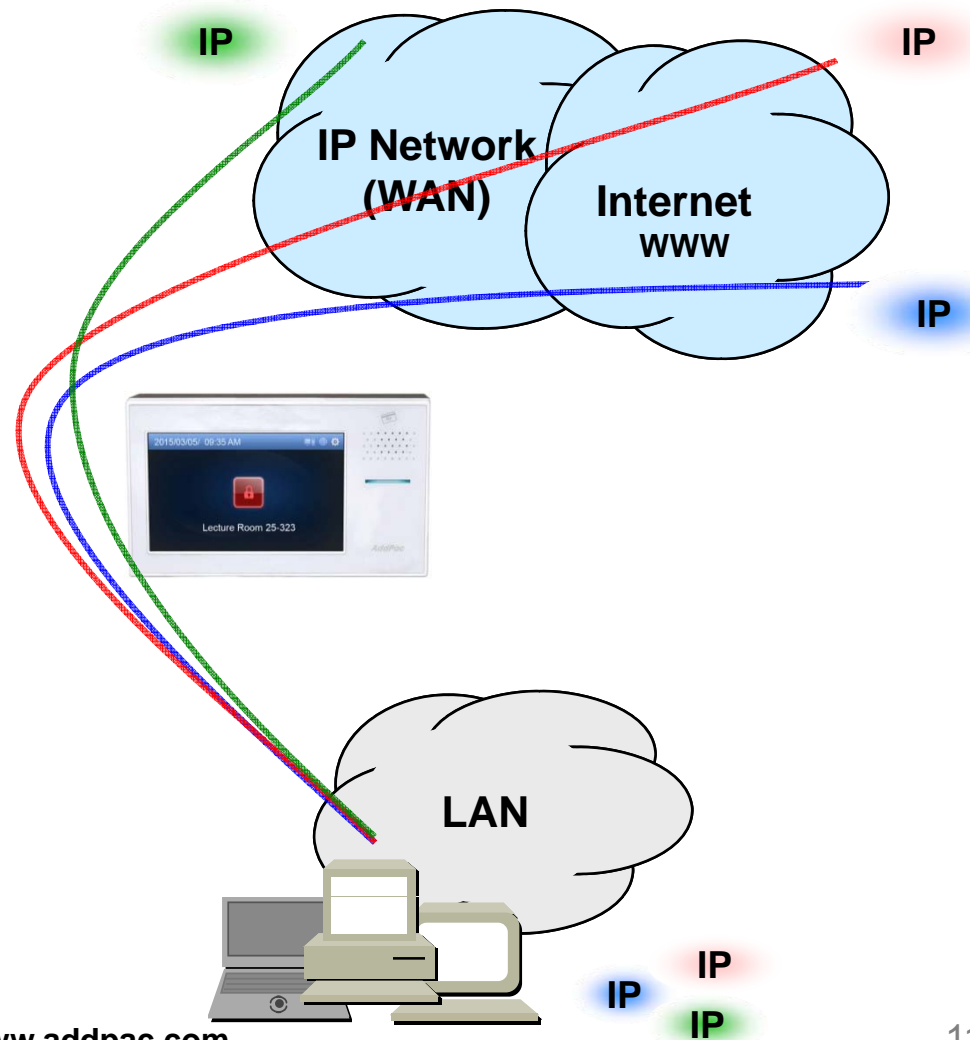

Network Management

AP-SWP80 Sensor Control Wall PAD

- **SNMP**

- Standard Simple Network Management Protocol(SNMP) Agent support
- MIB v1 and v2 Support

- **Web-based Management**

- Smart Easy Setup
- Standard Voice Interface
- Standard PSTN Back-up Interface

- **Watch-dog Function**

- Hardware, Software watch-dog services

- **Remote Management**

- Telnet
- Rlogin

- **Auto Upgrade Service**

- HTTP server based APOS image and configuration file auto-upgrade support

- **Batch Job Function**

- Text based script downloading

- **Interoperable with AP-SNMS Service**

- AddPac Smart Network Management System

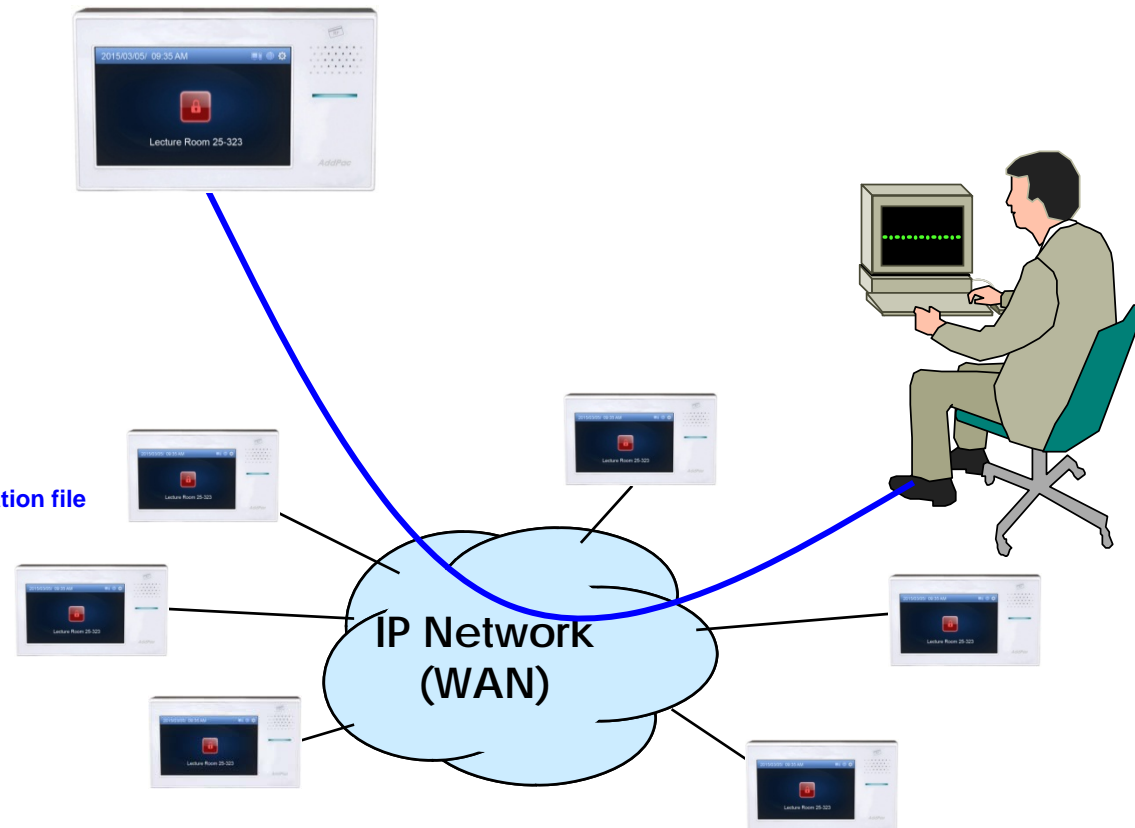

Security Management

AP-SWP80 Sensor Control Wall PAD

- IP packet filtering
- IP access list
- User authentication function
 - Password Authentication Protocol (PAP)
 - Challenge Handshake Authentication Protocol (CHAP)
- Enable/Disable specific protocols
- Auto-square connect of Telnet session
- Account Management function for multi-level user
- SNMP/TELNET/FTP/HTTP/TFTP port assignment function
- SNMP/TELNET/FTP access list management
- Boot mode security checking function

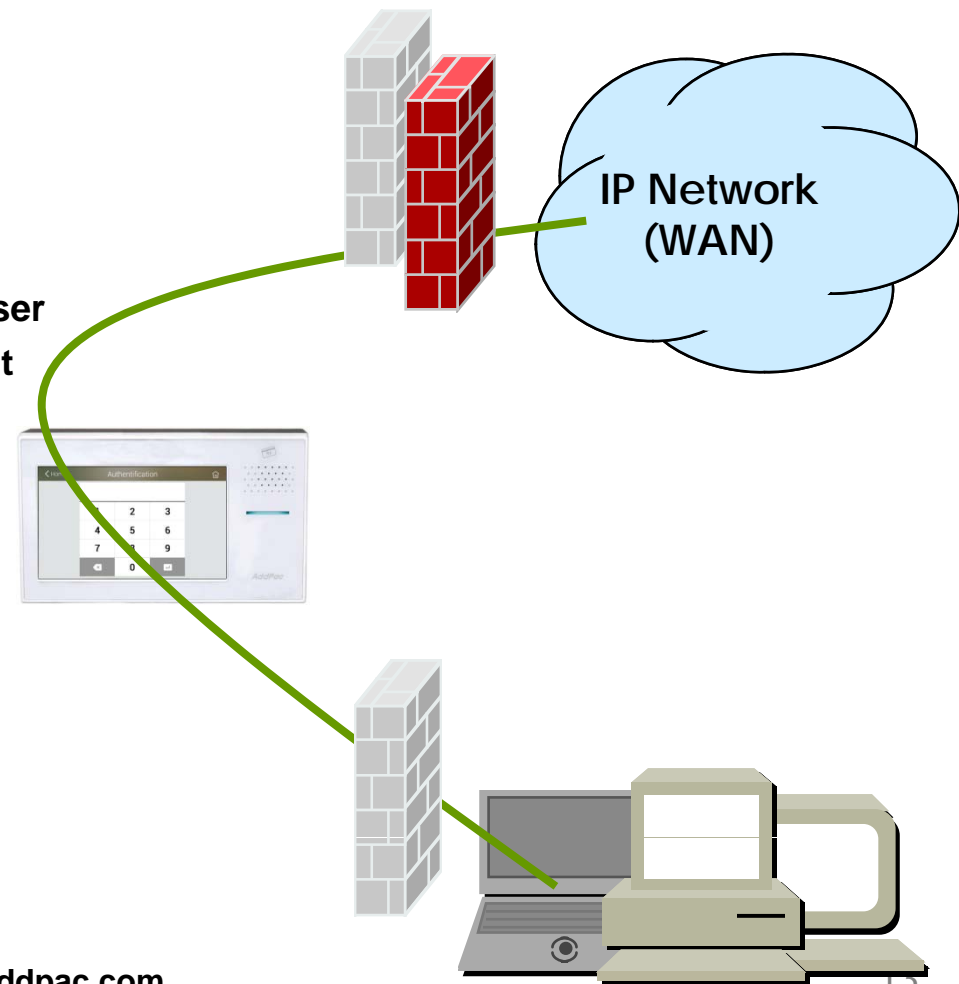

AP-SWP80 IP Sensor Control Wall PAD for Z Sensors : Standard Application

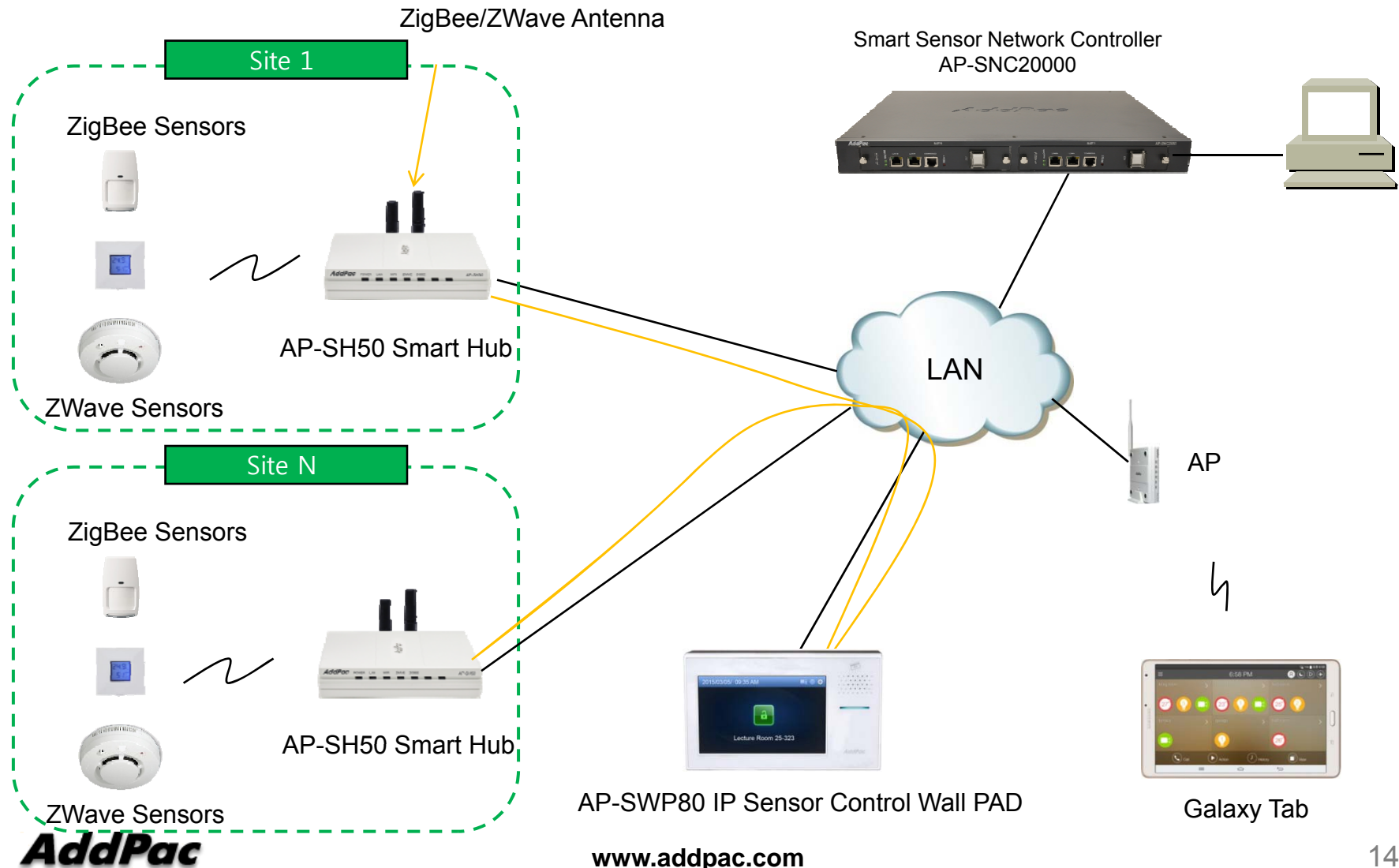

AP-SWP80 Smart Hub Control PAD for Z Sensors : Large Scale Application

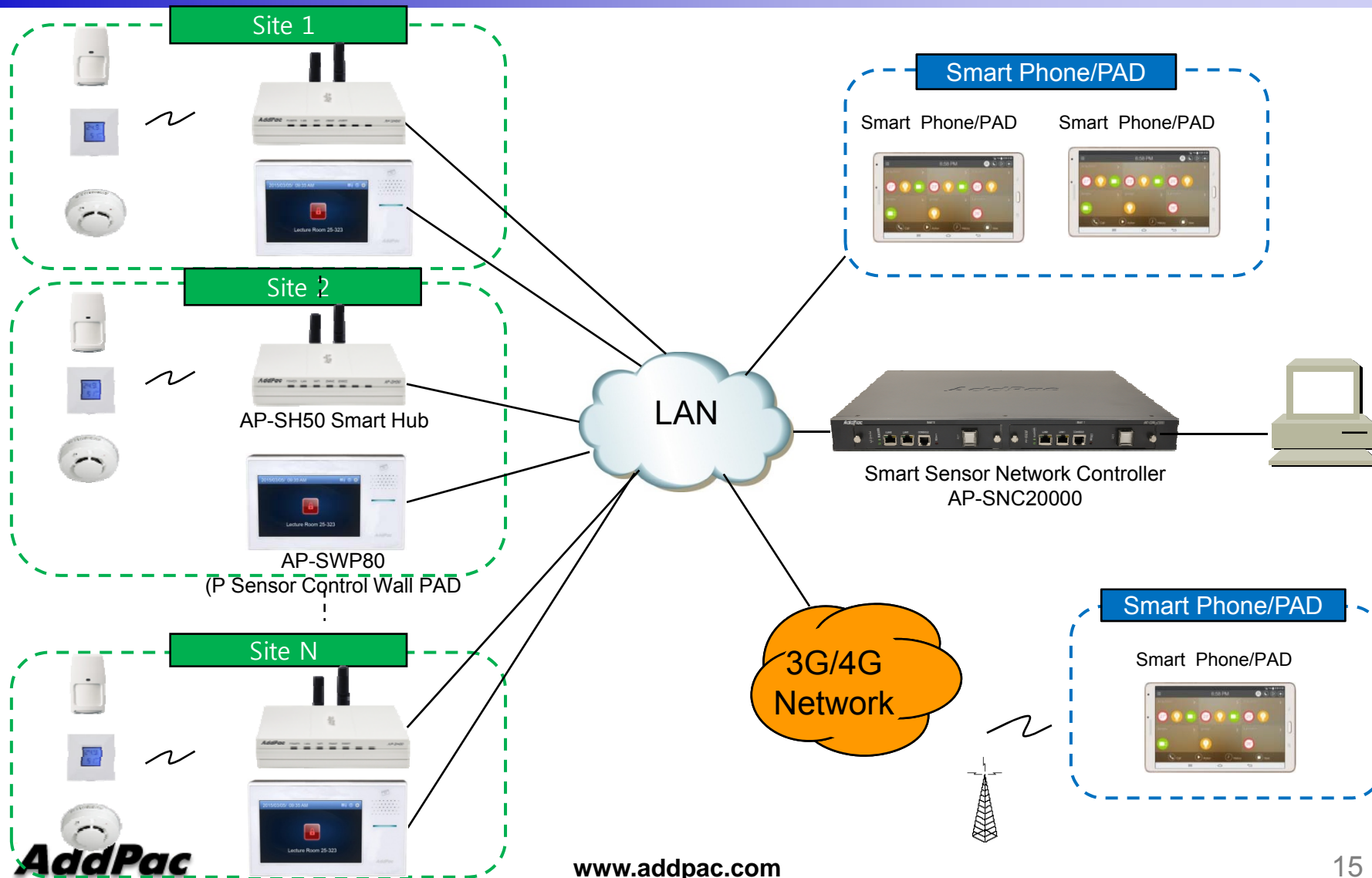

Ordering Information

- **AP-SWP80 IP Sensor Control Wall PAD Hardware**
 - AP-SWP80 IP Sensor Control Wall PAD Main Body
 - RISC Microprocessor with High-end Programmable DSP Architecture
 - 5 Inch LCD with Touch Screen Features
 - Internal MIC, Internal Speaker
 - RF Card Interface
 - 1-Port 10/100Mbps Fast Ethernet
 - PoE Interface (Option)
 - Including Network Cable Set & External Power Supply, etc.
- **Built-in APOS Internetworking Software for AP-SWP80**
- **Including 1 Year Hardware Warranty**
- **Product Documents**
 - Install and Operation Guide (PDF)
- **Pricing**
 - AddPac Technology Regional Sales Manager
 - Authorized Sales and Marketing Representatives
 - Please Contact www.addpac.com



Thank you!

AddPac Technology Co., Ltd.
Sales and Marketing

Phone +82.2.568.3848 (KOREA)

FAX +82.2.568.3847 (KOREA)

E-mail sales@addpac.com