

IP Video Door Phone Recording Solution

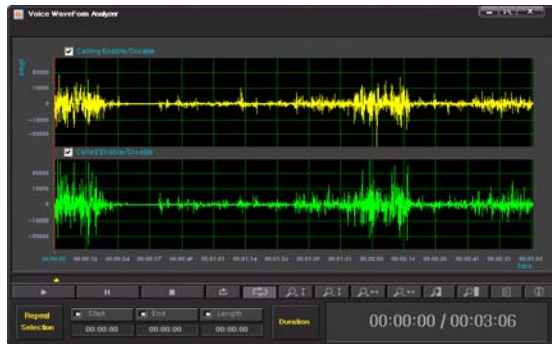

AddPac

AddPac Technology

Sales and Marketing

Contents

- Network Diagram
- Product Specifications
 - IP Video Door Phone Recording Servers
 - IP Video Phone with Voice/Video Recording Service Features
 - Smart Digital Video Door Phone Recording Management Program

Network Diagram

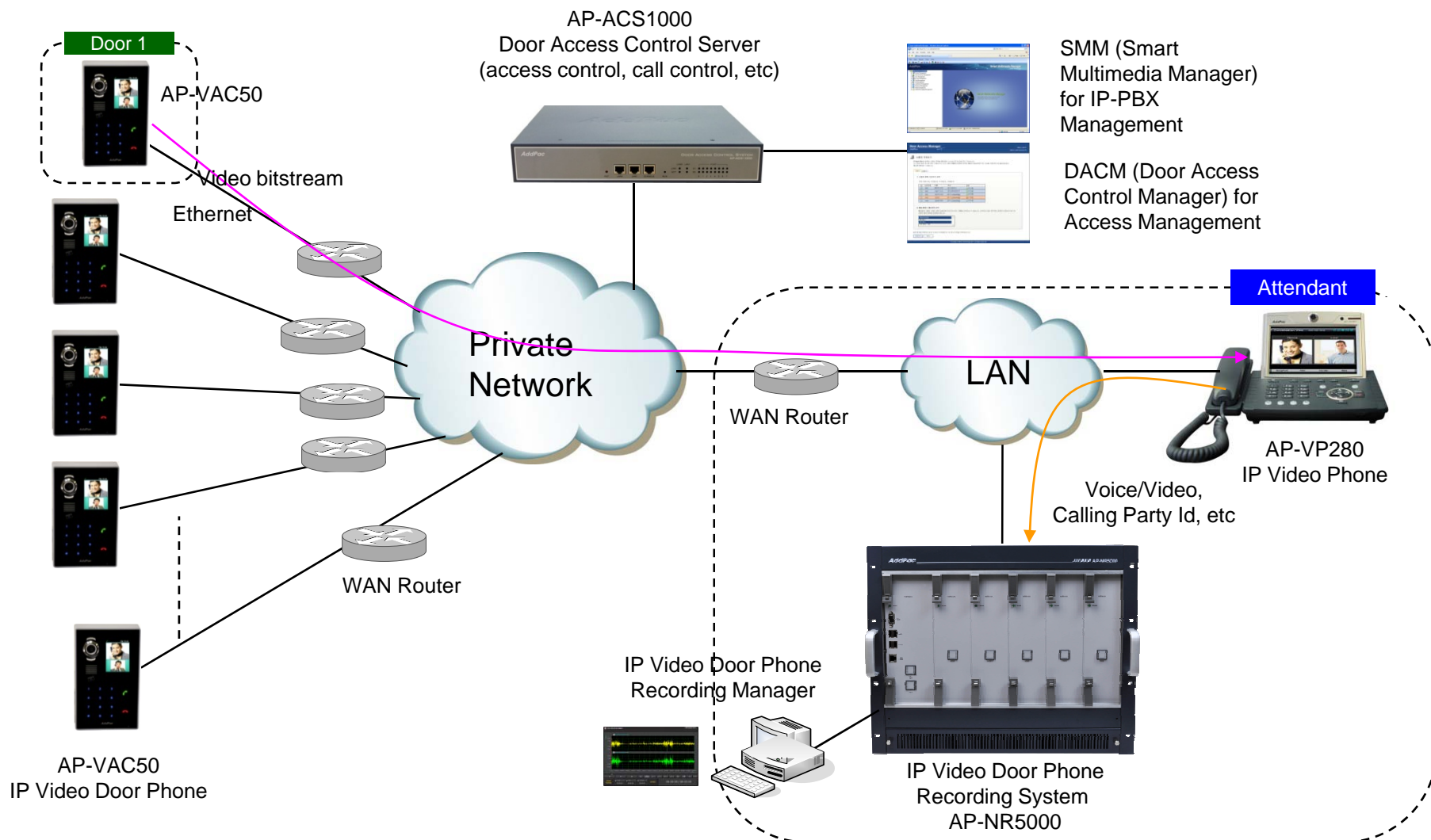



IP Video Door Phone Recording Server AP-NR5000

Product Overview

AP-NR5000 IP Video Door Phone Recording Server

- IP based Video Door Phone Recording Server
- Linux Operating System
- Powerful Management and User Friendly Features
- High-performance Voice/Video Recording Service
- External IP Video Phone (AP-VP280, etc) Interworking Support
- Firmware Upgradeable Architecture
- One(1) 10/100/1000Mbps Gigabit Ethernet Interface
- Up to Five(5) 3.5Inch SATA Hard Disk Interface Support
- USB Interface Support

Hardware Specification

AP-N5000 IP Video Door Phone Recording Server

- High Performance Computing Power
- Main Processor Board
 - Network Interface
 - One(1) 10/100/1000Mbps Gigabit Ethernet
 - Video Output Interface
 - RGB Video Output
 - USB 2.0 Interfaces for Mouse, Keyboard, etc
- Hard Disk Board
 - Module Type Design
 - Up Five(5) Hard Disk Slots
 - 10~20 Tera HDD Capacity
- Power Supply
 - Dual Power Supply for Power Redundancy
 - Module Type Power Supply

Hardware Specification

AP-NR5000 IP Video Door Phone Recording Server

AP-NR5000 Front Side

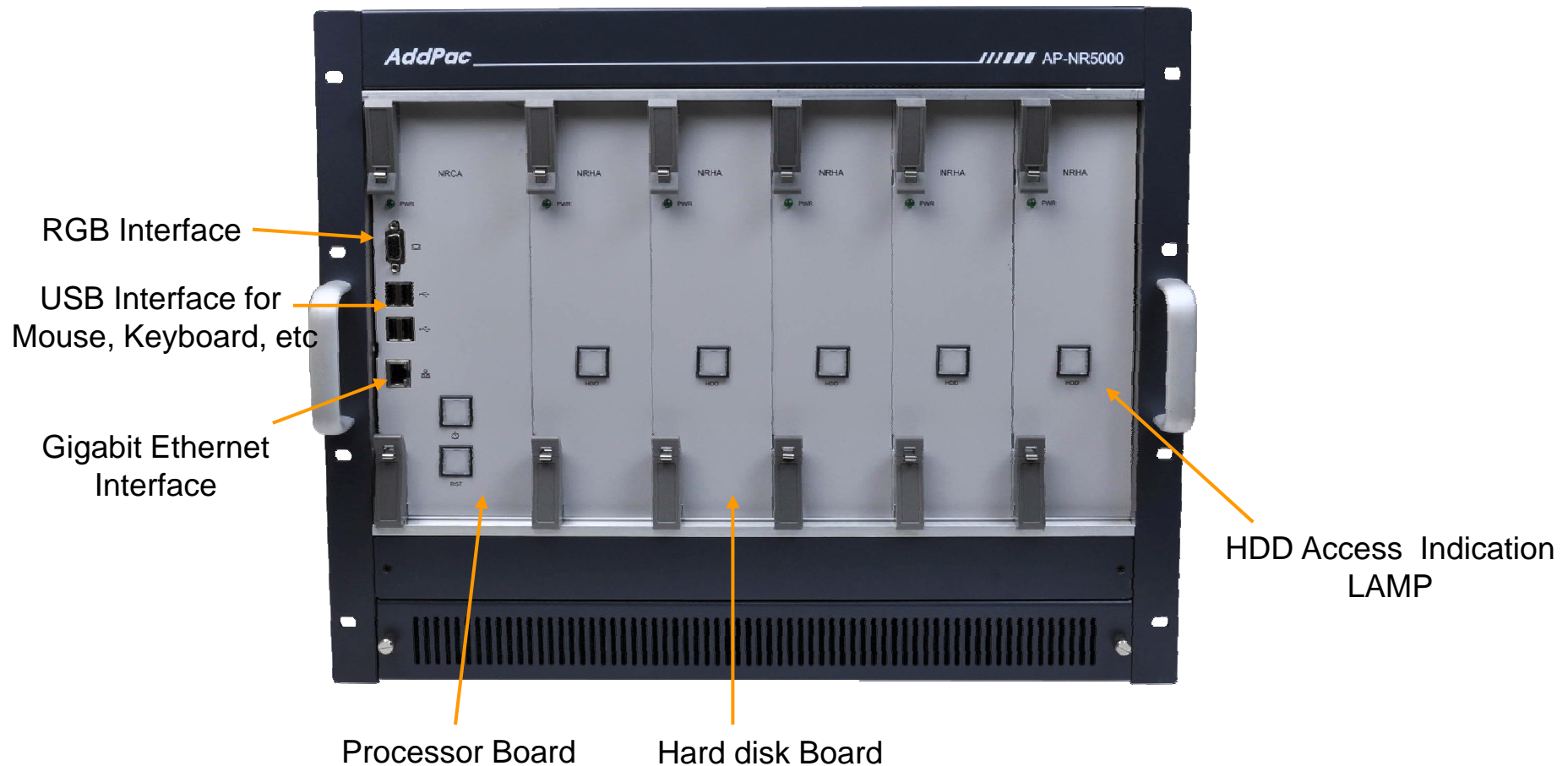

AddPac

www.addpac.com

Hardware Specification

AP-NR5000 IP Video Door Phone Recording Server

AP-NR5000 Back Side

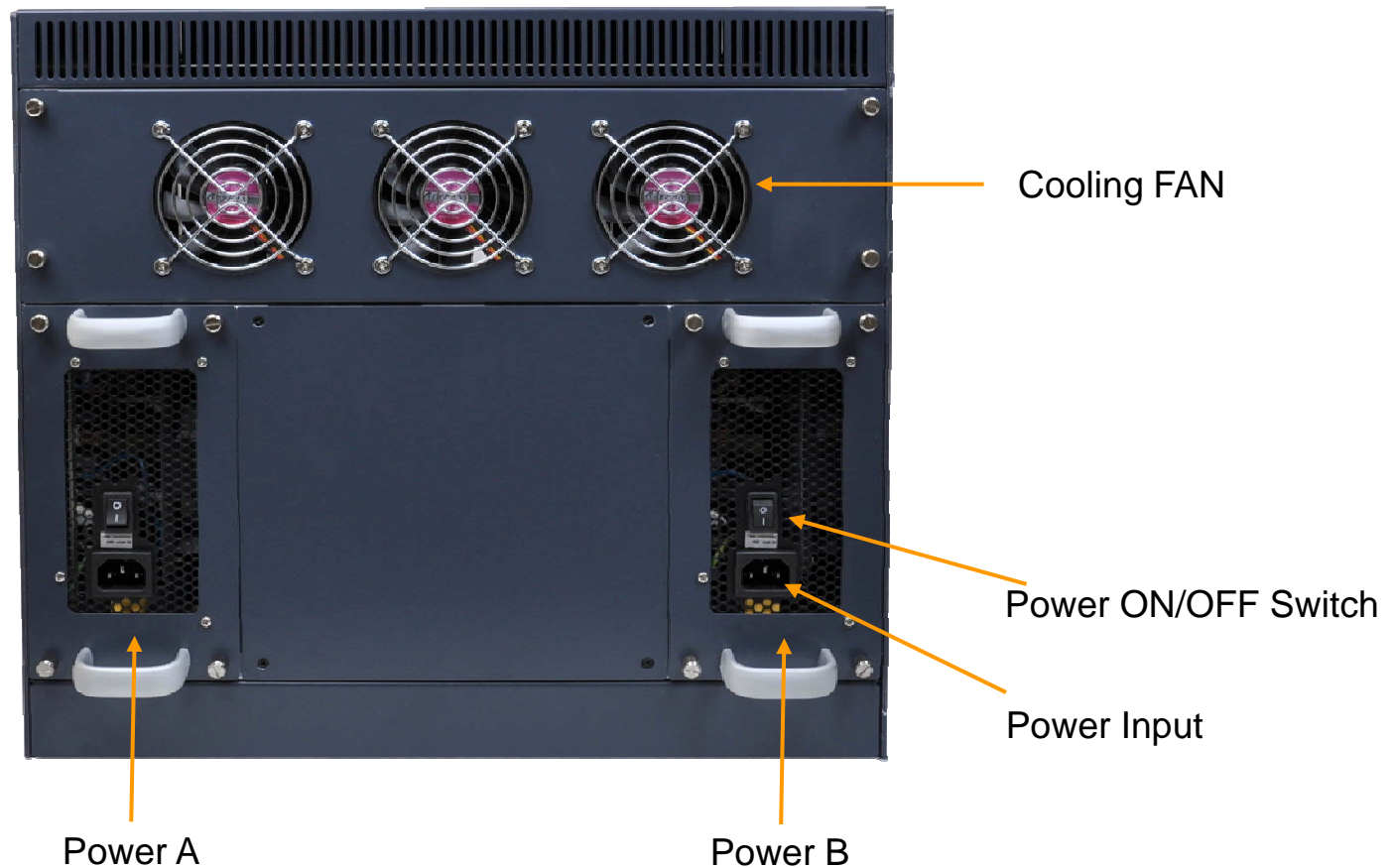



IP Video Door Phone Recording Server AP-NR3000

Product Overview

AP-NR3000 IP Video Door Phone Recording Server

- IP based Video Door Phone Recording Server
- Linux Operating System
- Powerful Management and User Friendly Features
- High-performance Voice/Video Recording Service
- External IP Video Phone (AP-VP280, etc) Interworking Support
- Firmware Upgradeable Architecture
- One(1) 10/100/1000Mbps Gigabit Ethernet Interface
- One(1) DVD Writer for Audio File Backup
- Up to Four(4) 3.5Inch SATA Hard Disk Interface Support
- USB Interface Support (Front Side, Back Side)

Hardware Specification

AP-N3000 IP Video Door Phone Recording Server

- High Performance Computing Power
- Main Chassis
 - Network Interface
 - One(1) 10/100/1000Mbps Fast Ethernet
 - Video Output Interface
 - HDMI, DVI,RGB Video Output
 - USB 2.0 Interfaces for Mouse, Keyboard, etc
 - One(1) DVD Writer for Video File Backup
 - Up to Four(4) Hard Disk

Hardware Specification

AP-NR3000 IP Video Door Phone Recording Server

AP-NR3000 Front Side

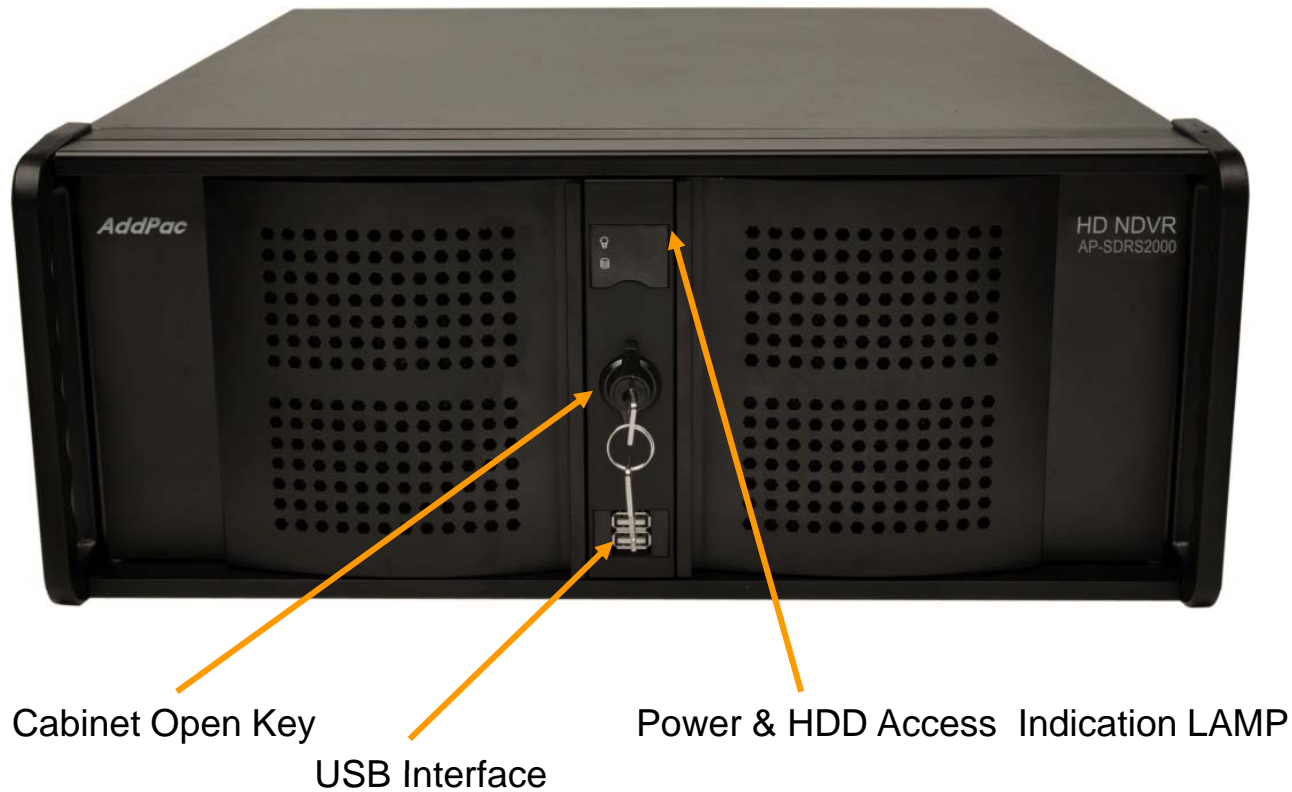

Hardware Specification

AP-NR3000 IP Video Door Phone Recording Server

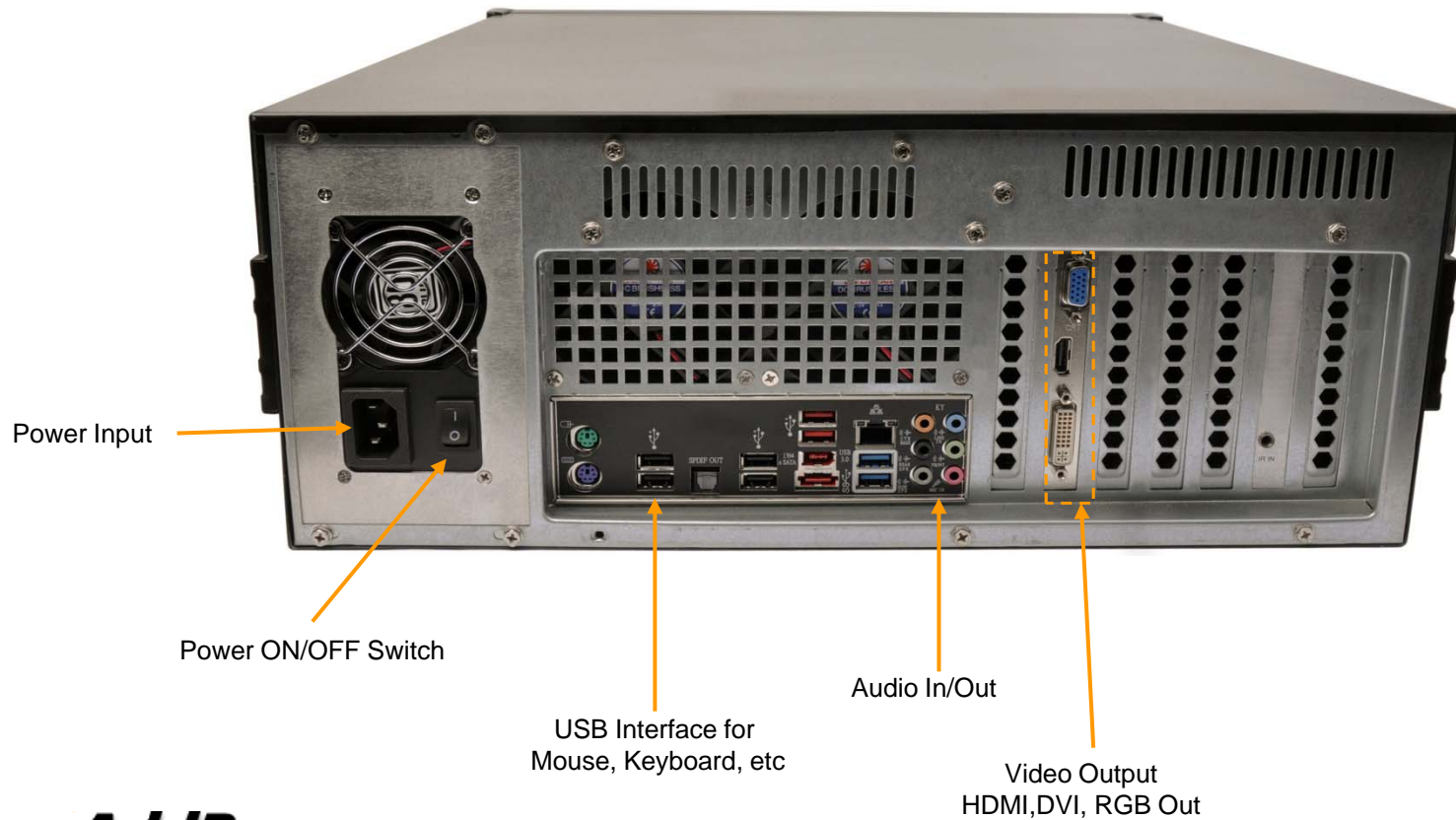

AP-NR3000 Back Side





IP Video Phones

IP Video Phones for AddPac IP Video Door Phone

Model	AP-VP280	AP-VP120
Spec.		
LCD Size	7Inch Touch Screen	4.3Inch
Camera	CMOS	CMOS
Video Codec	H.263 MPEG4 H.264	H.263 MPEG4 H.264
Signaling	H.323/SIP	H.323/SIP
Video MCU	N/A	N/A
Voice MCU	3-Party	3-Party
LAN Port	2	2
PoE	Support	Support

Network Diagram for Video Door Phone Recording

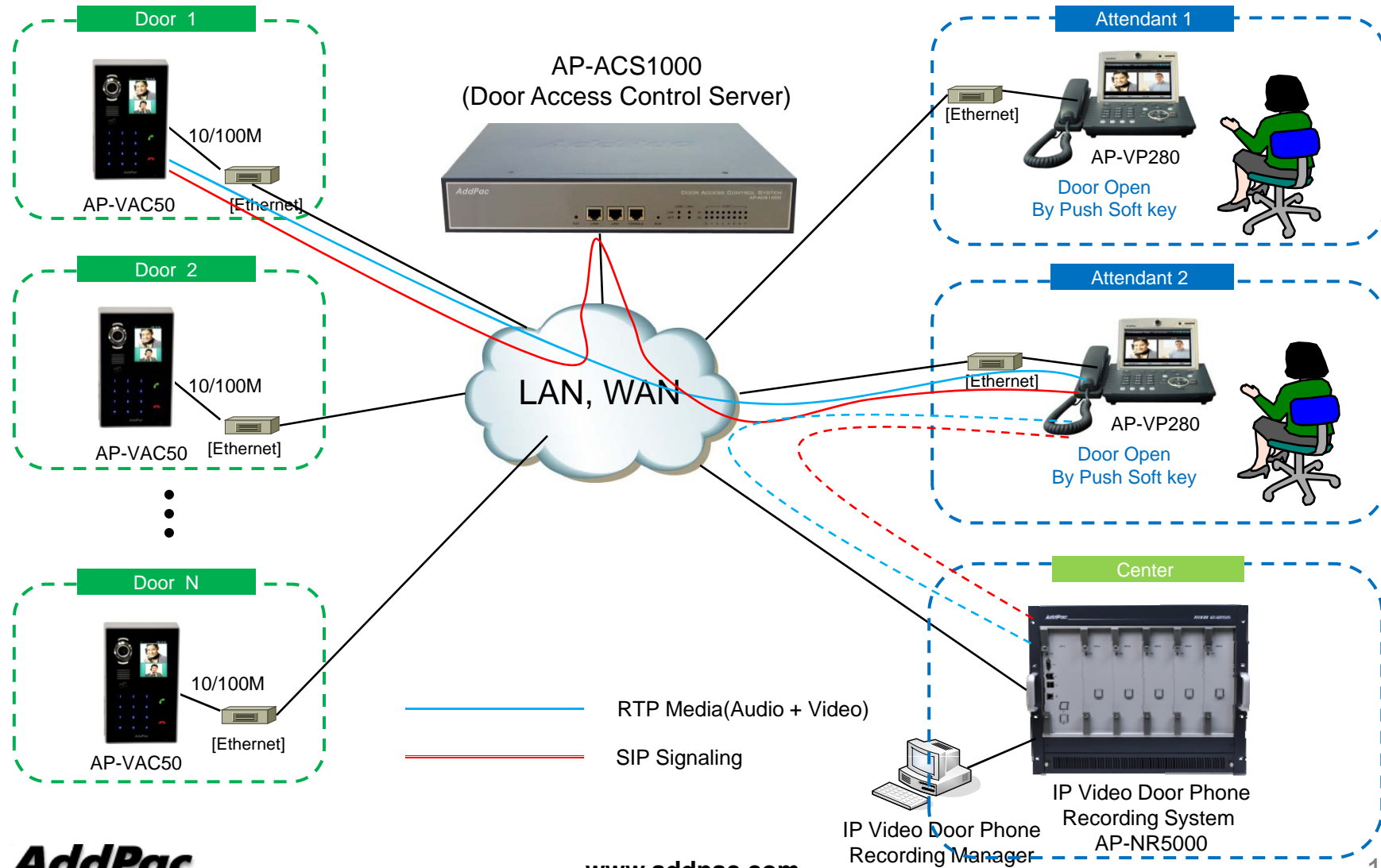

SIP Video Call Flow

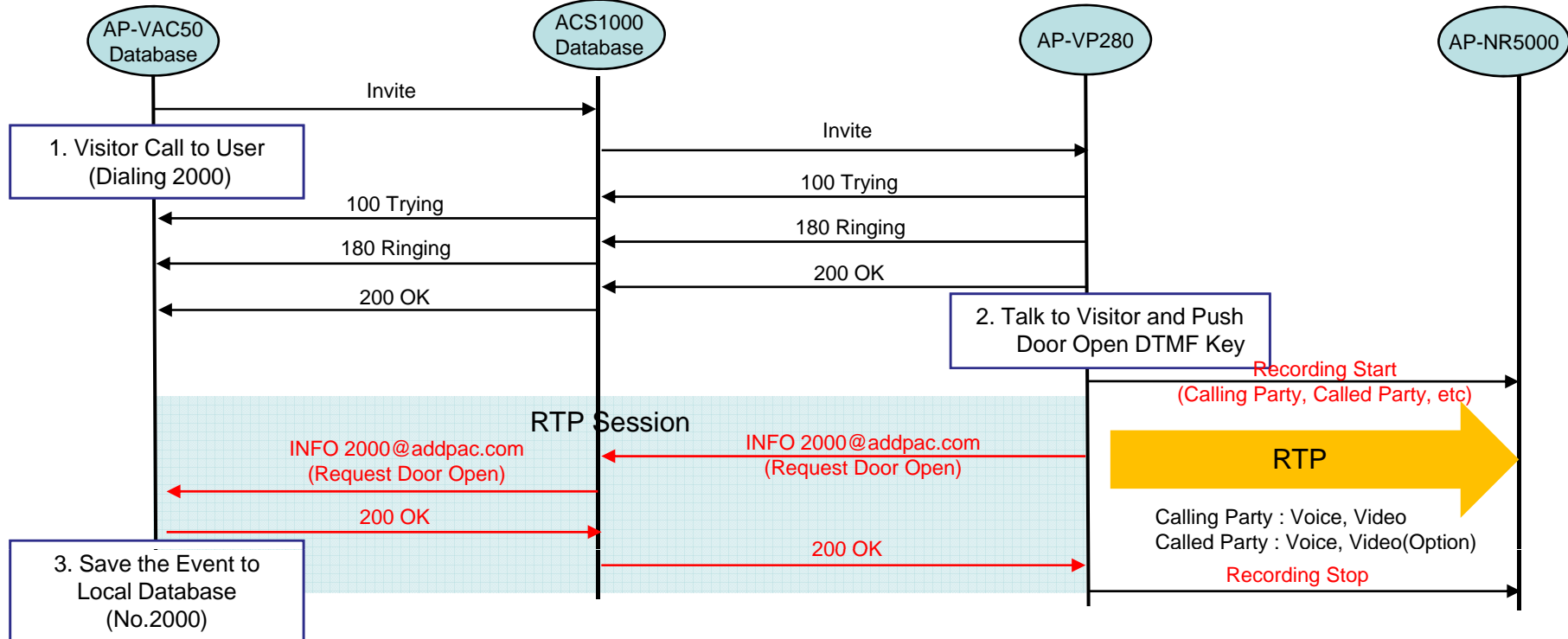
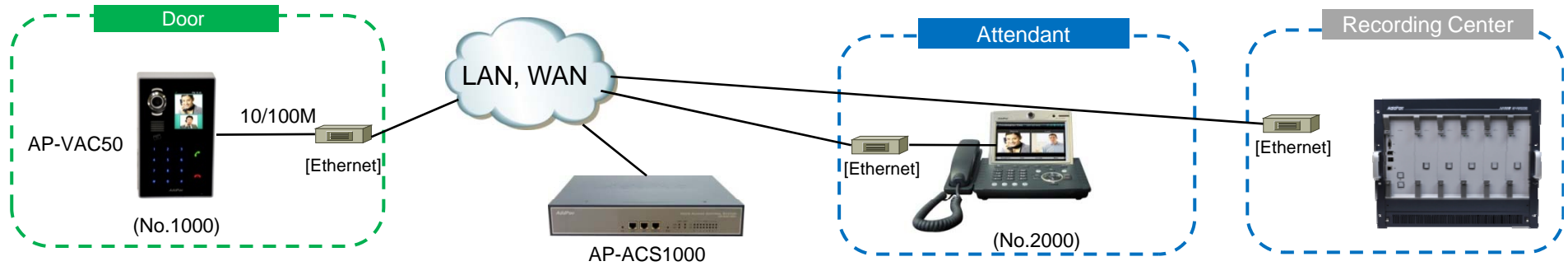

IP Soft Video Phone AP-SMP100



Product Overview

AP-SMP100 Smart Multimedia SoftPhone



AP-SMP100

Main Features

MS-Window based IP Soft Video Phone

IP Real-time Audio/Video Broadcasting Terminal Solution

Up to 30fps with VGA-Resolution(MPEG-4)

Video Conference Call Support (AddPac External MCU Inter-working)

Advanced Voice/Video Traffic QoS

Advanced Voice/Video Traffic QoS

SIP, H.323* Signaling Support

Support Various Call Signal via AddPac IP-PBX Inter-working

A/V Service Features

High-performance Video/Voice Codec Support

- H.263, MPEG-4, JPEG, and H.264
- G.711,G.726

Powerful Image Resolution Support

- QCIF(176x144), CIF(352x288), QVGA(320x240), 4CIF and VGA

64Kbps to 4Mbps Operating Video Traffic Bandwidth

Rate Control for Video Traffic QoS

Ensuring Optimized Quality

Frame Rate with Limited Bandwidth

High-end Error Resilient Against Various Packet Error

OSD Software Features

AP-SMP100 Smart Multimedia SoftPhone



OSD Software Features

AP-SMP100 Smart Multimedia SoftPhone



OSD Software Features

AP-SMP100 Smart Multimedia SoftPhone





Smart Digital Video Door Phone Recording Management Program

Smart DV_{ideo} door phoneR Management Program

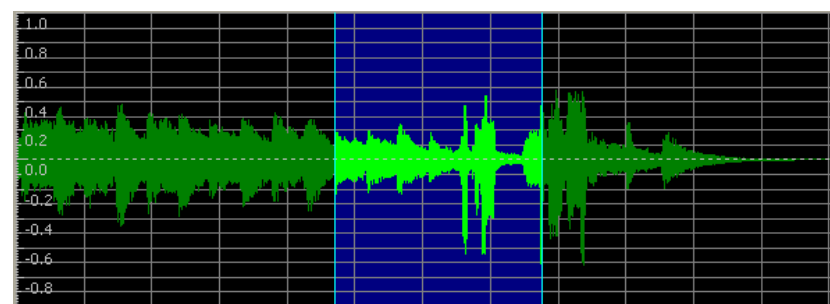
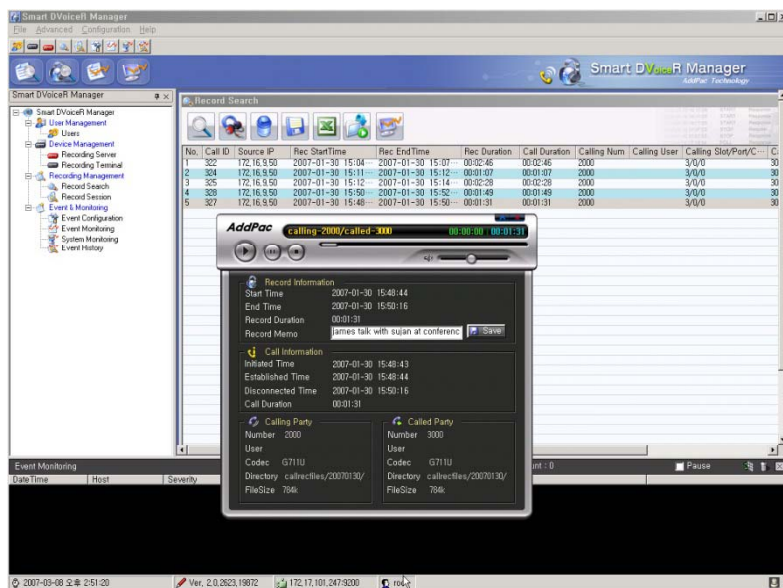

- Call History Management (search/modify/delete/save)
- Media Play Management (Play/Stop/Seek/Pause)
- Live Call List Management, Live Call Monitoring
- Local Backup (File Manager Support, PC HDD, DVD) and Local Play
- User Management (registration/modify/delete/search)
- Server Status (CPU/Memory/HDD) & Event Monitoring
- Recording Source Management (Video Phone, etc)
- Live Recording Board

UI example (recording file search..)

Recording File Search Result

Calling Num ▼

	Calling Number	Called Number	Recording Start Time	Recording End Time	Duration (sec)	Play
<input type="checkbox"/>	9000	5000	2010/03/17 09:50:45	2010/03/17 09:51:45	60	Play
<input checked="" type="checkbox"/>	9000	3000	2010/03/18 09:00:12	2010/03/17 09:00:45	33	Play
<input checked="" type="checkbox"/>	9002	9000	2010/03/18 10:50:12	2010/03/17 10:55:12	300	Play
<input type="checkbox"/>	9005	9000	2010/03/18 15:12:03	2010/03/18 15:12:13	10	Play
<input type="checkbox"/>	9006	9000	2010/03/19 01:10:23	2010/03/19 01:11:10	47	Play

[1] [2] [3] ... [Next]

Powerful Recording Search
 * calling number
 * called number
 * date
 * call identifier, etc

Recording Play

Recording Backup
 * selected files from recording server to PC storage

Calling Number : Video Door Phone
 Called Number : Video Phone (attendant)



Thank you!

AddPac Technology Co., Ltd.
Sales and Marketing

Phone +82.2.568.3848 (KOREA)

FAX +82.2.568.3847 (KOREA)

E-mail sales@addpac.com