



AP-SH30 Smart Hub Cloud for Zwave Sensor Device

High Performance Smart Hub Solution for Zwave Sensors



AddPac

AddPac Technology

Sales and Marketing

www.addpac.com

Contents

- Product Overview
- Hardware Specification
- APOS Technology
- Network Protocols
- Network Management
- Security Management
- Application Service
- Ordering Information

Product Overview

AP-SH30 Smart Hub Cloud for ZWave sensors

- Cloud based Advanced Smart Home Solution
- Standalone Mode & Cloud Mode Both Support
- ZWave Sensor Interface Support
- External ZWave Antenna Support for Performance
- Smart IP Routing Service Features for Sensor Network
- High Performance RISC Programmable Architecture
- Two(2) 10/100Mbps Fast Ethernet
- High Performance LAN-to-ZWave Routing Capability
- Cloud Server based Smart Web based Management
- Cloud Server based Smart Phone/Tab/Pad Application Software
- Smart Web Manager Support for Standalone Mode
- Light and Compact Design with External Power Supply
- Power On/Off Switch

Product Highlights

AP-SH30 Smart Hub Cloud for ZWave sensors

Powerful Smart Hub Cloud for ZWave sensors

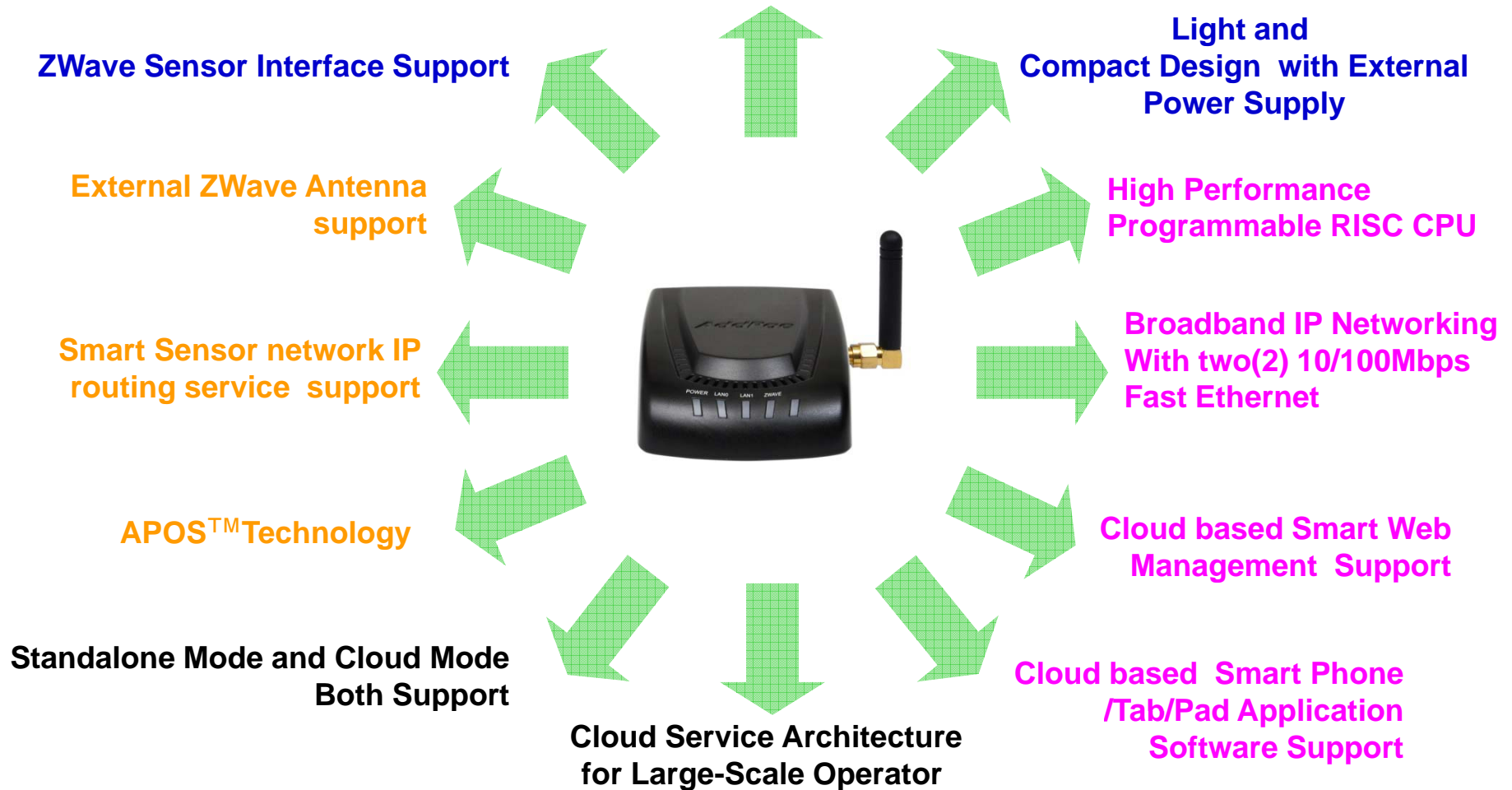

AddPac

www.addpac.com

APOS Technology

AP-SH30 Smart Hub Cloud for ZWave sensors

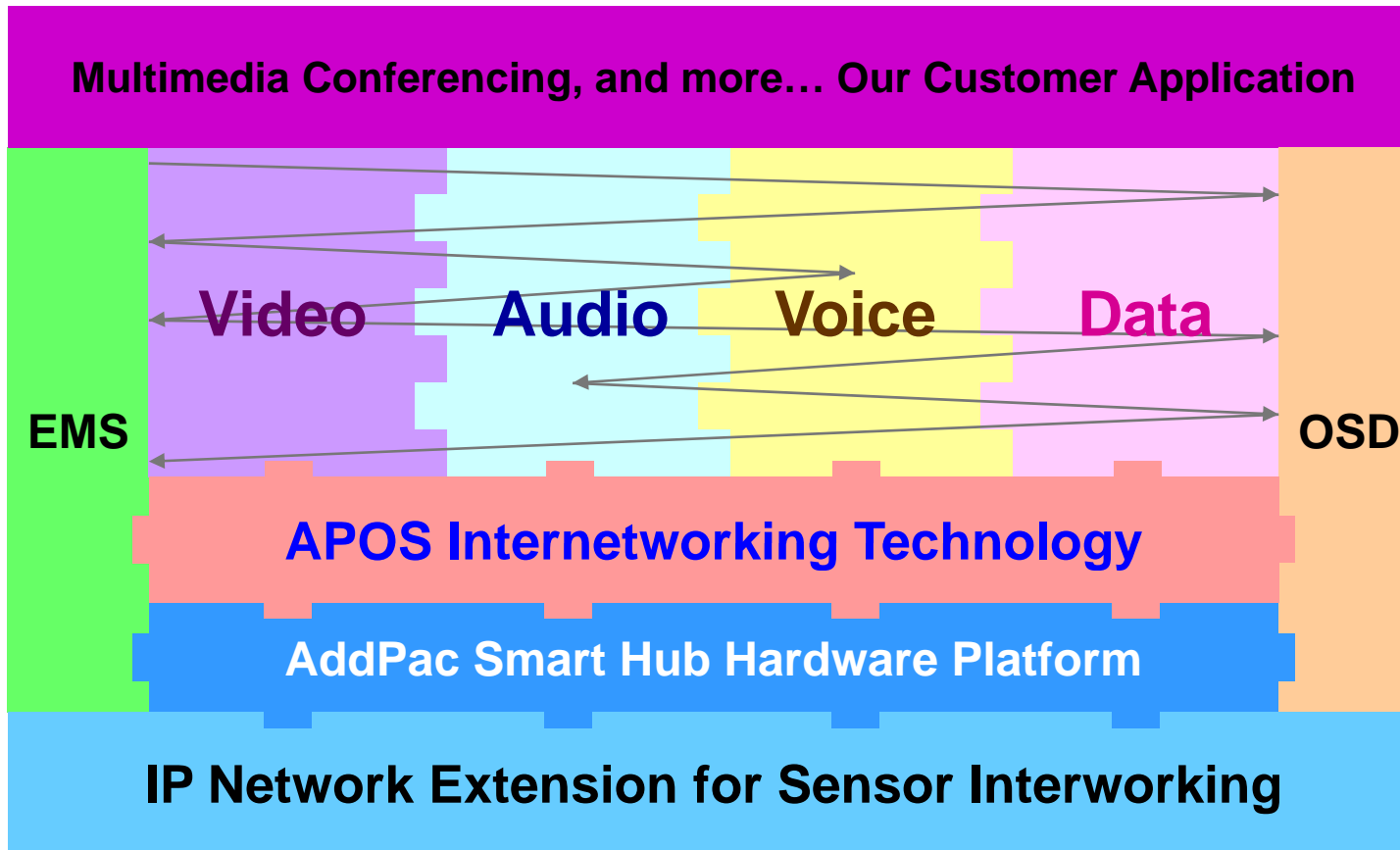

- APOS : AddPac Internetworking Operating System
- OSD : On- Screen Display
- EMS : Element Management System

Hardware Specification

AP-SH30 Smart Hub Cloud for ZWave sensors

RISC
CPU

- RISC Microprocessor Computing Power
- 1-Port ZWave Interface
- 1-Port ZWave Antenna
- Network Interface
 - Two(2) 10/100Mbps Fast Ethernet (RJ45)
- Run LED, LAN LED, Port LEDs
- External Power Supply
- Power On/Off Switch

Hardware Specification

AP-SH30 Smart Hub Cloud for ZWave sensors



Smart Hub Service Diagram

AP-SH30 Smart Hub Internal H/W Block Diagram

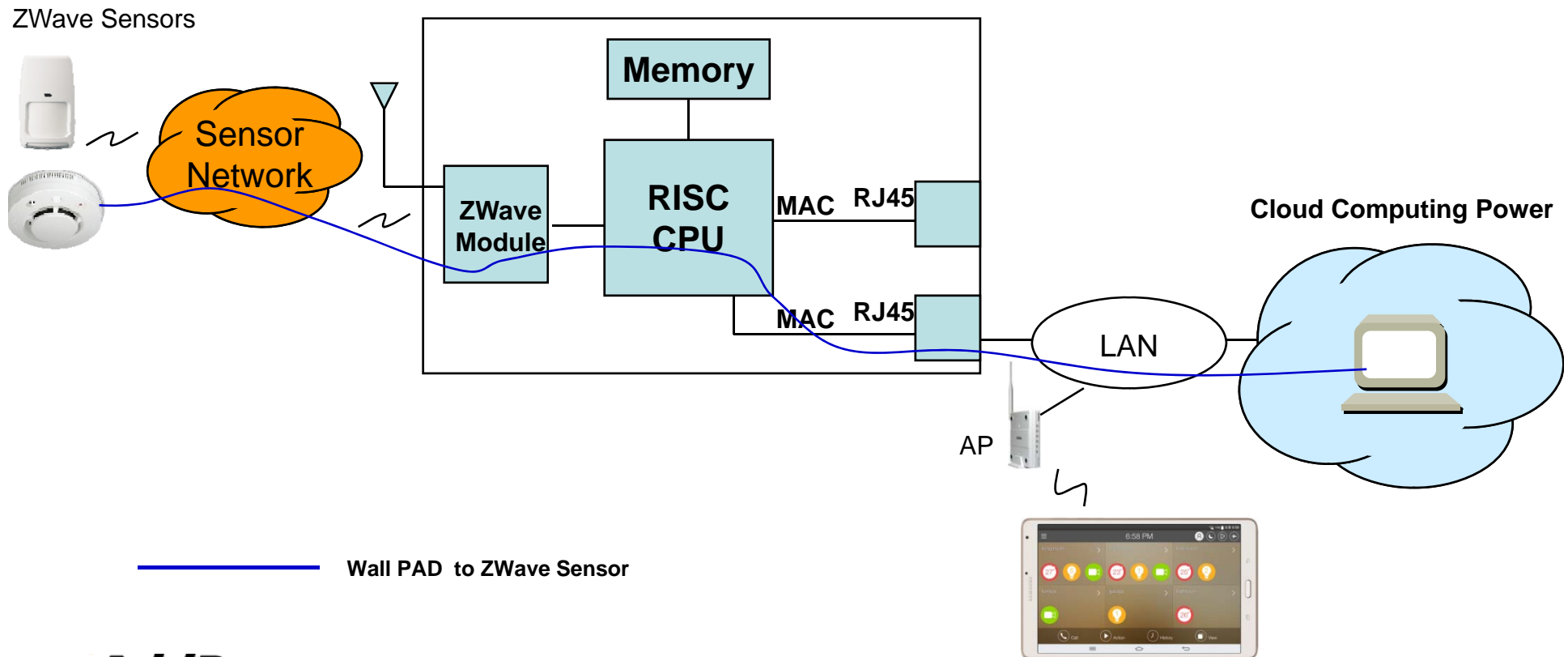

— Wall PAD to ZWave Sensor

Hardware Specification

AP-SH30 Smart Hub Cloud for ZWave sensors

AP-SH30 Smart Hub	Basic Specifications	
Microprocessor	RISC Microprocessor	
Memory	Flash Memory (NAND)	256Mbyte
	SDRAM Memory	32Mbyte High-Speed SDRAM
Sensor Interface	One(1)-Port ZWave Interface	
ZWave Antenna Interface	External ZWave Antenna	
Network Interface	2-Port 10/100Mbps Ethernet Interface(2xRJ-45)	
Power Requirement	Power Supply Adaptor / VAC 110~220V, 50/60Hz, 5V, 2A	
Operating Temperature	0°C ~ 45°C (32 °F ~ 122°F)	
Storage Temperature	-40°C ~ 85°C (-40°C ~ 185°F)	
Relative Humidity	5% ~ 95% (Non-condensing)	
Dimension	28.8mm x 77mm x 111mm (H x W x D)	
Weight (Kg)	0.12Kg	

Hardware Specification

AP-SH30 Smart Hub Cloud for ZWave sensors

Network interface Configurations

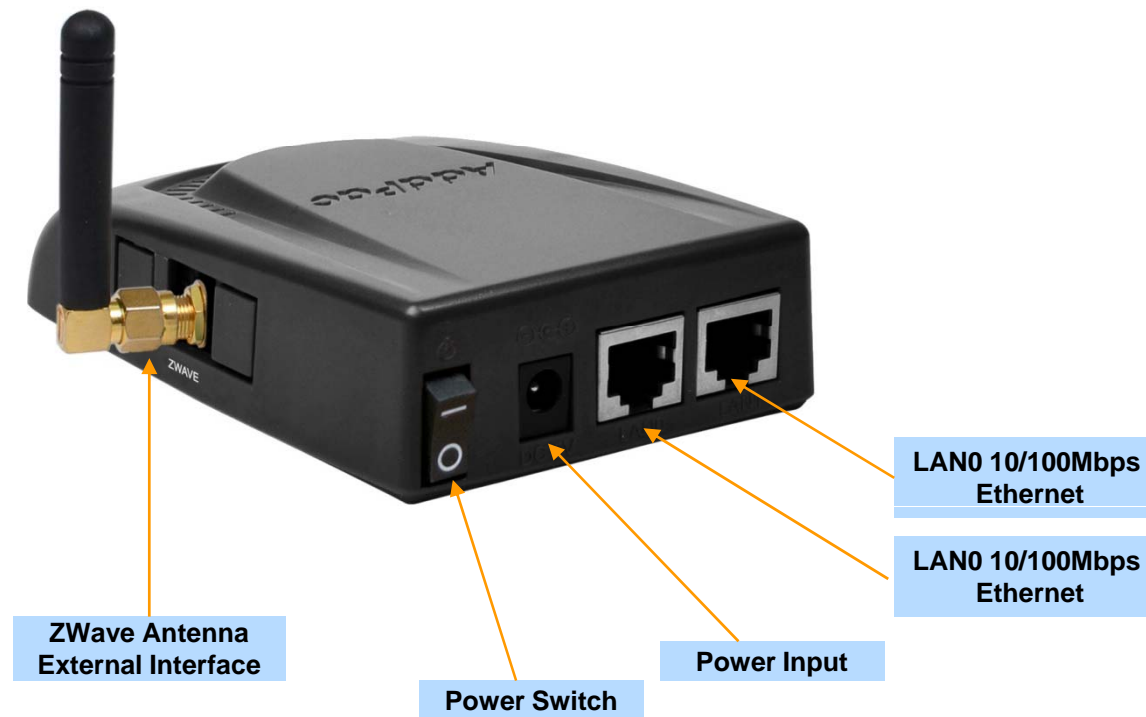

Network Protocols

AP-SH30 Smart Hub Cloud for ZWave sensors

Basic Network Protocols

- ARP, IPv4, TCP, UDP, ICMP, SCTP, IGMP, MLD

Routing Protocol

- IPv4 : Static

Service Protocol

- FTP, Telnet, TFTP, DHCP Server/Relay, SNMP Server
- CDP (Cisco Discovery Protocol)
- DNS Resolver , DDNS(nsupdate)
- Bridge
- Syslog

IPv4 Address Configuration

- Fixed (Static)
- DHCP
- PPPoE

Miscellaneous

- Cisco Style CLI
- Standard & Extended IPv4 Access List
- Multi-level User Account Management
- IP accounting
- STUN Client

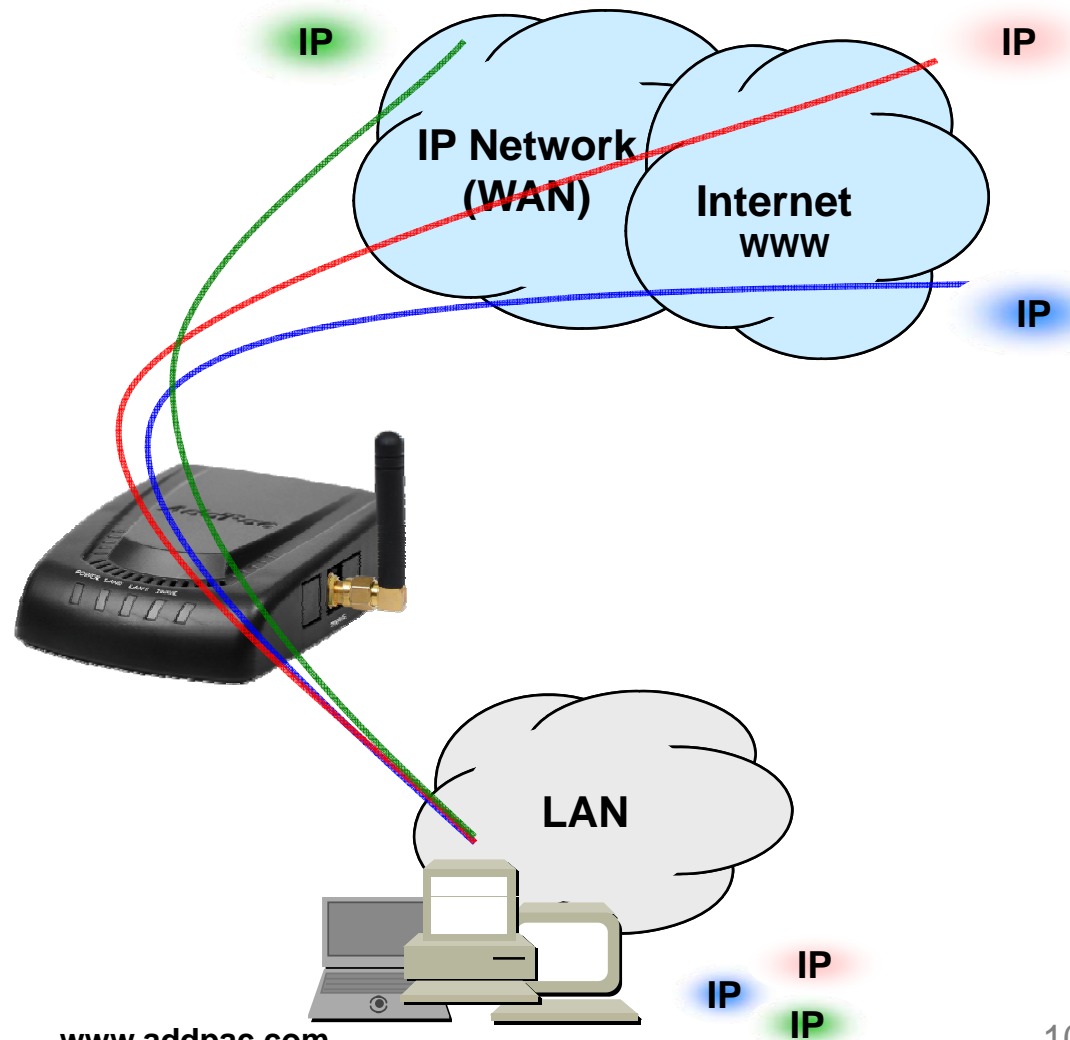

Network Management

AP-SH30 Smart Hub Cloud for ZWave sensors

- **SNMP**

- Standard Simple Network Management Protocol(SNMP) Agent support
- MIB v1 and v2 Support

- **Web-based Management**

- Smart Easy Setup
- Standard Voice Interface
- Standard PSTN Back-up Interface

- **Watch-dog Function**

- Hardware, Software watch-dog services

- **Remote Management**

- Telnet
- Rlogin

- **Auto Upgrade Service**

- HTTP server based APOS image and configuration file auto-upgrade support

- **Batch Job Function**

- Text based script downloading

- **Interoperable with AP-SNMS Service**

- AddPac Smart Network Management System

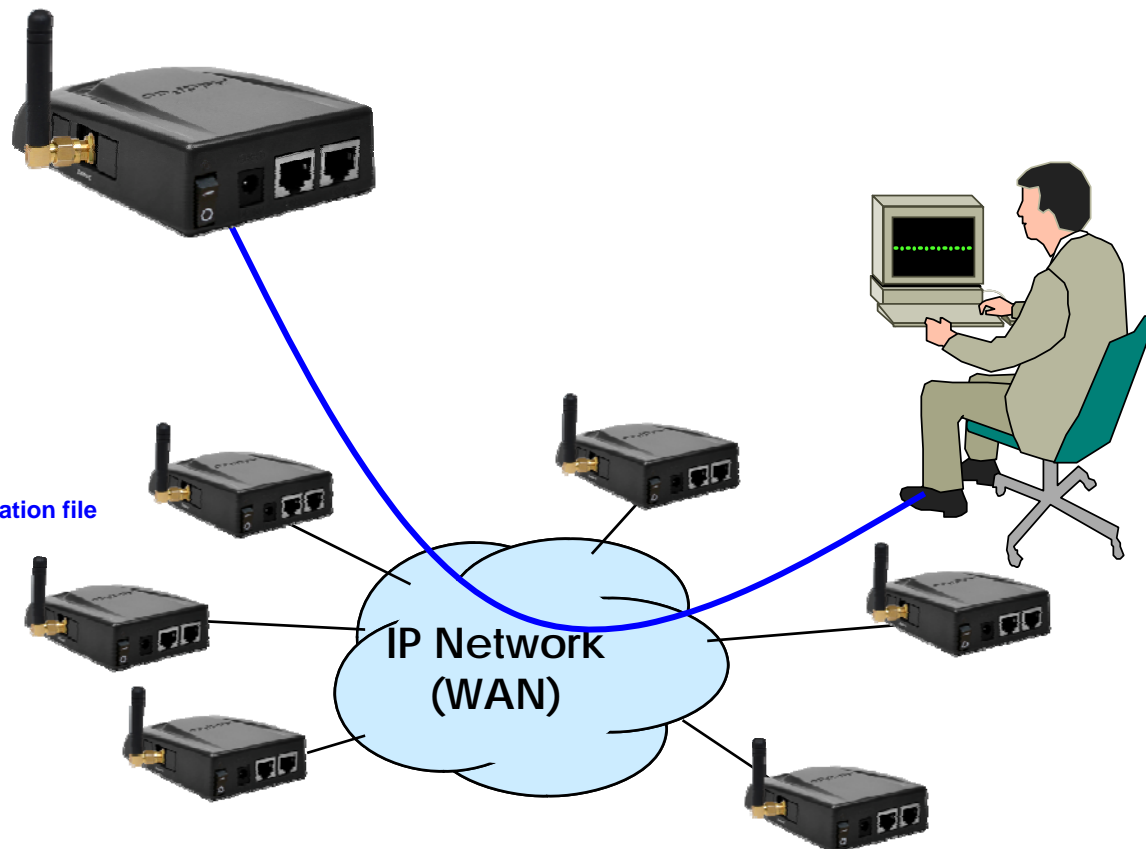

Security Management

AP-SH30 Smart Hub Cloud for ZWave sensors

- IP packet filtering
- IP access list
- User authentication function
 - Password Authentication Protocol (PAP)
 - Challenge Handshake Authentication Protocol (CHAP)
- Enable/Disable specific protocols
- Auto-square connect of Telnet session
- Account Management function for multi-level user
- SNMP/TELNET/FTP/HTTP/TFTP port assignment function
- SNMP/TELNET/FTP access list management
- Boot mode security checking function

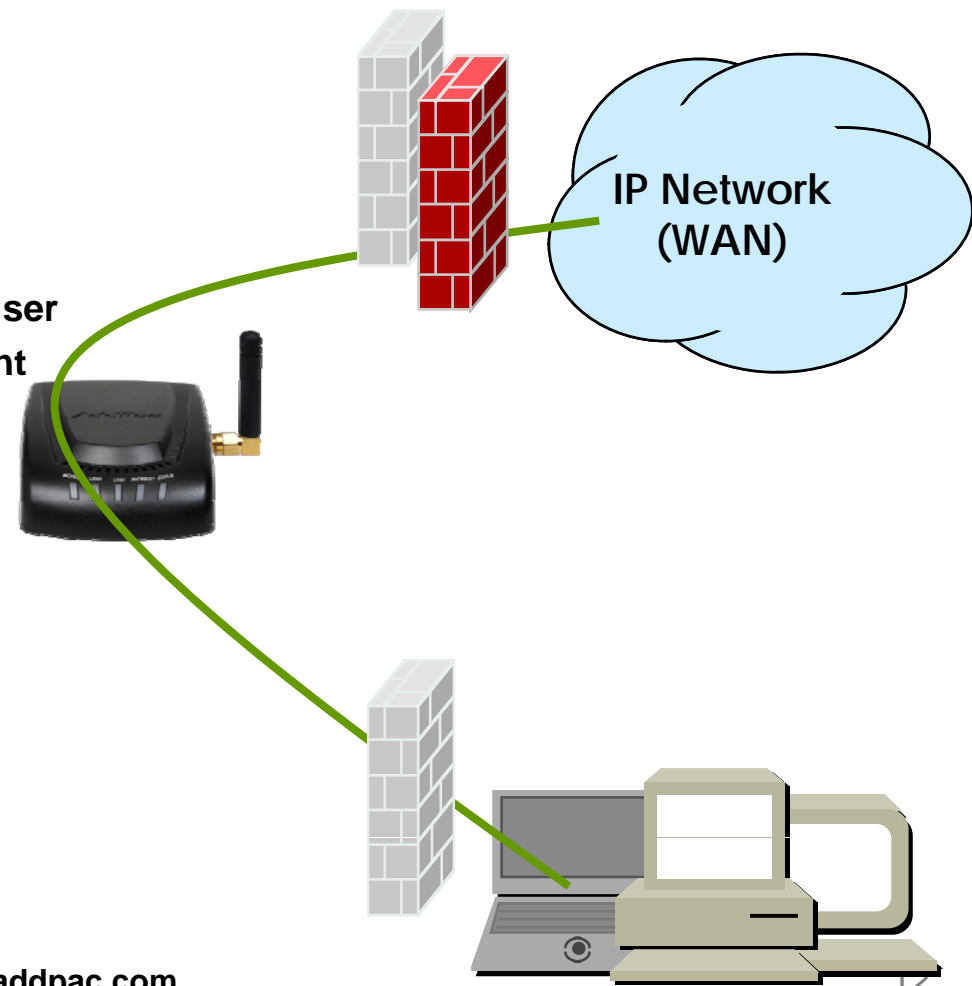

Standard Application

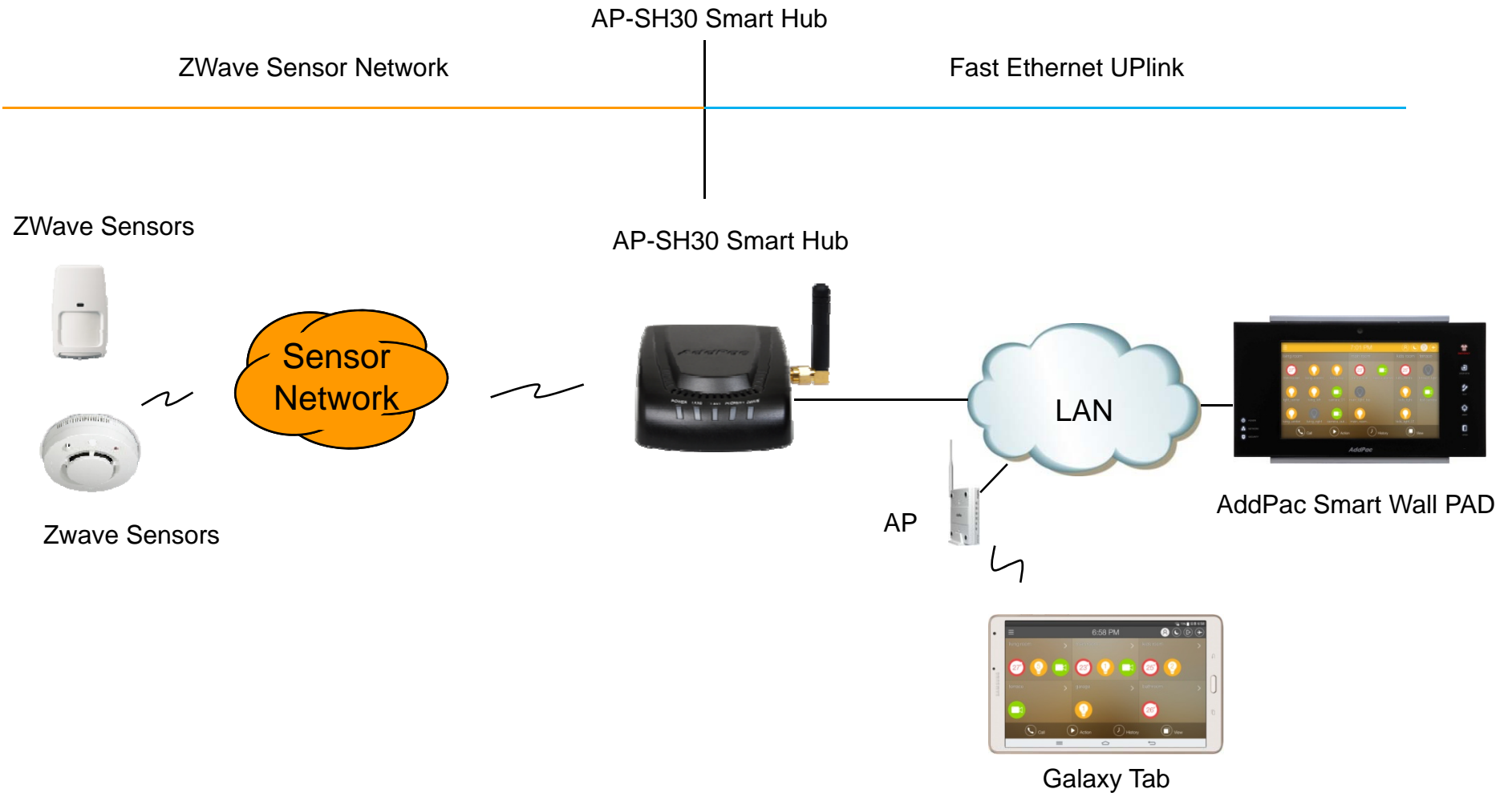

Standard Application (Standalone Service Mode)

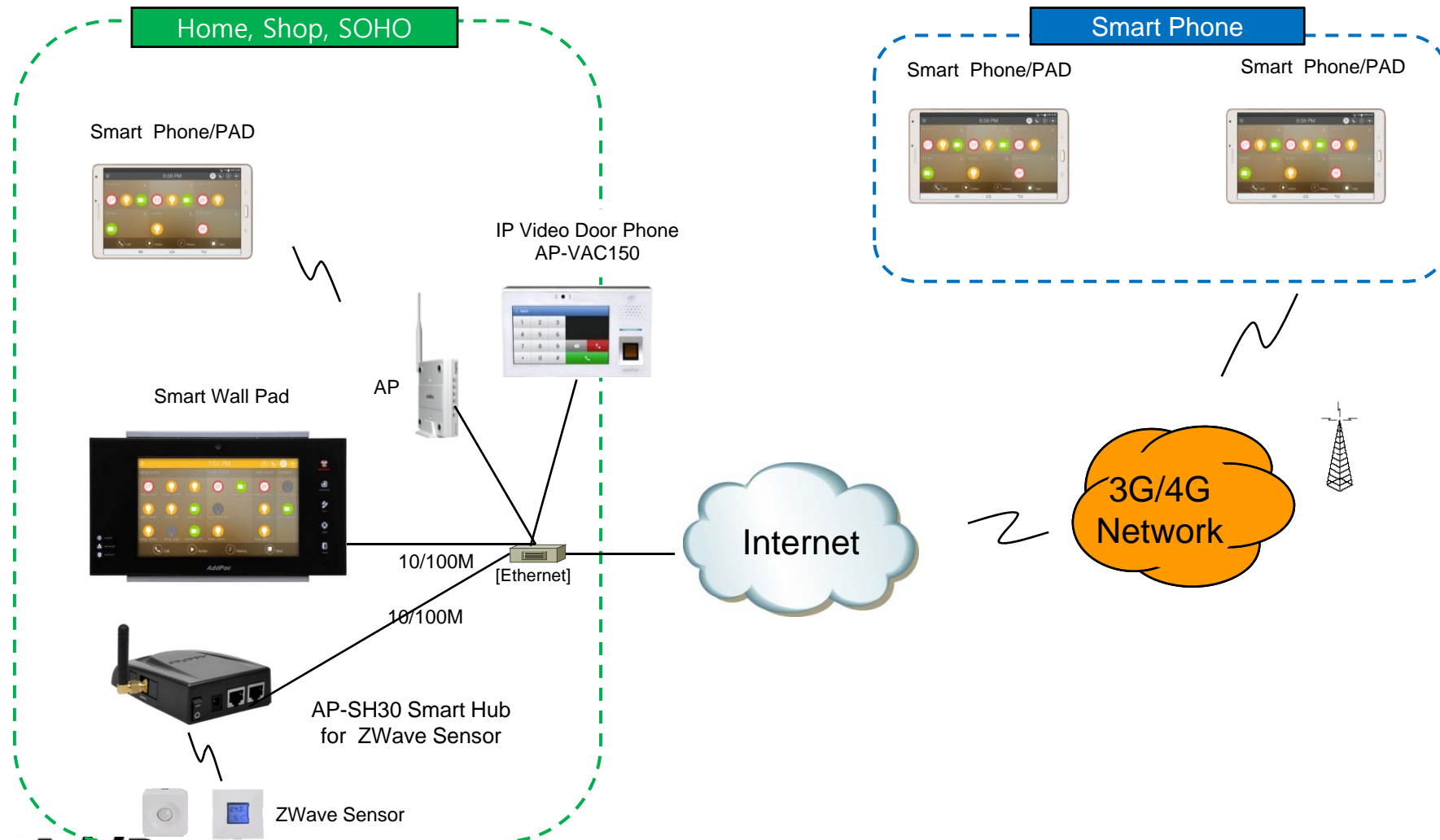

Standard Application (Standalone Service Mode)

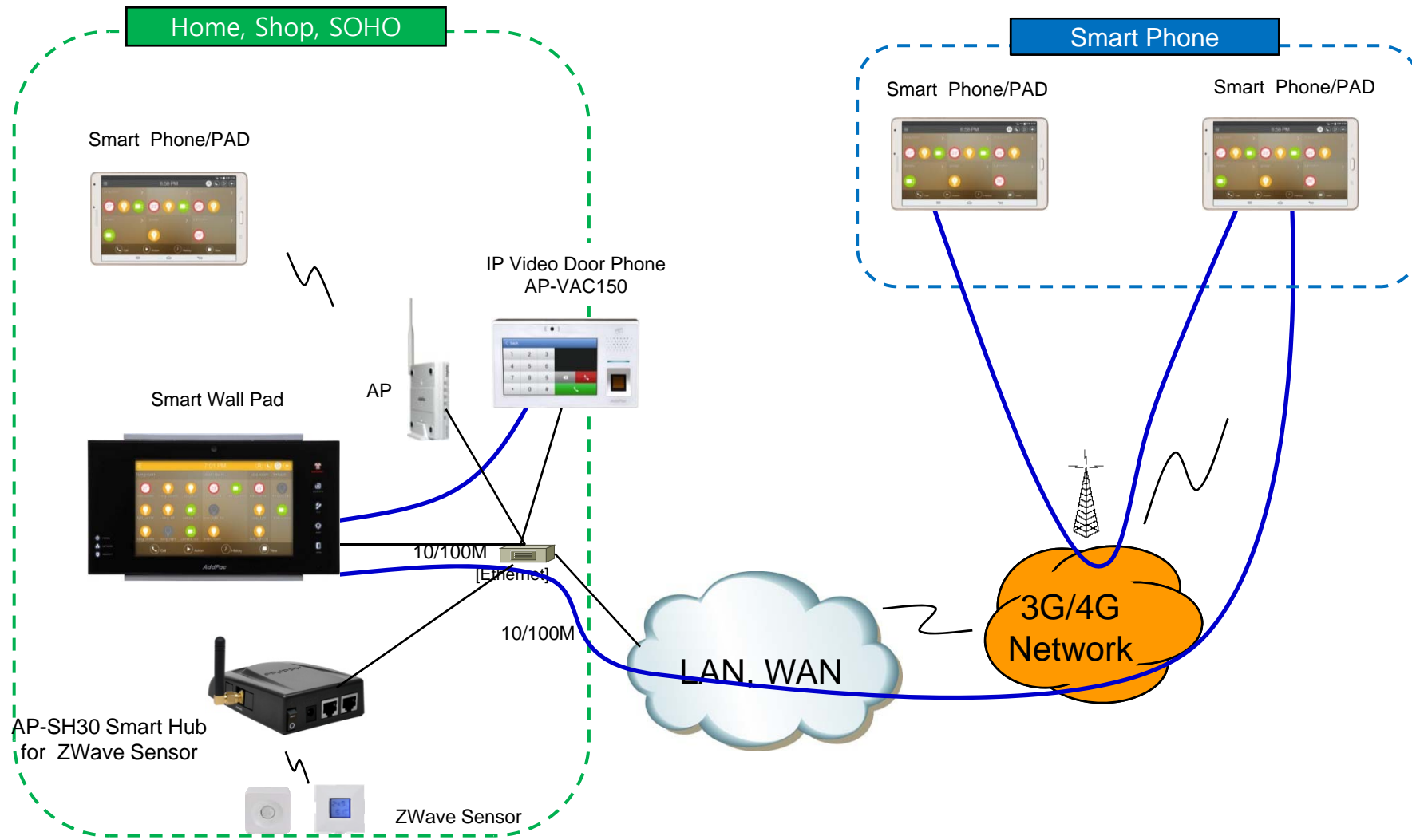

Smart Hub Clouding Service Mode

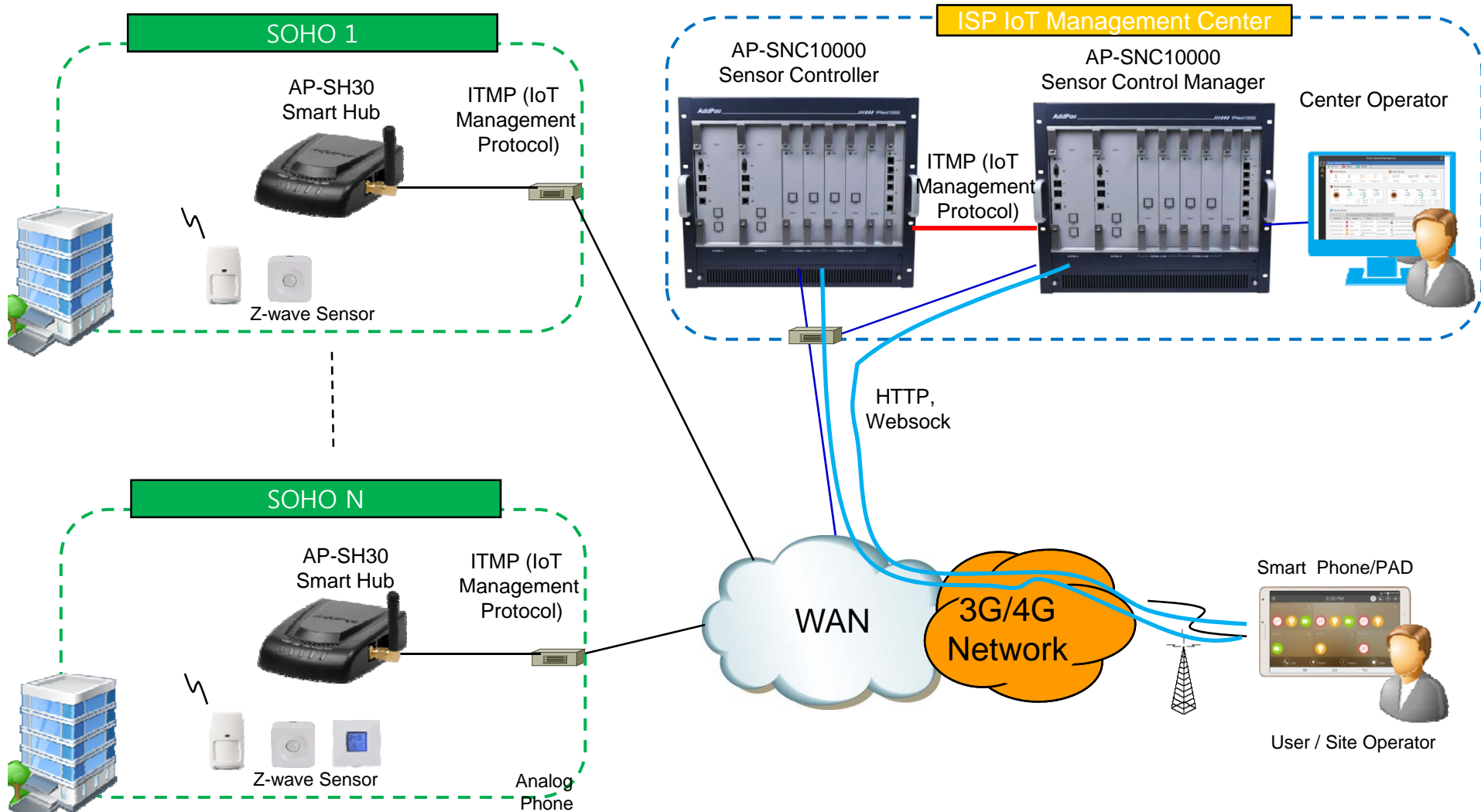

Ordering Information

- **AP-SH30 Smart Hub Cloud Hardware**
 - AP-SH30 Smart Hub Cloud Main Body
 - RISC Microprocessor
 - 1-Port ZWave Interface with external antenna
 - 2-Port 10/100Mbps Fast Ethernet(RJ45)
 - Including Network Cable, Antenna & Ext. Power Supply, etc.
- **Built-in APOS Internetworking Software for AP-SH30**
- **Including 1 Year Hardware Warranty**
- **Product Documents**
 - Install and Operation Guide (PDF)
- **Pricing**
 - AddPac Technology Regional Sales Manager
 - Authorized Sales and Marketing Representatives
 - Please Contact www.addpac.com

Smart Hub Series

Thank you!

AddPac Technology Co., Ltd.
Sales and Marketing

Phone +82.2.568.3848 (KOREA)

FAX +82.2.568.3847 (KOREA)

E-mail sales@addpac.com