

AP-VAC350

IP Video Door Phone

High Performance IP Video Door Phone Solution

Motion Sensor Interworking
Service for Video Door Monitoring



Motion Sensor

AddPac

AddPac Technology

2015, Sales and Marketing

www.addpac.com

Contents

- Video Monitoring Service Overview using Motion Sensor
- Smart Video Controller Overview
- Video Monitoring Service Diagram
- Video Monitoring Service Scenario
- Video Monitoring Service RTSP Call Flow
- Smart Video Controller Configuration
 - Configuration
 - Program Setup

Overview

- Motion Sensor Interworking Service for Video Monitoring Service
- Video Door Phone Side : External Motion Sensor
- PC Side : Smart Video Controller Software and MS-window based Video Decoder Program such as VLC, etc
- RTSP(Real Time Streaming Protocol) Protocol Support
- Multiple Video Decoder & Displayer Controlling
- Application Aware Motion Detection Algorithm

Smart Video Controller Overview

- Smart Video Controller Features
 - MS Window based Program : XP, Vista, Window7 support
 - Video: MS Window Program, PC based Video Decoder & Displayer
 - RTSP(Real Time Streaming Protocol) Protocol Support
 - Multiple Video Displayer Controlling
 - Video Monitoring Service using external motion sensor
 - I. AP-VAC350 Video Monitoring with VLC Player

Video Monitoring Service Diagram

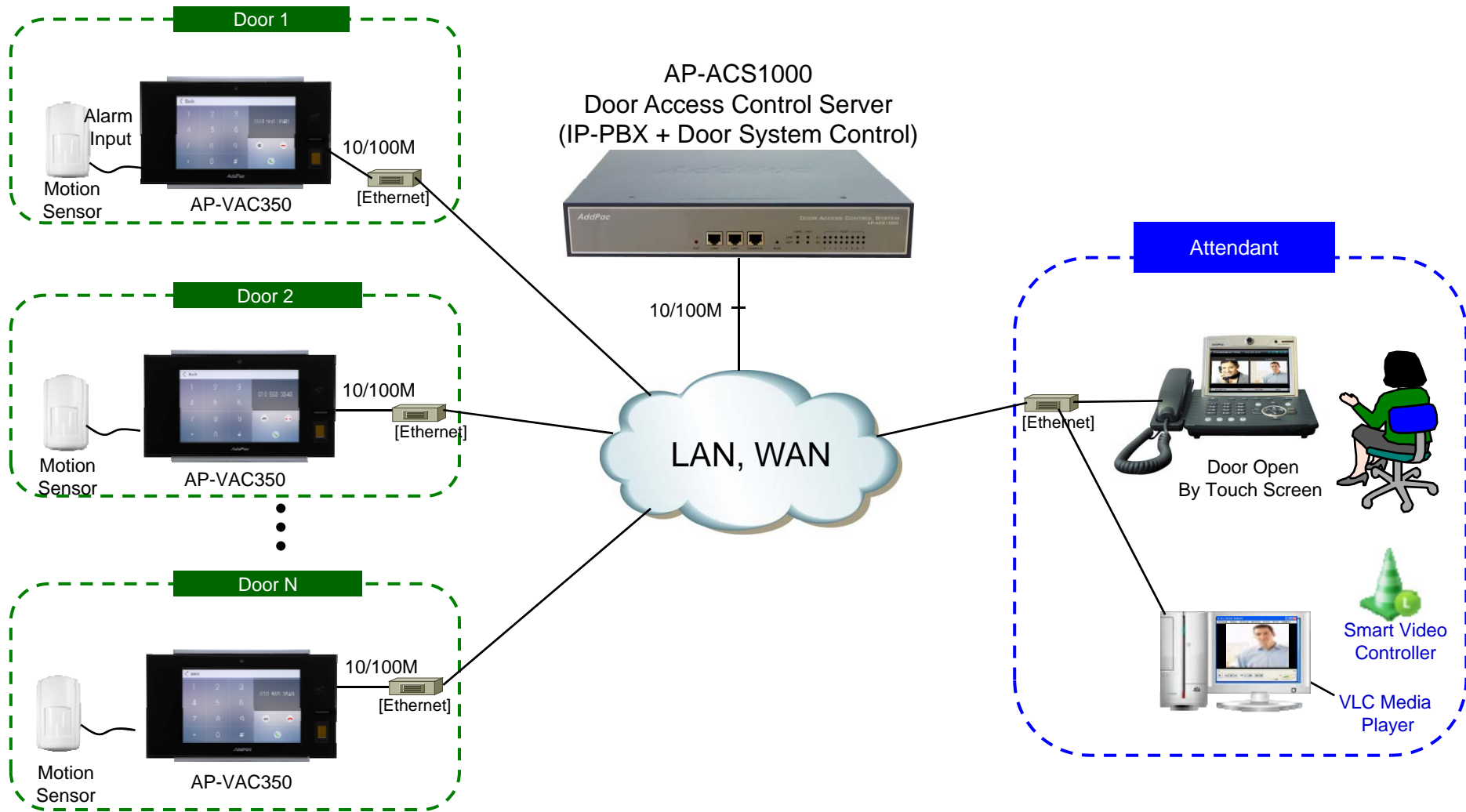

Video Monitoring Service Scenario

: AP-VAC50 Video Monitoring with VLC

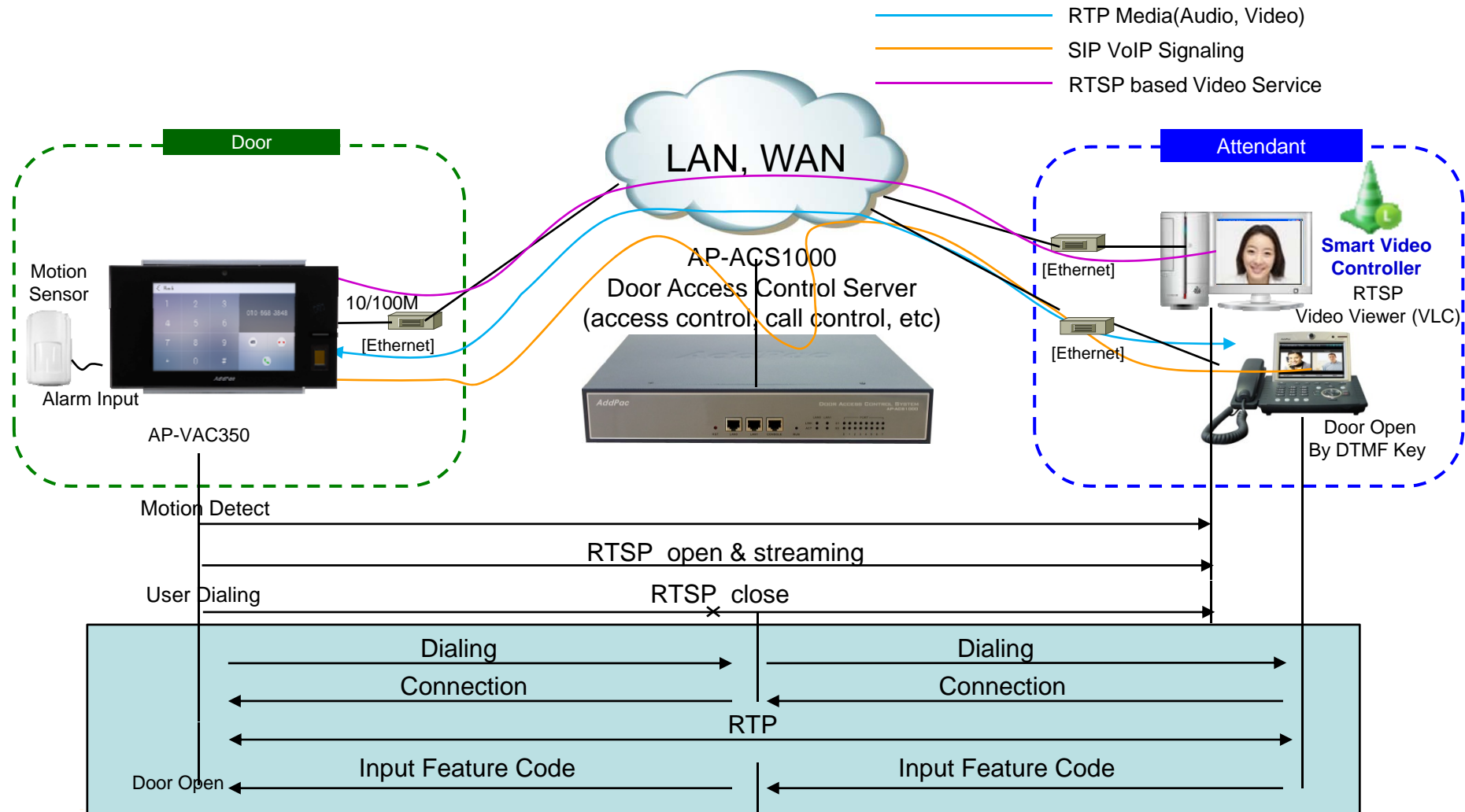

Video Monitoring Service RTSP Call Flow

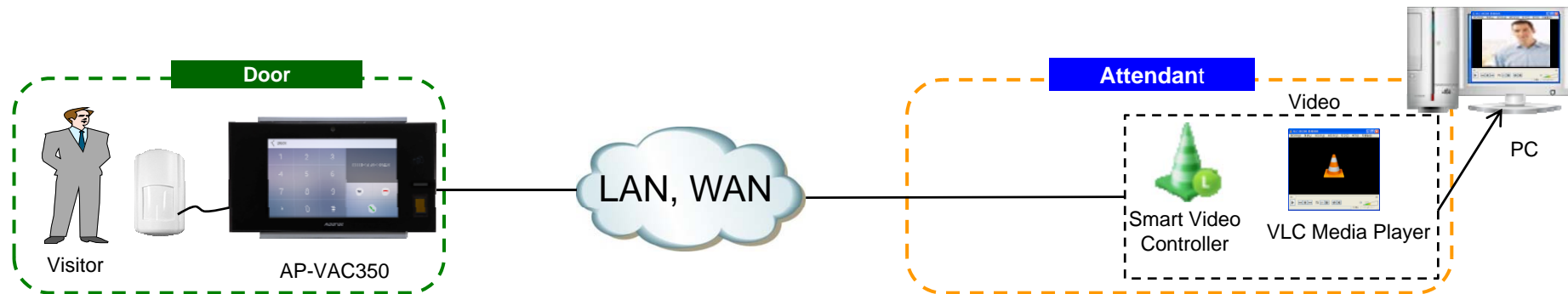

Motion Detect

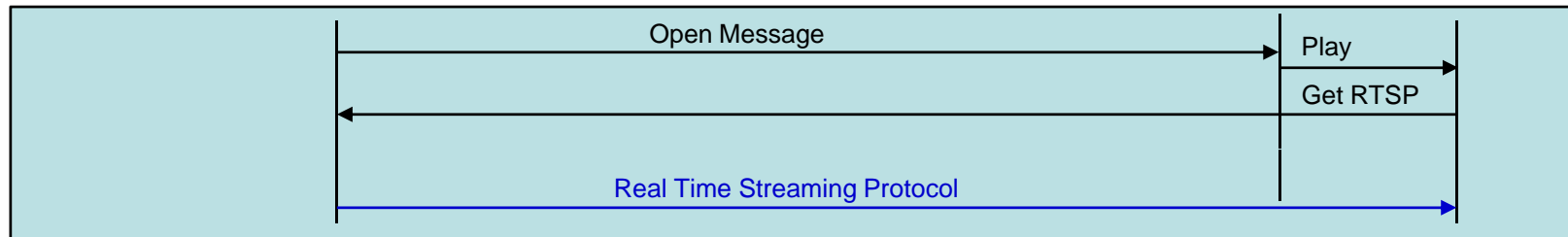

No Motion

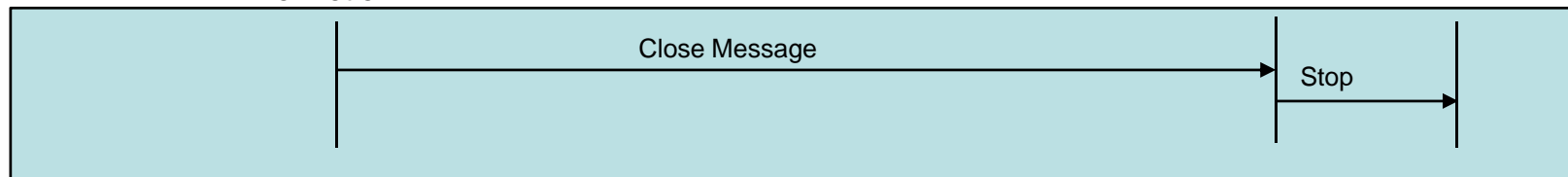

Smart Video Controller Configuration

No.	Called-Number	IP Address	Port
1	1000	172.17.117.20	19999
2	2000	172.17.117.28	19999
3			
4			
5			
6			
7			
8			
9			
10			
11			

- ① Internal extension (line) number
- ② Personal Computer's IP Address
- ③ Port Number (Default .19999)

[Figure 1]
AP-VAC50 Smart Web

Smart Video Controller Configuration (Cont.)

Smart Video Controller Program Setup

VLC Media Player Program must be pre-installed before Smart Video Controller program setup procedure.

(VLC Player is MS window software that support RTSP based Video Decoder & Display service

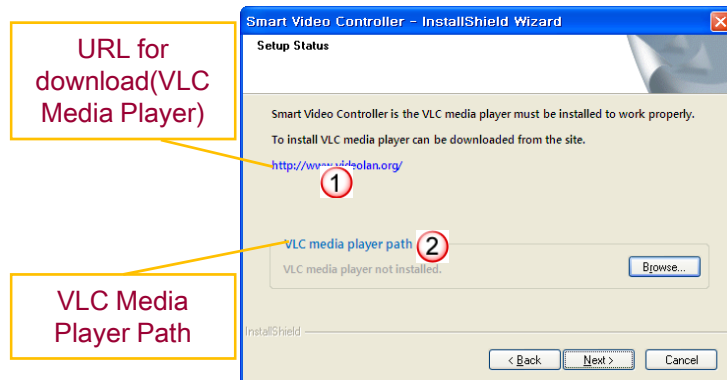

[Figure 1]
VLC Media Player Install Shield

- ① VLC Program Download URL Address
- ② VLC Program Execution File Path

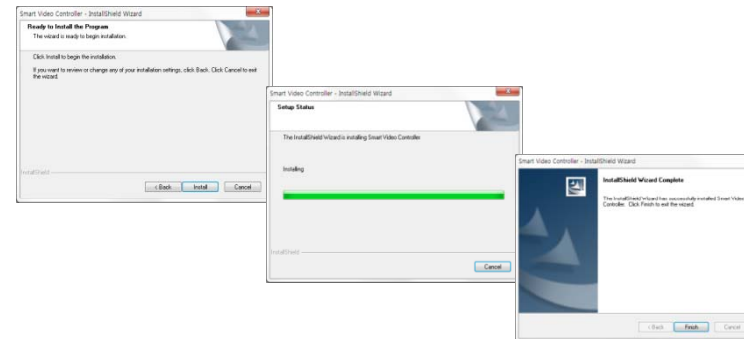

[Figure 2]
Smart Video Controller Install Progress

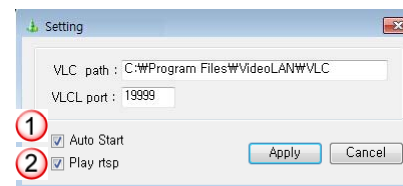

[Figure 3]
Smart Video Controller Setting

- ① Program Auto Start at PC booting time
- ② Program enable/disable



Thank you!

AddPac Technology Co., Ltd.
Sales and Marketing

Phone +82.2.568.3848 (KOREA)

FAX +82.2.568.3847 (KOREA)

E-mail sales@addpac.com