

Smart IoT (Internet of things) Solution



AddPac

AddPac Technology

Sales and Marketing

Contents

- Smart IoT Solution Network Diagram
- Smart IoT Solution Overview
- Smart Hubs for Sensor Devices
- Smart Hub Cloud for Large-Scale Operator
- Enterprise Smart Hub
- Smart Sensor Network Controller
- Smart Hub + Wall PAD
- Sensor Control Wall PAD
- Smart Phone/Tab Appl.



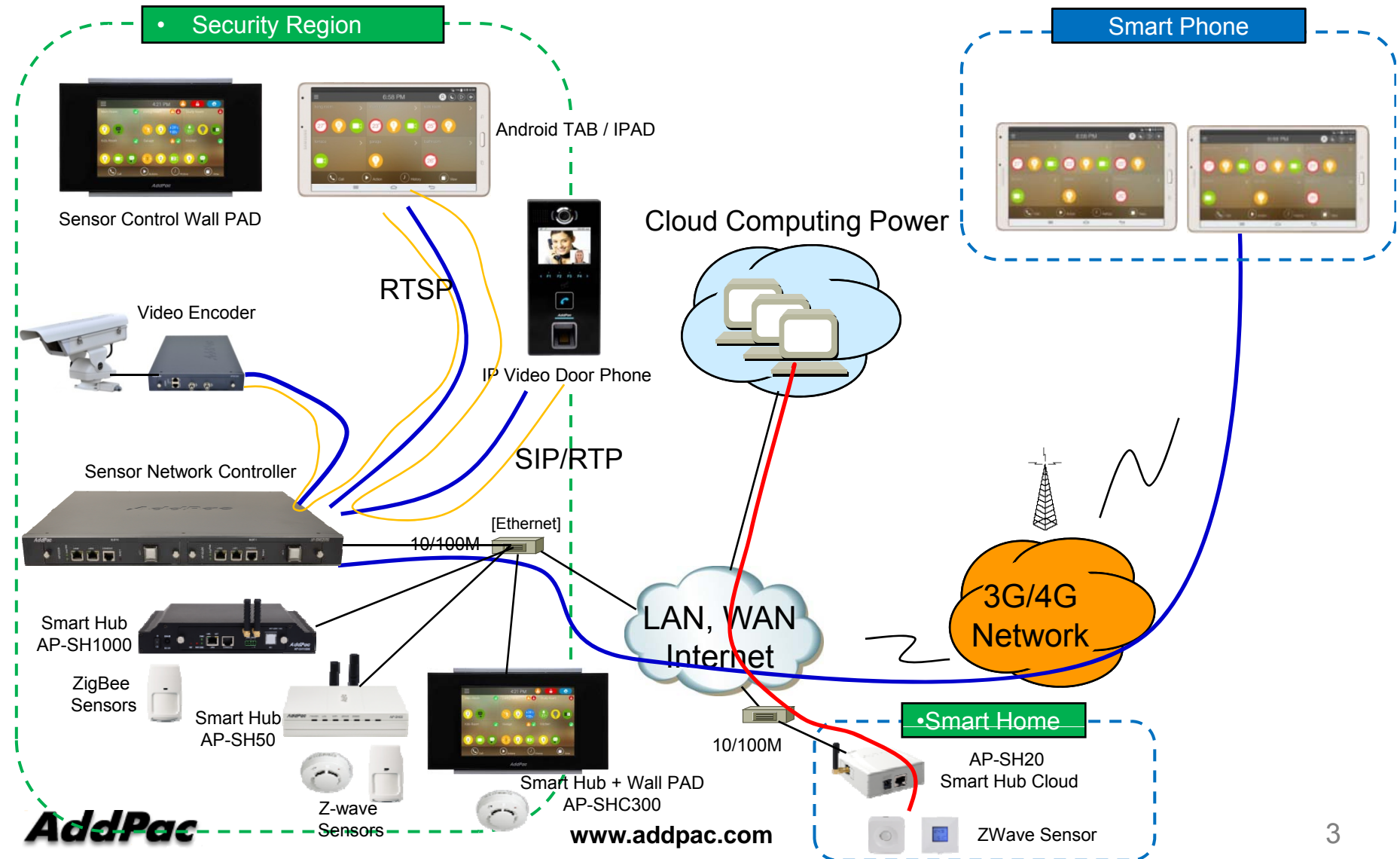



Smart IoT Solution Network Diagram





Overview





Smart IoT Equipment Table

Smart Home Products	Description	Model
	Smart Hub for ZigBee/ZWave Sensors	AP-SH50, AP-SH50ZW, AP-SHD100
	Smart Hub Cloud for ZWave Sensors	AP-SH20, AP-SH20W
	Enterprise Smart Hub	AP-SH1000
	Smart Sensor Network Controller	AP-SNC2000
	Smart Hub + Wall PAD	AP-SHC300
	Sensor Control Wall PAD	AP-SWP100
	Smart Phone and Tab/Pad Appl.	AP-ASH100, AP-ISH100



Smart Hub for Wireless/Wired Sensor Devices

Smart Hub Equipment Comparison Table

Model	AP-SH50	AP-SH50ZW	AP-SAH50	AP-SHD50
Service Features				
Sensor Type	Wireless Zigbee, Zwave	Wireless Zwave Only	Wired	Wireless/Wired Zigbee, Zwave
Wired Sensor Port	N/A	N/A	6-Port	6-Port
Smart Appl. for Phone, PAD	Support	Support	Support	Support
Smart Web Manager	Support	Support	Support	Support
LAN Port	1	1	1	1
PoE(Optional)	Option	Option	Option	Option

Smart Hub Service Diagram (Smart Home Solution)

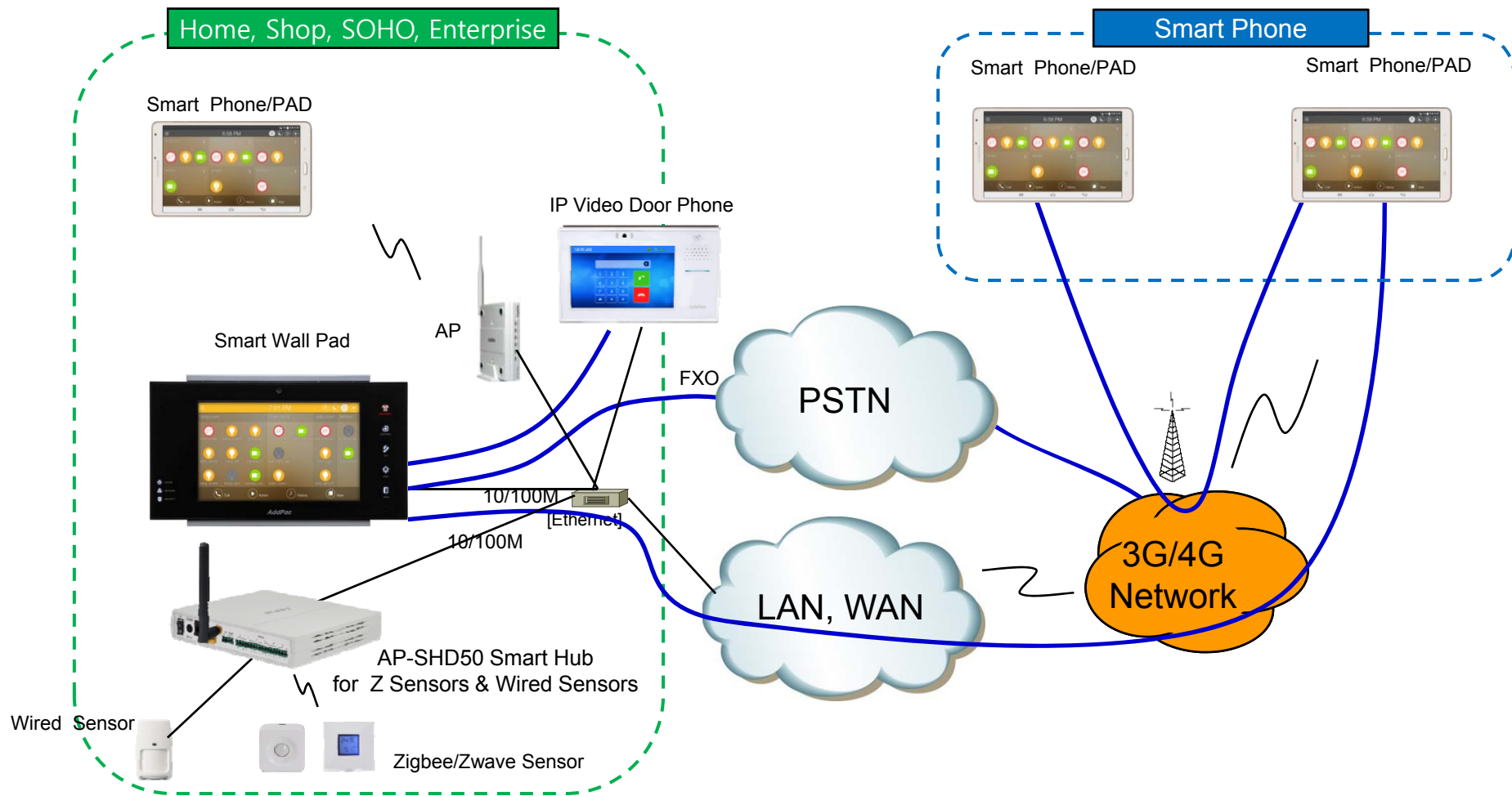

Smart Hub Service Diagram (Standalone Type Smart Hub Device)

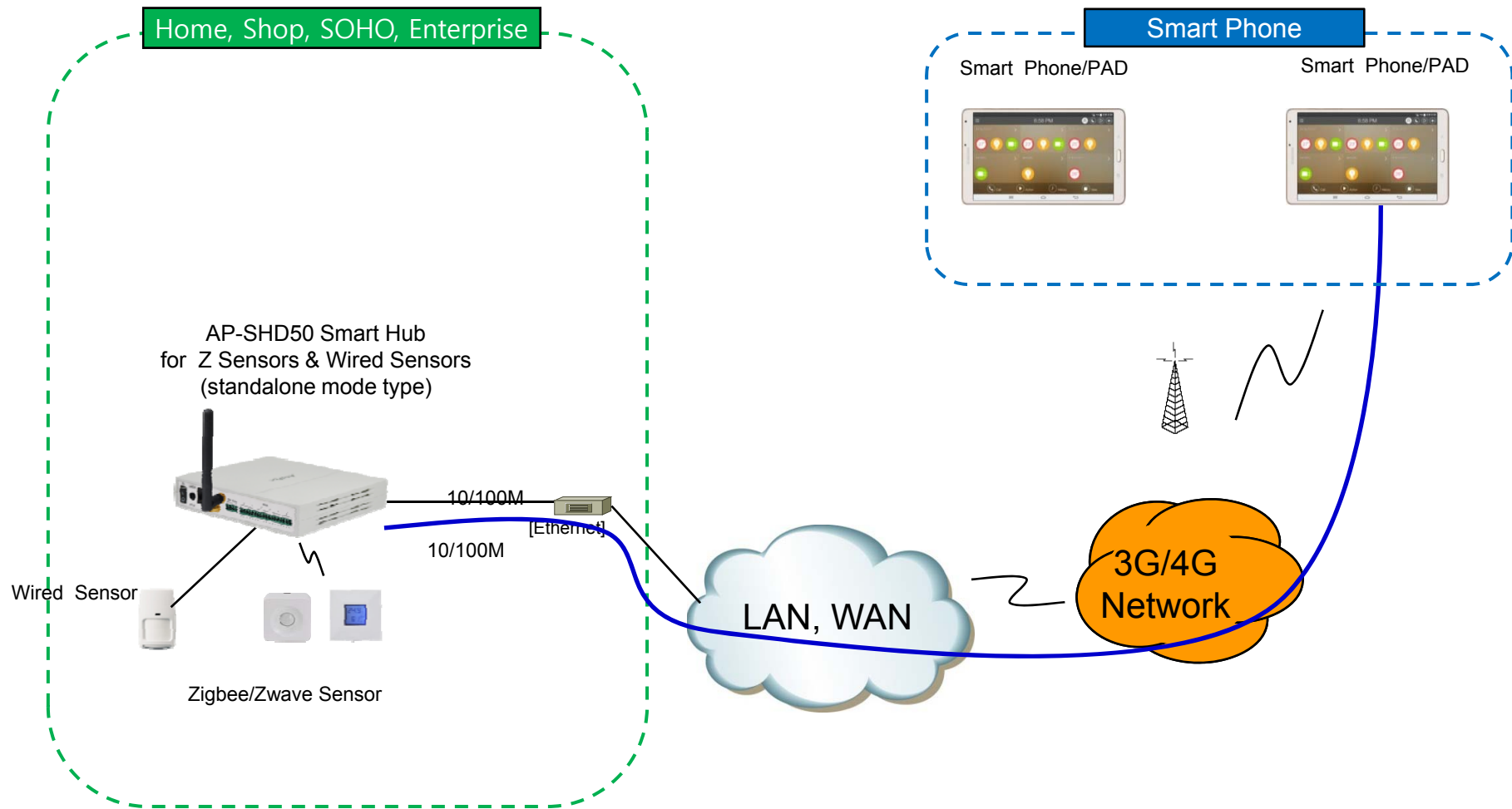

Smart Hub Service Diagram (Clone Type Smart Hub Device)

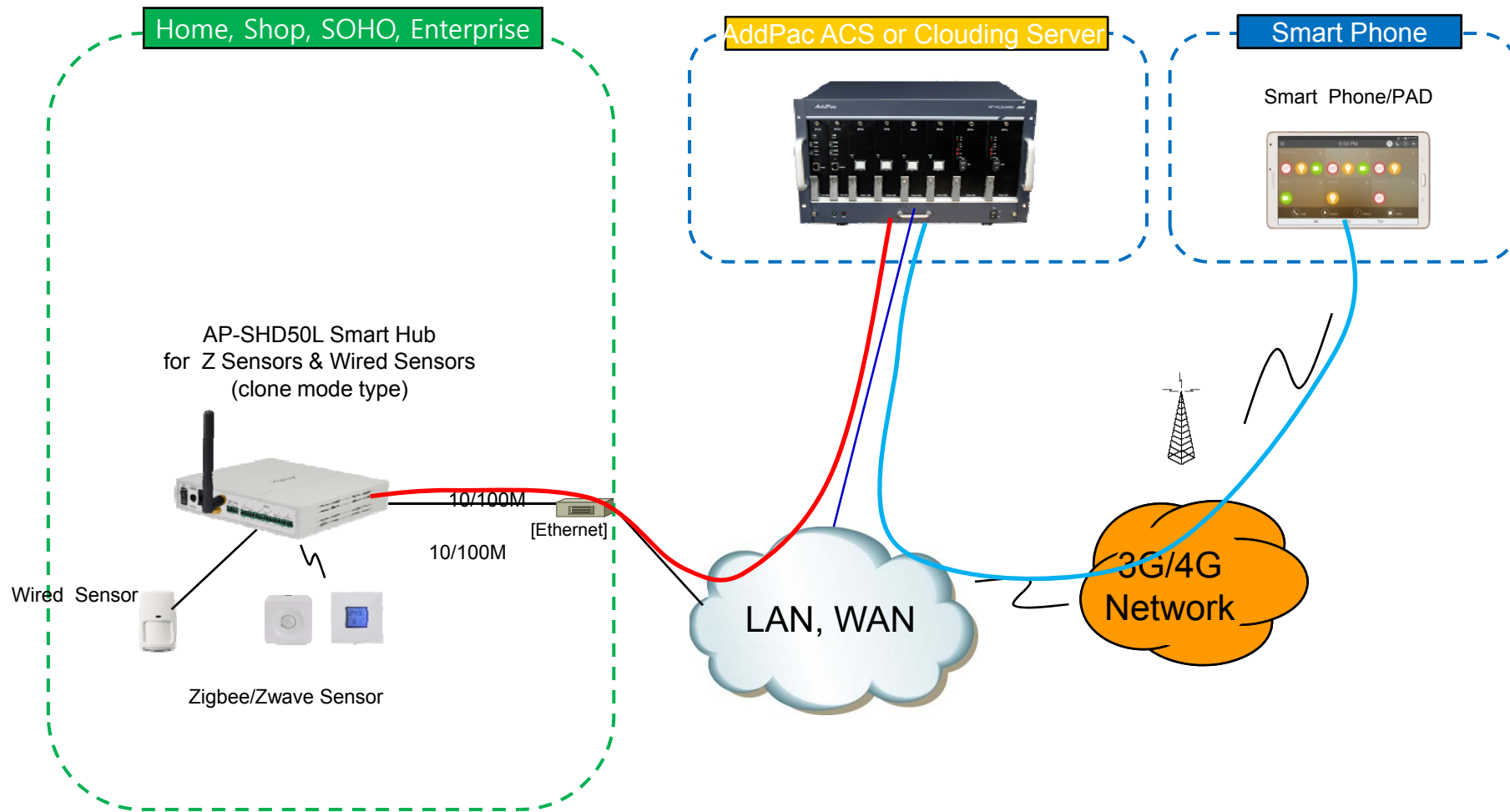



AP-SH50 Smart Hub

Product Overview

AP-SH50 Smart Hub for Z sensors

- Advanced Smart Home Solution
- Zigbee/Zwave Dual Sensor Interface Support
- Smart IP Routing Service Features for Sensor Network
- Smart Wall Pad Interworking Service Features
- Smart Hub Interworking Support for Third Party
- High Performance RISC Programmable Architecture
- One 10/100Mbps Fast Ethernet
- High Performance LAN-to-Zigbee/Zwave Routing Capability
- Powerful Network Protocols (PPPoE, DHCP, Static Routing, etc)
- Firmware Upgradeable Architecture
- Smart Web based Management
- Light and Compact Design with External Power Supply

Hardware Specification

AP-SH50 Smart Hub for Z sensors

- RISC Microprocessor Computing Power
- 1-Port Zigbee Interface
- 1-Port Zwave Interface
- 1-Port Zigbee Antenna
- 1-Port Zwave Antenna
- Network Interface
 - One(1) 10/100Mbps Fast Ethernet (RJ45)
- Run LED, LAN LED, Port LEDs
- External Power Supply



Hardware Specification

AP-SH50 Smart Hub for Z sensors



Smart Hub Service Diagram

AP-SH50 Smart Hub Internal H/W Block Diagram

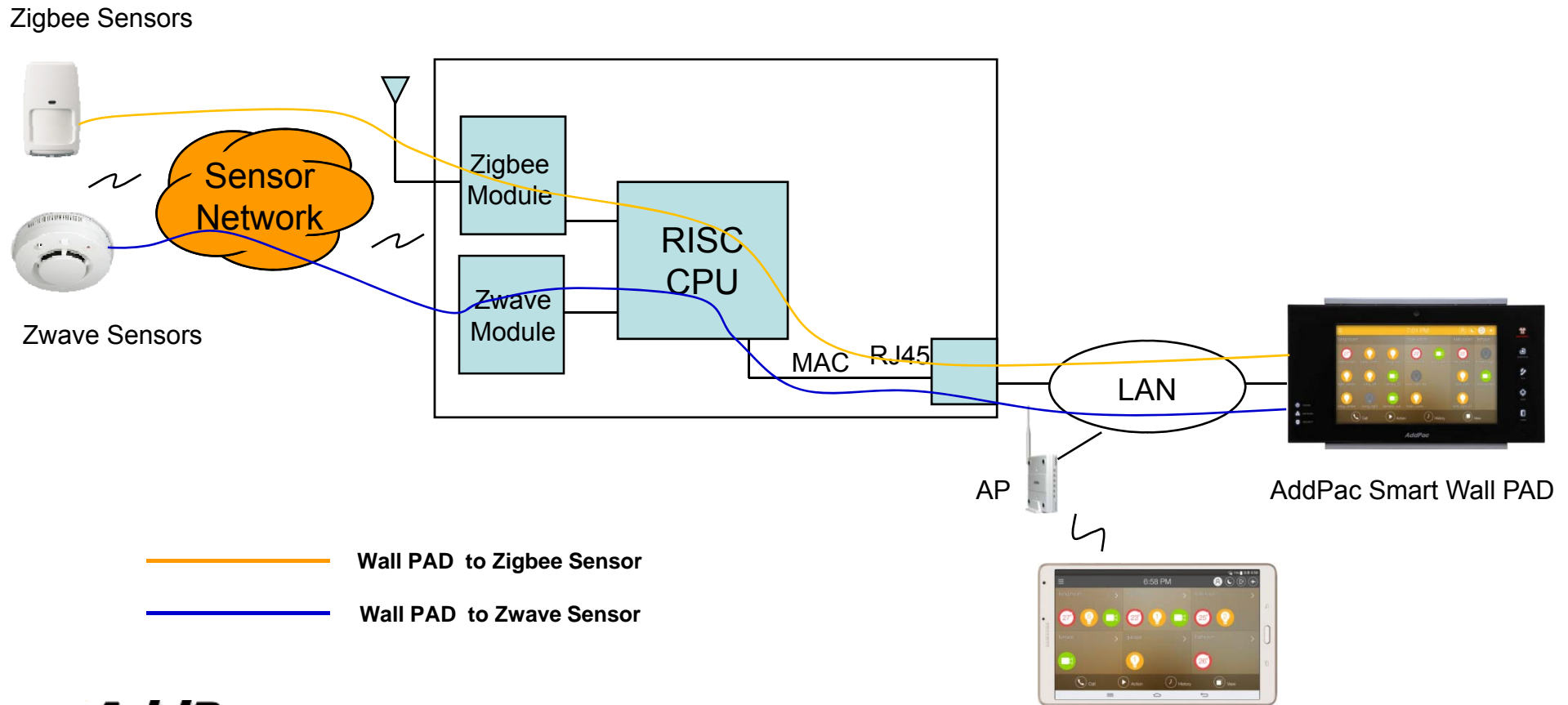

Hardware Specification

AP-SH50ZW Smart Hub for ZWave sensors



Smart Hub Service Diagram

AP-SH50ZW Smart Hub Internal H/W Block Diagram

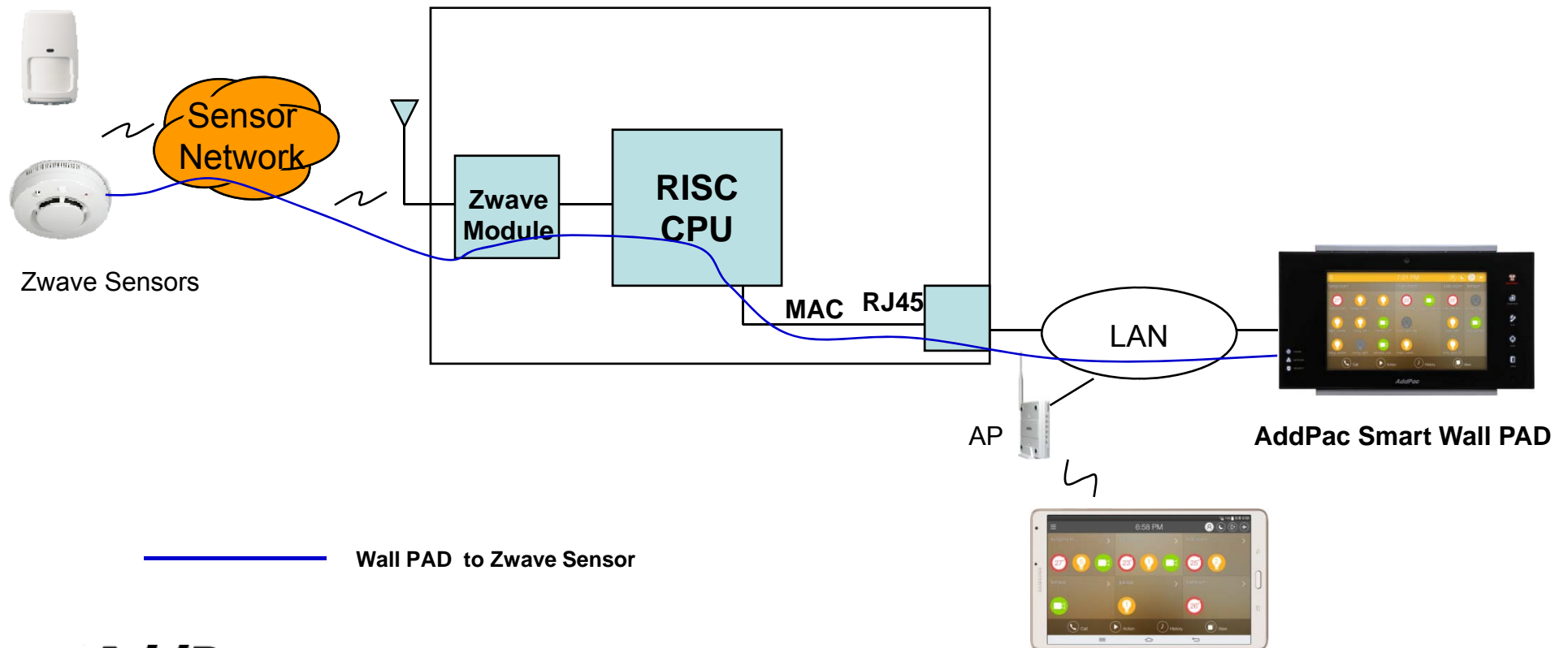

Hardware Specification

AP-SH50ZW Smart Hub for ZWave sensors

Network interface Configurations

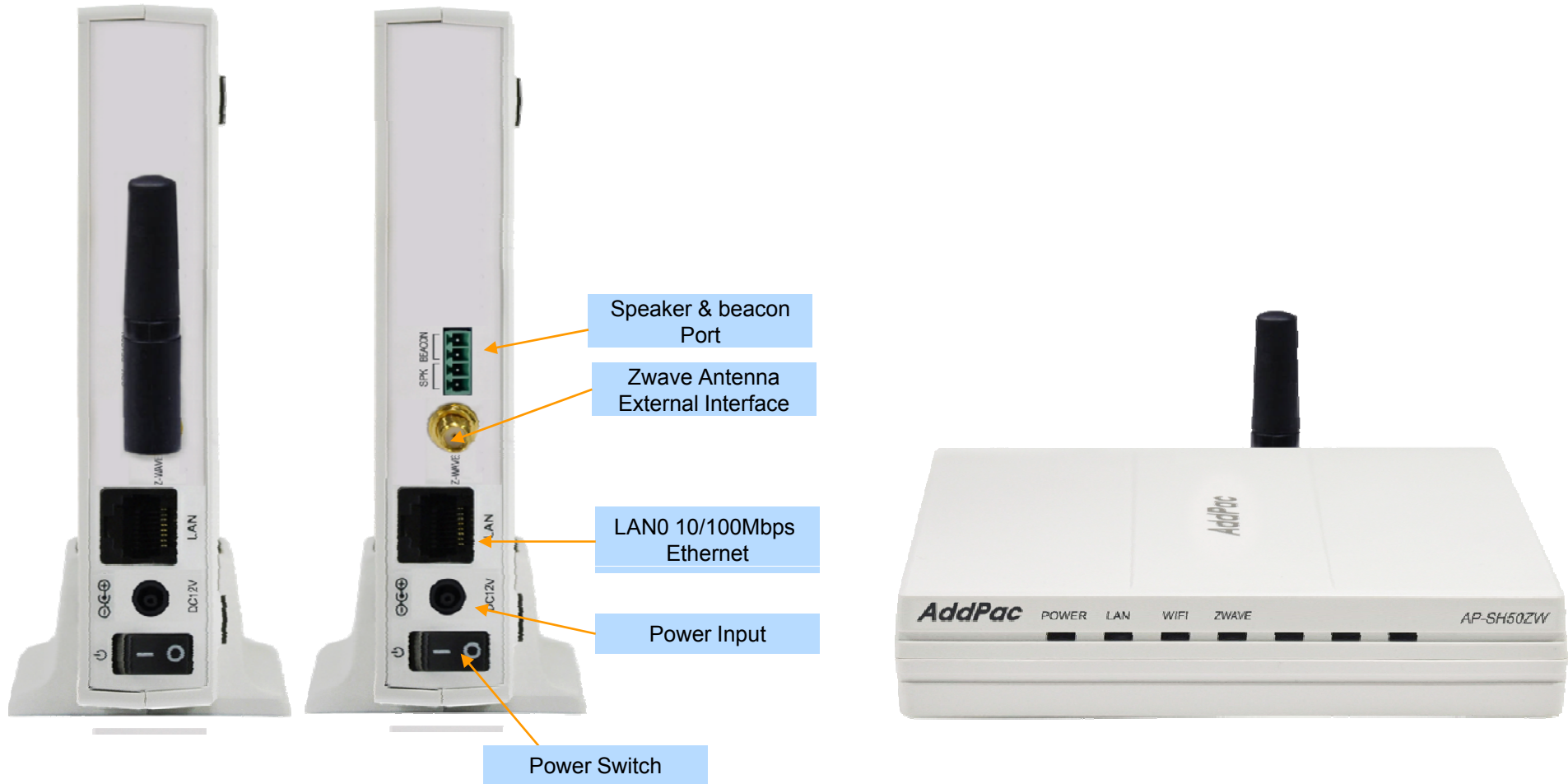

Hardware Specification

AP-SH50 Smart Hub for Z sensors

Network interface Configurations

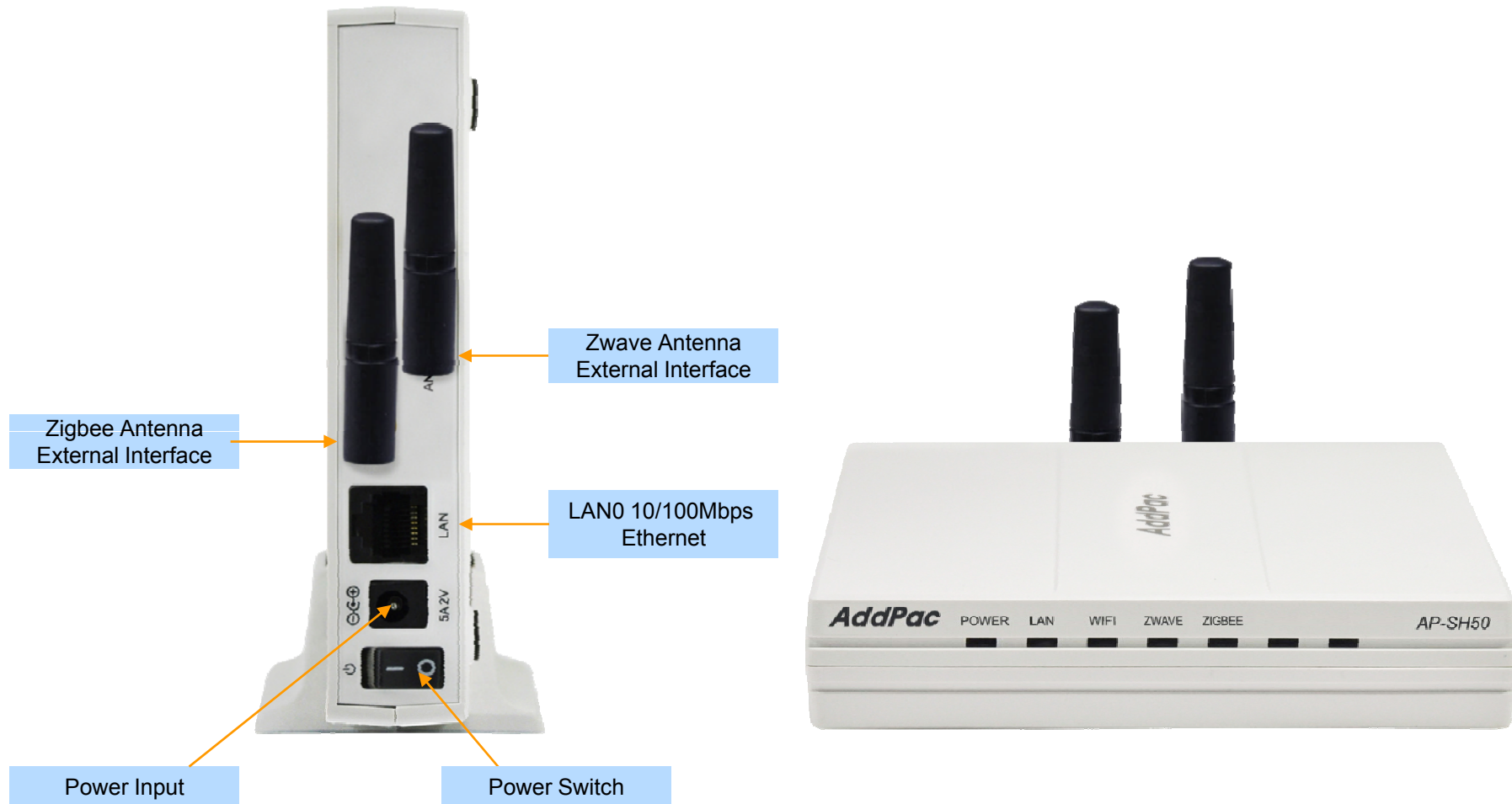



AP-SH50ZW Smart Hub

Product Overview

AP-SH50ZW Smart Hub for ZWave sensors

- Advanced Smart Home Solution
- ZWave Sensor Interface Support
- Smart IP Routing Service Features for Sensor Network
- Smart Wall Pad Interworking Service Features
- Smart Hub Interworking Support for Third Party
- Light SIP Call Manager and RTSP Server & Client Features
- High Performance RISC Programmable Architecture
- One 10/100Mbps Fast Ethernet
- High Performance LAN-to-Zigbee/Zwave Routing Capability
- Powerful Network Protocols (PPPoE, DHCP, Static Routing, etc)
- Firmware Upgradeable Architecture
- Smart Web based Management
- Smart Phone/Tab/PAD Application Software (Android, IOS)
- Light and Compact Design with External Power Supply

Hardware Specification

AP-SH50ZW Smart Hub for ZWave sensors

RISC
CPU

- RISC Microprocessor Computing Power
- 1-Port Zwave Interface
- 1-Port Zwave Antenna
- Speaker & Beacon Port
- Network Interface
 - One(1) 10/100Mbps Fast Ethernet (RJ45)
- Run LED, LAN LED, Port LEDs
- External Power Supply



AP-SAH50 Smart Hub

Product Overview

AP-SAH50 Smart Hub for Legacy Wired Sensors

- Advanced Smart Home Solution
- Legacy Wired Sensor Interface Support
- Smart IP Routing Service Features for Sensor Network
- Smart Wall Pad Interworking Service Features
- Smart Hub Interworking Support for Third Party
- High Performance RISC Programmable Architecture
- One 10/100Mbps Fast Ethernet
- PoE Support : Option
- High Performance LAN-to-Wired Legacy Sensor Routing Capability
- Powerful Network Protocols (PPPoE, DHCP, Static Routing, etc)
- Firmware Upgradeable Architecture
- Smart Web based Management
- Light and Compact Design with External Power Supply

Hardware Specification

AP-SAH50 Smart Hub for Legacy Wired Sensors

- RISC Microprocessor Computing Power
- 6-Port Wired Sensor
 - Alarm Input
 - Power Output for Sensor Power Supply
- Speaker Port, Beacon Port
- Network Interface
 - One(1) 10/100Mbps Fast Ethernet (RJ45)
- LAN LED, Sensor Port LED
- External Power Supply
- PoE (Power over Ethernet) : Option

Hardware Specification

AP-SAH50 Smart Hub for Legacy Wired Sensors

Smart Hub Service Diagram

AP-SH50 Smart Hub Internal H/W Block Diagram

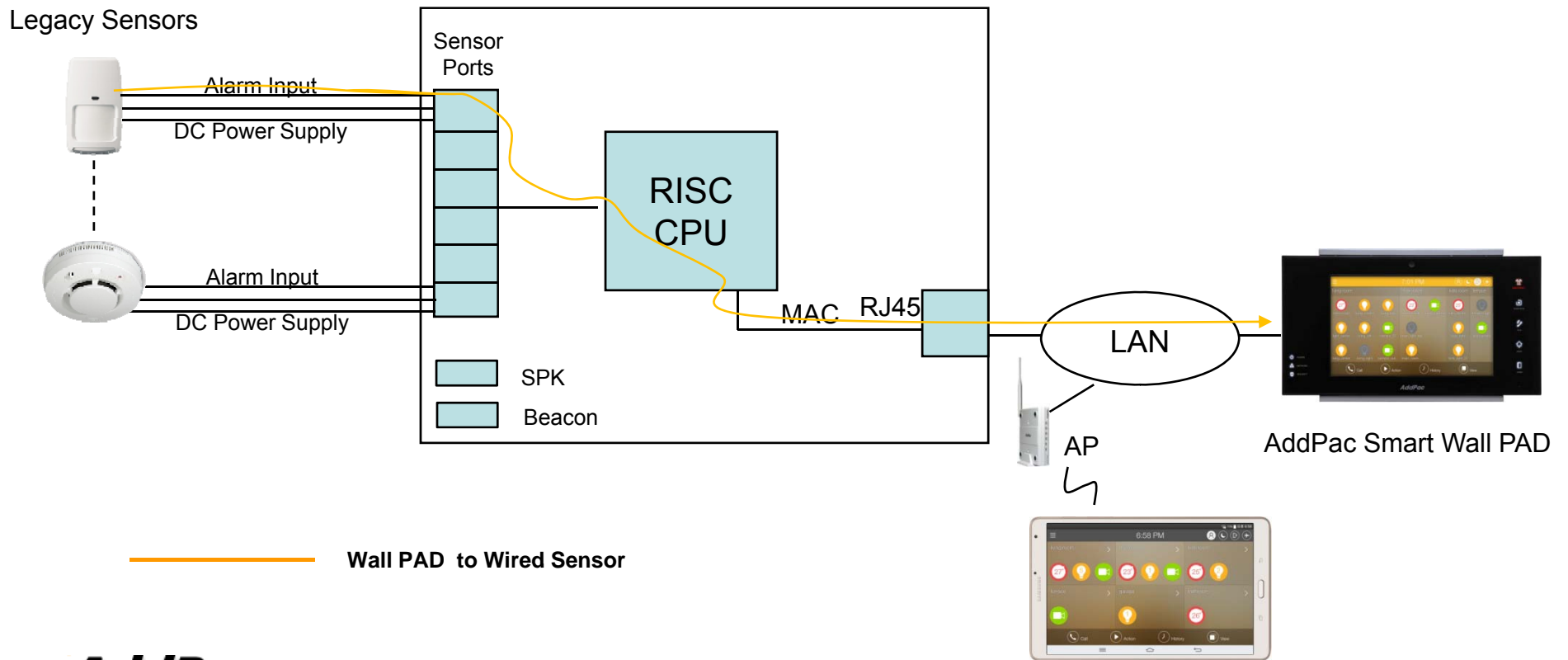

Hardware Specification

AP-SAH50 Smart Hub for Legacy Wired Sensors

Back Side

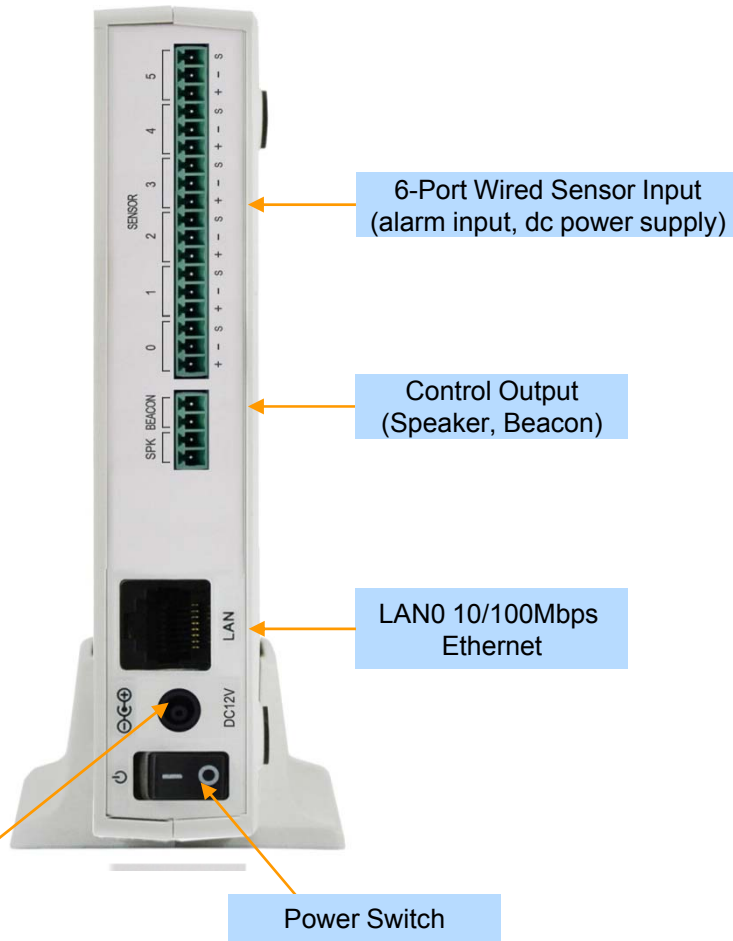

Front Side

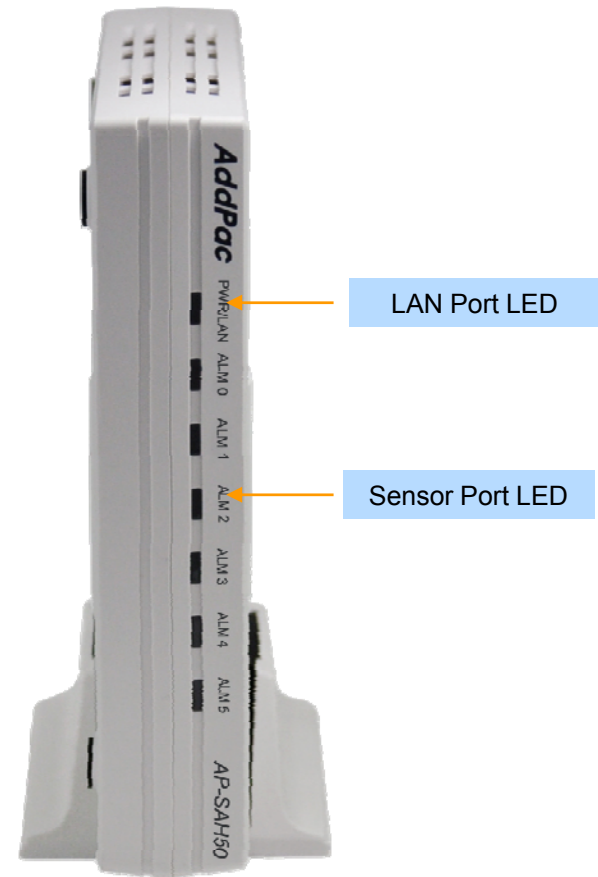



AP-SHD50 Smart Hub

Product Overview

AP-SHD50 Smart Hub for Z Sensors & Wired Sensors

- Advanced Smart Home Solution
- Zigbee/Zwave Dual Sensor Interface Support
- Legacy Wired Sensor Interface Support
- Smart IP Routing Service Features for Sensor Network
- Smart Wall Pad Interworking Service Features
- Smart Hub Interworking Support for Third Party
- High Performance RISC Programmable Architecture
- One 10/100Mbps Fast Ethernet
- PoE Support : Option
- High Performance LAN-to-Zigbee/Zwave Routing Capability
- Powerful Network Protocols (PPPoE, DHCP, Static Routing, etc)
- Firmware Upgradeable Architecture
- Smart Web based Management
- Light and Compact Design with External Power Supply

Hardware Specification

AP-SHD50 Smart Hub for Z Sensors & Wired Sensors

A square logo with a dark blue background and a light blue border. The text "RISC" is positioned above "CPU" in white, bold, sans-serif font.

RISC
CPU

- RISC Microprocessor Computing Power
- 1-Port Zigbee Interface
- 1-Port Zwave Interface
- 6-Port Wired Sensor
 - Alarm Input
 - Power Output for Sensor Power Supply
- Speaker Port, Beacon Port
- Network Interface
 - One(1) 10/100Mbps Fast Ethernet (RJ45)
- LAN LED, Port LEDs
- External Power Supply
- PoE (Power over Ethernet) : Option

Hardware Specification

AP-SHD50 Smart Hub for Z Sensors & Wired Sensors

Smart Hub Service Diagram

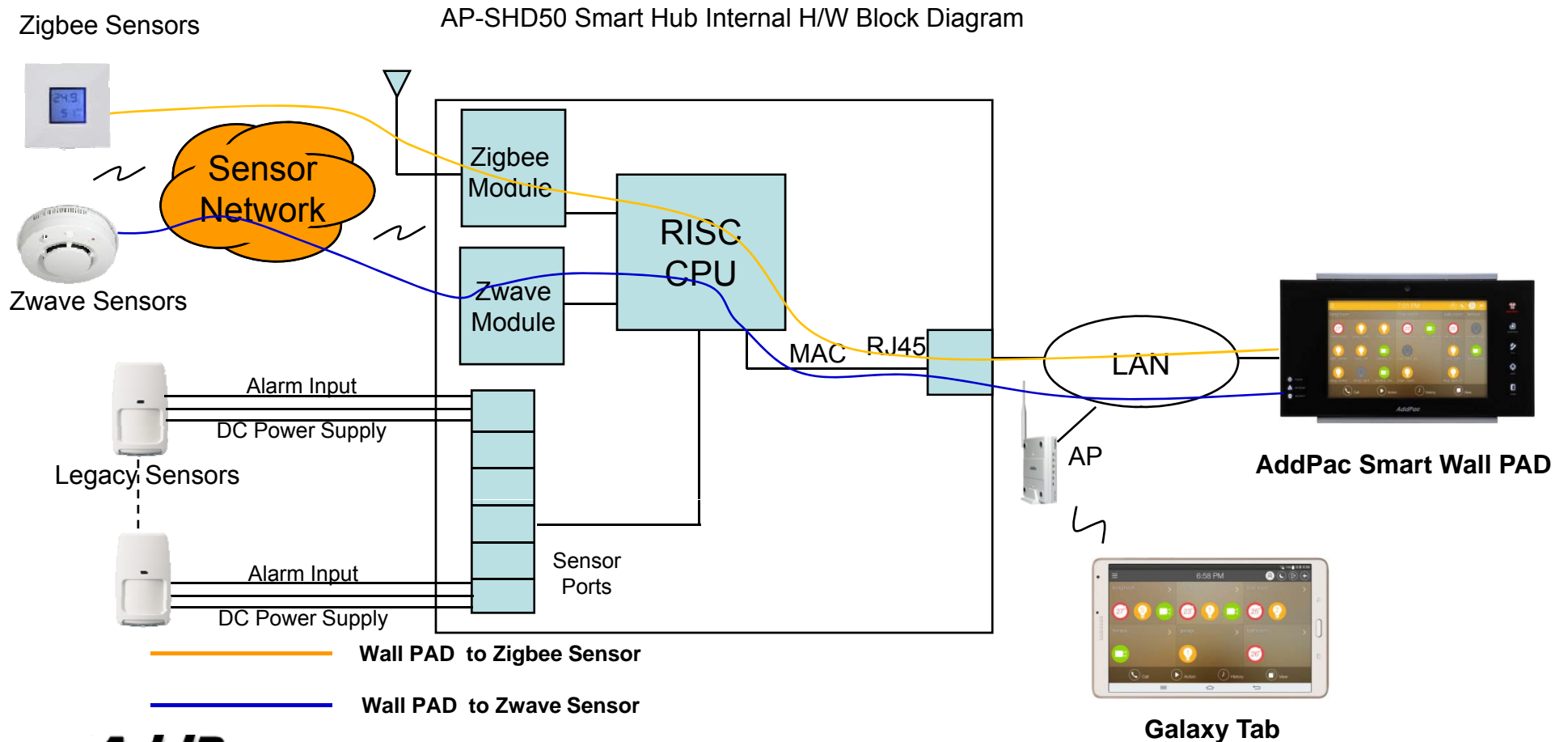

Hardware Specification

AP-SHD50 Smart Hub for Z Sensors & Wired Sensors

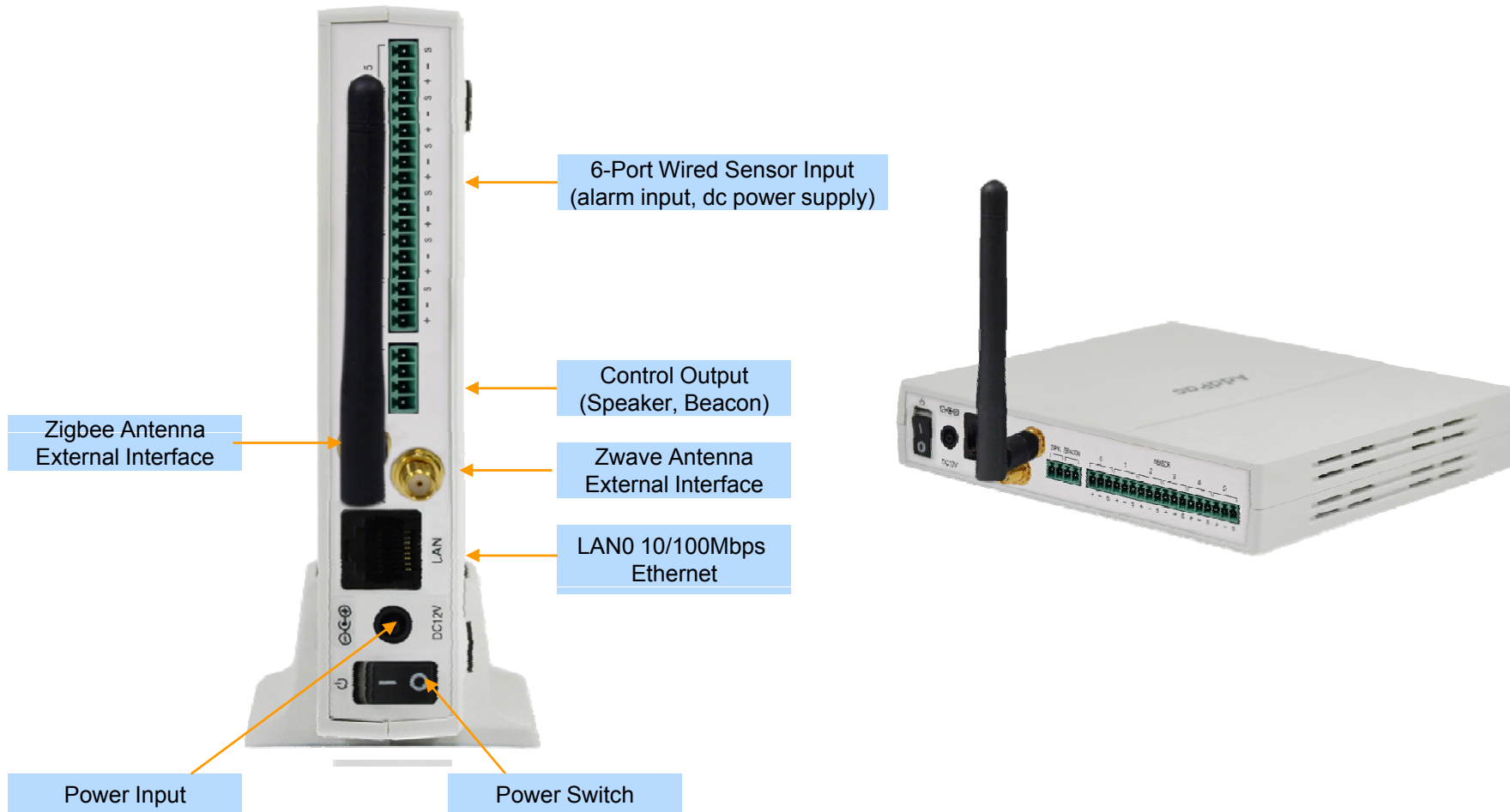

Network interface Configurations





Smart Hub Cloud Devices for Large-Scale Operator

Smart Hub Cloud Equipment Comparison Table

Model	AP-SH20	AP-SH20ZW
Service Features		
Sensor Type	Wireless	Wireless
	ZWave	ZWave
External Zwave Antenna	Support	Support
Smart Appl. for Phone, PAD	Support	Support
Cloud Computing based Smart Web Manager	Support	Support
LAN Port	1 x 10/100Mbps	1 x WiFi Interface
PoE(Optional)	Option	N/A

Product Overview

AP-SH20 Smart Hub Cloud for ZWave sensors

- Cloud based Advanced Smart Home Solution
- ZWave Sensor Interface Support
- External ZWave Antenna Support for Performance
- Smart IP Routing Service Features for Sensor Network
- High Performance RISC Programmable Architecture
- One 10/100Mbps Fast Ethernet or WiFi LAN Interface
- High Performance LAN-to-ZWave Routing Capability
- Cloud Server based Smart Web based Management
- Cloud Server based Smart Phone/Tab/Pad Application Software
- Light and Compact Design with External Power Supply

Hardware Specification

AP-SH20 Smart Hub Cloud for ZWave sensors

RISC
CPU

- RISC Microprocessor Computing Power
- 1-Port ZWave Interface
- 1-Port ZWave Antenna
- Network Interface
 - AP-SH20 : One(1) 10/100Mbps Fast Ethernet (RJ45)
 - AP-SH20W : One(1) WiFi LAN Interface with Antenna
- Run LED, LAN LED, Port LEDs
- External Power Supply

Hardware Specification

AP-SH20 Smart Hub Cloud for ZWave sensors

RISC
CPU

Smart Hub Service Diagram

AP-SH20 Smart Hub Internal H/W Block Diagram

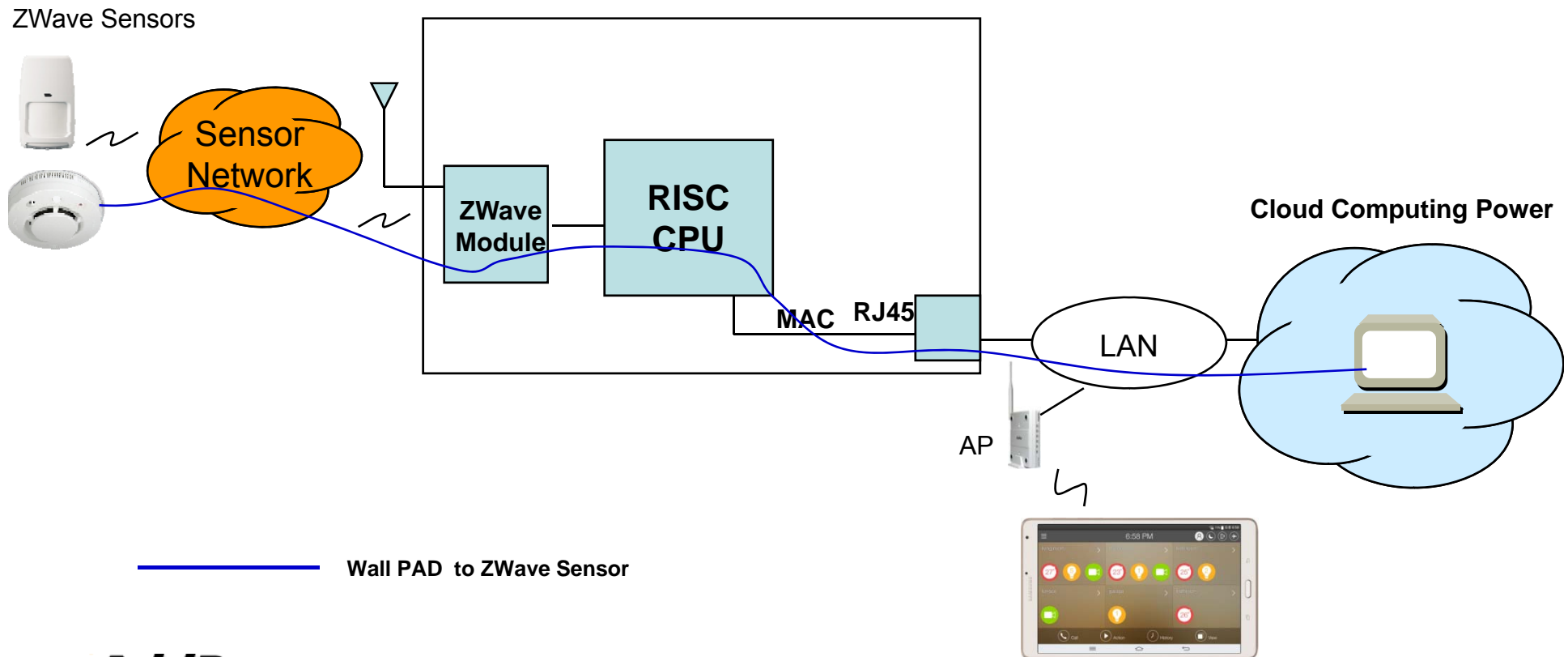

Hardware Specification

AP-SH20 Smart Hub Cloud for ZWave sensors

AP-SH20 Network interface Configurations

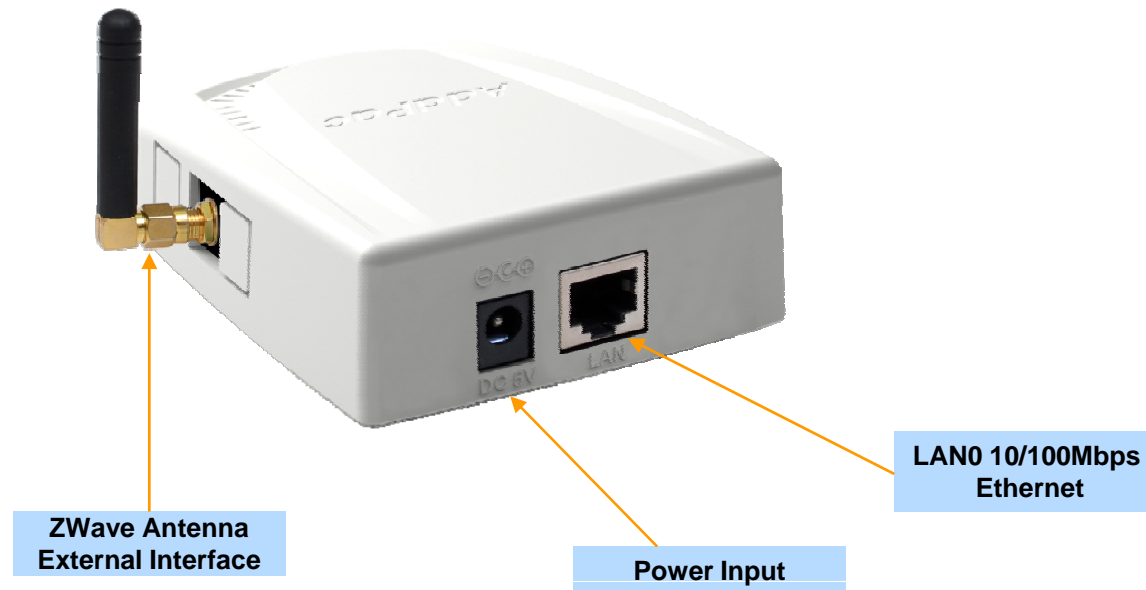

Hardware Specification

AP-SH20 Smart Hub Cloud for ZWave sensors

AP-SH20W Network interface Configurations

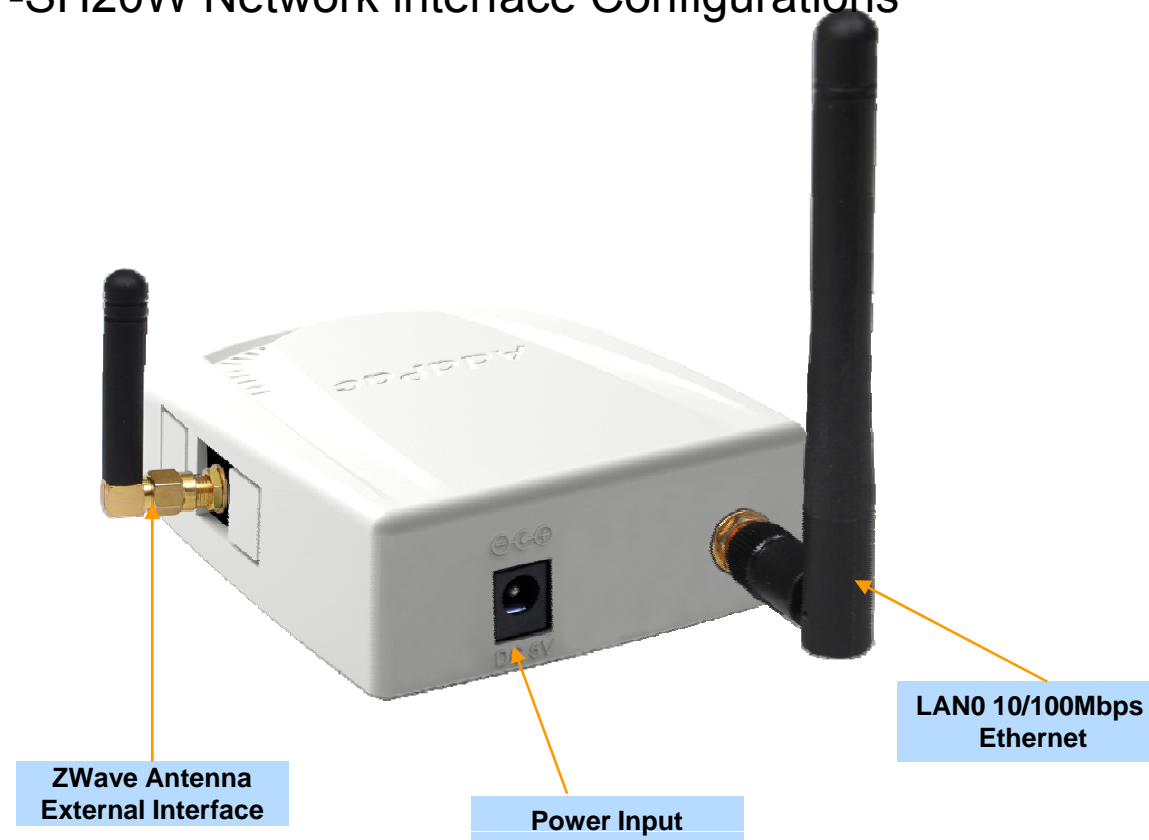

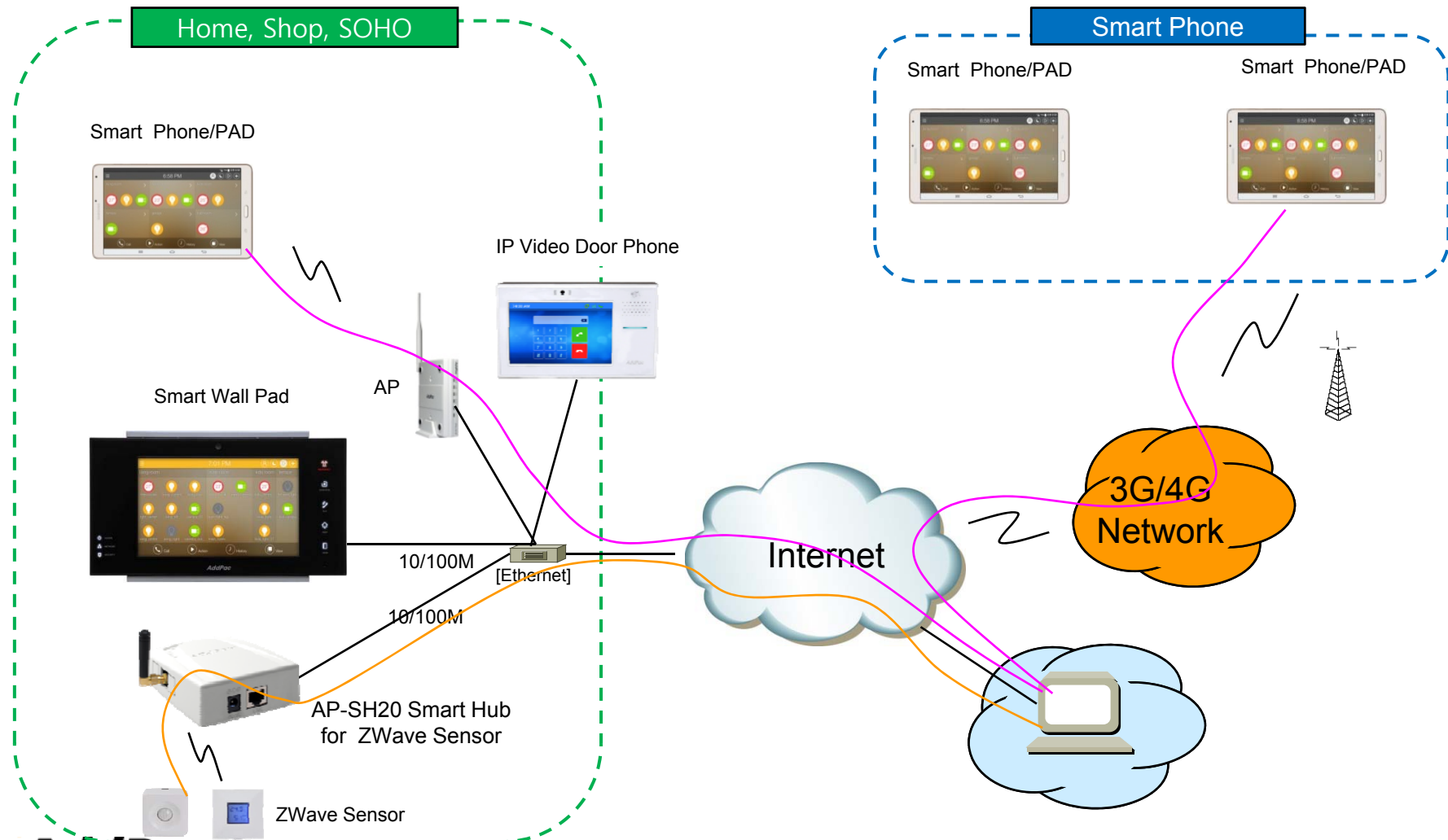

Standard Application





Enterprise Smart Hub Device AP-SH1000

Enterprise Smart Hub Device Comparison Table

AP-SH1000 Module	AP-ZBW100	AP-ZW100	AP-ZW104
Specification			
ZigBee Interface	Support	N/A	N/A
ZigBee Antenna	1	N/A	N/A
ZWave Interface	Support	Support	Support
ZWave Antenna	1	1	4
Network Interface	10/100Mbps Fast Ethernet	10/100Mbps Fast Ethernet	10/100Mbps Fast Ethernet
RS232C Console	1	1	1
Speaker & Beacon Port	Support	Support	Support

Product Overview

AP-SH1000 Enterprise Smart Hub for Z sensors

- Advanced Smart Enterprise Solution
- Zigbee/Zwave Dual Sensor Interface Support
- Smart IP Routing Service Features for Sensor Network
- AddPac IoT Solution Interworking Service Features
- Smart Hub Interworking Support for Third Party
- Module Type Hardware Architecture for Flexibility and Scalability
- High Performance RISC Programmable Architecture
- One 10/100Mbps Fast Ethernet
- External Antenna Support for Zwave/ZigBee Sensor Device
- High Performance LAN-to-Zigbee/Zwave Routing Capability
- Powerful Network Protocols (PPPoE, DHCP, Static Routing, etc)
- Firmware Upgradeable Architecture
- Smart Web based Management
- Light and Compact Design with External Power Supply

Hardware Specification

AP-SH1000 Enterprise Smart Hub for Z sensors

RISC
CPU

- RISC Microprocessor Computing Power
- Z Sensor Interface Modules
 - AP-ZBW100 : ZigBee and ZWave Dual Interface
 - AP-ZW100 : ZWave Interface, One(1) Antenna
 - AP-ZW104 : Zwave Interface, Four(4) Antenna
- Speaker & Beacon Port
- Network Interface
 - One(1) 10/100Mbps Fast Ethernet (RJ45)
- One(1) RS232C Console Port
- Run LED, LAN LED, etc
- External Power Supply

Hardware Specification

AP-SH1000 Enterprise Smart Hub for Z sensors



Smart Hub Service Diagram

AP-SH1000 Enterprise Smart Hub Internal H/W Block Diagram

Zigbee Sensors

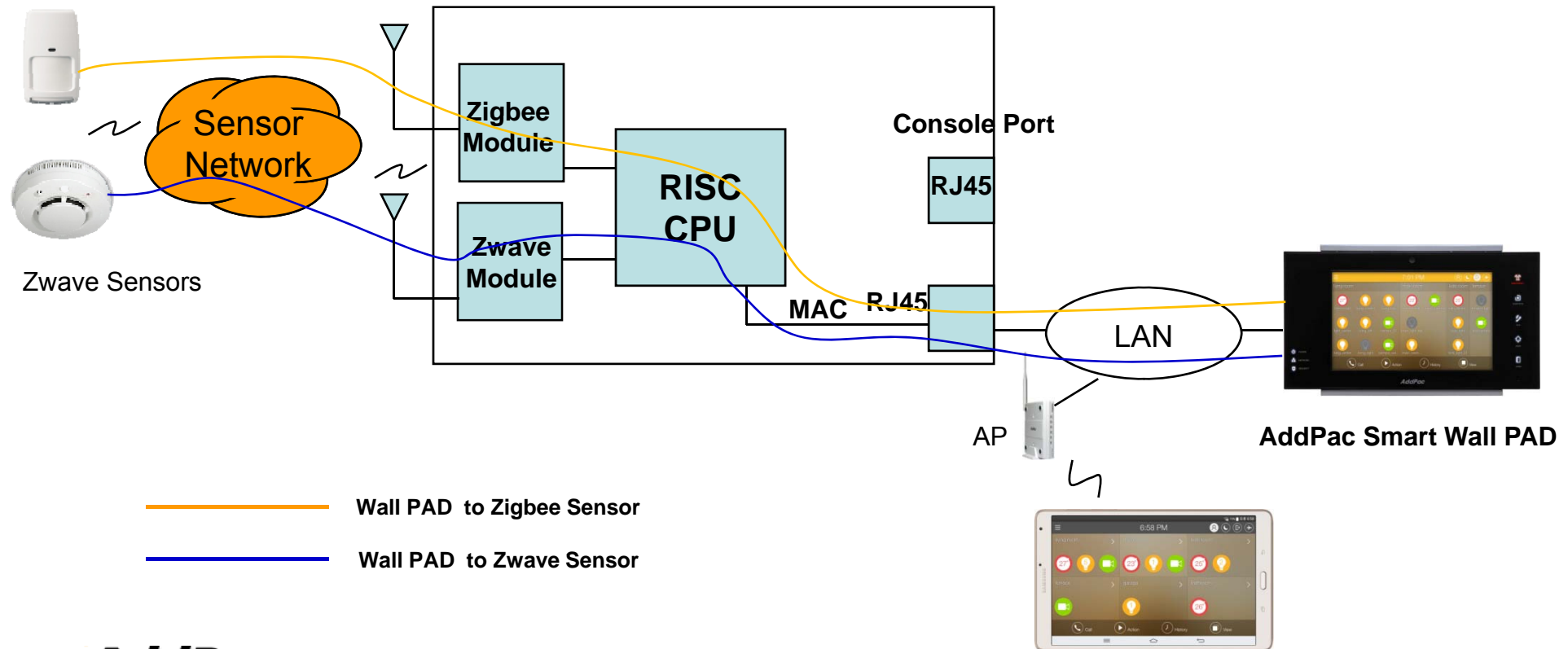

Hardware Specification

AP-SH1000 Enterprise Smart Hub for Z sensors

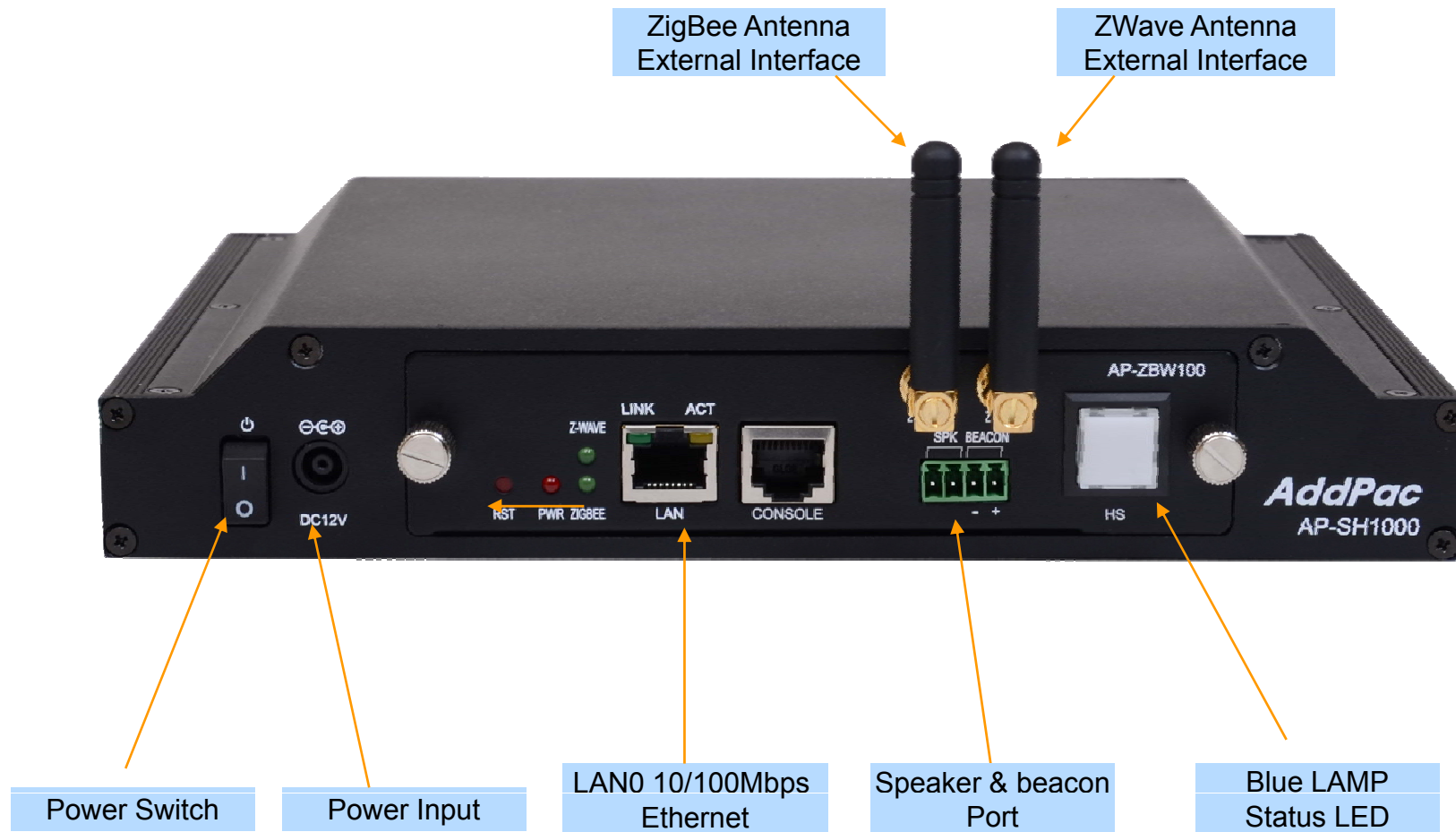



Smart Sensor Network Controller AP-SNC2000

Product Overview

AP-SNC2000 Smart Sensor Network Controller

- Embedded H/W Platform with Dual CPU Module Slots
- Fault Tolerant and Reliability Service
- Support Multiple Smart Hub for Zigbee/Zwave sensors
- Support RTSP based Network Video Encoder (Video Codec, IP Camera, etc) Control
- Support RTP based Video Door Phone Control
- Mini Call Manager Function Support for Smart Phone, Tab/PAD registration
- Load Balance using RTSP Redirect Service
- Web Server Function for Smart Tab, Smart Phone Appl.

Hardware Specification

AP-SNC2000 Smart Sensor Network Controller

High-end
RISC

- High-end Programmable RISC Hardware Architecture
- Two(2) Module Slots for Redundancy and Load Balance
- Smart Sensor Network Control Module (AP-SNCM)
 - Network Interface
 - Two(2) 10/100/1000Mbps Gigabit Ethernet
 - One(1) Console Port



Hardware Specification

AP-SNC2000 Smart Sensor Network Controller

High-end
RISC

AP-SNC2000 Front View



Sensor Network Controller Module



Hardware Specification

AP-SNC2000 Smart Sensor Network Controller



AP-SNCM Sensor Network Control Module

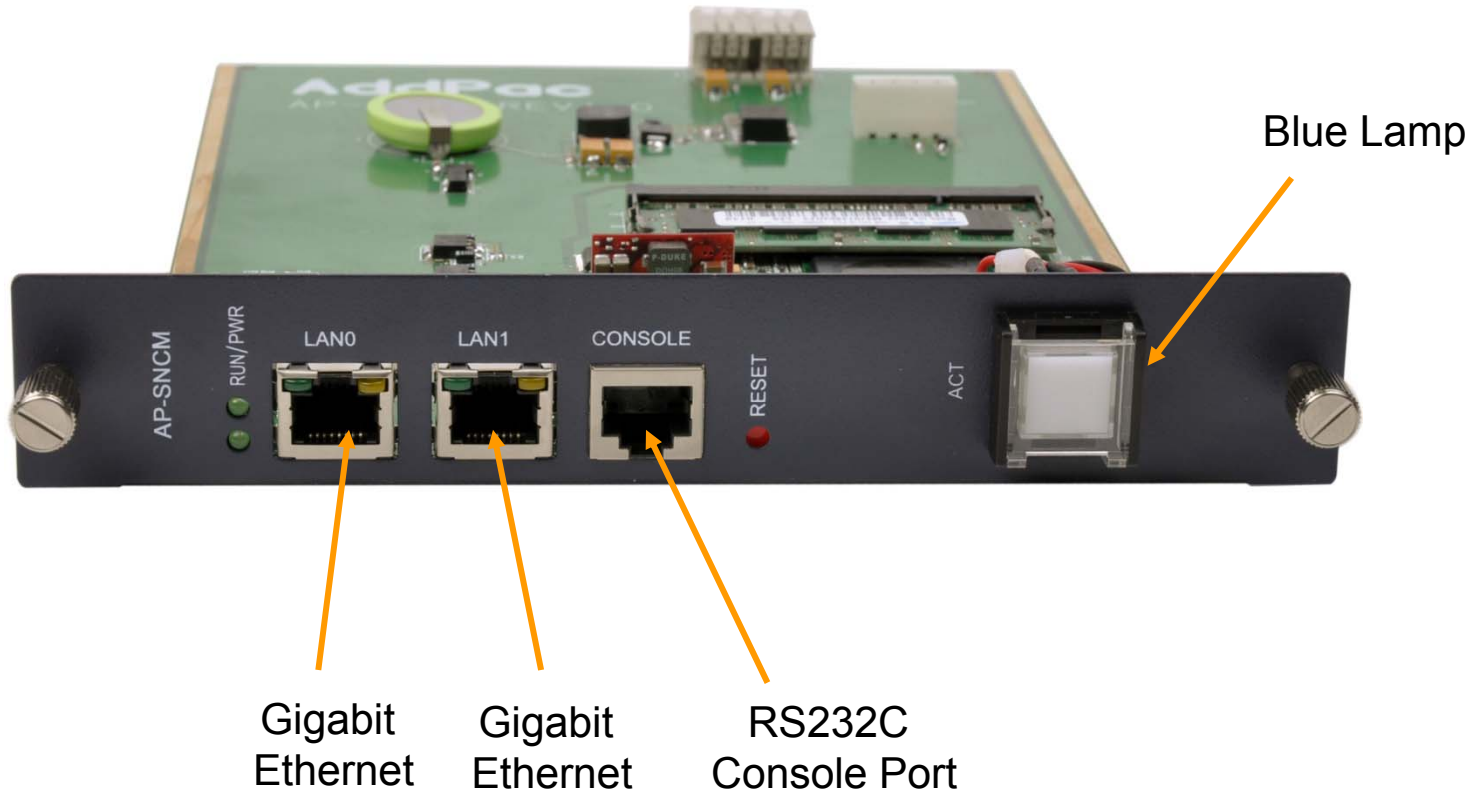

Gigabit Ethernet

Gigabit Ethernet

RS232C Console Port

Blue Lamp

Standard Application

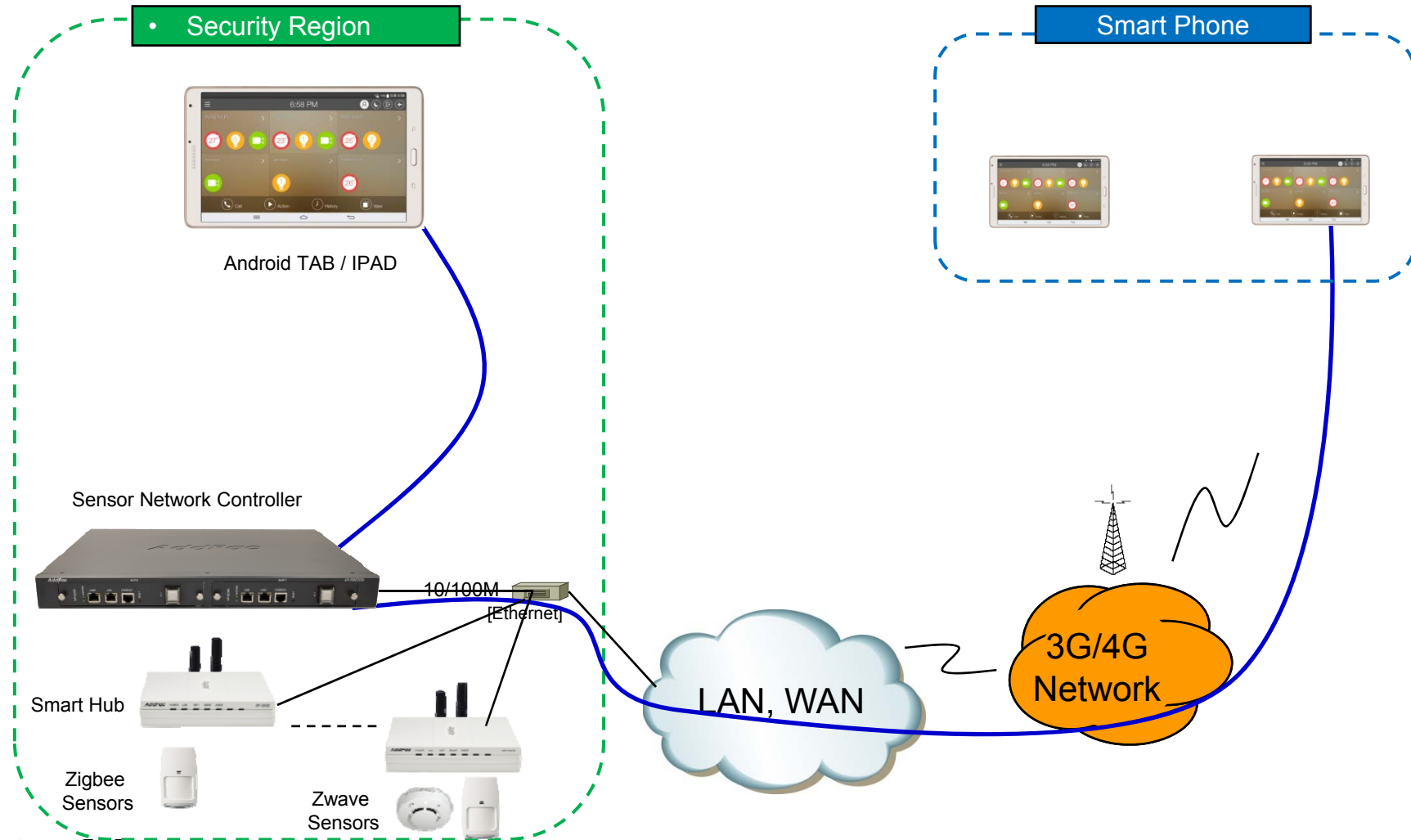

Supplementary Application

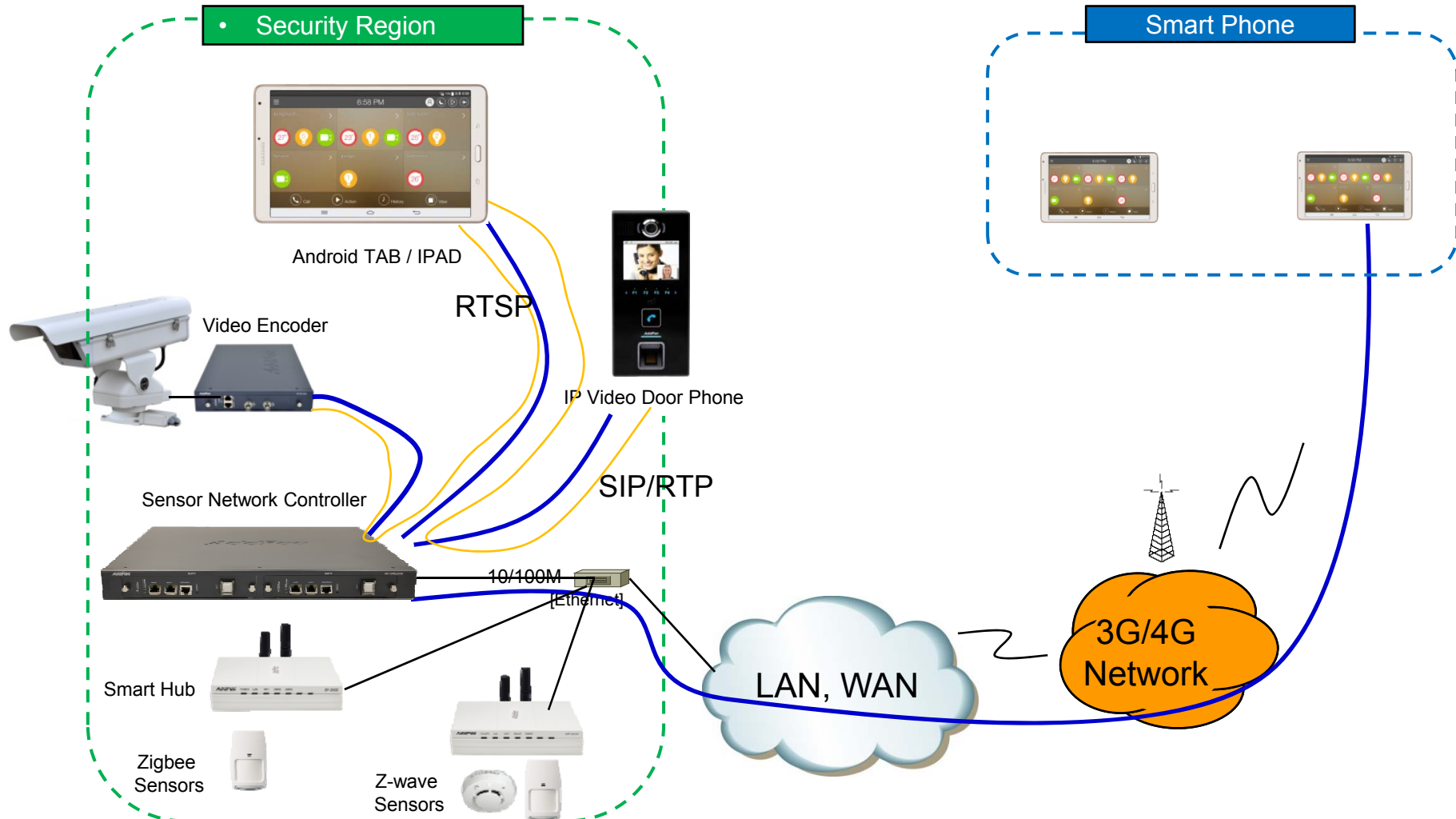

Smart Hub Control PAD AP-SHC300 (Smart Hub + Wall PAD)



AddPac

www.addpac.com

Product Overview

AP-SHC300 Smart Hub Control PAD for Z sensors

- High Performance Smart Hub Control PAD Solution for ZigBee/Zwave Sensor Devices
- Advanced Enterprise Sensor Device Control Solution
- ZigBee/Zwave Dual Sensor Interface Support
- Smart IP Routing Solution for Sensor Network
- Smart Hub + Control PAD Hybrid Solution
- TFT Color LCD, Touch Screen, Touch Sensor, Internal MIC & Speaker
- High Quality “7 Inch LCD, 800x480 Video Resolution
- Network Interface
 - One(1) 10/100Mbps Fast Ethernet
 - One(1) USB 2.0 Interface for External WiFi USB Module (Option)
- PoE(Power over Ethernet) or Internal SMPS Power Support (Option)
- Powerful Network Protocols (PPPoE, DHCP, Static Routing, etc)
- Firmware Upgradeable Architecture
- Advanced Voice QoS Mechanism

Hardware Specification

AP-SHC300 Smart Hub Control PAD for Z Sensors

- RISC+DSP Microprocessor Computing Power
- Audio and Voice Interface
 - Internal MIC
 - Internal Speaker
- TFT Color LCD Interface with Touch Screen
 - 7 Inch LCD, 800 x 480, D1 Video Resolution
- 1-Port ZigBee Interface + External Antenna
- 1-Port ZWave Interface + External Antenna
- Network Interface
 - One(1) 10/100Mbps Fast Ethernet
 - One(1) USB 2.0 Interface for External WiFi USB Module (Option)
- Wall Mount
- Power Supply
 - Power over Ethernet (Option)
 - Internal SMPS Power (Option)
 - External Power Adaptor (Default)

Hardware Specification

AP-SHC300 Smart Hub Control PAD for Z Sensors

Front Side



7inch
TFT LCD Display
with Touch
Screen

Internal MIC Input

Hardware Specification

AP-SHC300 Smart Hub Control PAD for Z Sensors

Back Side

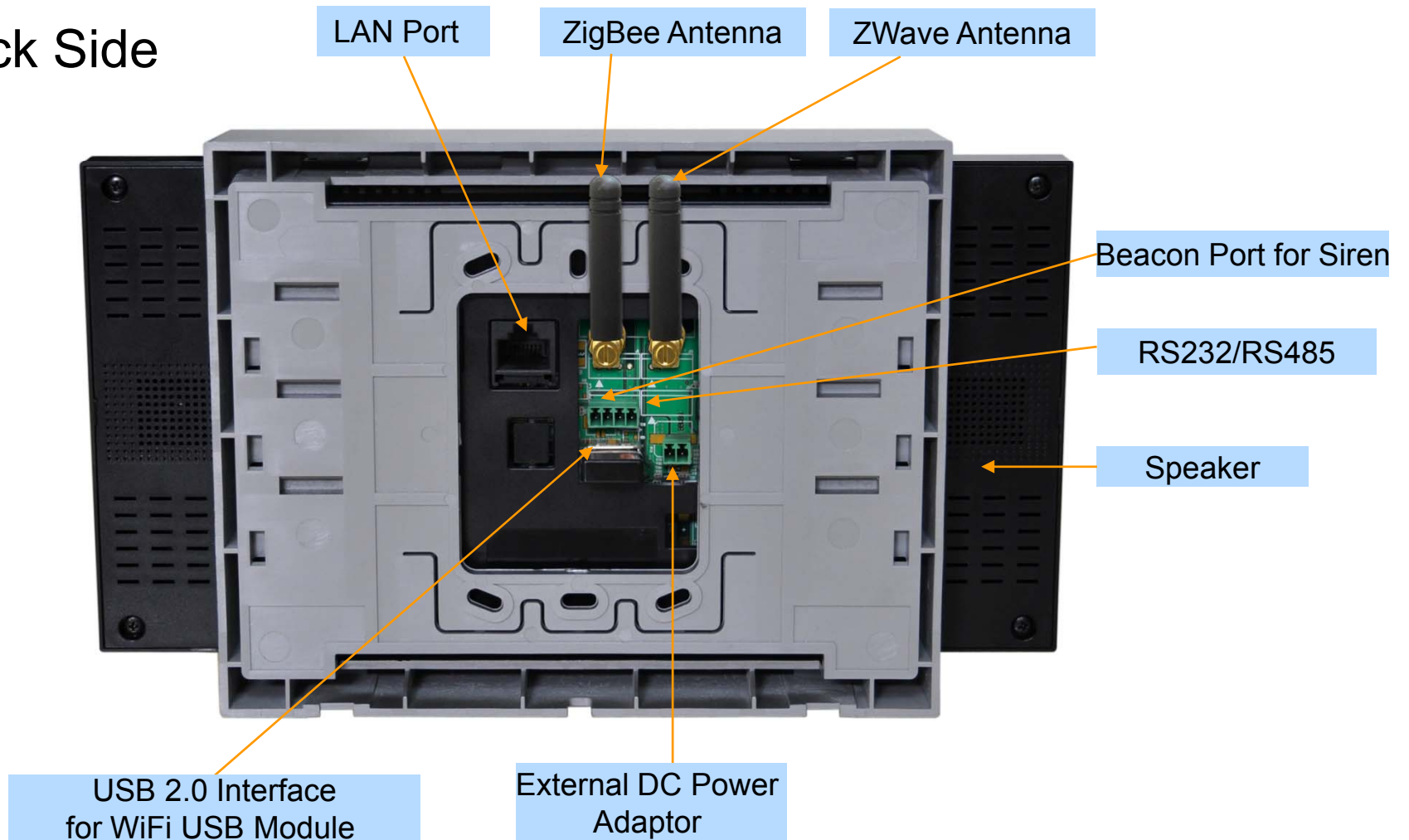

Sensor Control Wall PAD AP-SWP100



AddPac

www.addpac.com

Product Overview

AP-SWP100 Sensor Control Wall PAD

- High Performance Sensor Control Wall PAD Solution for ZigBee/Zwave Sensor Devices
- Advanced Enterprise Sensor Device Control Solution
- Interworking with AddPac Smart Sensor Network Controller
- TFT Color LCD, Touch Screen, Internal MIC & Speaker
- High Quality “7 Inch LCD, 800x480 Video Resolution
- Network Interface
 - One(1) 10/100Mbps Fast Ethernet
 - One(1) USB 2.0 Interface for External WiFi USB Module (Option)
- PoE(Power over Ethernet) or Internal SMPS Power Support (Option)
- Powerful Network Protocols (PPPoE, DHCP, Static Routing, etc)
- Firmware Upgradeable Architecture

Hardware Specification

AP-SWP100 Sensor Control Wall PAD

- RISC+DSP Microprocessor Computing Power
- Audio and Voice Interface
 - Internal MIC
 - Internal Speaker
- TFT Color LCD Interface with Touch Screen
 - 7 Inch LCD, 800 x 480, D1 Video Resolution
- Network Interface
 - One(1) 10/100Mbps Fast Ethernet
 - One(1) USB 2.0 Interface for External WiFi USB Module (Option)
- Wall Mount
- Power Supply
 - Power over Ethernet (Option)
 - Internal SMPS Power (Option)
 - External Power Adaptor (Default)

Hardware Specification

AP-SWP100 Sensor Control Wall PAD

Front Side



7inch
TFT LCD Display
with Touch
Screen

Internal MIC Input

Hardware Specification

AP-SWP100 Sensor Control Wall PAD

Back Side

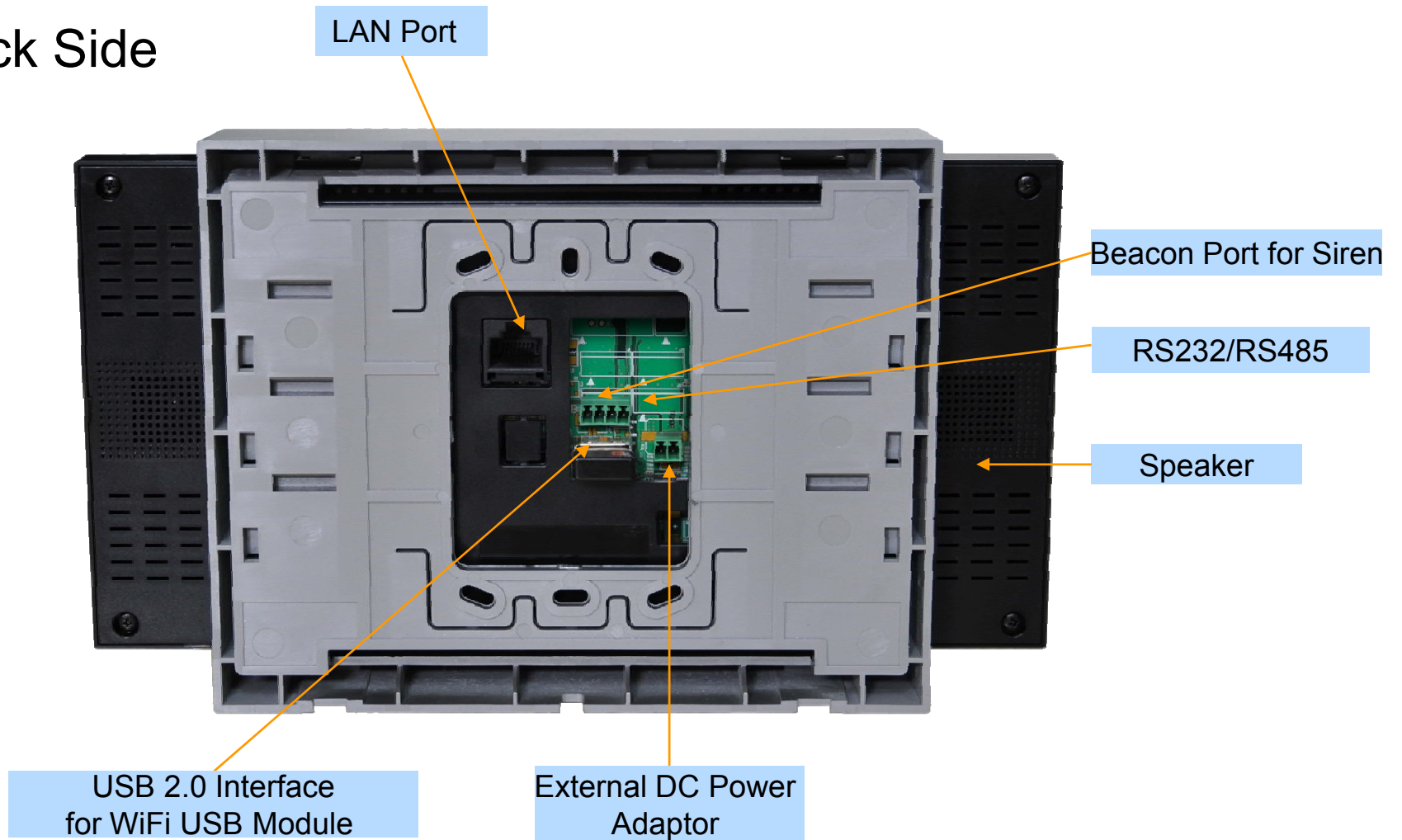

AP-SWP100 IP Sensor Control Wall PAD for Z Sensors : Standard Application

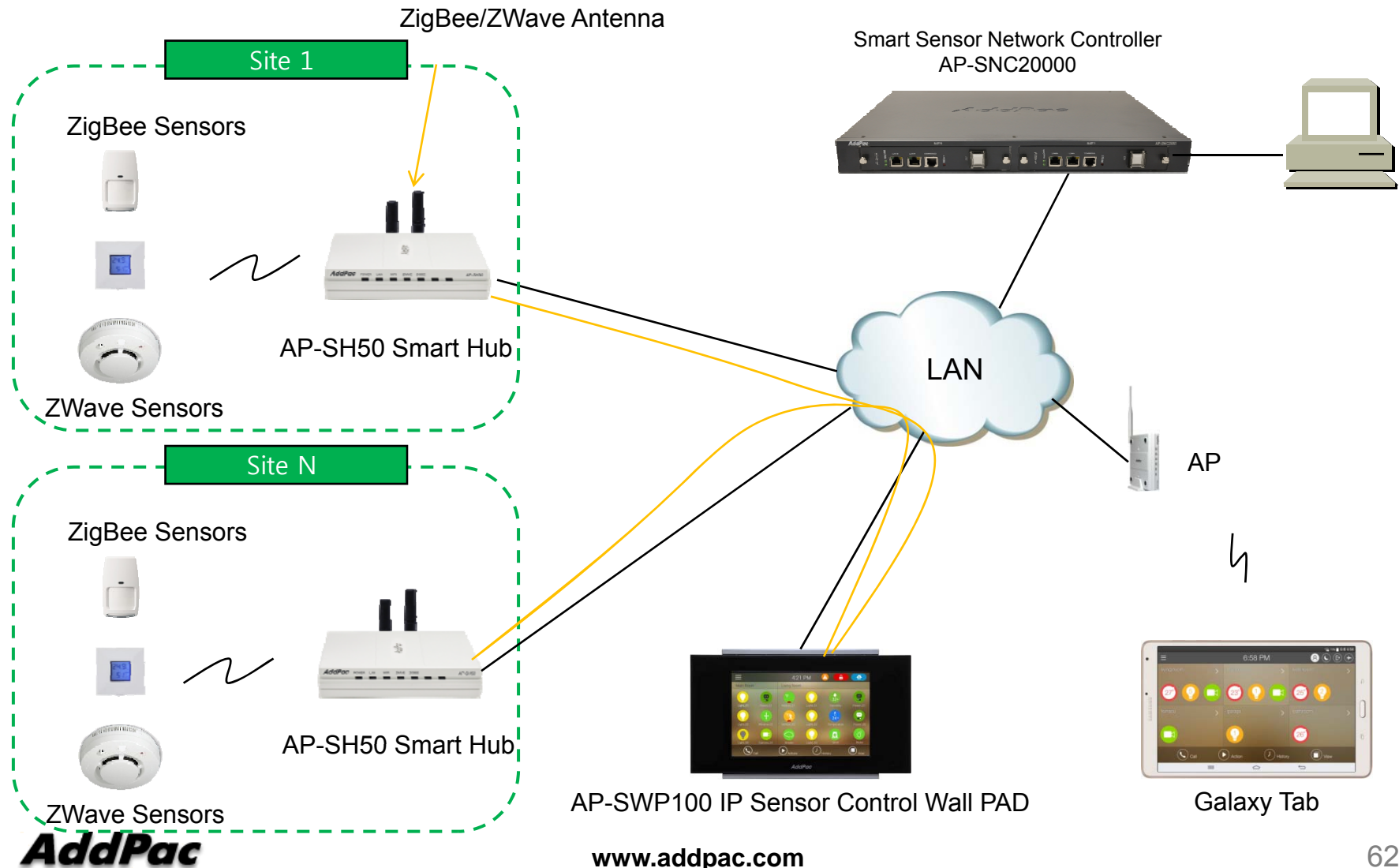

AP-SWP100 Smart Hub Control PAD for Z Sensors : Large Scale Application

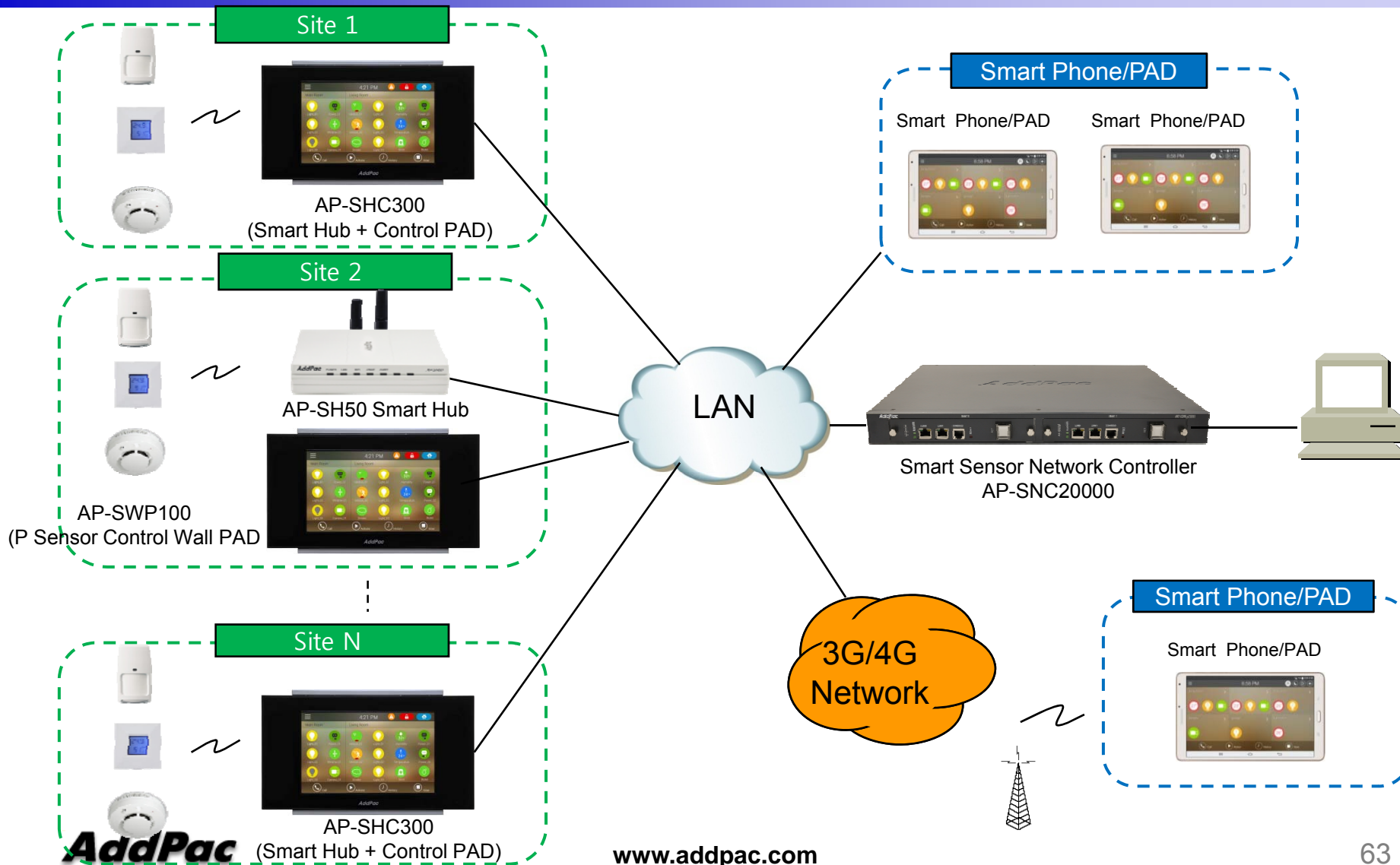

Android Smart Home Application Software (AP-ASH100)



AP-ASH100 Overview

- It supports receiving a video call from video door phone by visitor.
- It supports making a video call to video door phone to see door side.
- It supports bidirectional video call from security guard video phone.
- It supports smart hub devices for sensor device handling.
- It supports IP camera view mode using RTSP protocol
- It supports standard based SIP signaling protocol.
- It supports below voice and video codecs
 - Voice Codec : G.711ulaw/alaw, G.726
 - Video Codec : H.264, H.263. MPEG4

AP-ASH100 Network Service Diagram

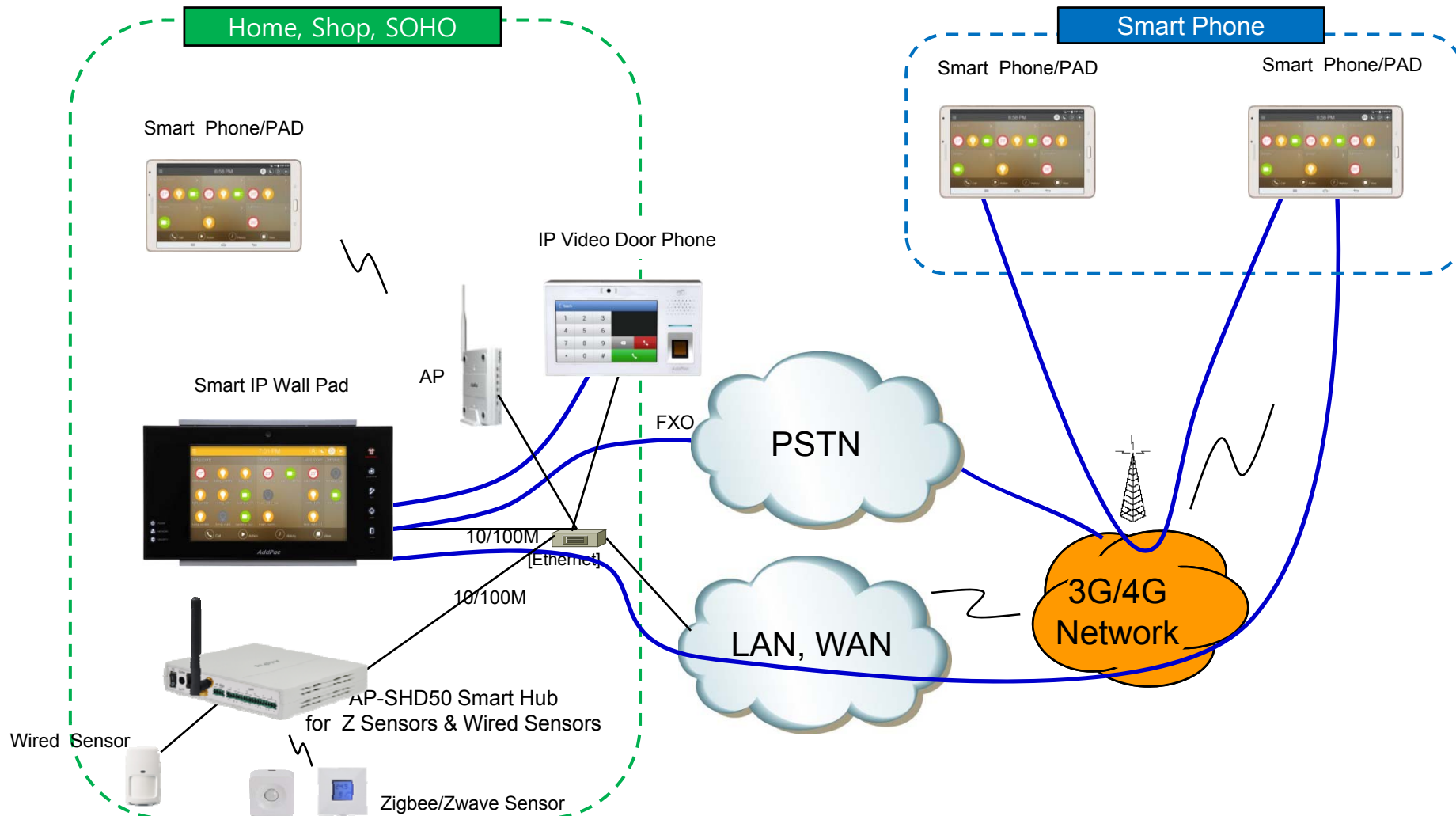

SIP Register

Smart Home Application Register to AP-ACS1000

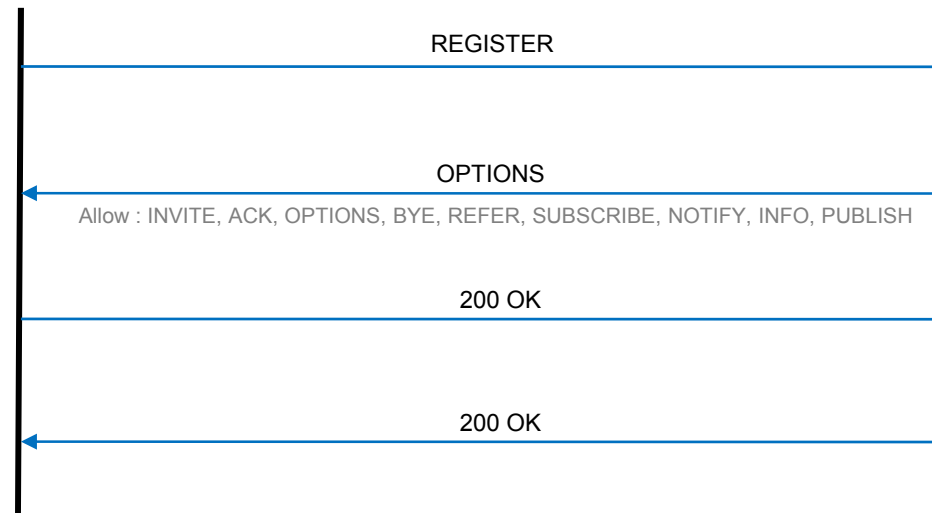
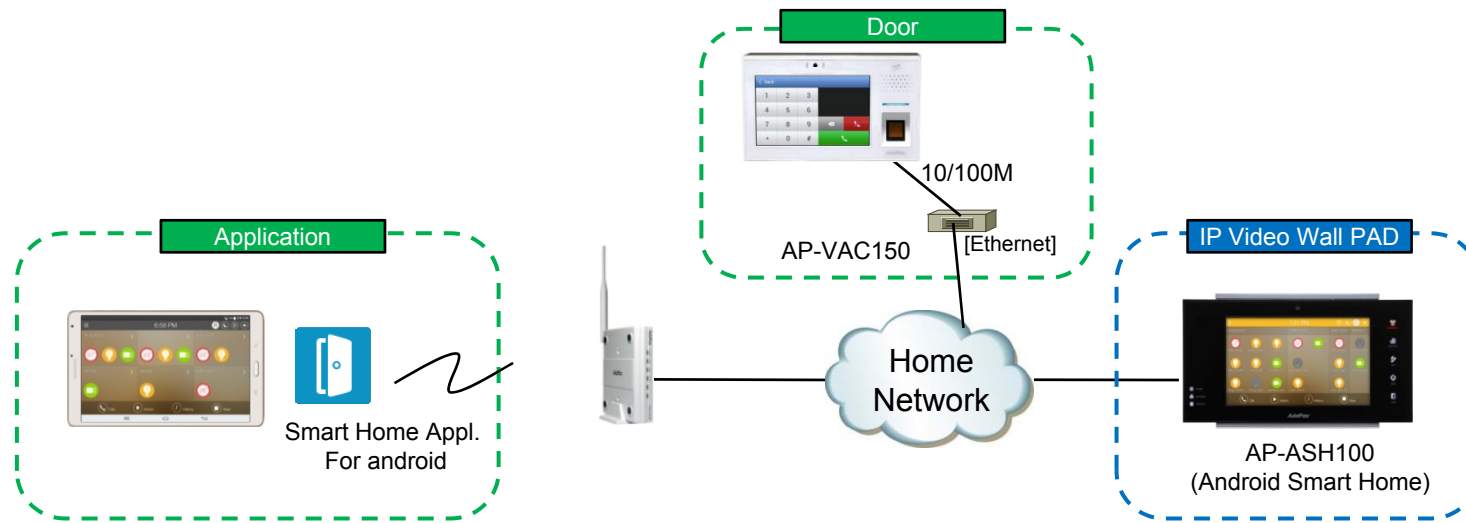

SIP Video Call Flow

Door Open Flow

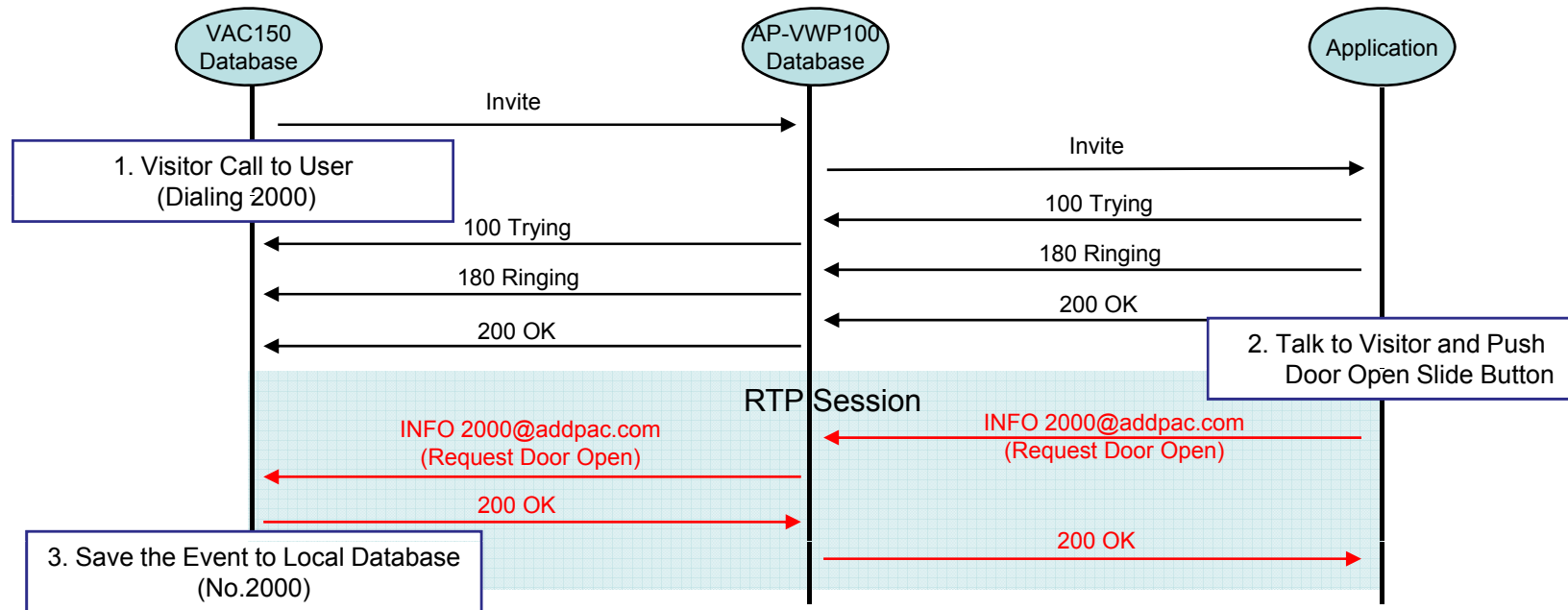

UI examples Lists

- Main View (Zone Summary)
- Armed Mode (Away, Stay, Night)
- Short View
- Zone View
- Zone Setting and Configuration
- IP Camera View Mode (Home, Outside Home)
- Call View (Favorite Call, Recent Call, Phone Book, etc)
- Video Call View
- Sensor Control View (Ex: Light Control, Thermostat, etc)
- Sensor Control View (Action, Mode, Alert, etc)

Main View (Zone Summary)

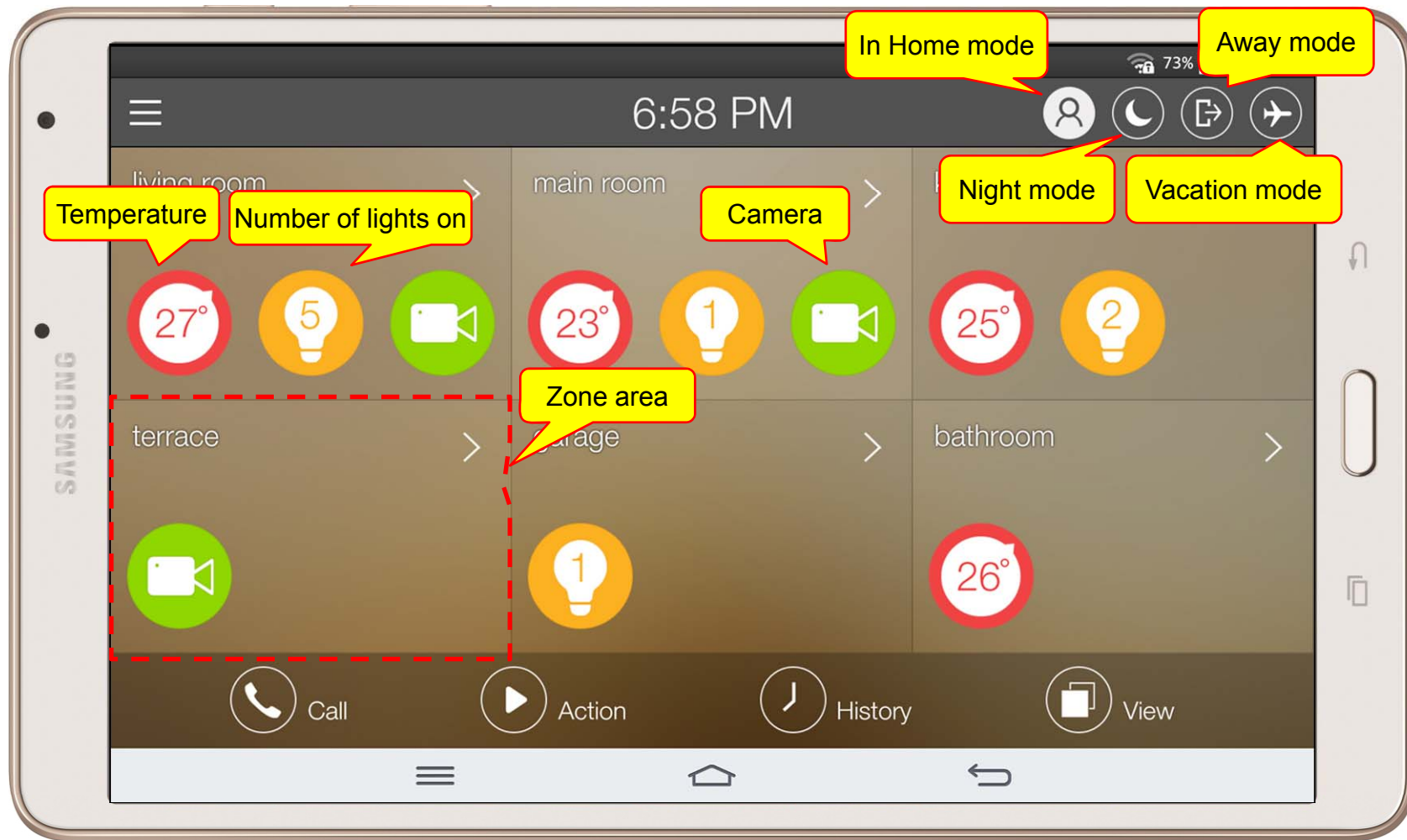

Main View (Cont.)



Main View (Zone Detail)

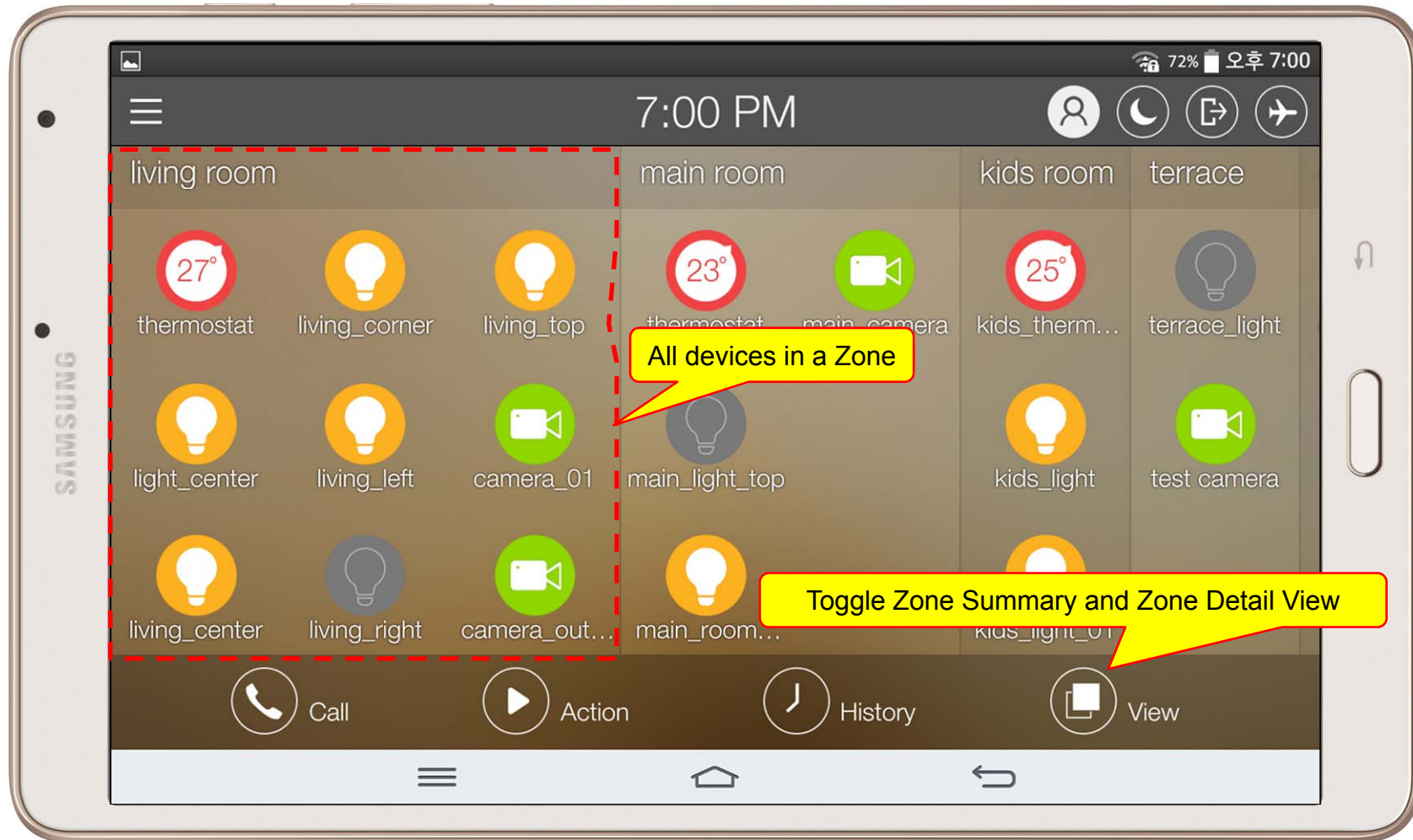

Armed Mode

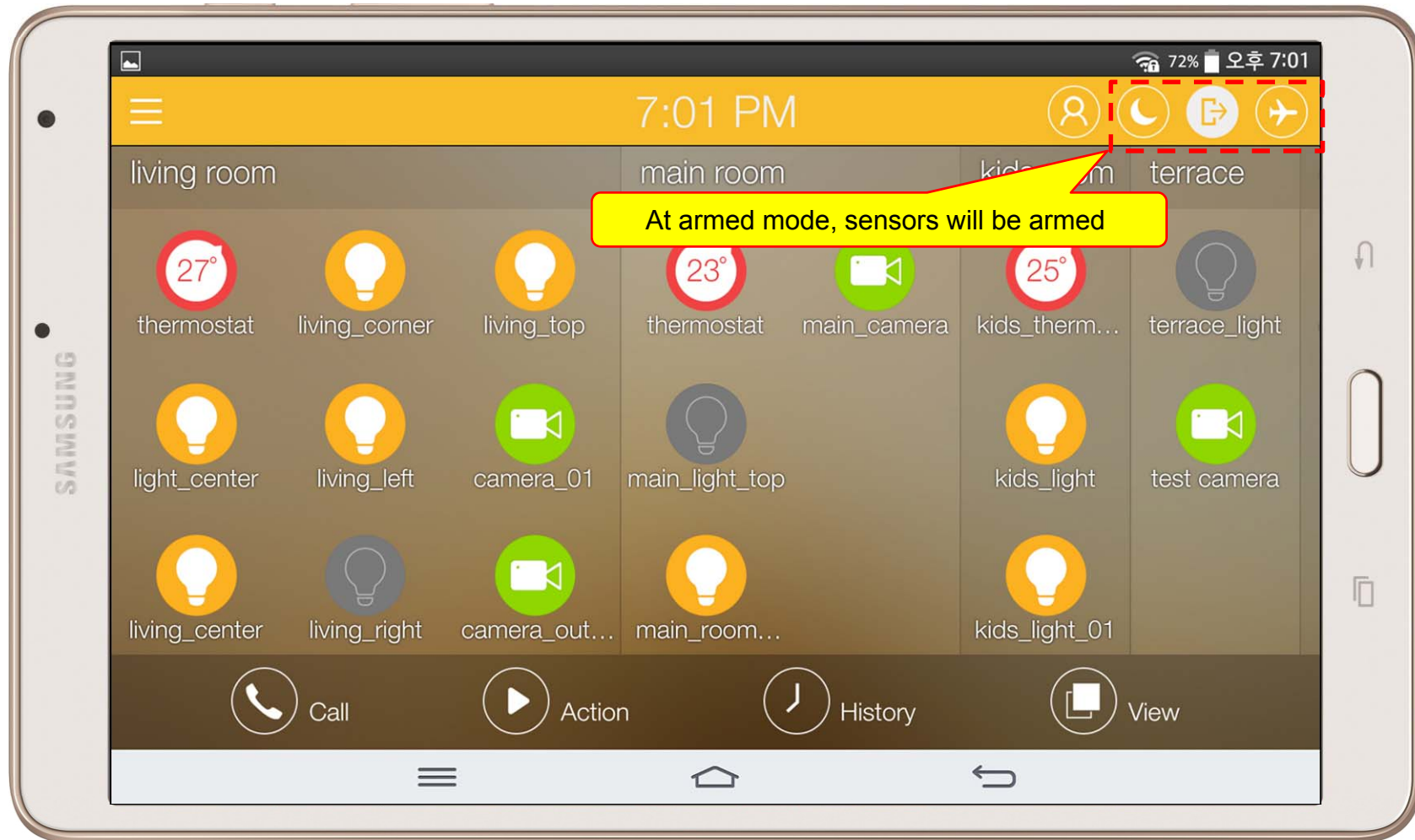

Video Call View

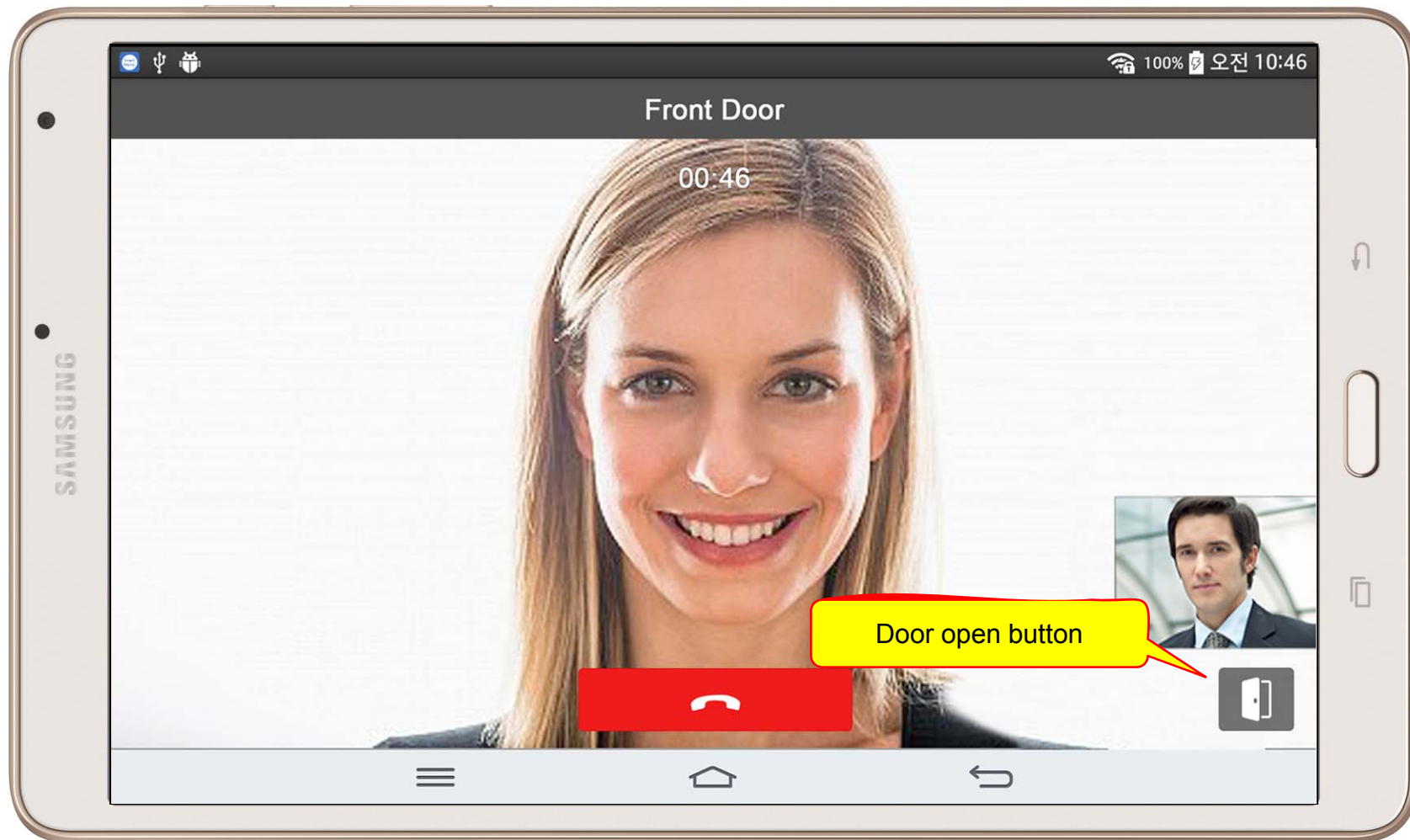



Thank you!

AddPac Technology Co., Ltd.
Sales and Marketing

Phone +82.2.568.3848 (KOREA)

FAX +82.2.568.3847 (KOREA)

E-mail sales@addpac.com