

# AP-VAC300

## IP Video Door Phone

High Performance IP Video Door Phone Solution

### Motion Sensor Interworking Service for Video Door Monitoring



Motion Sensor

# **AddPac**

## AddPac Technology

Sales and Marketing

[www.addpac.com](http://www.addpac.com)

# Contents

- Video Monitoring Service Overview using Motion Sensor
- Smart Video Controller Overview
- Video Monitoring Service Diagram
- Video Monitoring Service Scenario
- Video Monitoring Service RTSP Call Flow
- Smart Video Controller Configuration
  - Configuration
  - Program Setup

# Overview

- Motion Sensor Interworking Service for Video Monitoring Service
- Video Door Phone Side : External Motion Sensor
- PC Side : Smart Video Controller Software and MS-window based Video Decoder Program such as VLC, etc
- RTSP(Real Time Streaming Protocol) Protocol Support
- Multiple Video Decoder & Displayer Controlling
- Application Aware Motion Detection Algorithm

# Smart Video Controller Overview

- Smart Video Controller Features
  - MS Window based Program : XP, Vista, Window7 support
  - Video: MS Window Program, PC based Video Decoder & Displayer
  - RTSP(Real Time Streaming Protocol) Protocol Support
  - Multiple Video Displayer Controlling
  - Video Monitoring Service using external motion sensor
    - I. AP-VAC300 Video Monitoring with VLC Player

# Video Monitoring Service Diagram

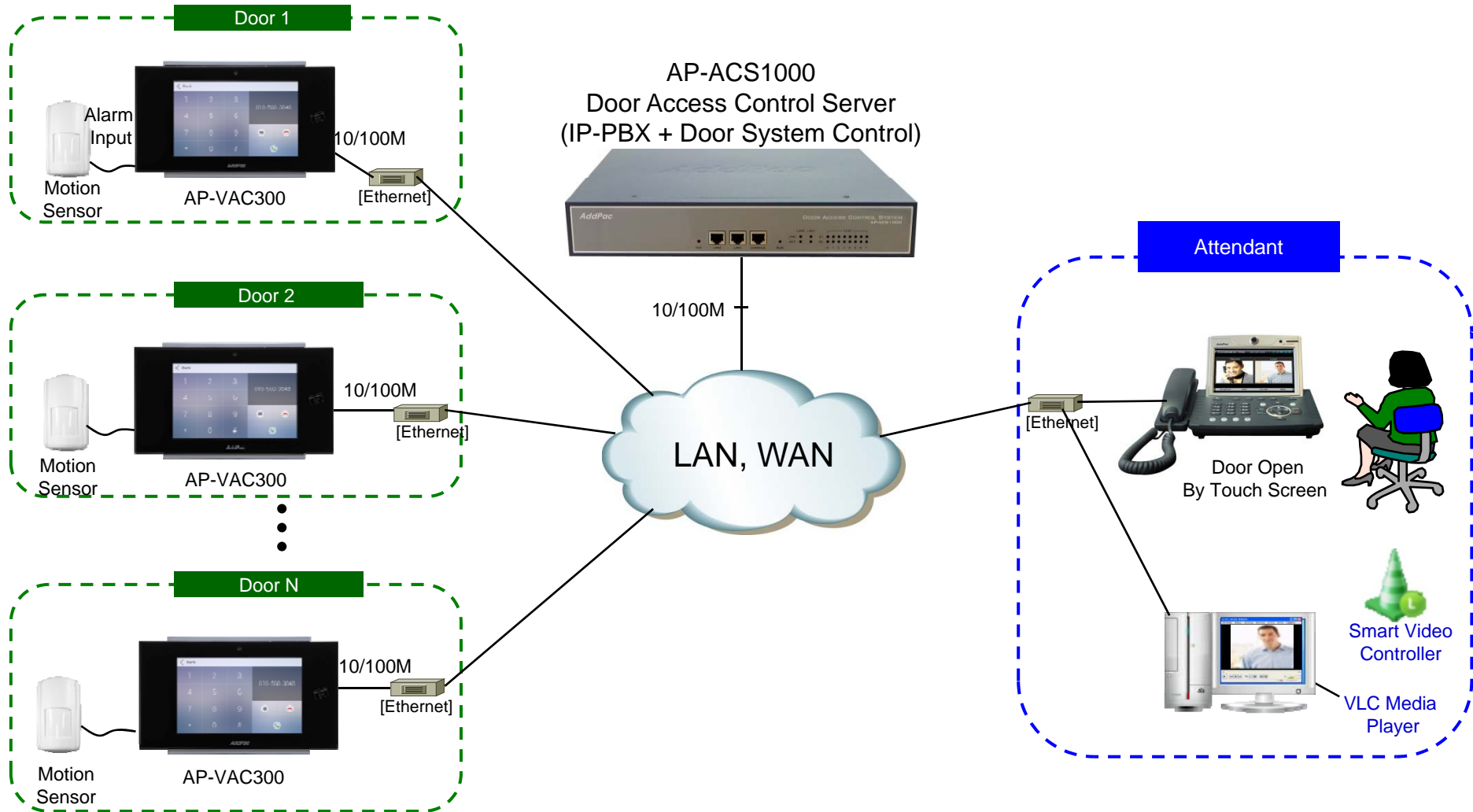

# Video Monitoring Service Scenario

## : AP-VAC50 Video Monitoring with VLC

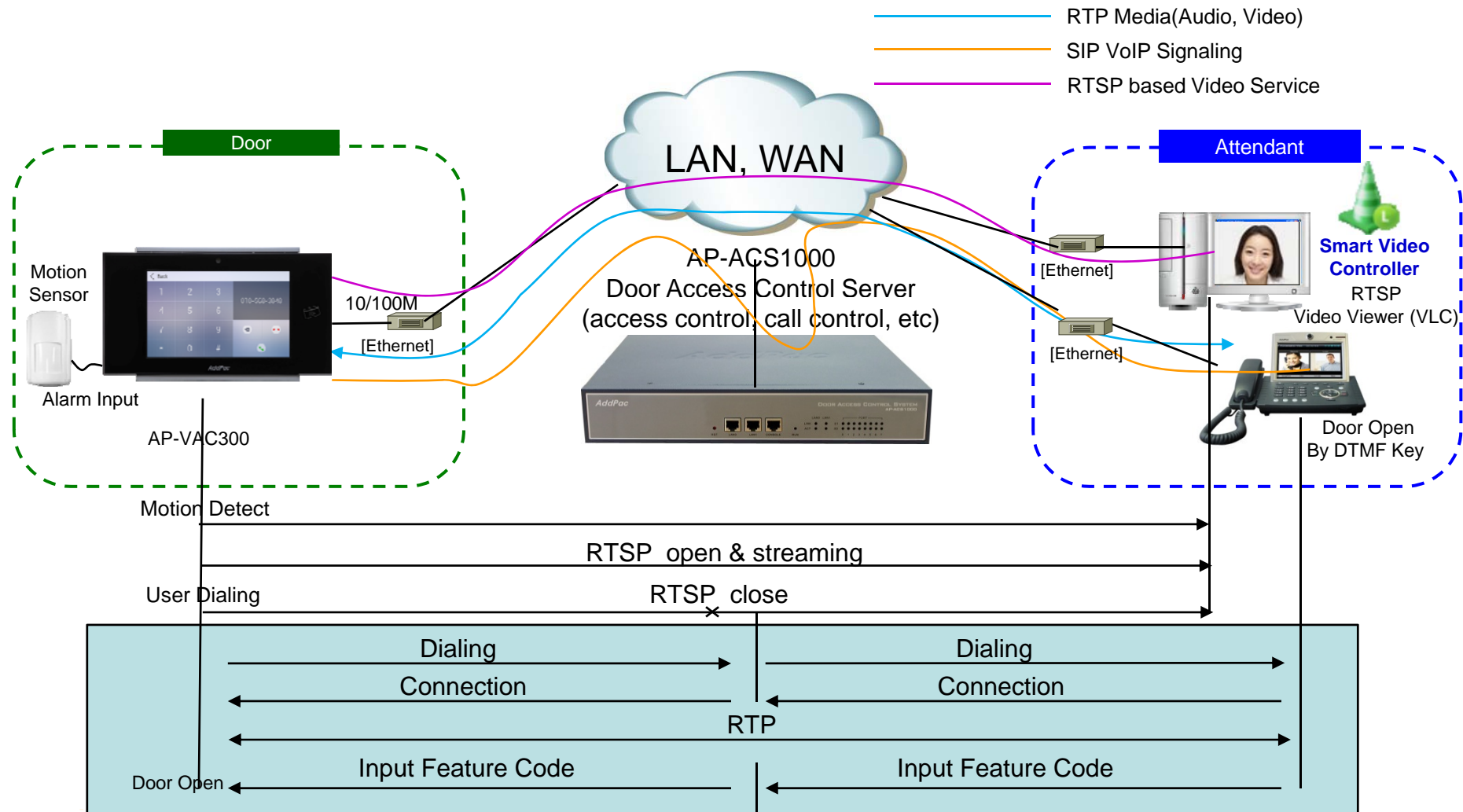

# Video Monitoring Service RTSP Call Flow

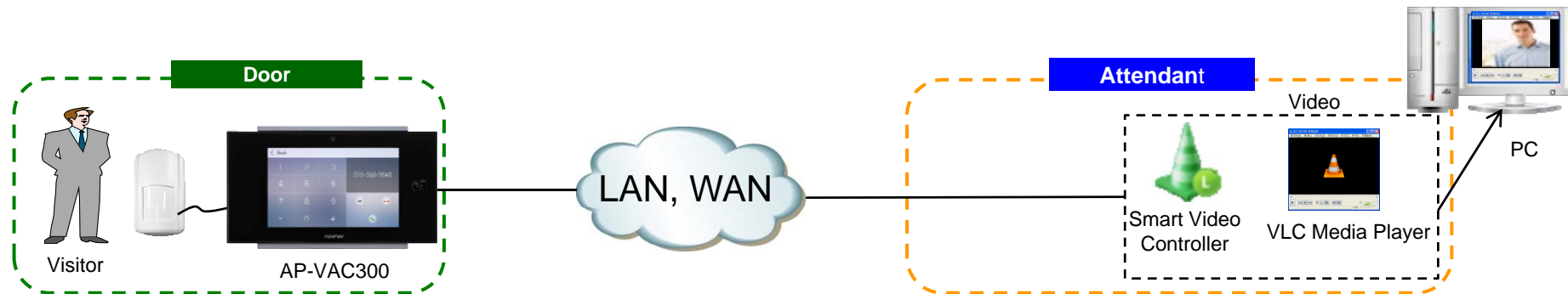

Motion Detect

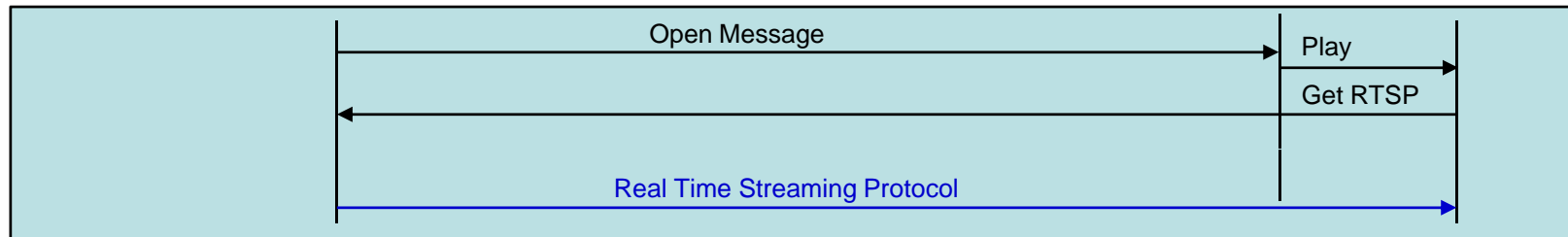

No Motion

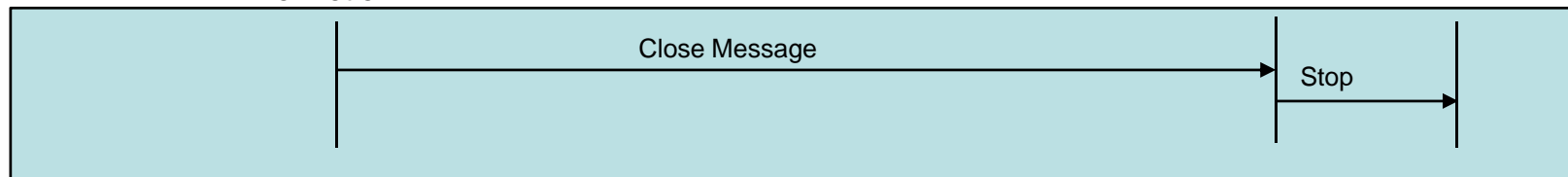

# Smart Video Controller Configuration

No.	Called-Number	IP Address	Port
1	1000	172.17.117.20	19999
2	2000	172.17.117.28	19999
3			
4			
5			
6			
7			
8			
9			
10			
11			

- ① Internal extension (line) number
- ② Personal Computer's IP Address
- ③ Port Number (Default .19999)

[Figure 1]  
AP-VAC50 Smart Web



# Smart Video Controller Configuration (Cont.)

## Smart Video Controller Program Setup

VLC Media Player Program must be pre-installed before Smart Video Controller program setup procedure.

(VLC Player is MS window software that support RTSP based Video Decoder & Display service

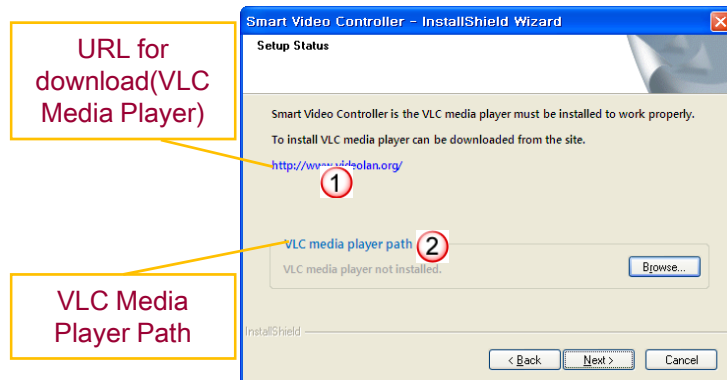

[Figure 1]  
VLC Media Player Install Shield

- ① VLC Program Download URL Address
- ② VLC Program Execution File Path

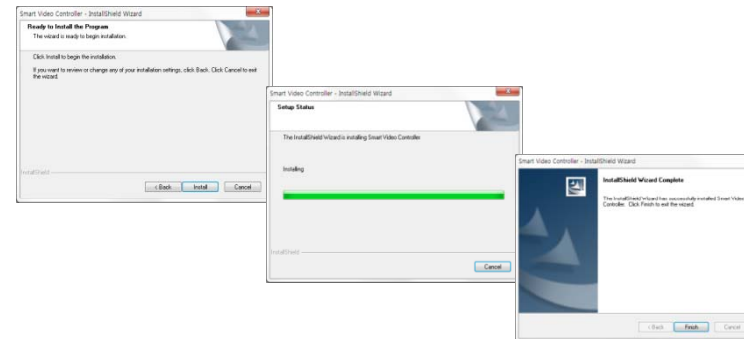

[Figure 2]  
Smart Video Controller Install Progress

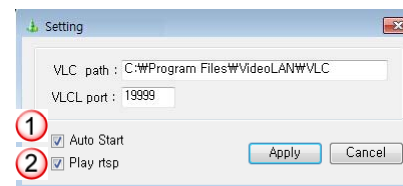

[Figure 3]  
Smart Video Controller Setting

- ① Program Auto Start at PC booting time
- ② Program enable/disable



# Thank you!

**AddPac Technology Co., Ltd.**  
Sales and Marketing

Phone +82.2.568.3848 (KOREA)

FAX +82.2.568.3847 (KOREA)

E-mail [sales@addpac.com](mailto:sales@addpac.com)