

Door Access Control System Solution

Door Access Control System Solution

- AP-ACS10000 Door Access Control System
- AP-ACS1000 Door Access Control System
- AP-ACS500 Door Access Control System

Learn More >

The image displays a collection of hardware and software components for a door access control system. On the left, there is a black server tower. In the center, two computer monitors are shown; the left one displays a software interface with several icons, and the right one shows a detailed report with a bar chart. To the right of the monitors are a keyboard and a mouse. Further right, there is a black server rack, a black server tower, and two black door access control units. One unit is a smaller, vertical device with a keypad and a small screen, while the other is a larger, more complex unit with a larger screen and a keypad.

AddPac

AddPac Technology

Sales and Marketing

www.addpac.com

Contents

- IP Door Access Control Service Diagram
- IP Video Door Phone Solution
- IP Door Access Control Systems
 - AP-ACS10000 Large Scale System (IP-PBX Separated)
 - AP-ACS1000 (IP-PBX Built-in)
 - AP-ACS500 (IP-PBX Built-in)
- DACS System Message Flow (Examples)
- DACM (Door Access Control Manager)
- TAAM (Time and Attendance Manager)
- Open API for Third Party Controller



Large Scale IP Video Door Phone Service Network Diagram

(Separated Door Access Control and SIP Call Control)

IP-PBX Environment

AP-ACS10000 DACS (Door Access Control System)

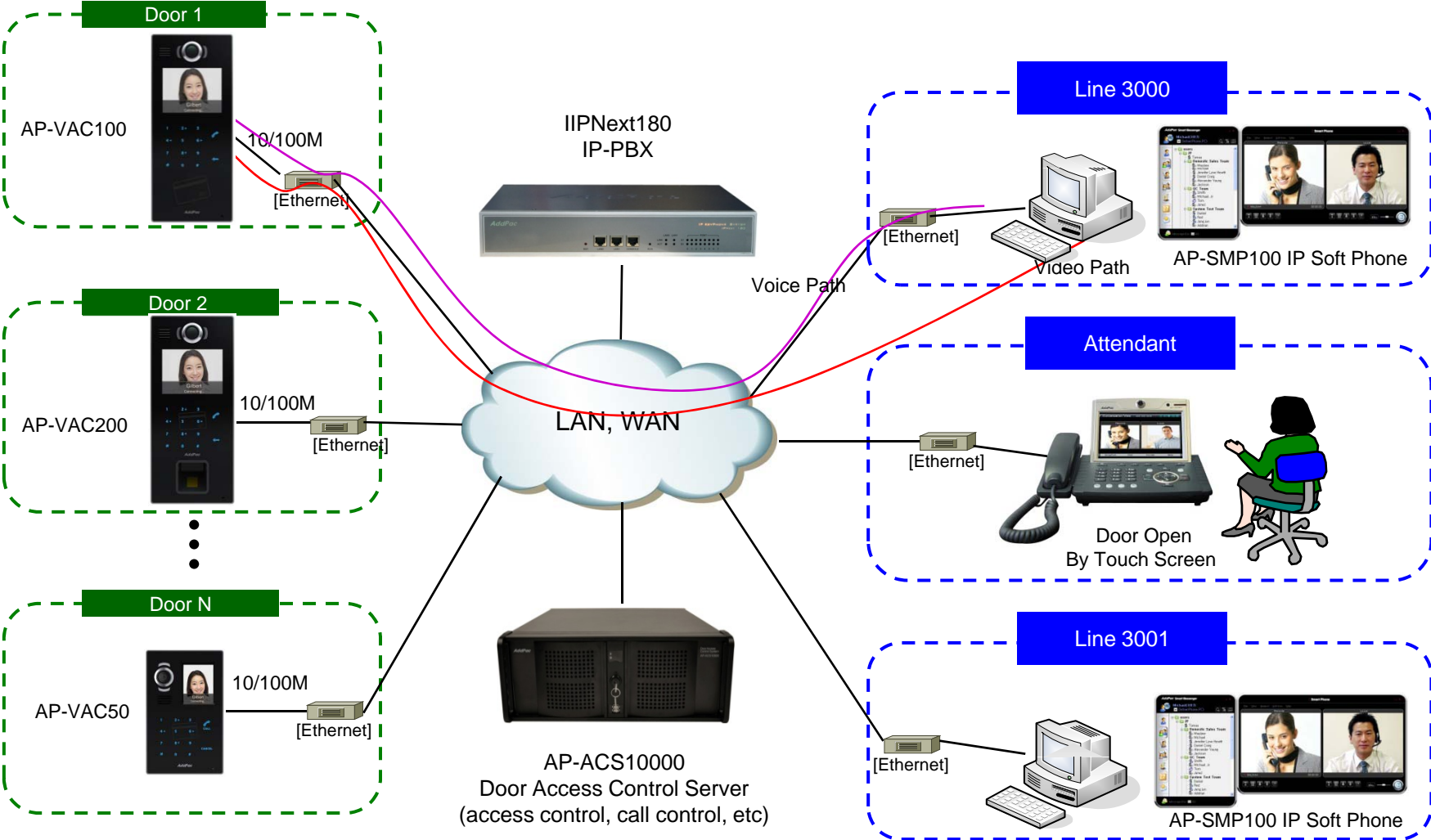

System Redundancy for Fault Tolerant Service

AP-ACS10000 DACS (Door Access Control System)

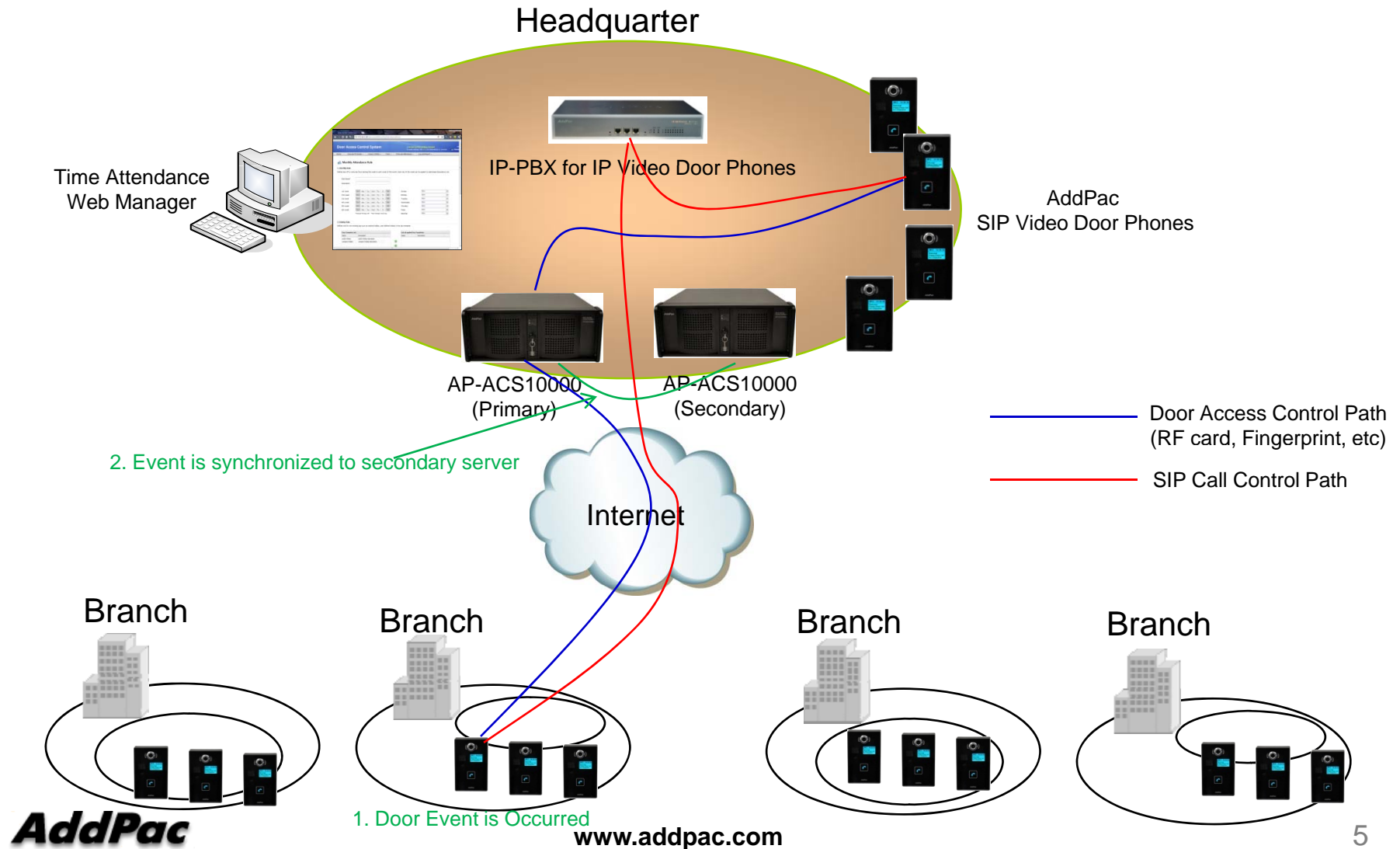



Small & Medium Scale IP Video Door Phone Service Network Diagram

(Integrated Door Access Control and SIP Call Control)

Conventional PBX Environment

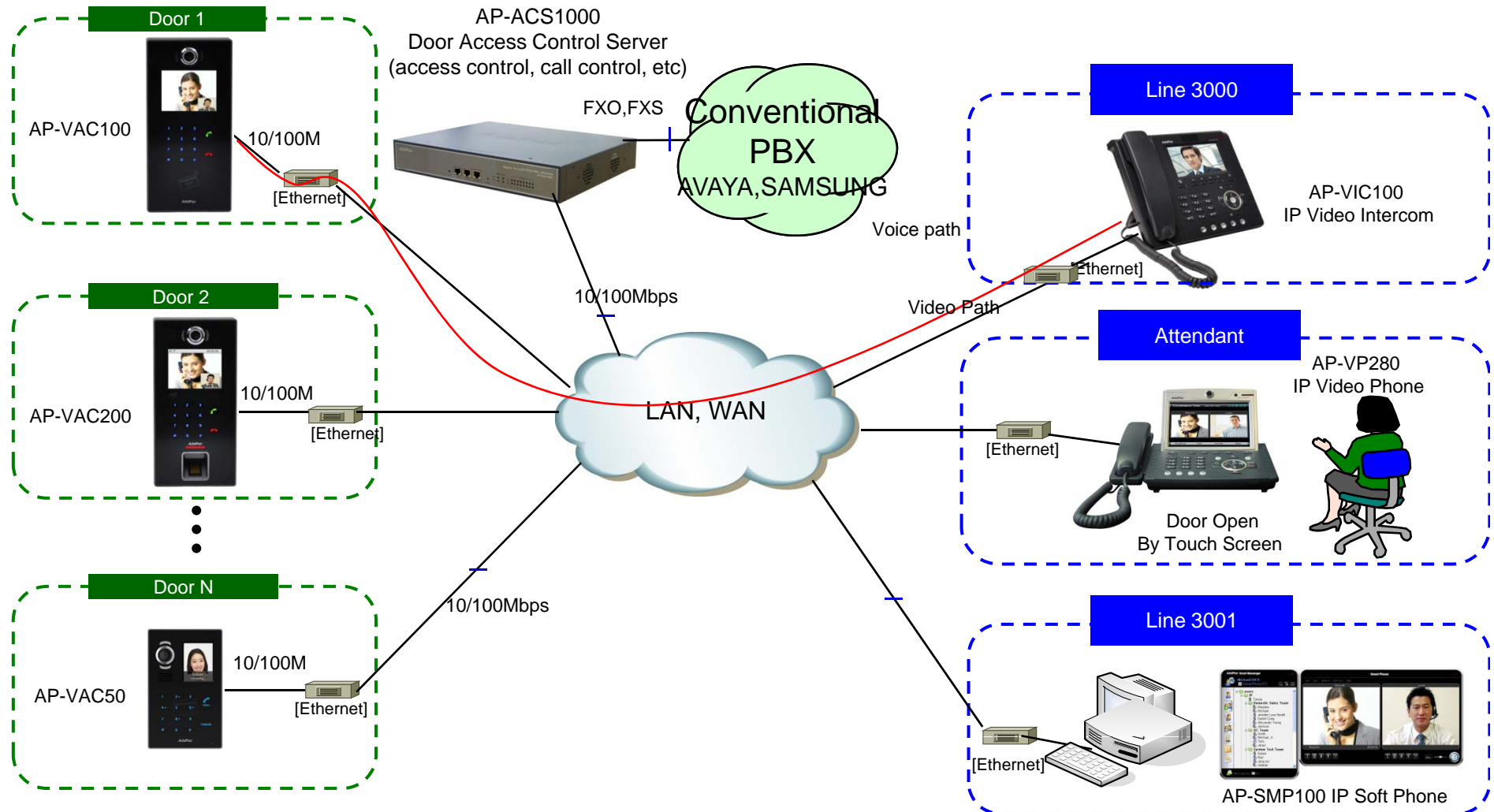

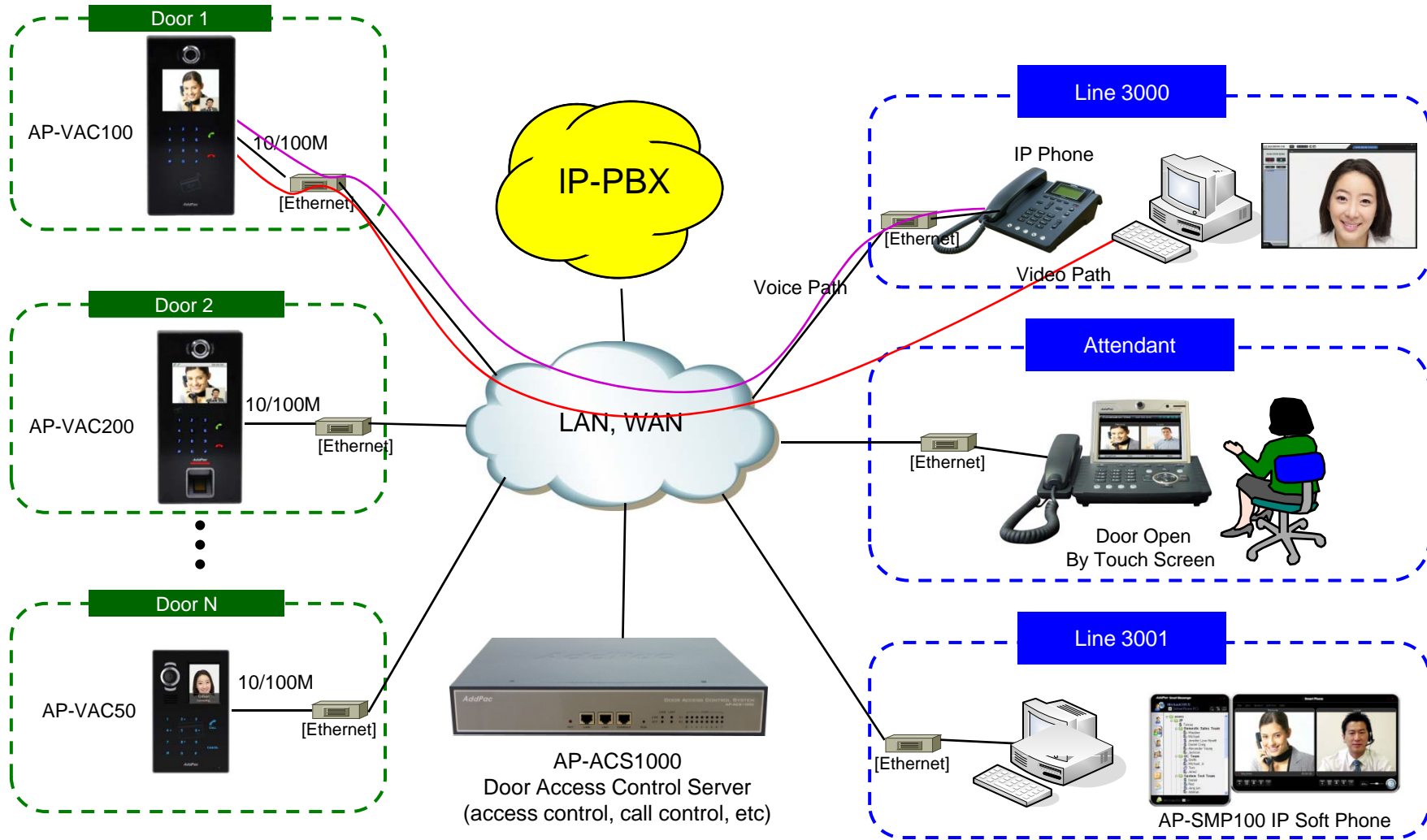

IP-PBX Environment





IP Video Door Phones



IP Video Door Phone Comparison Table

Model	AP-VAC200	AP-VAC100	AP-VAC50	AP-VAC20
Service Features				
Duplex (Voice)	Full Duplex	Full Duplex	Full Duplex	Full Duplex
Key Pad	3x4 Key Support	3x4 Key Support	3x4 Key Support	3x4 Key Support
LCD	3.5 Inch	3.5 Inch	2inch LCD	Graphic LCD
RF Card	Support	Support	Support	Support
Fingerprint	Support	N/A	N/A	N/A
Camera Sensor	SD(VGA)	SD(VGA)	SD(VGA)	SD(VGA)
Video Codec	SD, H.264/MPEG4	SD, H.264/MPEG4	SD, H.264/MPEG4	SD, H.264/MPEG4
Voice Codec	G.711	G.711	G.711	G.711
Signaling	H.323/SIP	H.323/SIP	H.323/SIP	H.323/SIP
MIC & Speaker Phone	Support	Support	Support	Support
LAN Port	1	1	1	1
PoE(Optional)	Support	Support	Support	Support



IP Door Access Control Systems

Door Access Control Server Comparison Table

Model	AP-ACS10000	AP-ACS1000	AP-ACS500
Service Features			
Registration User Number	N/A	100	30
Concurrent Call User Number	N/A	30	15
VoIP Signaling	Internal	N/A	SIP
	External	N/A	H.323/SIP
Powerful IVR, UMS, Media Service, User Presence Service	N/A	Support	Support
RTP Proxy Service (IPv6, Private IP)	N/A	Support	Support
LAN Port	1	2	2
VoIP Module Slots for PSTN	N/A	2 Slots (8 Port Module)	N/A
VoIP Interface	N/A	FXS,FXO,E1/T1	Option
Video Door Phone Control (RF card, etc)	Support	Support	Support
Time & Attendance Management	Support	Support(option)	Support (Option)

Contents

- DACS(Door Access Control Server) Network Diagram
 - IP-PBX Integrated Service Model
 - IP-PBX Separated Service Model
- AP-ACS10000 Overview
- AP-ACS1000 Overview
- AP-ACS500 Overview

Integrated Door Access Control and Call Control

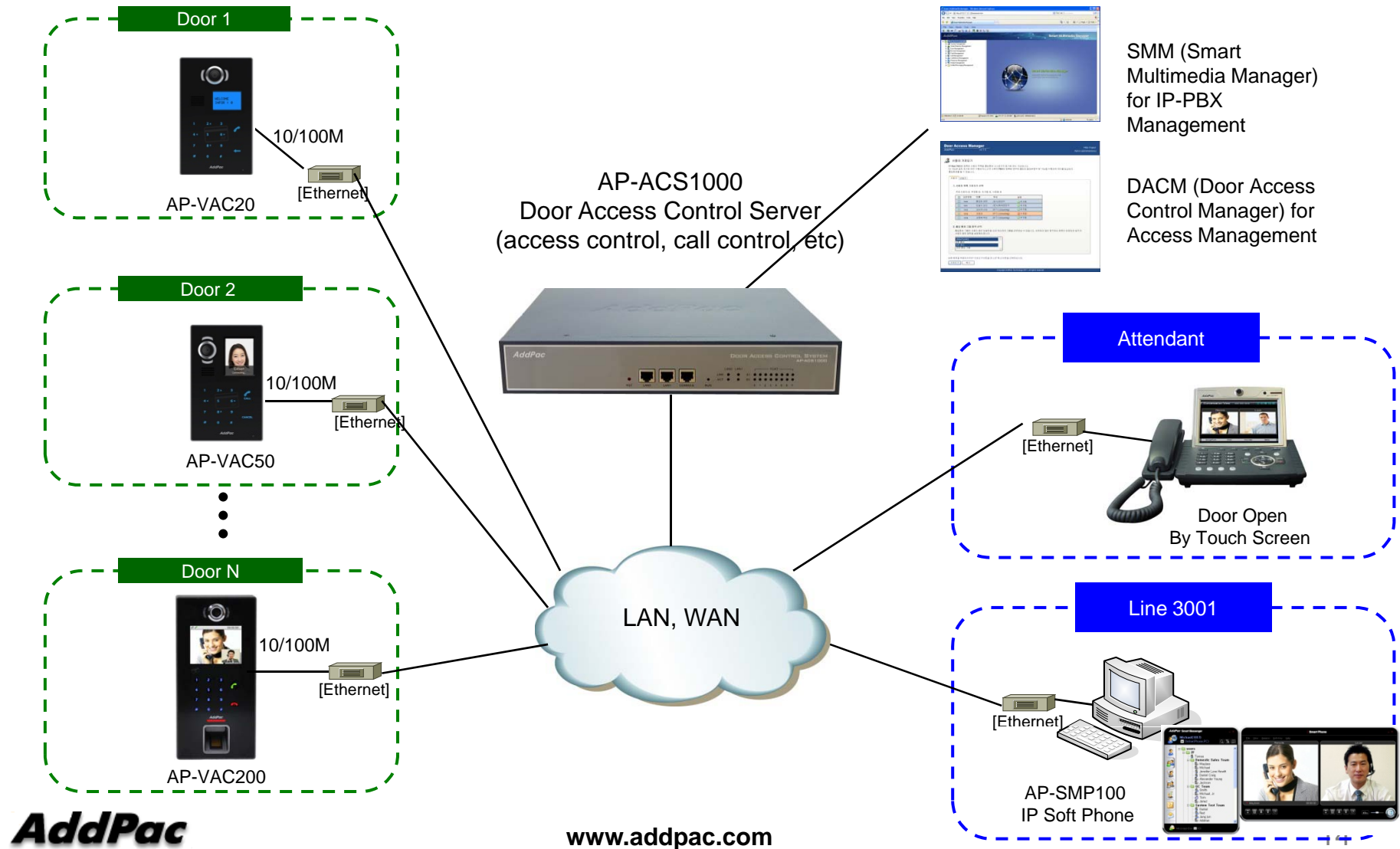

Separated Door Access Control and Call Control

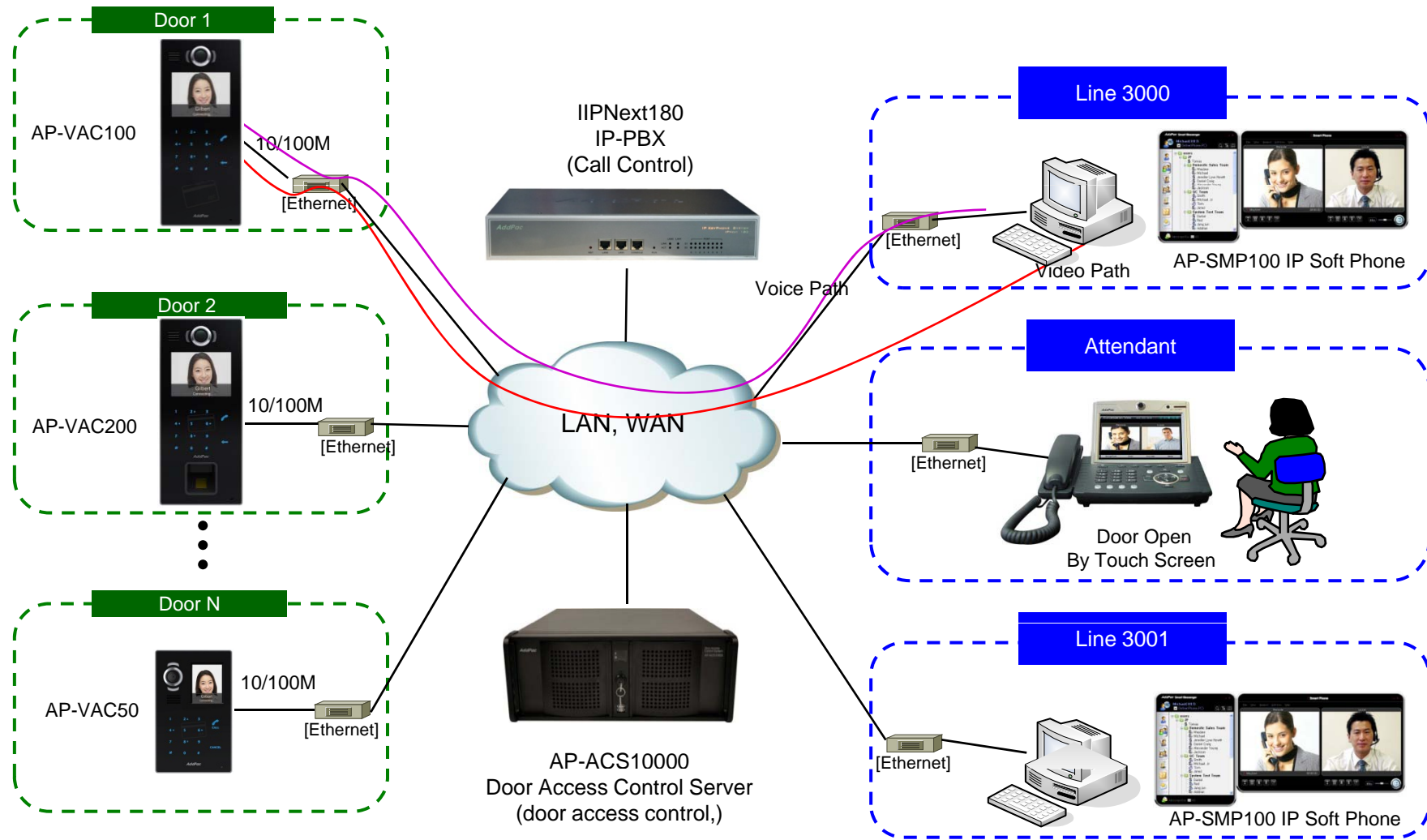



AP-ACS10000 Door Access Control System

Main Features

AP-ACS10000 DACS (Door Access Control System)

- Large Scale Door Access Control Service Features
- Linux Operating System
- Time & Attendance Control System
- Server & Client Architecture
- System Duplication Support for Fault Tolerant Service
- RF Card, Fingerprint Video Door Phone Interworking Service
- Smart Time & Attendance Manager Support (Web based)
- Excel File Import Function for Large User Registration
- Powerful Management and User Friendly Features
- Open API Support for Third Party
- Firmware Upgradeable Architecture
- Up to 4 x 3.5Inch Hard Disk (SATA Type, 2Tera Byte Support)
- One(1) 10/100/1000Mbps Gigabit Ethernet Interface
- USB Interface Support (Front Side, Back Side)

Hardware Specification

AP-ACS10000 DACS (Door Access Control System)



- High Performance Computing Power
- Main Chassis
 - Network Interface
 - One(1) 10/100/1000Mbps Fast Ethernet
 - Video Output Interface
 - HDMI, DVI, RGB Video Output
 - USB 2.0 Interfaces for Mouse, Keyboard, etc
 - One(1) DVD Writer for Video File Backup
 - Up to Four(4) Hard Disk

Hardware Specification

AP-ACS10000 DACS (Door Access Control System)

High End Processor

Front Side

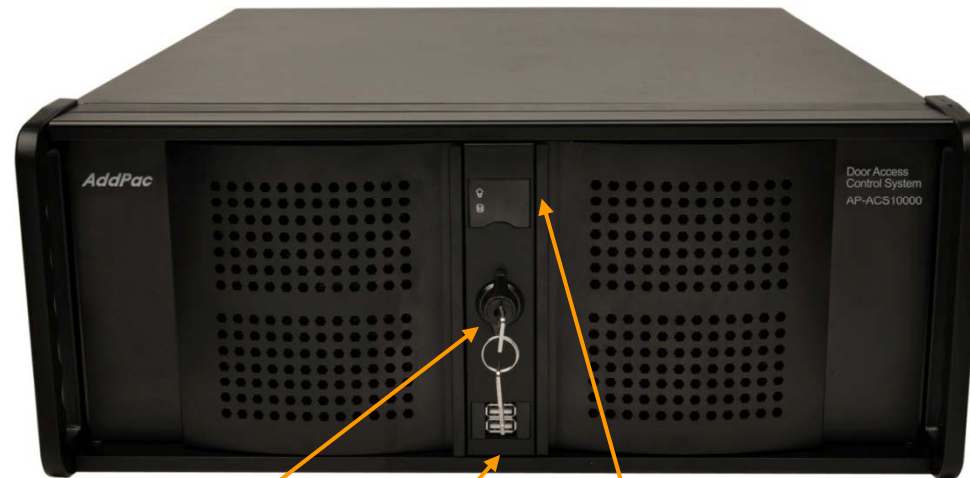

Cabinet Open Key

USB Interface

Power & HDD Access Indication LAMP

Hardware Specification

AP-ACS10000 DACS (Door Access Control System)

High End
Processor

Front Side

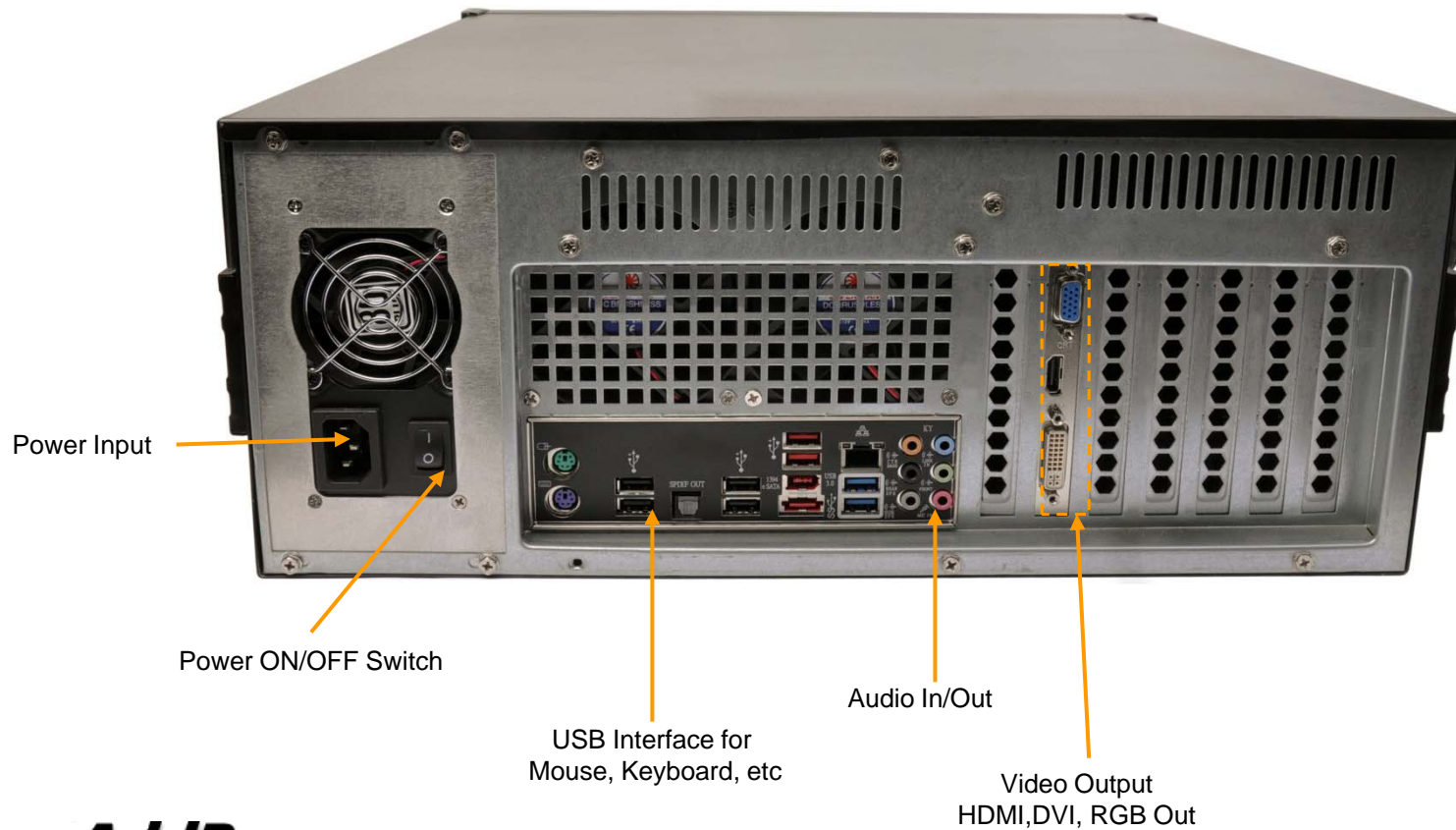



AP-ACS1000 Door Access Control System

Main Features

AP-ACS1000 DACS (Door Access Control System)

- Door Access Control Application System
- SIP Application Server, Proxy, Registrar and Location Server
- Multiple ITSP Trunk with SIP & H.323 Accounts Support
- Legacy PBX Interworking Service
- High Performance RISC & Programmable DSP Architecture
- Two(2) 10/100Mbps Fast Ethernet (IP Share ,etc)
- High Performance LAN-to-LAN Routing Capability
- Powerful Network Protocols (PPPoE, DHCP, Static Routing, etc)
- IPv4/IPv6 Dual Stack
- Firmware Upgradeable Architecture
- Smart Multimedia Manager for IP-PBX Management
- DACM(Door Access Control Manager)
- Advanced Voice QoS Mechanism
- Small, Light and Compact Design
- Two(2) VoIP Module Slots for Analog, Digital Interface

Main Features

AP-ACS1000 DACS (Door Access Control System)

- RISC Microprocessor Computing Power
- Main Chassis
 - Network Interface
 - Two(2) 10/100Mbps Fast Ethernet
 - One(1) RS-232C Console (RJ45)
 - Two(2) VoIP Module Slots for FXS, FXO etc



Hardware Specification

AP-ACS1000 DACS (Door Access Control System)

AP-ACS1000 Back Side



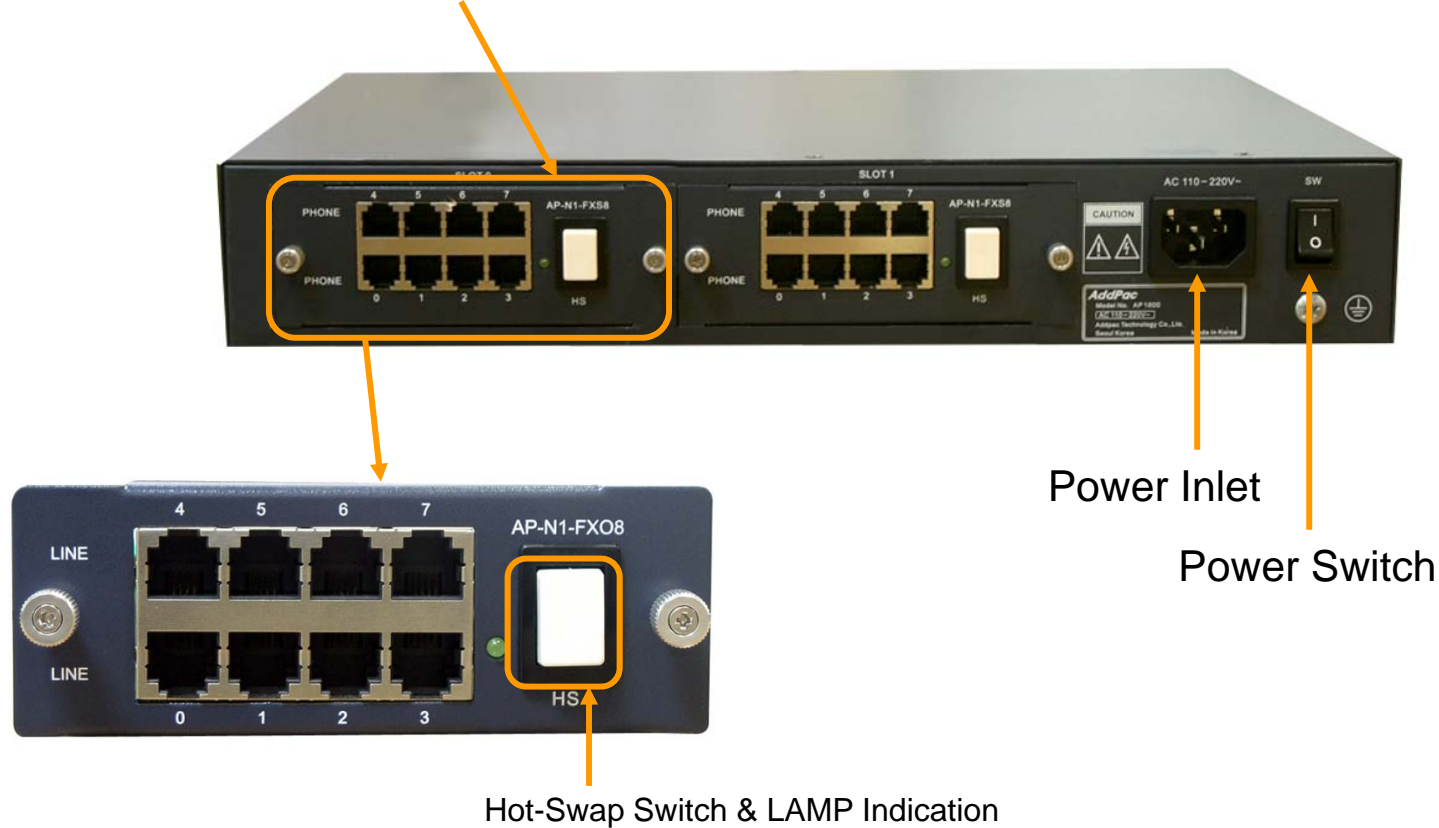

PSTN Interface Module



Hardware Specification

AP-ACS1000 DACS (Door Access Control System)

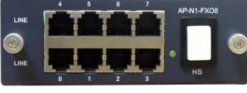
PSTN Interface Module

AP-N1-FXS8	 A black 8-port FXS voice processing module with RJ11 ports numbered 0-7 and a central switch labeled 'HS'.	8-Port FXS Voice Processing Module (8 x RJ11)
AP-N1-FXO8	 A black 8-port FXO voice processing module with RJ11 ports numbered 0-7 and a central switch labeled 'HS'.	8-Port FXO Voice Processing Module (8 x RJ11)
AP-N1-FXO4S4	 A black 8-port voice processing module with 4 FXO and 4 FXS ports, numbered 0-7, and a central switch labeled 'HS'.	4-Port FXO and 4-Port FXS Voice Processing Module (8 x RJ11)
AP-N1-E1T1	 A black 1-port VoIP digital E1/T1 interface module with an RJ45 port and a switch labeled 'HS'.	1-Port VoIP Digital E1/T1 Interface Module(1xRJ45)



AP-ACS500 Door Access Control System

Main Features

AP-ACS500 DACS (Door Access Control System)

- Door Access Control Application System
- SIP Application Server, Proxy, Registrar and Location Server
- Multiple ITSP Trunk with SIP & H.323 Accounts Support
- Legacy PBX Interworking Service
- High Performance RISC & Programmable DSP Architecture
- Two(2) 10/100Mbps Fast Ethernet (IP Share ,etc)
- High Performance LAN-to-LAN Routing Capability
- Powerful Network Protocols (PPPoE, DHCP, Static Routing, etc)
- IPv4/IPv6 Dual Stack
- Firmware Upgradeable Architecture
- Smart Multimedia Manager for IP-PBX Management
- DACM(Door Access Control Manager)
- Advanced Voice QoS Mechanism
- Small, Light and Compact Design
- Power Switch for Stability and Status LEDs



Hardware Specification

AP-ACS500 DACS (Door Access Control System)

- RISC Microprocessor Computing Power + High End Programmable DSP
- VoIP Gateway Interface
 - Model A: Basic Configuration
 - Model B: Two(2) FXO Port
 - Model C: Four(4) FXO Port
 - Model D: Two(2) FXS + Two(2) FXO Port
- Network Interface
 - Two(2) 10/100Mbps Fast Ethernet (RJ45)
- USB Interface
 - One(1) USB Host Mode Interface for USB Memory and Wireless LAN
- Power Supply
 - External Power Adaptor
- Power On/Off Switch
- Power LED, LAN LEDs, FXO Port LEDs





DACS System Message Flow

DACS System Message Flow

Registration and KeepAlive

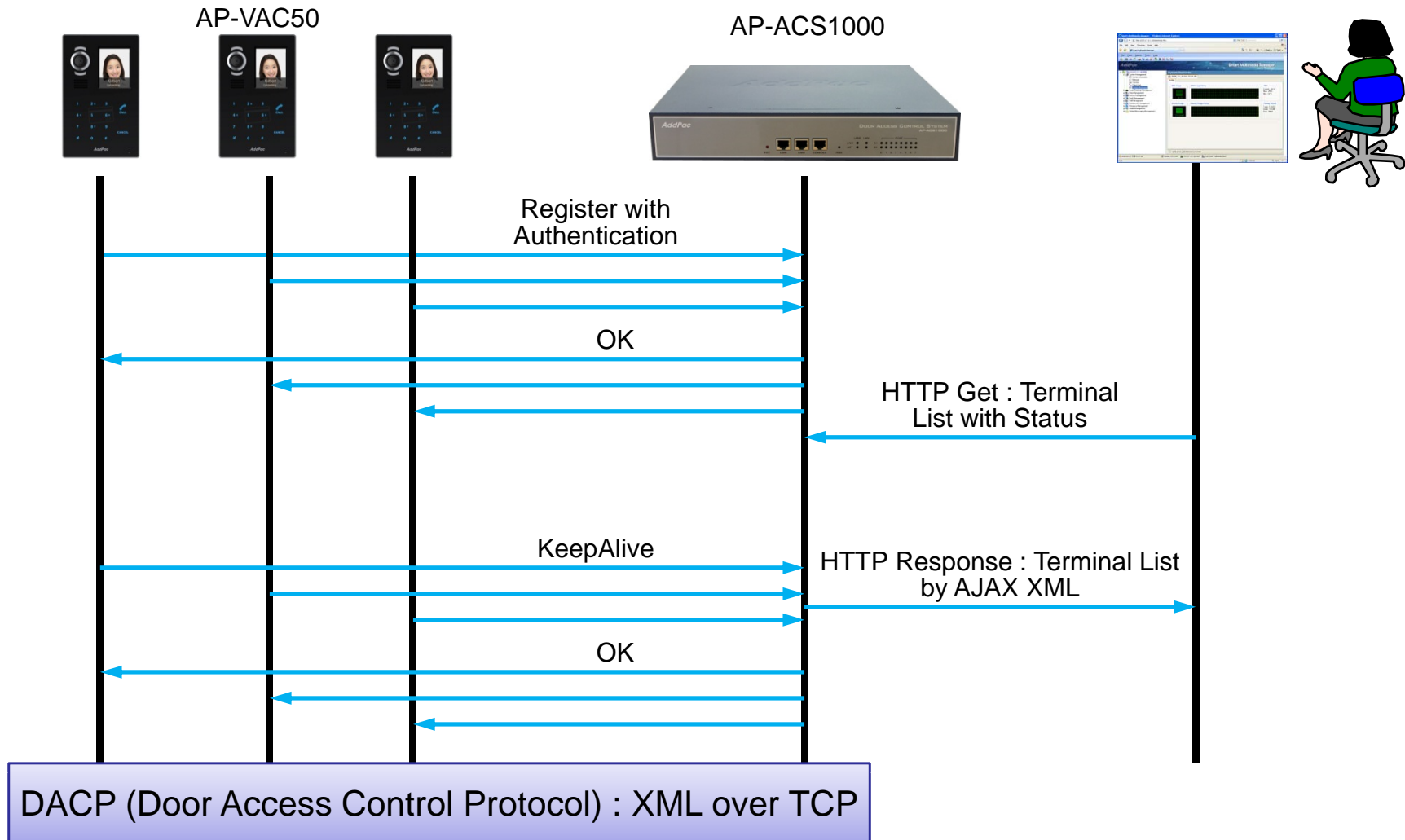

DACS System Message Flow

Access Privilege and Schedule Download

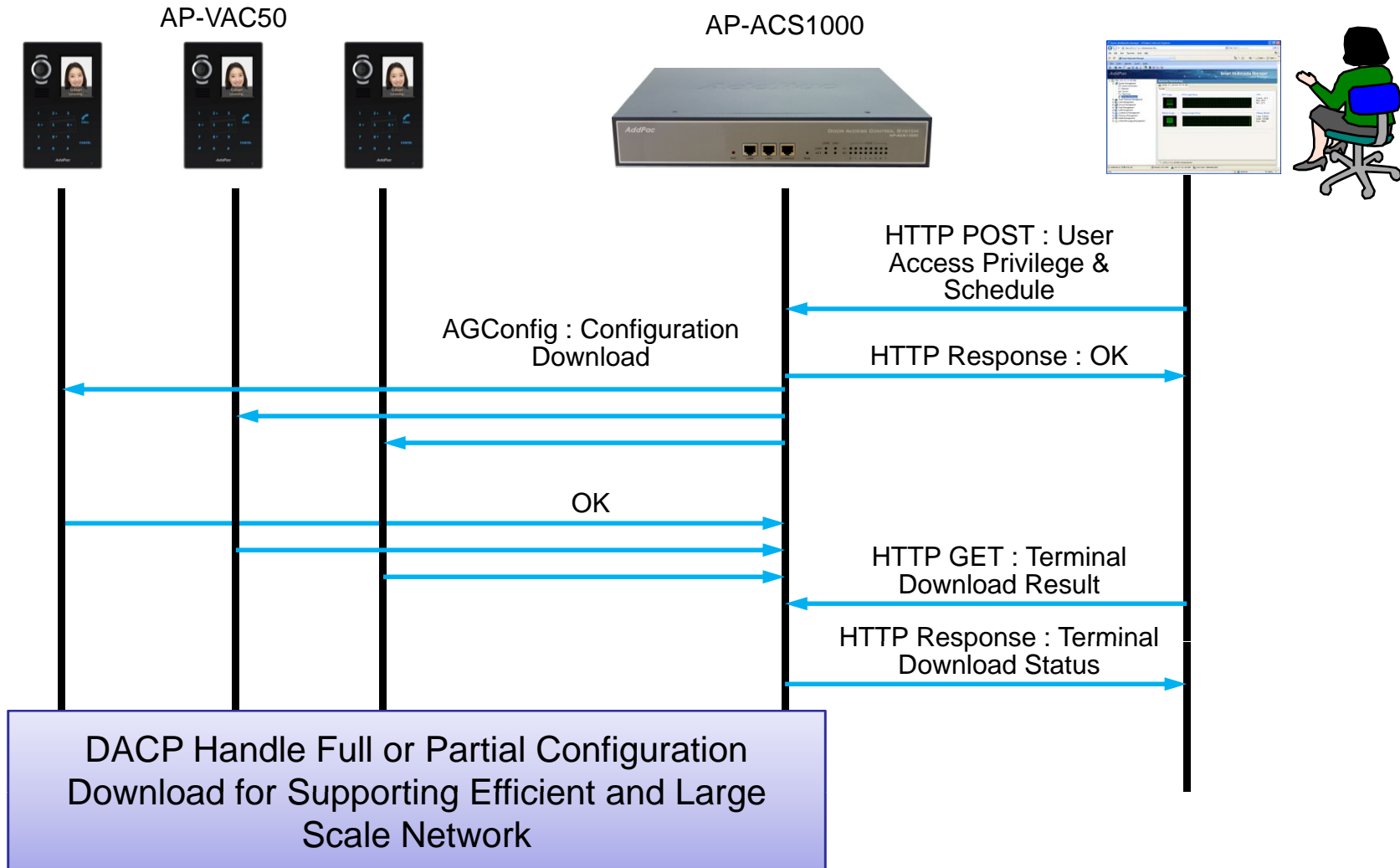

DACS System Message Flow

RF Card Read/Write and Registration

AP-VAC50



AP-ACS1000

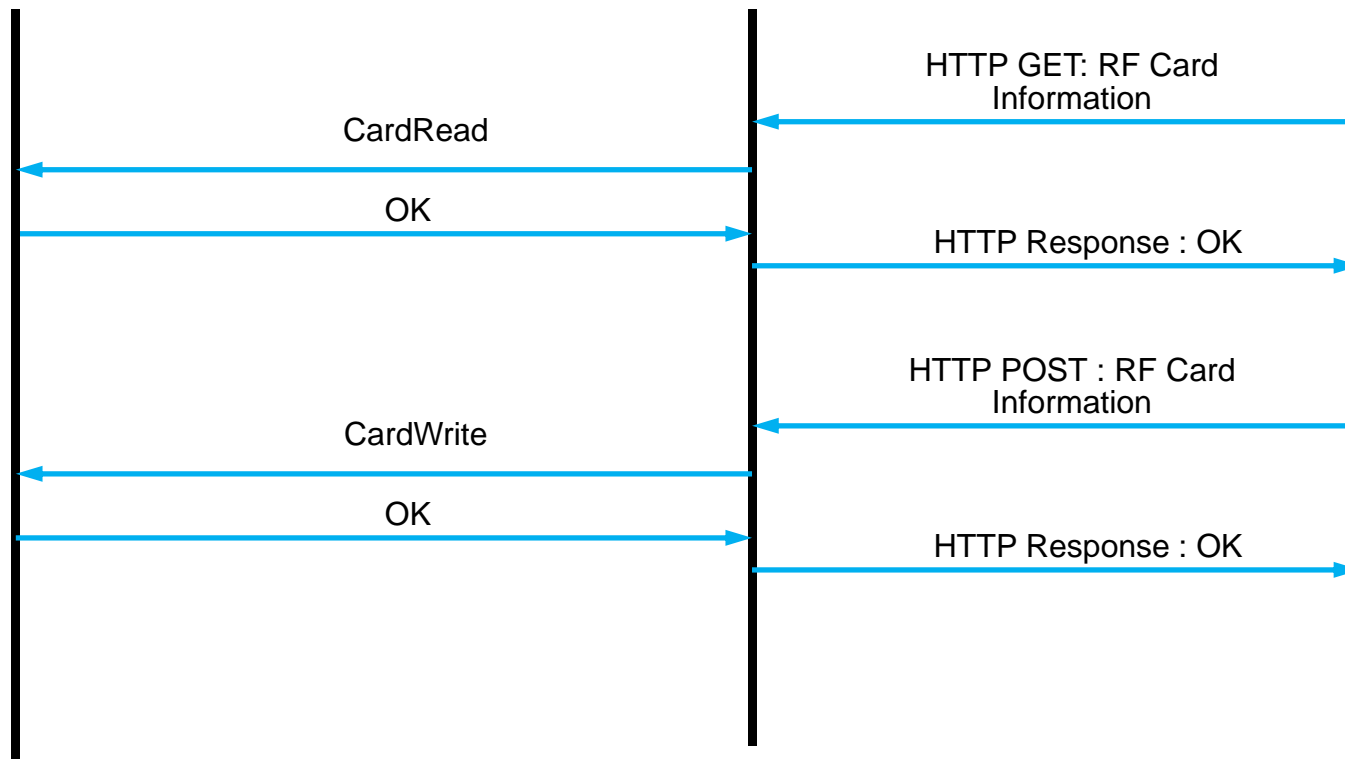
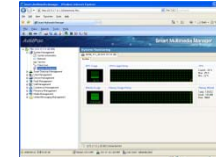

DACS System Message Flow

Door Open by RF Card or Password

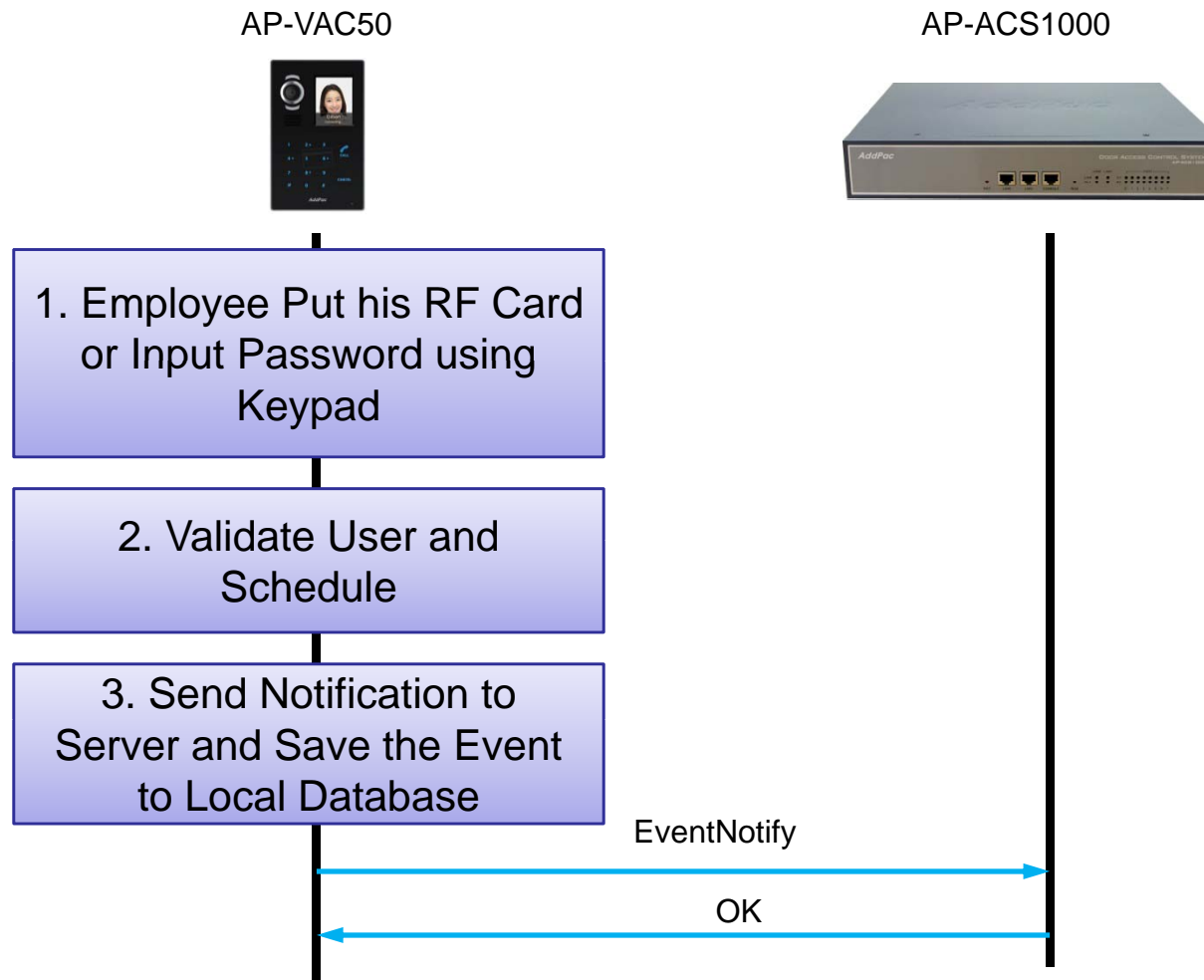

DACS System Message Flow

Door Open by Fingerprint

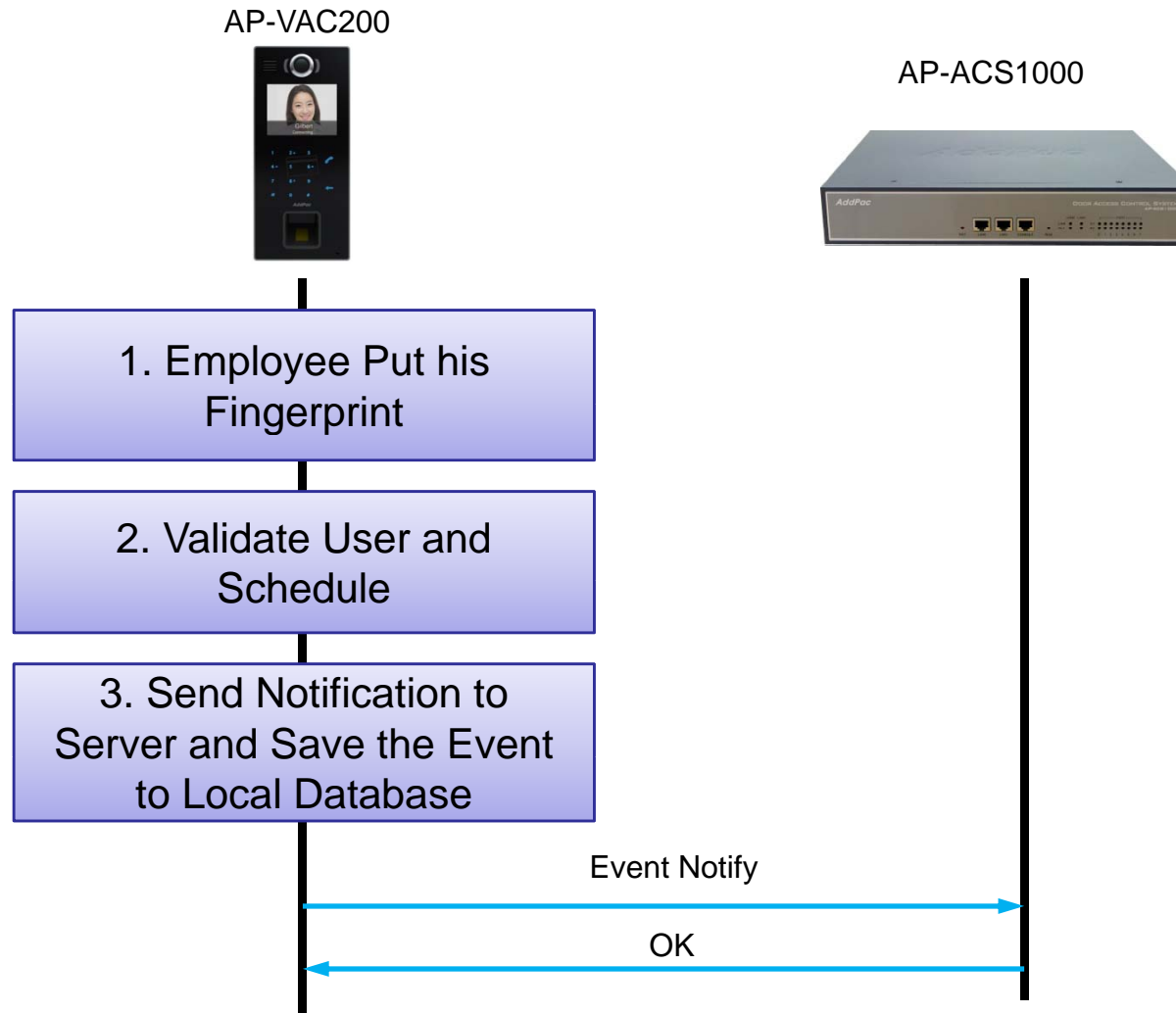

DACS System Message Flow

Door Open by Other Terminal

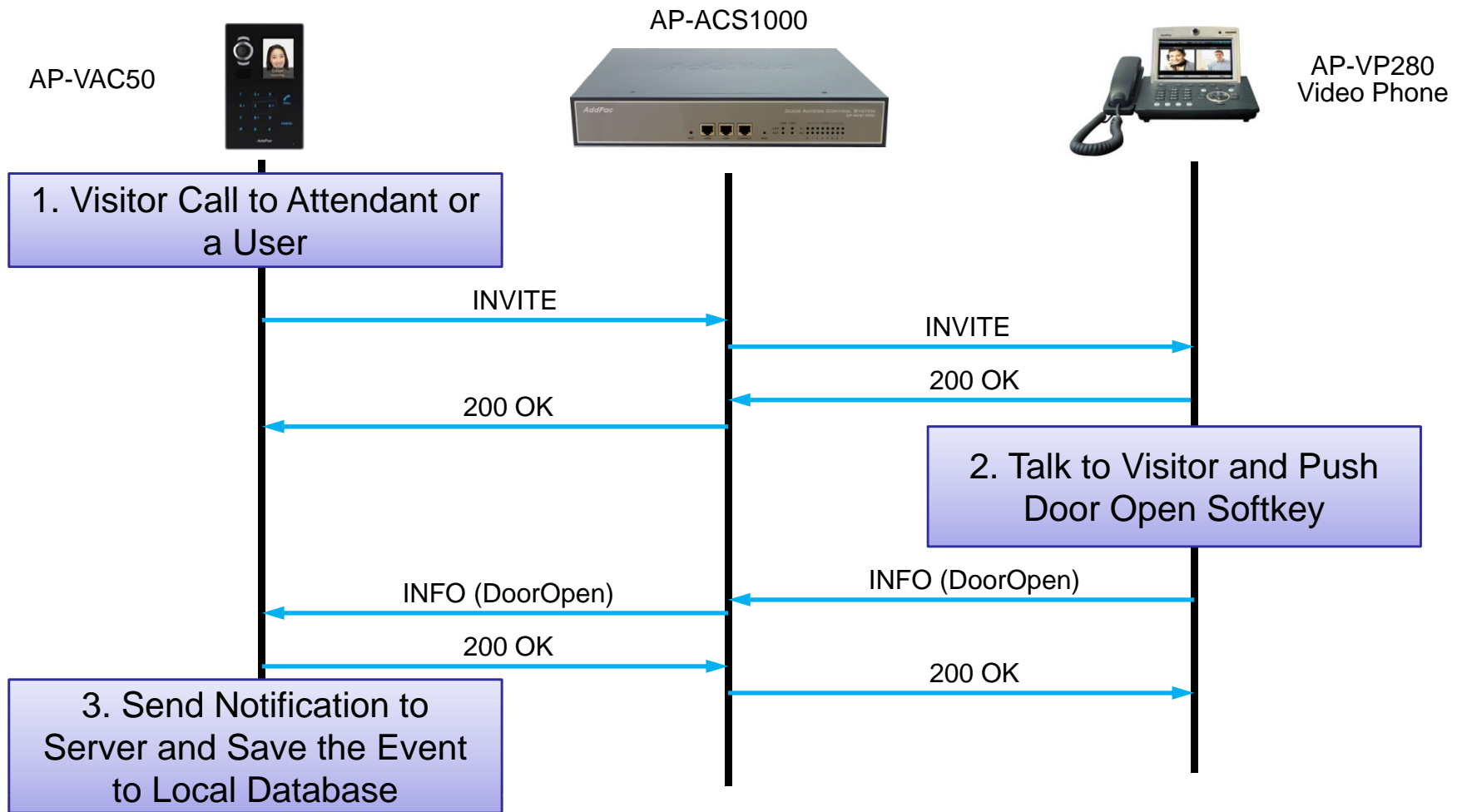

SIP VoIP Message Flow

Door Open by Other Terminal

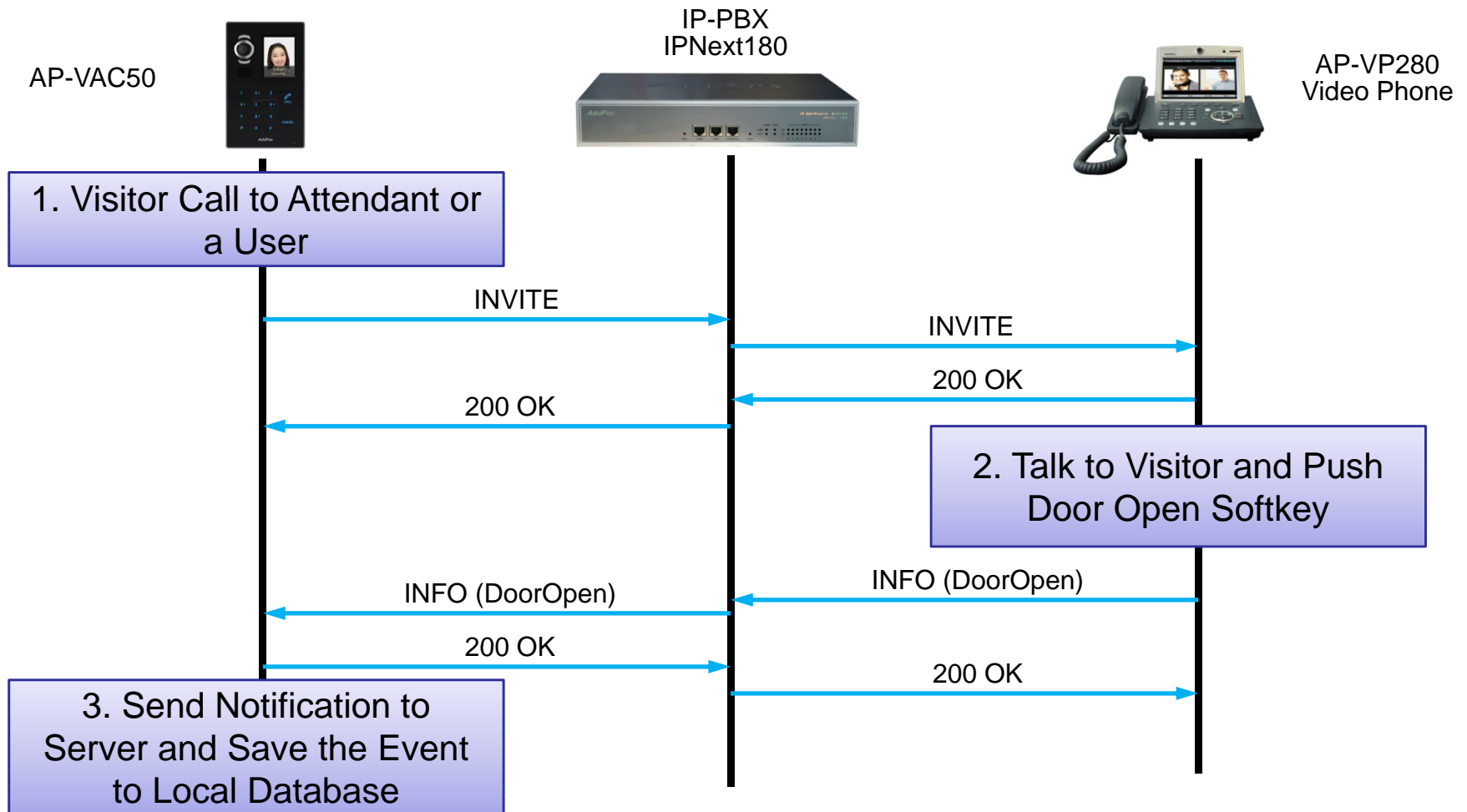



Door Access Control System Web Manager Software (DACM, TAAM)

DACS (Door Access Control System)

Login page

The screenshot shows a web browser window with the URL `172.16.1.19/index.php`. The page title is "Door Access Control System". The main content area features the "AddPac Door Access Control System" logo and a login form with fields for "Administrator ID" (containing "root") and "Password" (masked with dots). Below the form are two buttons: "Door Access Control Manager" and "Time and Attendance Manager".

Annotations on the screenshot include:

- A yellow box at the top center containing the text: "You can log on 'Door Access Control Manager' or 'Time and Attendance Manager' if license is valid and administrator have authentication right". A yellow arrow points from this box to the login form.
- A blue box on the left containing the text: "Log on to Door Access Control Management". A blue arrow points from this box to the "Door Access Control Manager" button.
- A blue box on the right containing the text: "Log on to Time and Attendance Management". A blue arrow points from this box to the "Time and Attendance Manager" button.



Door Access Control Web Manager Software (DACM)

DACM (Door Access Control Manager)

Main Web Page

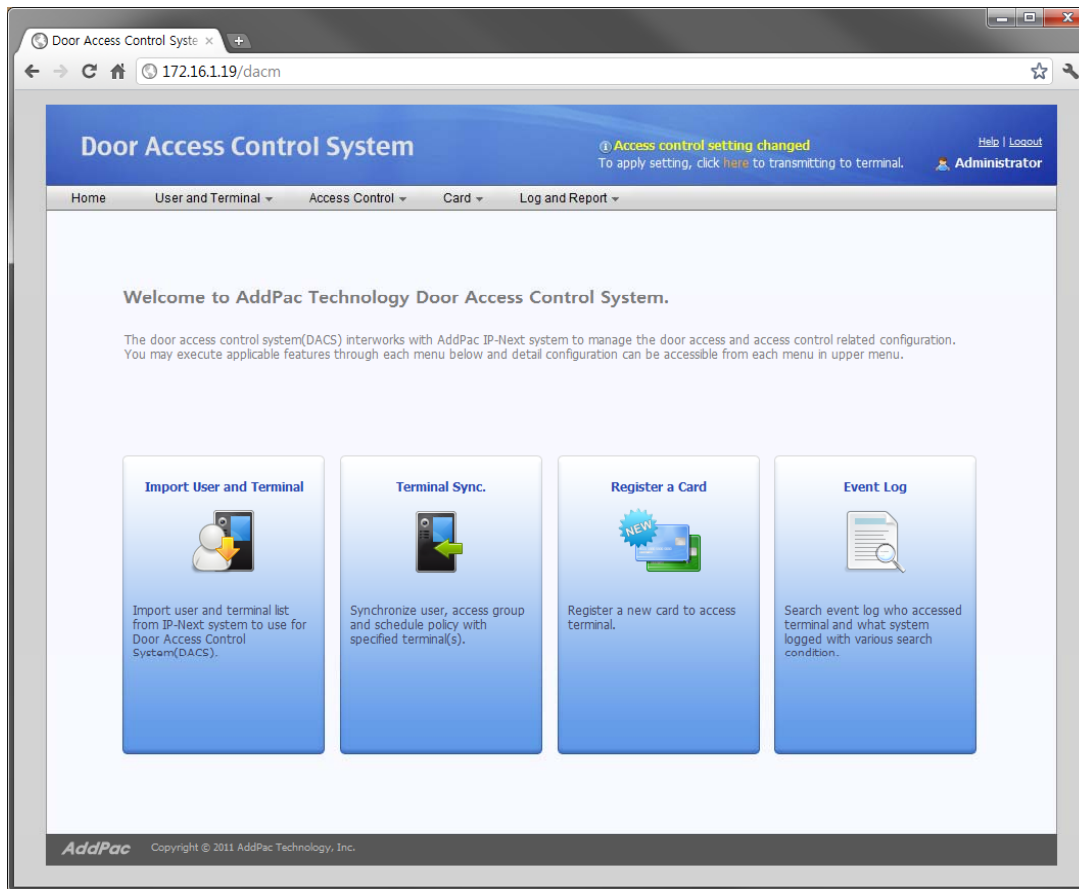

DACM (Door Access Control Manager)

Import User and Terminal

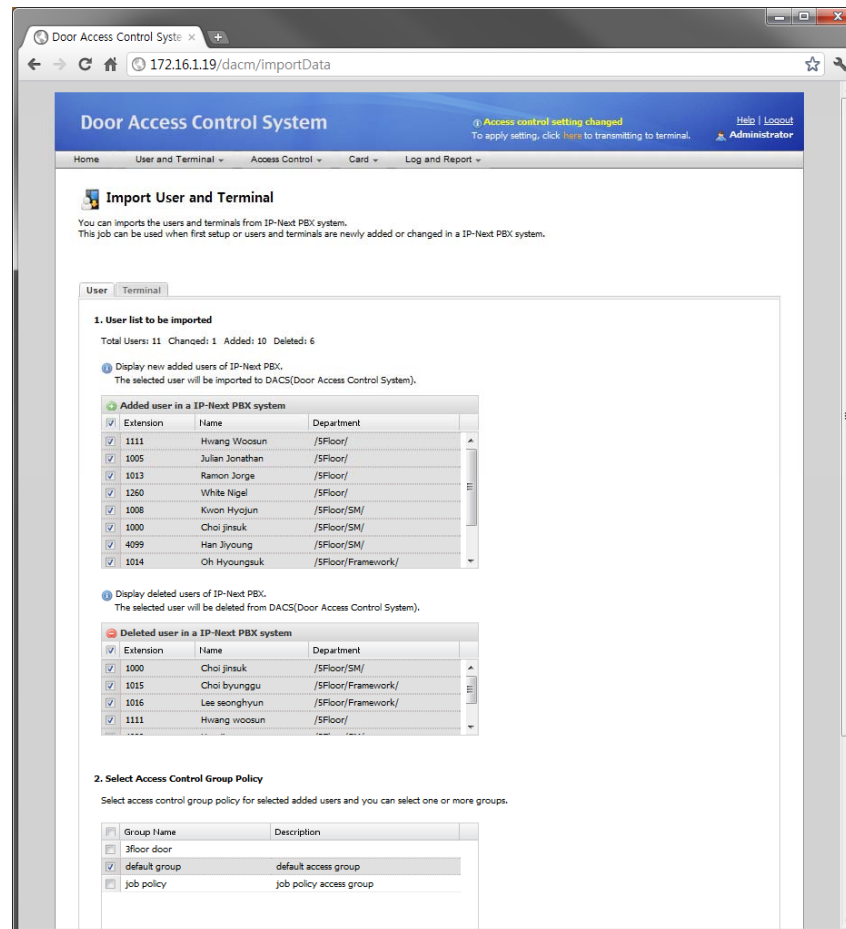

DACM (Door Access Control Manager)

User List

User List

The screenshot shows a web browser window displaying the 'Door Access Control System' user list. The page title is 'Door Access Control System' and the URL is '172.16.1.19/dacm/userList'. A notification at the top right states 'Access control setting changed' with a link to 'here' and a 'Logout' button. The user is logged in as 'Administrator'. The main content area is titled 'User List' and includes a search bar with a dropdown set to 'All Users' and an 'Import User' button. Below the search bar is a table with the following data:

Extension	Name	Department	Access Policy	Date Created	Modify	Delete
1 1000	Choi jinsuk	/SFloor/SM/	Access Allow	2011-07-22 15:50:01		
2 1008	Kwon hyojun	/SFloor/SM/	Access Allow	2011-07-22 15:50:00		
3 1014	Oh hyongsuk	/SFloor/Framework/	Access Allow	2011-07-22 15:50:01		
4 1015	Choi byunggu	/SFloor/Framework/	Access Allow	2011-07-22 15:50:01		
5 1016	Lee seonghyun	/SFloor/Framework/	Access Allow	2011-07-22 15:50:01		

At the bottom of the page, there is a pagination control showing 'Page 1 of 1' and a 'Total: 5' indicator. The footer contains the 'AddPac' logo and 'Copyright © 2011 AddPac Technology, Inc.'.

DACM (Door Access Control Manager)

Access Control Group Management

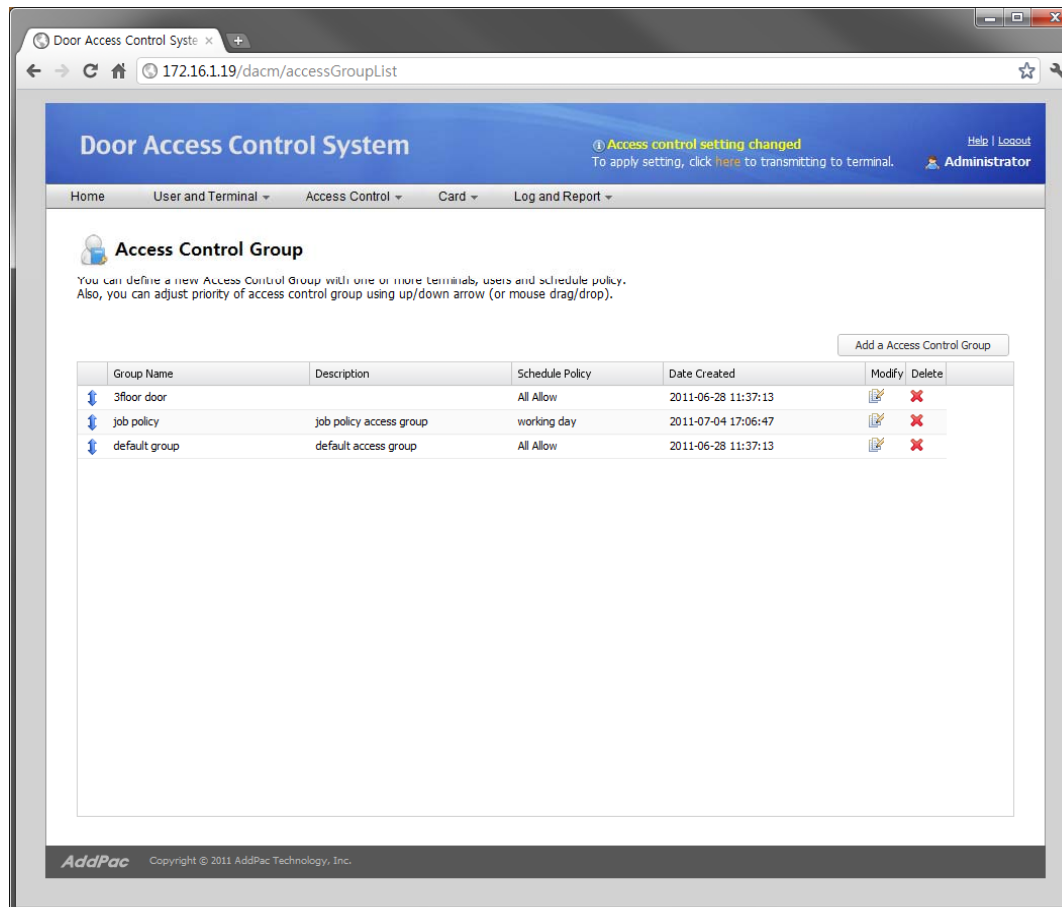

DACM (Door Access Control Manager)

Configuration Download to Terminal

Door Access Control System

Access control setting changed
To apply setting, click [here](#) to transmitting to terminal.

Help | Logout
Administrator

Home User and Terminal Access Control Card Log and Report

Terminal Sync.

Synchronize user, access group and schedule policy with selected terminals.
Default checked terminals have updated configurations need to be synchronized.

<input checked="" type="checkbox"/>	Terminal Name	IP Address	Connection Status	Sync Status
<input checked="" type="checkbox"/>	2floor door terminal	172.16.10.4	Connected	Not yet synchronized
<input checked="" type="checkbox"/>	3floor door terminal	172.16.10.1	Connected	Not yet synchronized
<input checked="" type="checkbox"/>	5floor door terminal	172.16.10.2	Connected	Not yet synchronized
<input checked="" type="checkbox"/>	The main entrance door	172.16.10.3	Connected	Not yet synchronized

To synchronize with selected terminal above, select 'Sync' button below. Select 'Cancel' button to cancel.

AddPac Copyright © 2011 AddPac Technology, Inc.

DACM (Door Access Control Manager)

RF Card Management

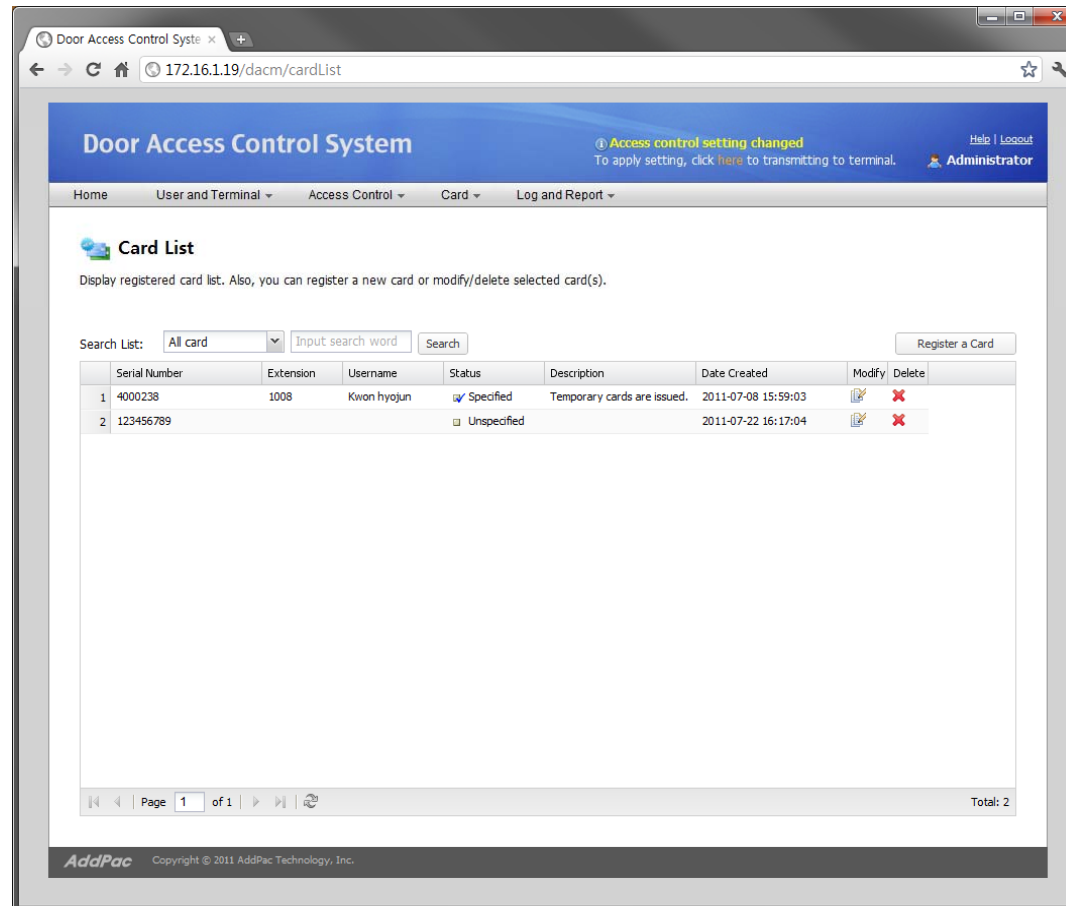

DACM (Door Access Control Manager)

Fingerprint Management

The screenshot shows the 'Door Access Control Manager' web interface. The browser address bar displays '172.17.216.250/webapps/dacm/updateUser/1007'. The page title is 'Door Access Control Manager' and the current user is 'root'. A notification states 'Access control setting changed' with a link to 'here' to transmit settings to the terminal. The navigation menu includes 'Home', 'User and Terminal', 'Access Control', 'Card', and 'Log and Report'. The main content area is titled 'User Information and Policy' and shows the '1. Profile' section. The profile form includes fields for Extension Number (1007), First Name, Last Name (최진석 선임), Position, Department (/5F/Smart work/Smart Manage), E-Mail (jschoi@addpac.com), Home Phone, Mobile Phone (01026339101), and Card Serial Number (32480D32). A 'Register a Card' button is next to the Card Serial Number field. Below these fields, there are two rows for fingerprint management: 'Fingerprint 1 Serial Number' (27_1) and 'Fingerprint 2 Serial Number' (27_2). Each row has a 'Fingerprint Scan' button and a 'Delete' button. A red dashed box highlights the fingerprint management section. At the bottom, there is a 'Picture' field with a placeholder image of a person.

Extension Number	1007	(2~12 digits)
First Name		
Last Name	최진석 선임	
Position		
Department	/5F/Smart work/Smart Manage	
E-Mail	jschoi@addpac.com	
Home Phone		
Mobile Phone	01026339101	
Card Serial Number	32480D32	Register a Card
Fingerprint 1 Serial Number	27_1	Fingerprint Scan Delete
Fingerprint 2 Serial Number	27_2	Fingerprint Scan Delete
Picture		

DACM (Door Access Control Manager)

Access Log Management

The screenshot shows a web browser window displaying the 'Door Access Control System' interface. The page title is 'Door Access Control System' and the URL is '172.16.1.19/dacm/eventLog'. The user is logged in as 'Administrator'. A notification banner at the top right states 'Access control setting changed' with a link to 'Apply setting, click here to transmitting to terminal.' The main content area is titled 'Event Log' and includes a search form with fields for 'Duration' (11-07-10 to 11-08-09), 'User Extension Number', and 'Event Level' (set to 'Error'). Below the search form is a table of event logs with columns for 'Time', 'Level', 'User Extension', and 'Event'. The table contains 7 entries. At the bottom of the page, there is a pagination control showing 'Page 1 of 1' and a 'Total: 7' indicator. The footer includes the 'AddPac' logo and 'Copyright © 2011 AddPac Technology, Inc.'

	Time	Level	User Extension	Event
1	2011-07-15 10:27:27	Warning	1000	authentication failure
2	2011-07-15 11:25:27	Notice	1000	registration success
3	2011-07-15 12:21:27	Notice	1200	registration success
4	2011-07-16 09:27:27	Information	1201	door opened
5	2011-07-16 11:27:27	Information	1007	registration success
6	2011-07-16 17:12:00	Notice		security profile downloading completed
7	2011-07-17 18:00:00	Notice		system started



Time Attendance Web Manager Software (TAAM)

TAAM (Time and Attendance Manager)

Monthly Attendance Rules

Door Access Control System

172.16.1.19/dacm/monthlyWorkRuleList

Monthly Attendance Rule List

Shows list of monthly based attendance rule for time(week, full day off, national holiday)

Name	Description
1 Default Rule	Default attendance rule
2 Head Office Rule	Head office work monthly rule
3 Factory First Rule	Factory first work monthly rule
4 Factory Second Rule	Factory second work monthly rule

1. Monthly Rule

Defines day off or work day from starting first week to sixth week of the month. Each day of the week can be applied to daily-based attendance rule.

Rule Name*

Description

1st week: Sun Mon Tue Wed Thu Fri Sat

2nd week: Sun Mon Tue Wed Thu Fri Sat

3rd week: Sun Mon Tue Wed Thu Fri Sat

4th week: Sun Mon Tue Wed Thu Fri Sat

5th week: Sun Mon Tue Wed Thu Fri Sat

6th week: Sun Mon Tue Wed Thu Fri Sat

*Clicked: Full Day Off *Non-Clicked: Work Day

Sunday: N/A

Monday: N/A

Tuesday: N/A

Wednesday: N/A

Thursday: N/A

Friday: N/A

Saturday: N/A

2. Holiday Rule

Defines rule for non-working day such as national holiday, user defined holiday in the day template.

Day Template List	
Name	Description
public holiday	public holiday description
company holiday	company holiday description

List of applied Day Templates	
Name	Description

Annotations:

- Day of week rule from 1st week to 6th week and grey color means full day off, other color is work day
- You can specify daily rule from the list for sunday through saturday

AddPac Copyright © AddPac 1999-2011 All Rights Reserved

TAAM (Time and Attendance Manager)

Business Trip and Vacation

The screenshot shows the 'Business Trip and Vacation' section of the TAAM application. It features a table with two entries: a business trip and a vacation. Annotations explain that multiple users can be specified for each entry and that extension users are not processed as absentees during the specified period.

Business Trip and Vacation
Shows list of business trip and vacation of user. Each extension user will be not processed as absentee. Also, you can correct in the attendance report by date if needed.

[Add a Business Trip and Vacation](#)

Name	Description	User	Type	Start	End	Date Created	Modify	Delete
1	Rusia Business...	Total 2 includin...	Business trip	2011-09...	2011-10...			
2	Summer Vacati...		Vacation	2011-08...	2011-08...	2011-10-12 07:...		

Annotations:

- one or more user can be specified for each business trip and vacation rule.
- Extension user will be not processed as absentee between start day and end day, also log as user-defined time attendance code
- user-defined time and attendance code for attendance report or log correction

Page 1 of 1 Total: 2

AddPac Copyright © AddPac 1999-2011 All Rights Reserved Version 1.1.14

TAAM (Time and Attendance Manager)

Time and Attendance Codes

The screenshot shows a web browser window with the URL `172.16.1.19/dacm/timeAttendanceCodeList`. The page title is "Time and Attendance Manager" and the user is logged in as "root". The main content area is titled "Time and Attendance Codes" and includes a description: "Shows list of user defined attendance code which can be used as correction in the attendance report." Below this is a table with columns: Name, Description, Date Created, Modify, and Delete. A "Add a Code" button is located to the right of the table. The table contains 10 rows of codes, with the first 9 rows highlighted by a dashed yellow box. A yellow callout box points to the first three rows (Unknown, Not yet defined, Late In) with the text: "system built-in time and attendance code is provided as default, for example late-in, early-out and absence". Another yellow callout box points to the "Delete" column of the "Sick Leave" row with the text: "only user-define code can be removed if needed". A third yellow callout box points to the entire table with the text: "show built-in and user-defined time and attendance code which will be used in the attendance report and log correction".

Name	Description	Date Created	Modify	Delete
1 Unknown				
2 Not yet defined				
3 Late In				
4 Early Out				
5 Absence				
6 Late In/Early Out				
7 Normal				
8 Vacation				
9 Business trip				
10 Sick Leave	Sick Leave code by admin	2011-11-07 14:44:15		

TAAM (Time and Attendance Manager)

Delivery Policy for Attendance Report

1. Report Policy
Defines email delivery policy for manager or each user to receive daily, monthly attendance report.

Send reports to the particular person every day at 08:00

Send reports to the particular person at specific day (28) of every month. 08:00

User List
Search Field: Last Name

Name	Department	Extension
batista Eike	/2F/	1000
Stefan Persson	/2F/	1016

Applied user list

Name	Department	Extension
batista Eike	/2F/	1000
Stefan Persson	/2F/	1016

Send personal monthly report to each user.

2. SMTP Server
You can specify sending email server(SMTP) configurations.

SMTP Server: 61.33.161.2

Sender Email Address: dacs_admin@company.com

Server Authentication Required

User ID: admin

Password: ****

To apply this features, select 'Apply' or 'Cancel'

Apply Cancel

manager level users (extension) list who want to receive daily and monthly attendance report

if checked, system will send personal attendance report of each month to extension user

TAAM (Time and Attendance Manager)

Attendance Report by Date

Time and Attendance Manager
 Home | Policy | Trip and Vacation | Report Configuration | Report View

Attendance Report by Date
 Shows attendance log for each user and summary information with specified day.

Select Date : 2011-10-19
 Select Department : All

Attendance Report by Date (2011-10-19)

Summary:

Type	Count
Late In	1
Early Out	1
Normal	10

Table:

	Username	Department	In	Out	Overtime	Office Hc	Result	Correction Ti	Correct
1	Eike batista	smart management팀	08:05:00	18:05:00	0 hr	10:0...	Normal		
2	Bill Gates	multimedia팀	09:15:00	17:15:00	0 hr	08:0...	Normal	2011-11-...	
3	Larry Ellison	multimedia팀	09:00:00	18:00:00	0 hr	09:0...	Normal		
4	karl Albrecht	smart framework팀	09:00:00	17:00:00	0 hr	08:0...	Early Out		
5	Carlos Slim Helu	smart management팀	09:10:00	19:10:00	0 hr	10:0...	Normal		
6	Lakshmi Mittal	multimedia팀	09:00:00	18:00:00	4 hr	09:0...	Normal		
7	Christy Walton	smart framework팀	09:00:00	18:00:00	0 hr	09:0...	Normal		

You can export to excel or print out for attendance report

attendance summary for each time and attendance code with specified date

administrator may adjust or correct attendance log which system have processed if necessary

TAAM (Time and Attendance Manager)

Attendance Report Excel Export

Attendance Report by Date (2011-10-19)							
Username	Department	In	Out	Overtime	Office Hours	Result	Correction Time
Eike batista	smart management	08:05:00	18:05:00	0 hr	10:00:00	Normal	
Bill Gates	multimedia	09:15:00	17:15:00	0 hr	08:00:00	Normal	2011-11-07 14:52:28
Larry Ellison	multimedia	09:00:00	18:00:00	0 hr	09:00:00	Normal	
karl Albrecht	smart framework	09:00:00	17:00:00	0 hr	08:00:00	Early Out	
Carlos Slim Helu	smart management	09:10:00	19:10:00	0 hr	10:00:00	Normal	
Lakshmi Mittal	multimedia	09:00:00	18:00:00	4 hr	09:00:00	Normal	
Christy Walton	smart framework	09:00:00	18:00:00	0 hr	09:00:00	Normal	
Lika Shing	smart framework	09:20:00	18:20:00	0 hr	09:00:00	Late In	
Stefan Persson	smart framework	09:00:00	20:00:00	2 hr	11:00:00	Normal	
Warren Buffett	multimedia	09:15:00	18:15:00	0 hr	09:00:00	Normal	
Amancio Ortega	smart management	09:00:00	21:00:00	3 hr	12:00:00	Normal	
Mukesh Ambani	smart management	09:00:00	18:30:00	0 hr	09:30:00	Normal	

TAAM (Time and Attendance Manager)

Attendance Report by Month

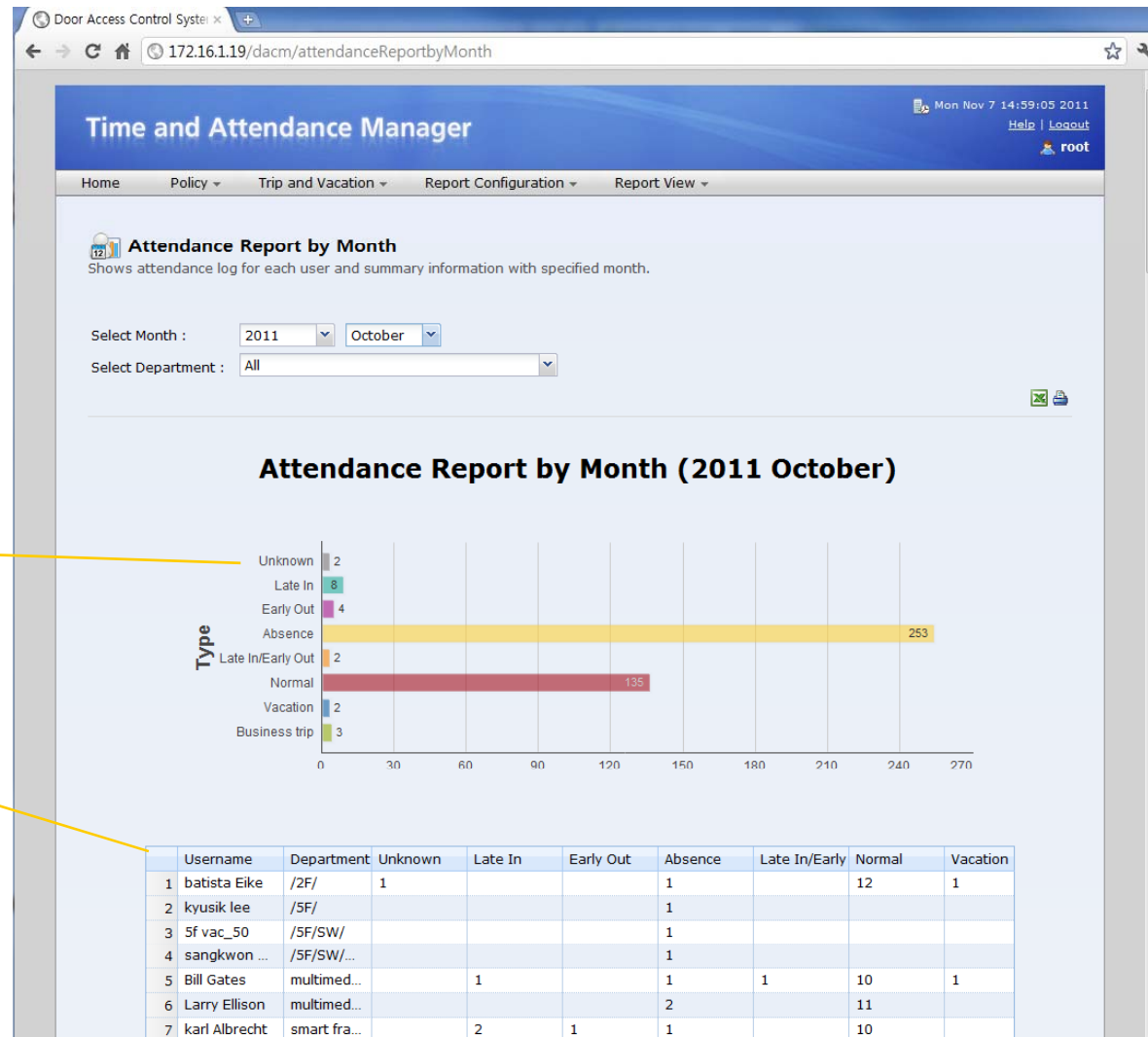

attendance summary for each time and attendance code with specified month

attendance summary for each extension user

TAAM (Time and Attendance Manager)

Attendance Daily Report by Month

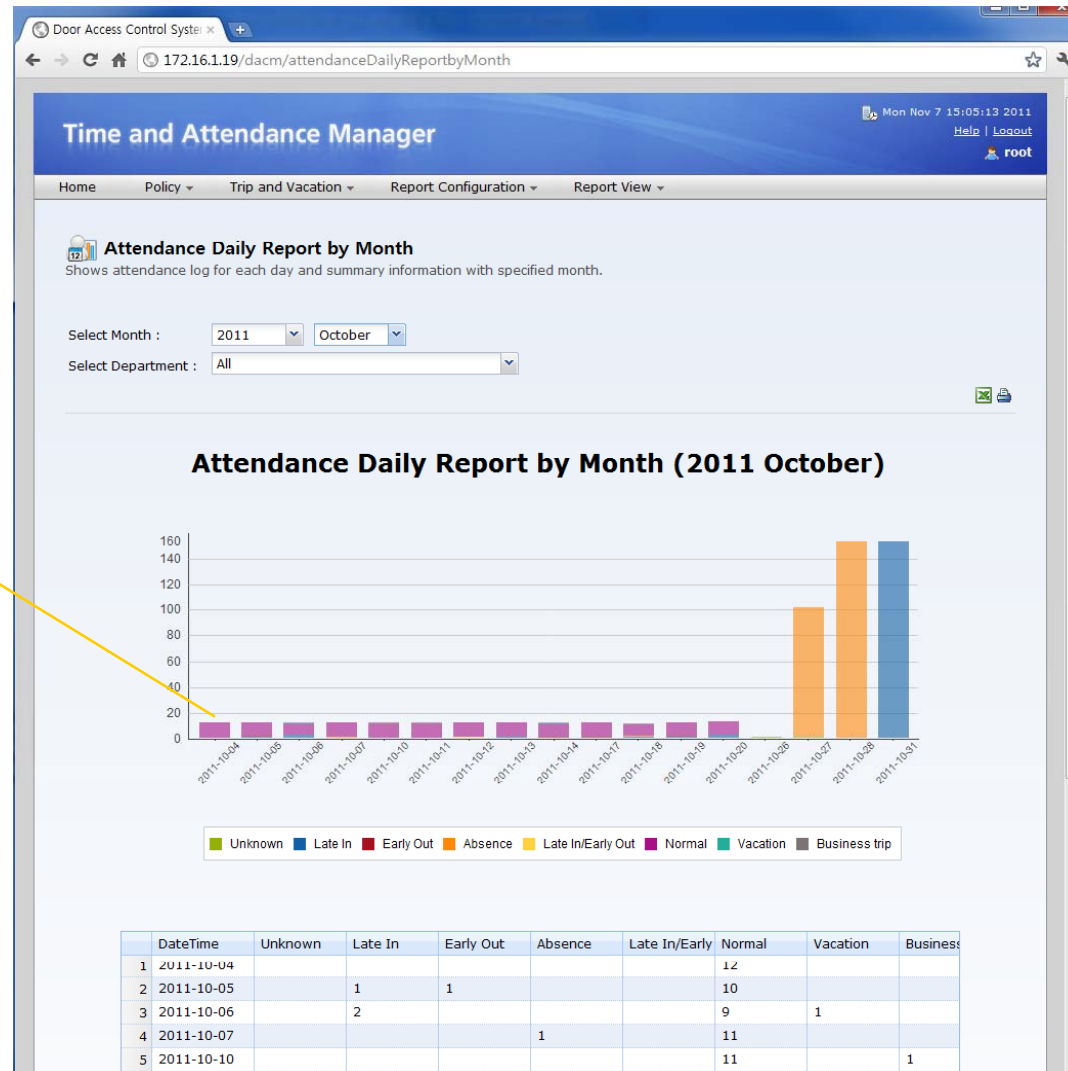

clustered column of attendance summary with time span from first to end of the month



Door Access Control Server Open API

Open API

Open API for 3'rd Party Management System

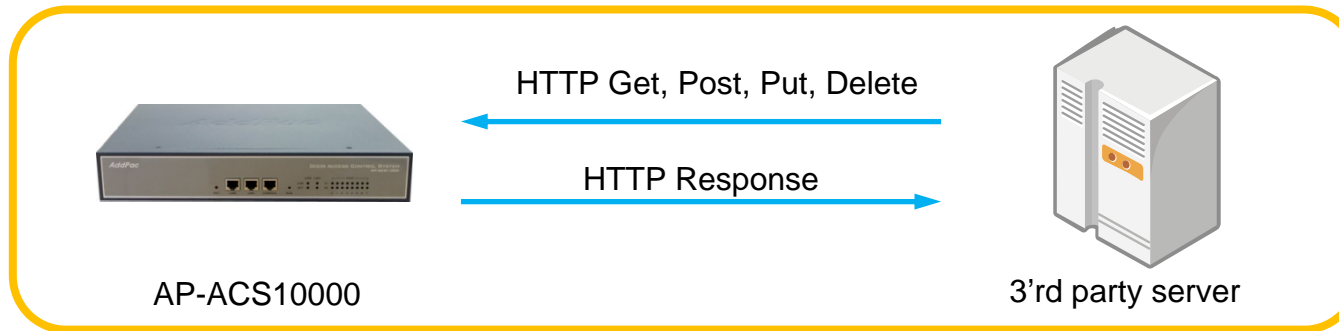

- HTTP based RESTful Open API for Door Access Management
- XML based Flexible and Expandable Message Contents
- Provides More than 40 APIs as Bellow
 - user_list(GET), user(GET, POST, PUT, DELETE), ...
 - terminal_list(GET), terminal(GET, POST, PUT, DELETE), ...
 - access_group(GET, POST, PUT, DELETE), priority (PUT), ...
 - card_list(GET), card(POST, PUT, DELETE), ...
 - schedule_template(GET, POST, PUT, DELETE), rule(GET, POST, PUT, DELETE) ,...



Thank you!

AddPac Technology Co., Ltd.
Sales and Marketing

Phone +82.2.568.3848 (KOREA)

FAX +82.2.568.3847 (KOREA)

E-mail : sales@addpac.com