

# AP-ACS1000

## Door Access Control Server

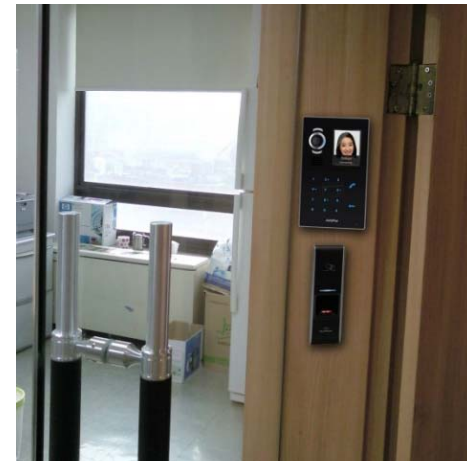

AP-ACS1000  
(Door Access Control Server)



**AddPac**

**AddPac Technology**

Sales and Marketing

# Contents

- DACS(Door Access Control System) Network Diagram
- AP-ACS1000 DACS Main Features
- AP-ACS1000 DACS Hardware Specification
- DACS System Message Flow (Examples)
- DACM (Door Access Control Manager)
- Open API for Third Party Controller
- IP Video Door Phone Comparison Table

# Integrated Door Access Control and Call Control

## AP-ACS1000 DACS (Door Access Control System)

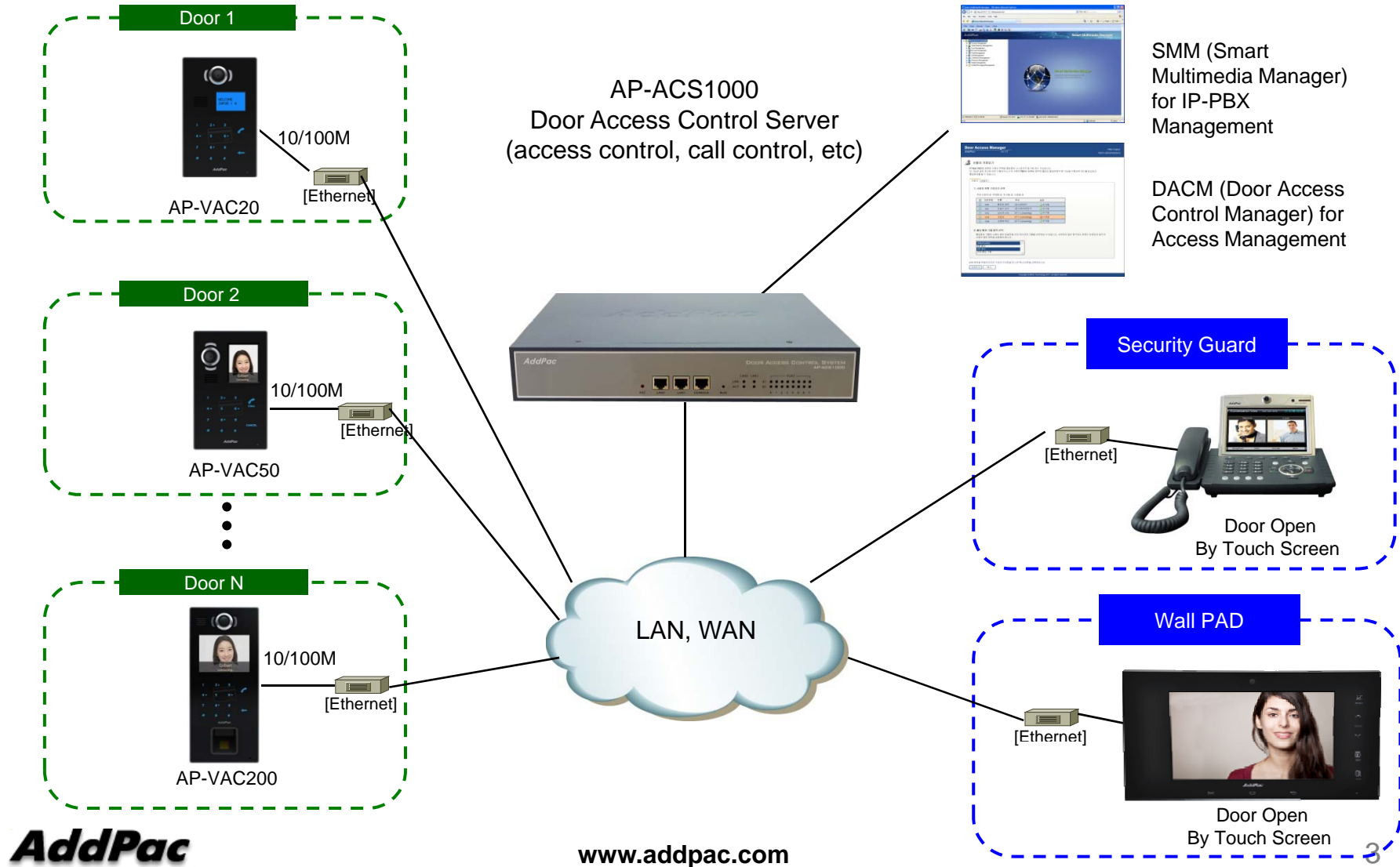

# IP-PBX Environment

## AP-ACS1000 DACS (Door Access Control System)

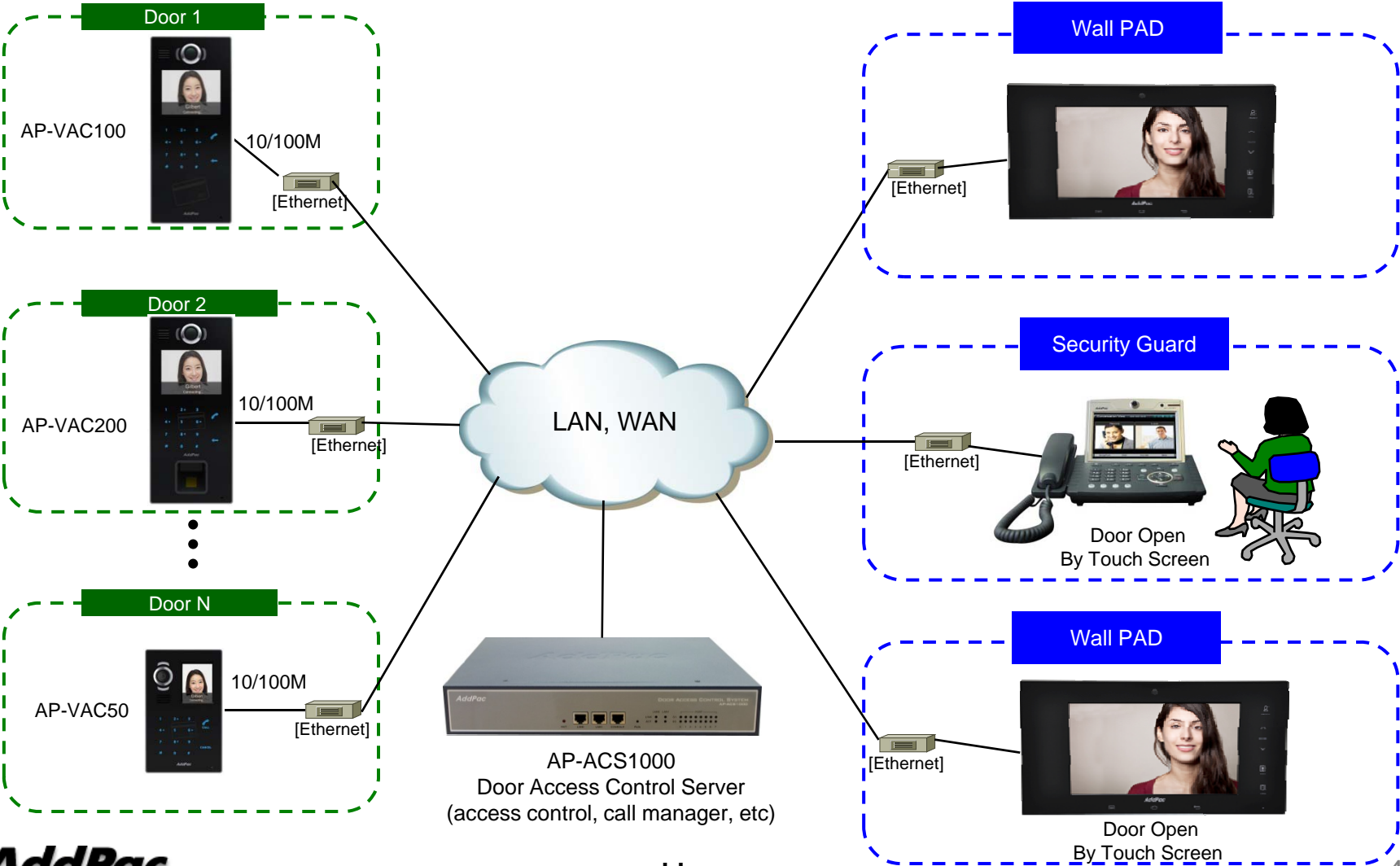

# Main Features

## AP-ACS1000 DACS (Door Access Control System)

- Door Access Control Application System
- SIP Application Server, Proxy, Registrar and Location Server
- Multiple ITSP Trunk with SIP & H.323 Accounts Support
- Legacy PBX Interworking Service
- High Performance RISC & Programmable DSP Architecture
- Two(2) 10/100Mbps Fast Ethernet (IP Share ,etc)
- High Performance LAN-to-LAN Routing Capability
- Powerful Network Protocols (PPPoE, DHCP, Static Routing, etc)
- IPv4/IPv6 Dual Stack
- Firmware Upgradeable Architecture
- Smart Multimedia Manager for IP-PBX Management
- DACM(Door Access Control Manager)
- Advanced Voice QoS Mechanism
- Small, Light and Compact Design
- Two(2) VoIP Module Slots for Analog, Digital Interface

# Main Features

## AP-ACS1000 DACS (Door Access Control System)

- RISC Microprocessor Computing Power
- Main Chassis
  - Network Interface
    - Two(2) 10/100Mbps Fast Ethernet
    - One(1) RS-232C Console (RJ45)
  - Two(2) VoIP Module Slots for FXS, FXO etc



# Hardware Specification

AP-ACS1000 DACS (Door Access Control System)

AP-ACS1000 Front Side



LAN1 (10/100Mbps)

LAN0(10/100Mbps)

Console Port

[www.addpac.com](http://www.addpac.com)

# Hardware Specification

## AP-ACS1000 DACS (Door Access Control System)

### AP-ACS1000 Back Side

PSTN Interface Module

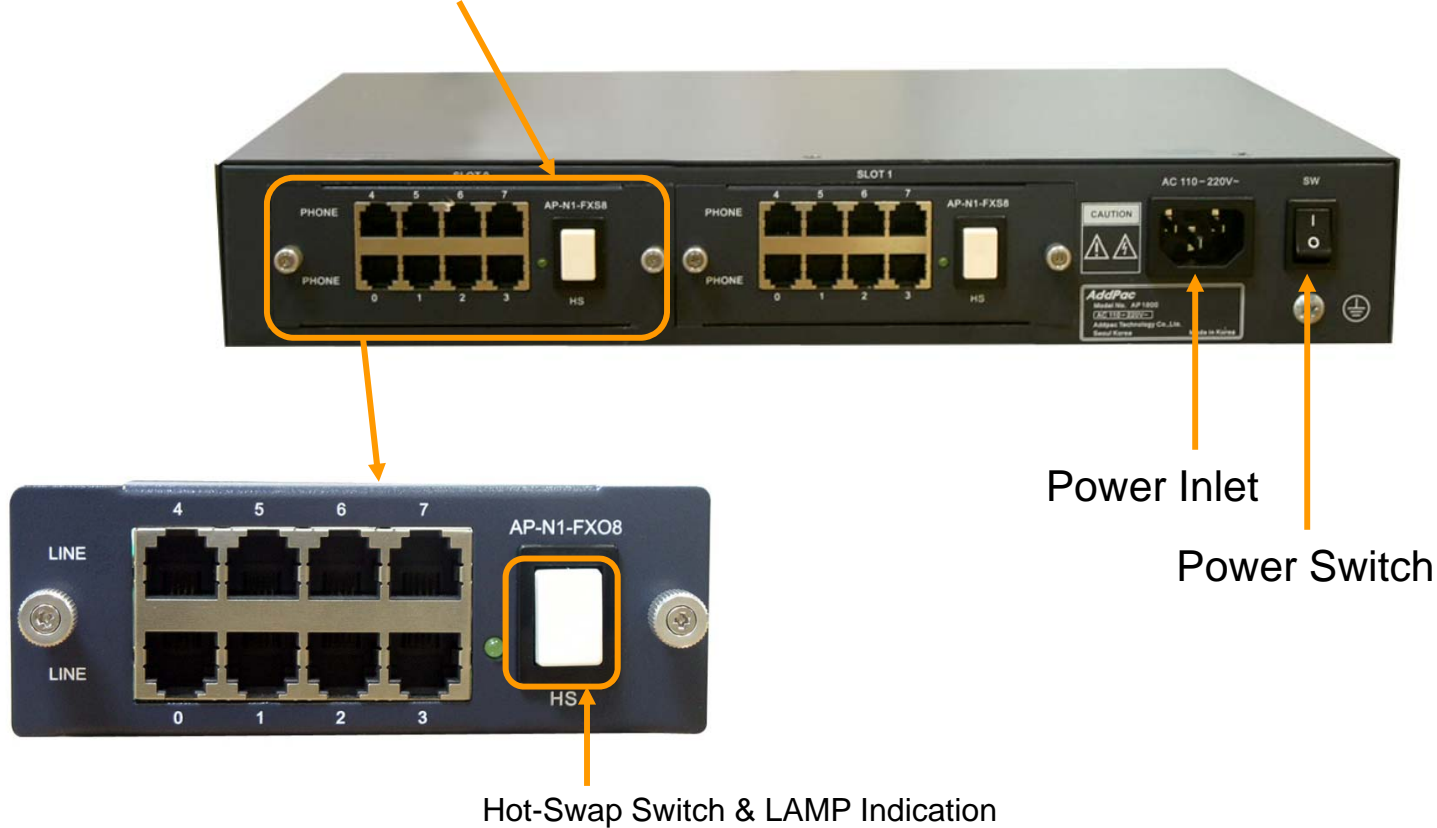







# Hardware Specification

AP-ACS1000 DACS (Door Access Control System)

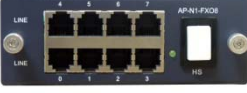
## PSTN Interface Module

<b>AP-N1-FXS8</b>	 A black 8-port FXS voice processing module with RJ11 ports numbered 0-7 and a central switch labeled 'HS'.	8-Port FXS Voice Processing Module (8 x RJ11)
<b>AP-N1-FXO8</b>	 A black 8-port FXO voice processing module with RJ11 ports numbered 0-7 and a central switch labeled 'HS'.	8-Port FXO Voice Processing Module (8 x RJ11)
<b>AP-N1-FXO4S4</b>	 A black 8-port voice processing module with 4 FXO and 4 FXS ports, numbered 0-7, and a central switch labeled 'HS'.	4-Port FXO and 4-Port FXS Voice Processing Module (8 x RJ11)
<b>AP-N1-E1T1</b>	 A black 1-port VoIP digital E1/T1 interface module with an RJ45 port and a central switch labeled 'HS'.	1-Port VoIP Digital E1/T1 Interface Module(1xRJ45)



# DACS System Message Flow

# DACS System Message Flow

## Registration and KeepAlive

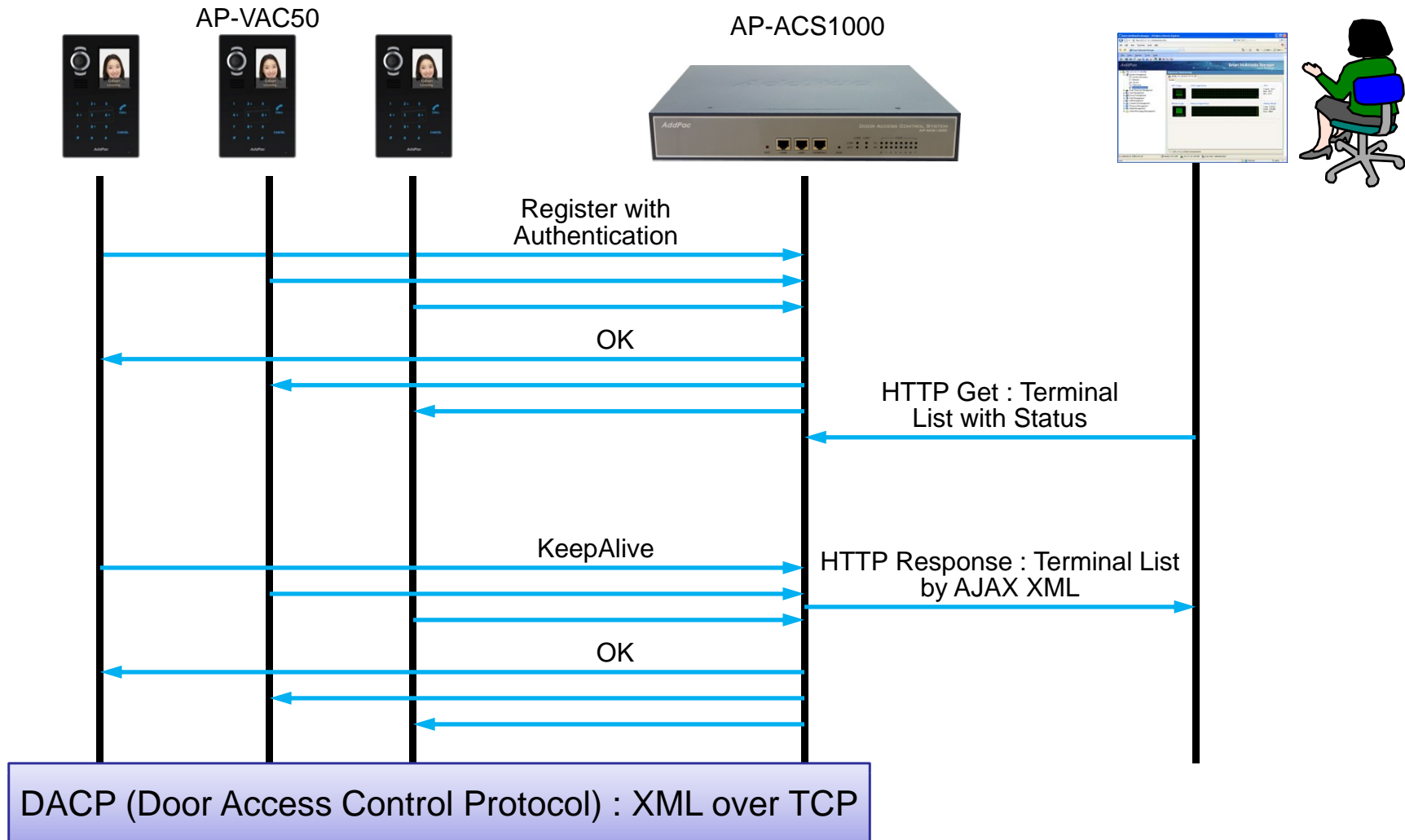

# DACS System Message Flow

## Access Privilege and Schedule Download

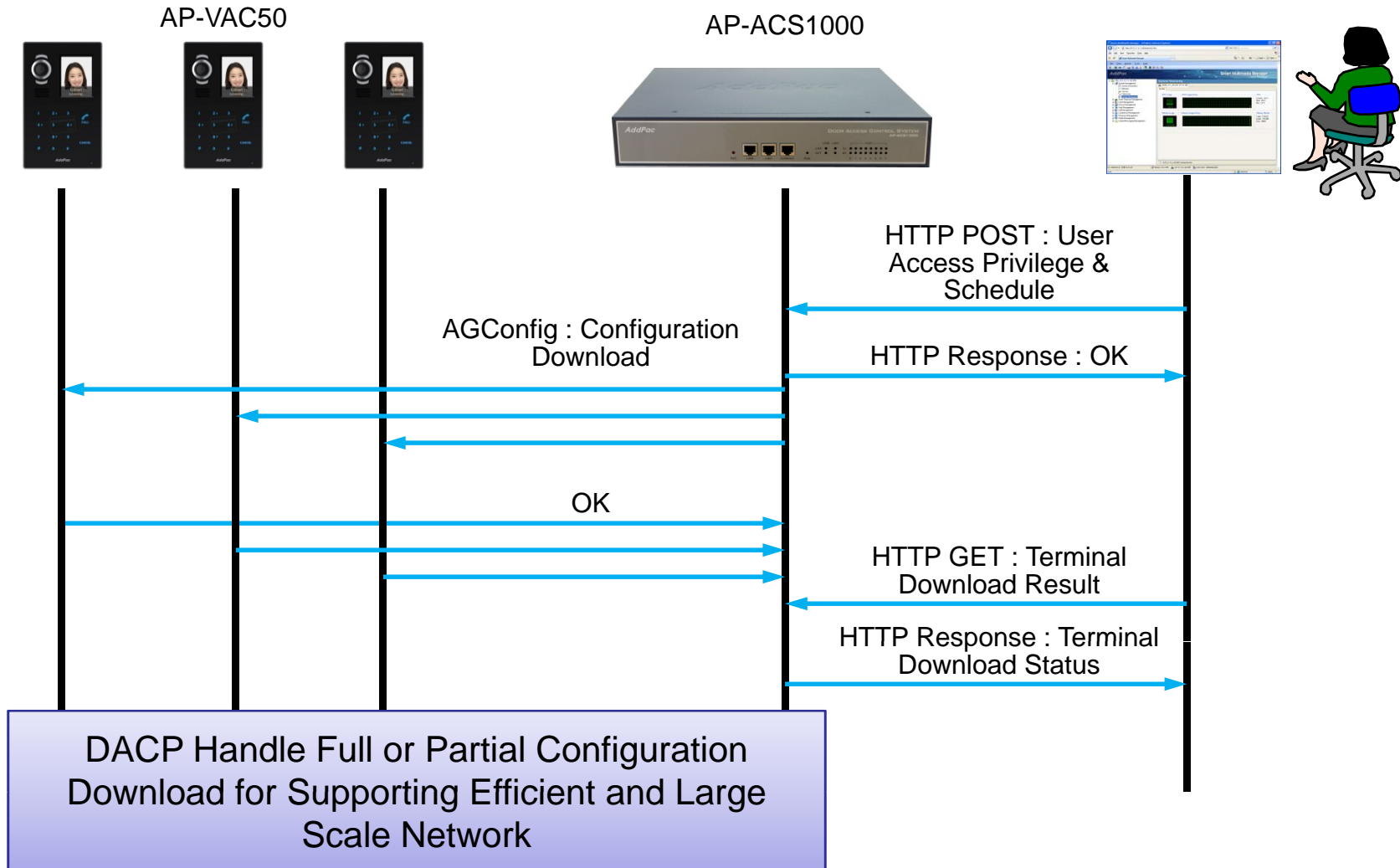

# DACS System Message Flow

## RF Card Read/Write and Registration

AP-VAC50



AP-ACS1000

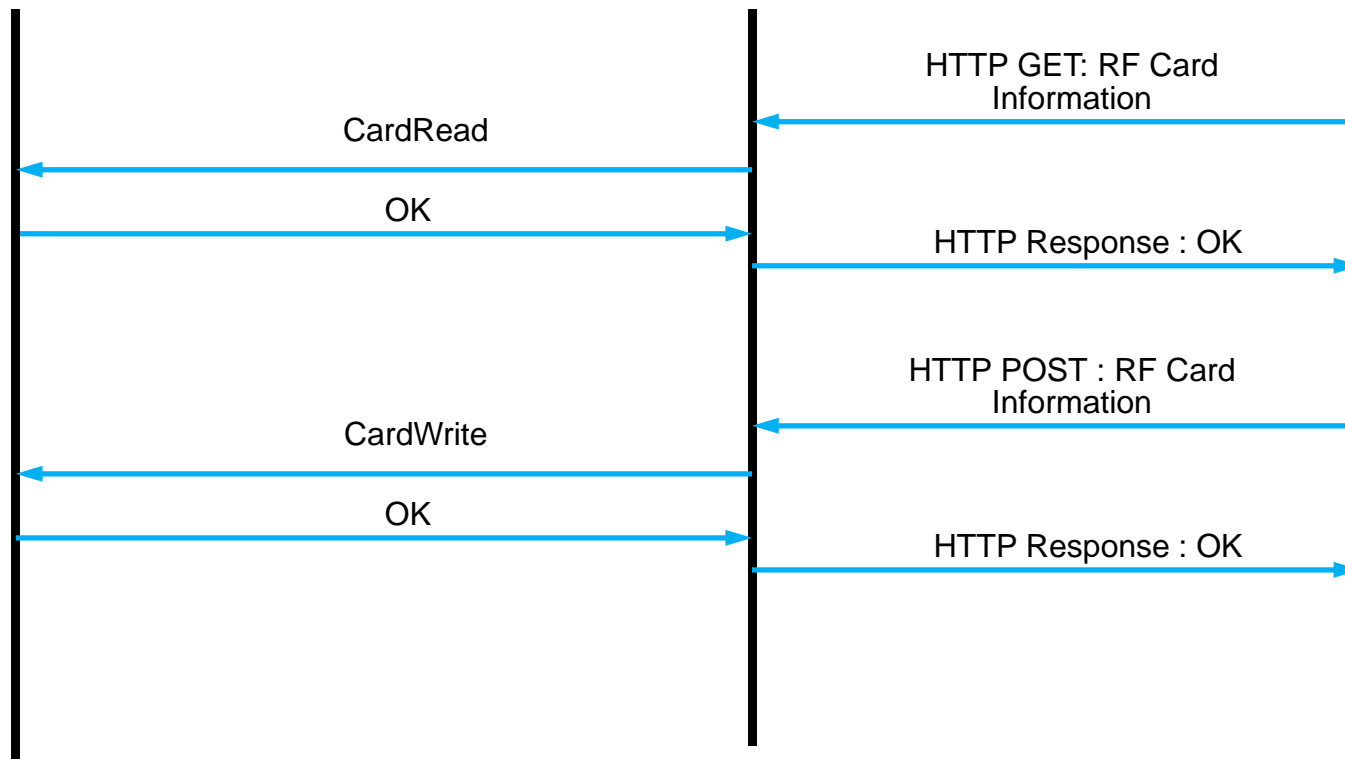
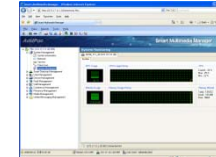

# DACS System Message Flow

## Door Open by RF Card or Password

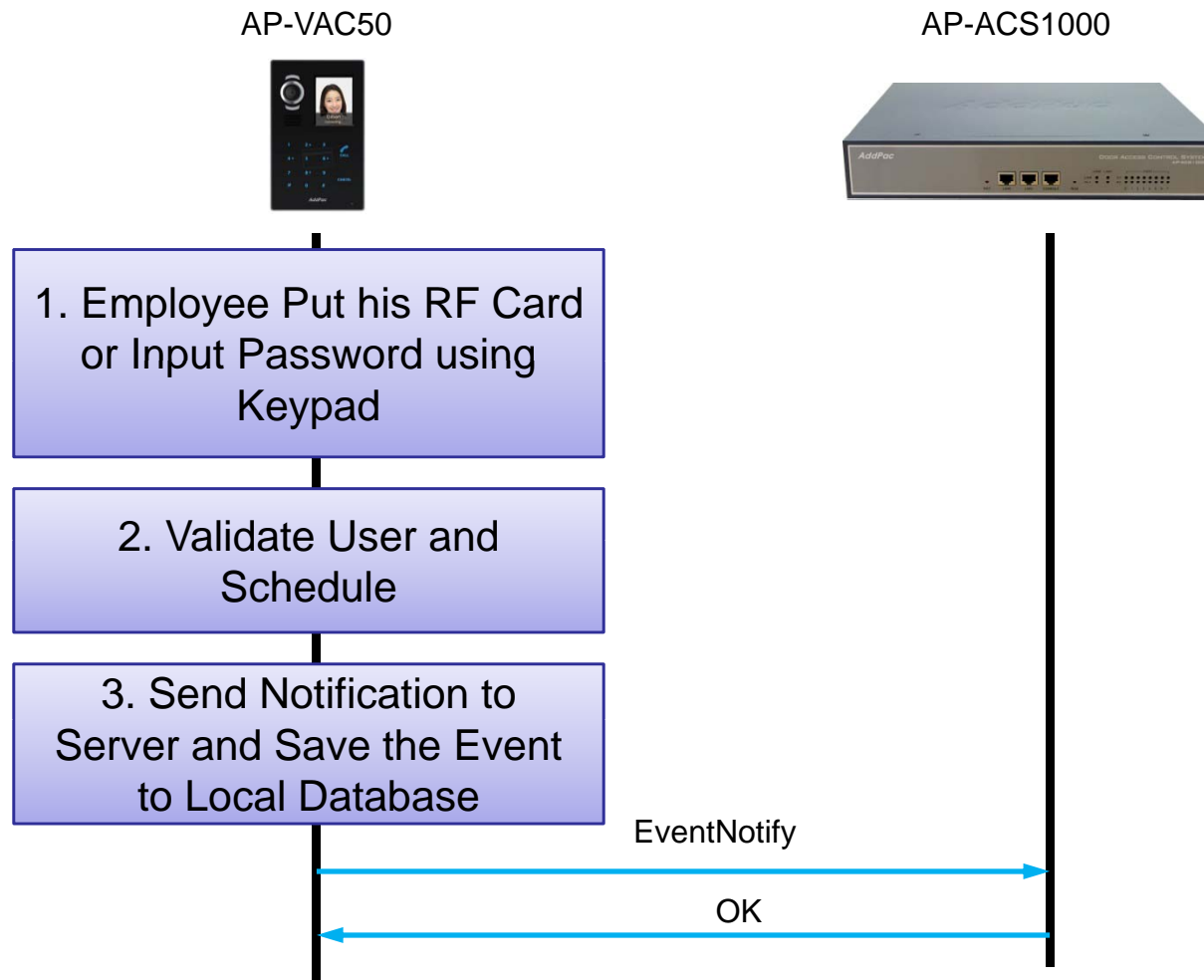

# DACS System Message Flow

## Door Open by Other Terminal

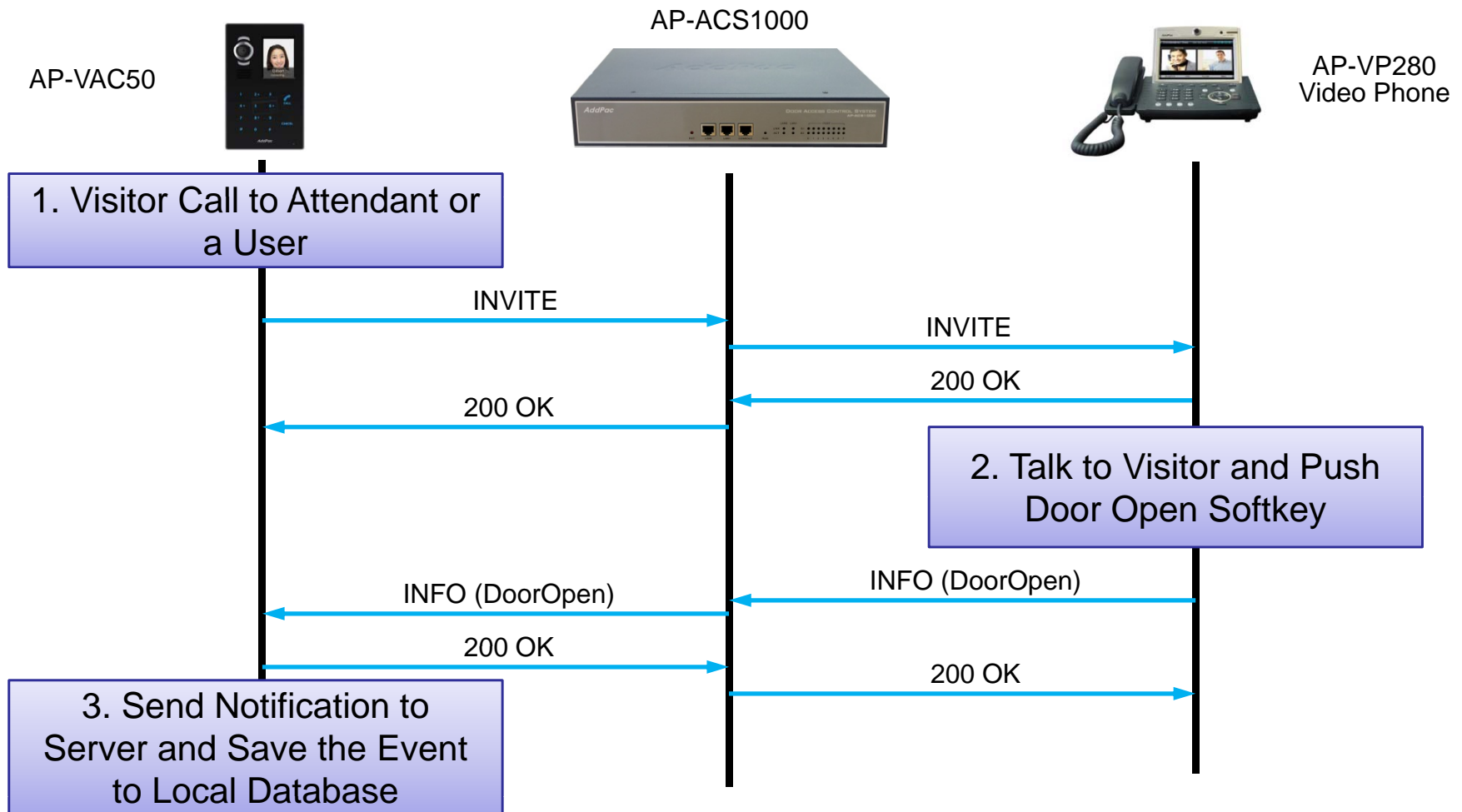



# Door Access Control Manager for AP-ACS1000



# DACM (Door Access Control Manager)

## Main Web Page

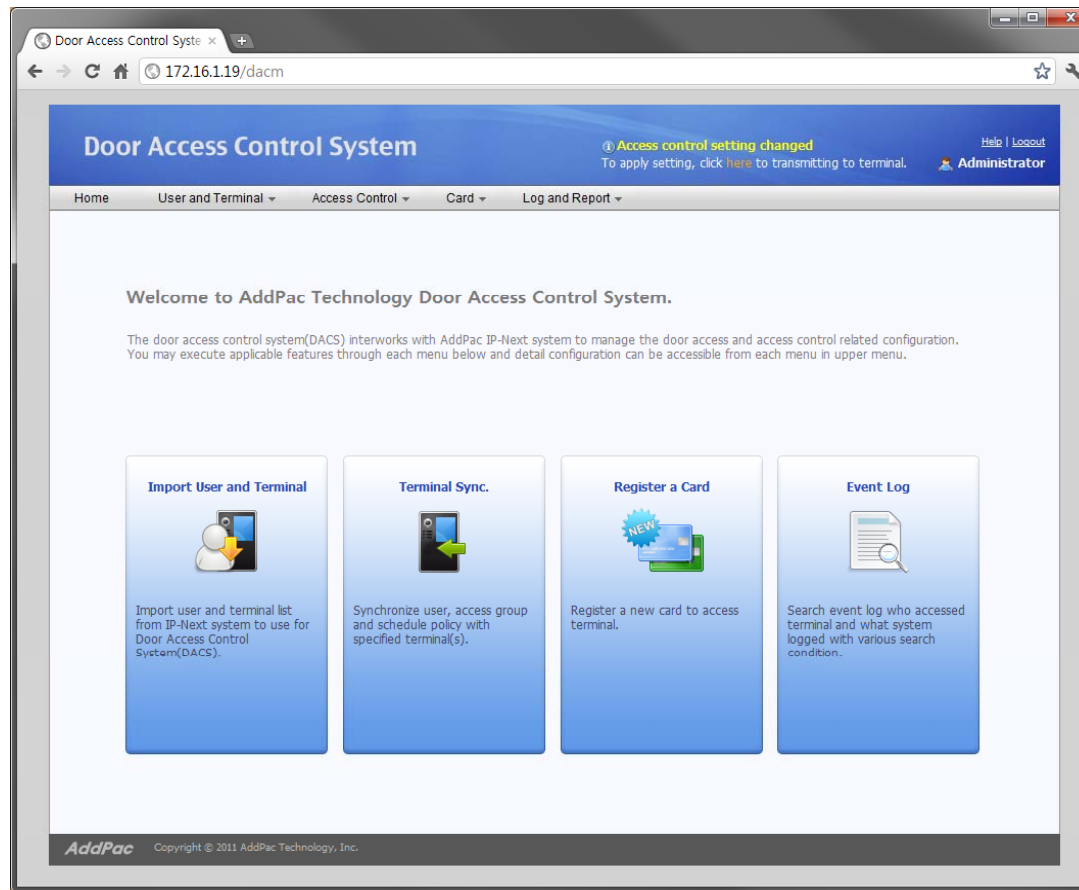

# DACM (Door Access Control Manager)

## Import User and Terminal

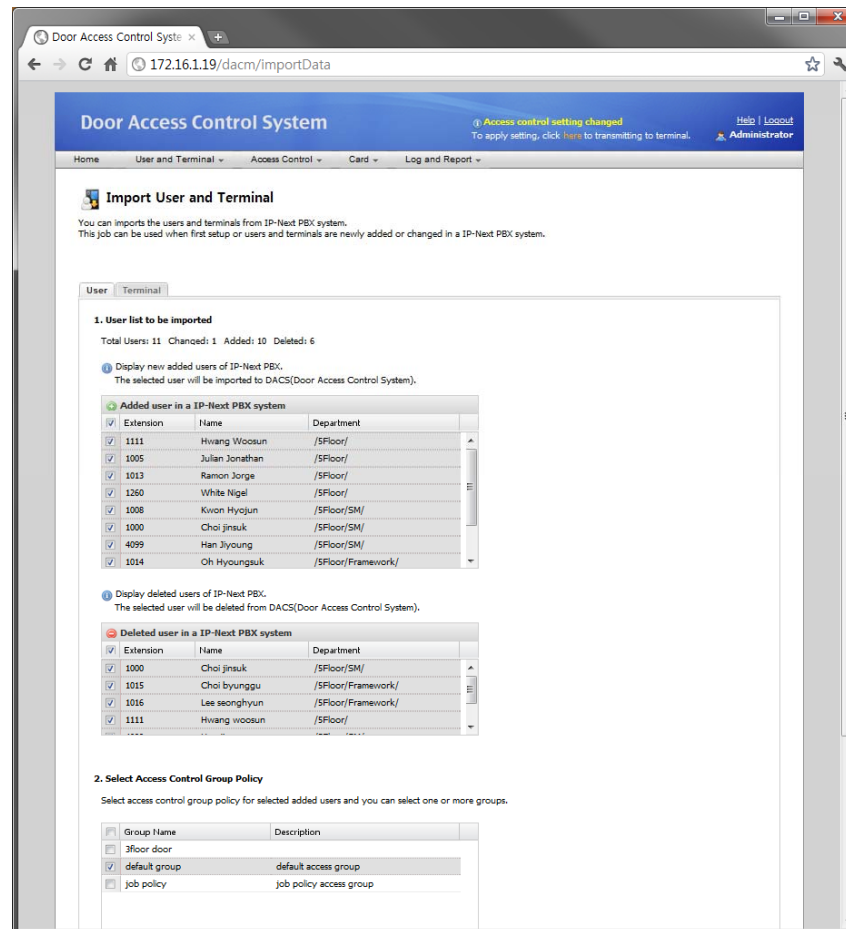

# DACM (Door Access Control Manager)

## User List

The screenshot shows a web browser window displaying the 'Door Access Control System' user list. The page title is 'Door Access Control System' and the URL is '172.16.1.19/dacm/userList'. A notification at the top right states 'Access control setting changed' with a link to 'here' and a 'Logout' button. The user is logged in as 'Administrator'. The main content area is titled 'User List' and includes a search bar with a dropdown menu set to 'All Users' and an 'Import User' button. Below the search bar is a table with the following data:

	Extension	Name	Department	Access Policy	Date Created	Modify	Delete
1	1000	Choi jinsuk	/SFloor/SM/	Access Allow	2011-07-22 15:50:01		
2	1008	Kwon hyojun	/SFloor/SM/	Access Allow	2011-07-22 15:50:00		
3	1014	Oh hyongsuk	/SFloor/Framework/	Access Allow	2011-07-22 15:50:01		
4	1015	Choi byunggu	/SFloor/Framework/	Access Allow	2011-07-22 15:50:01		
5	1016	Lee seonghyun	/SFloor/Framework/	Access Allow	2011-07-22 15:50:01		

At the bottom of the page, there is a pagination control showing 'Page 1 of 1' and a 'Total: 5' indicator. The footer contains the 'AddPac' logo and 'Copyright © 2011 AddPac Technology, Inc.'

# DACM (Door Access Control Manager)

## Terminal List

Door Access Control System

Access control setting changed  
To apply setting, click [here](#) to transmitting to terminal.

Help | Logout  
Administrator

Home User and Terminal Access Control Card Log and Report

### Terminal List

Display the registered door phone lists imported from IP-Next PBX system.

Import Terminal

	Terminal Name	Description	Status	Extension	IP Address	Model Name	Version	Date Created	Detail View
1	2floor door terminal	2Floor door ter...	Connected	1006	172.16.10.4	AP-VAC50		2011-07-29 17:08:50	
2	3floor door terminal	3Floor door ter...	Connected	1002	172.16.10.1	AP-VAC20	8.50.001	2011-07-22 15:50:01	
3	5floor door terminal	5Floor door ter...	Connected	1005	172.16.10.2	AP-VAC50		2011-07-29 17:08:50	
4	The main entrance d...	The main entran...	Connected	Required setting	172.16.10.3	AP-VAC100		2011-07-29 17:08:50	

Page 1 of 1 Total: 4

AddPac Copyright © 2011 AddPac Technology, Inc.

# DACM (Door Access Control Manager)

## Access Control Group Management

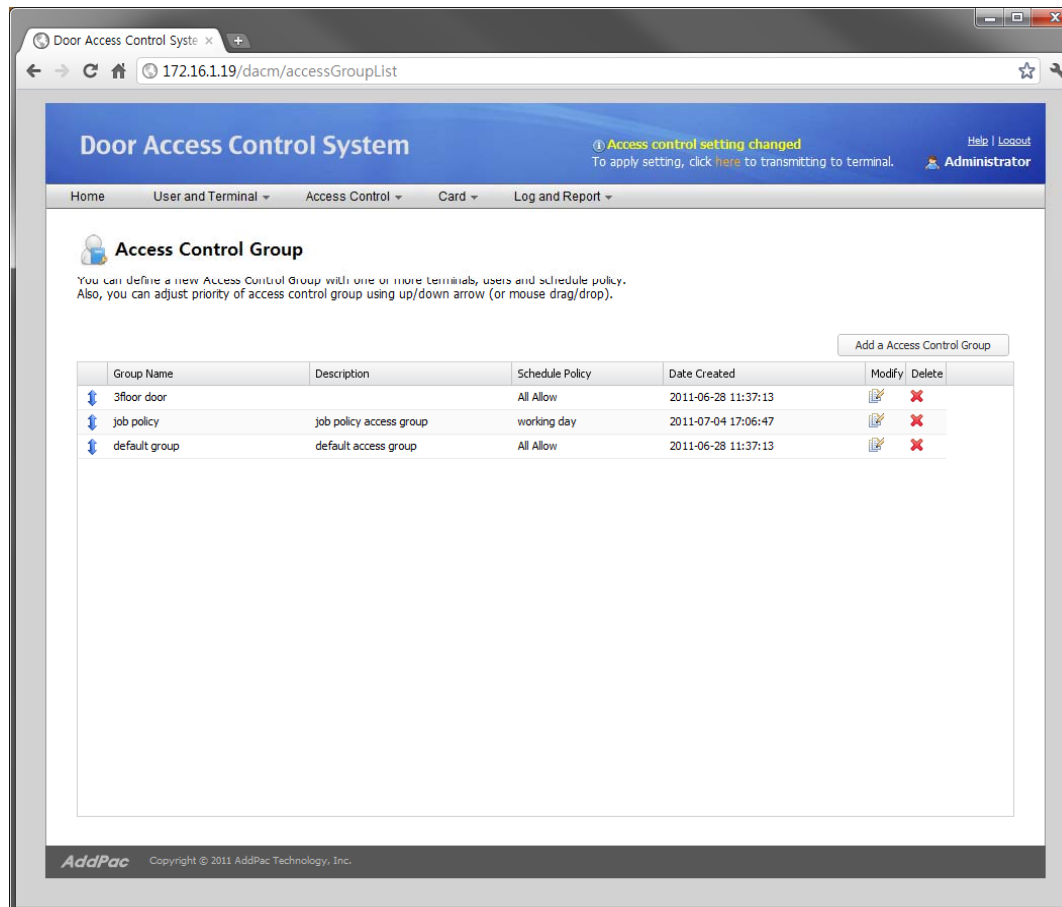

The screenshot displays the web interface for the Door Access Control System. The browser address bar shows the URL `172.16.1.19/dacm/accessGroupList`. The page title is "Door Access Control System". A notification banner at the top right indicates "Access control setting changed" and provides instructions to apply settings. The navigation menu includes "Home", "User and Terminal", "Access Control", "Card", and "Log and Report". The main content area is titled "Access Control Group" and includes a brief description: "You can define a new Access Control Group with one or more terminals, users and schedule policy. Also, you can adjust priority of access control group using up/down arrow (or mouse drag/drop)." Below this is a table listing existing groups, with columns for Group Name, Description, Schedule Policy, Date Created, Modify, and Delete. A button labeled "Add a Access Control Group" is located above the table.

Group Name	Description	Schedule Policy	Date Created	Modify	Delete
3floor door		All Allow	2011-06-28 11:37:13		
job policy	job policy access group	working day	2011-07-04 17:06:47		
default group	default access group	All Allow	2011-06-28 11:37:13		

# DACM (Door Access Control Manager)

## Configuration Download to Terminal

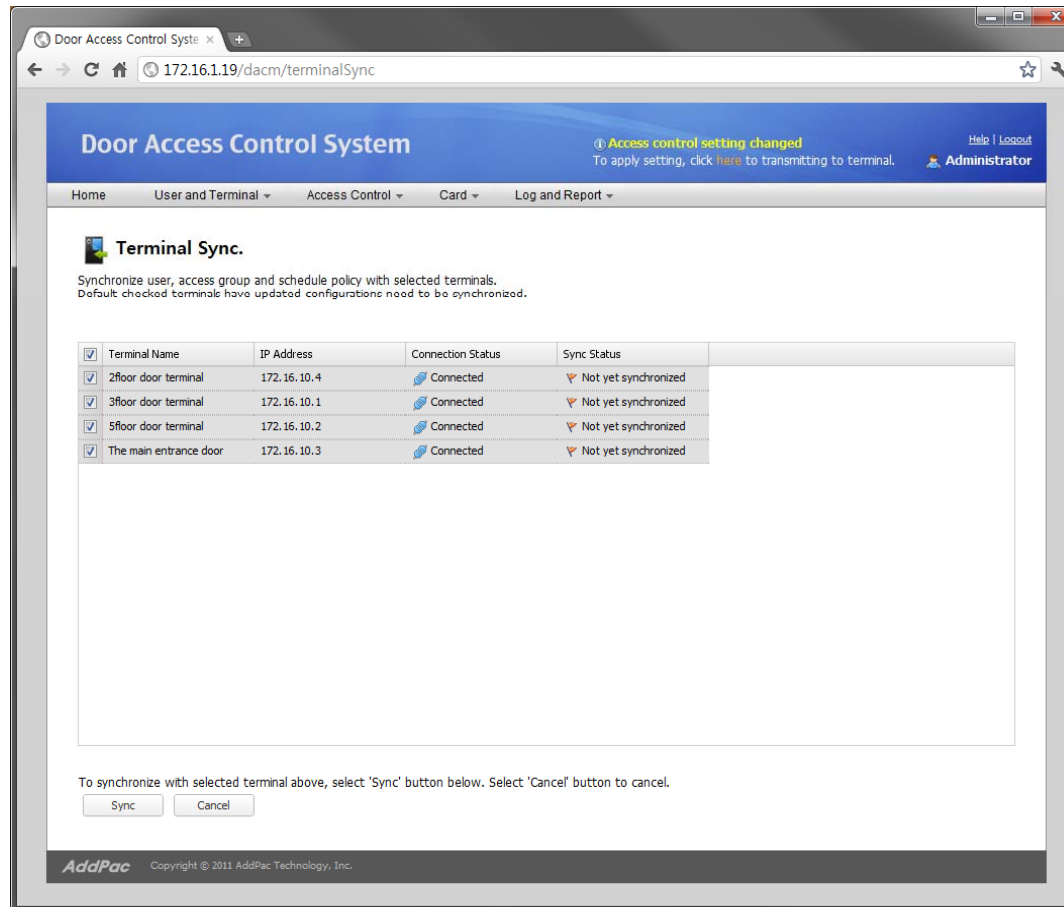

Door Access Control System

Access control setting changed  
To apply setting, click [here](#) to transmitting to terminal.

Help | Logout  
Administrator

Home User and Terminal Access Control Card Log and Report

### Terminal Sync.

Synchronize user, access group and schedule policy with selected terminals.  
Default checked terminals have updated configurations need to be synchronized.

<input checked="" type="checkbox"/>	Terminal Name	IP Address	Connection Status	Sync Status
<input checked="" type="checkbox"/>	2floor door terminal	172.16.10.4	Connected	Not yet synchronized
<input checked="" type="checkbox"/>	3floor door terminal	172.16.10.1	Connected	Not yet synchronized
<input checked="" type="checkbox"/>	5floor door terminal	172.16.10.2	Connected	Not yet synchronized
<input checked="" type="checkbox"/>	The main entrance door	172.16.10.3	Connected	Not yet synchronized

To synchronize with selected terminal above, select 'Sync' button below. Select 'Cancel' button to cancel.

AddPac Copyright © 2011 AddPac Technology, Inc.

# DACM (Door Access Control Manager)

## RF Card Management

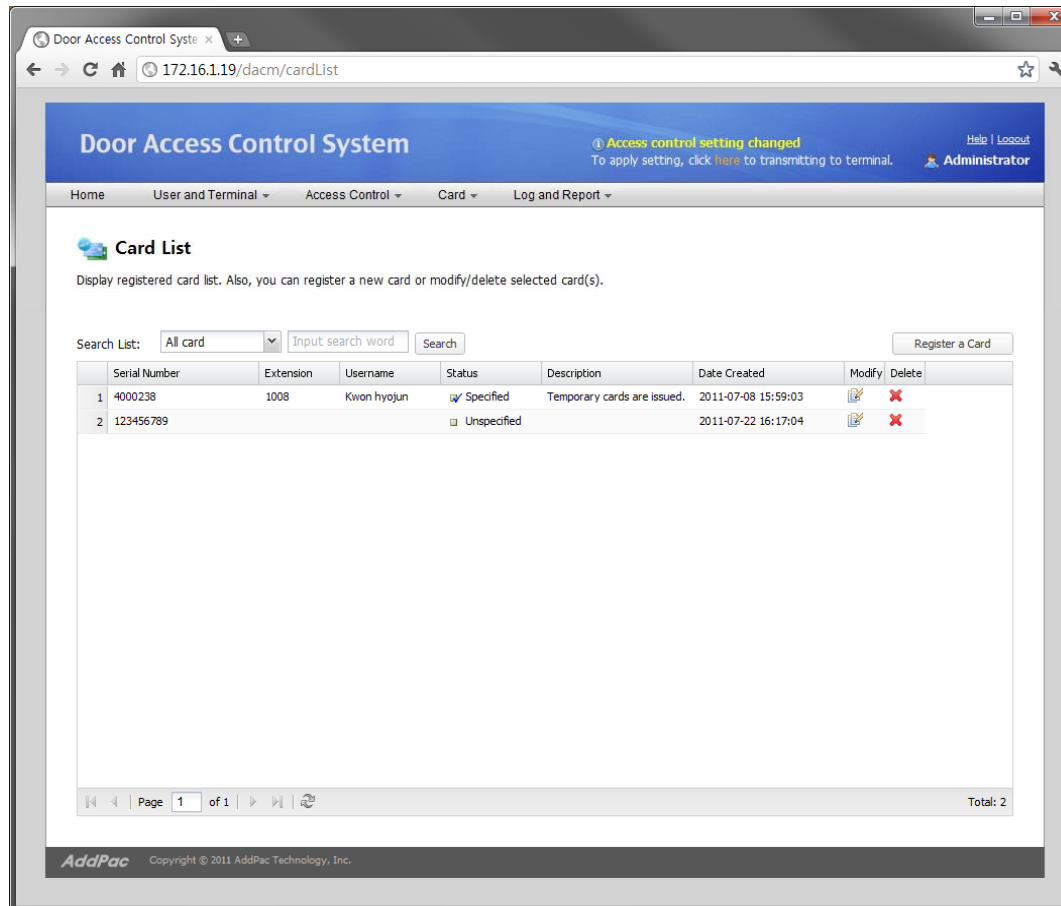

The screenshot displays the 'Door Access Control System' web interface. The browser address bar shows '172.16.1.19/dacm/cardList'. The page title is 'Door Access Control System'. A notification banner at the top right states 'Access control setting changed' with instructions to click a link to transmit settings to the terminal. The user is logged in as 'Administrator'. The main navigation menu includes 'Home', 'User and Terminal', 'Access Control', 'Card', and 'Log and Report'. The 'Card List' section is active, displaying a table of registered cards. The table has columns for Serial Number, Extension, Username, Status, Description, Date Created, Modify, and Delete. Two cards are listed: one with Serial Number 4000238, Extension 1008, Username Kwon hyojun, Status Specified, and Date Created 2011-07-08 15:59:03; and another with Serial Number 123456789, Extension (blank), Username (blank), Status Unspecified, and Date Created 2011-07-22 16:17:04. A search bar and a 'Register a Card' button are also visible.

Serial Number	Extension	Username	Status	Description	Date Created	Modify	Delete
1 4000238	1008	Kwon hyojun	✓ Specified	Temporary cards are issued.	2011-07-08 15:59:03		
2 123456789			☐ Unspecified		2011-07-22 16:17:04		

# DACM (Door Access Control Manager)

## Access Log Management

The screenshot shows a web browser window displaying the 'Door Access Control System' interface. The page title is 'Door Access Control System' and the URL is '172.16.1.19/dacm/eventLog'. The user is logged in as 'Administrator'. A notification banner at the top right states 'Access control setting changed' with a link to 'Apply setting, click here to transmitting to terminal.' The main content area is titled 'Event Log' and includes a search filter section with fields for 'Duration' (11-07-10 to 11-08-09), 'User Extension Number', and 'Event Level' (set to 'Error'). Below the search filters is a table of event logs.

	Time	Level	User Extension	Event
1	2011-07-15 10:27:27	Warning	1000	authentication failure
2	2011-07-15 11:25:27	Notice	1000	registration success
3	2011-07-15 12:21:27	Notice	1200	registration success
4	2011-07-16 09:27:27	Information	1201	door opened
5	2011-07-16 11:27:27	Information	1007	registration success
6	2011-07-16 17:12:00	Notice		security profile downloading completed
7	2011-07-17 18:00:00	Notice		system started

The interface also includes a pagination bar at the bottom of the table showing 'Page 1 of 1' and a total count of 'Total: 7'. The footer of the page contains the 'AddPac' logo and 'Copyright © 2011 AddPac Technology, Inc.'





# AP-ACS1000 Open API

# Open API

## Open API for 3'rd Party Management System

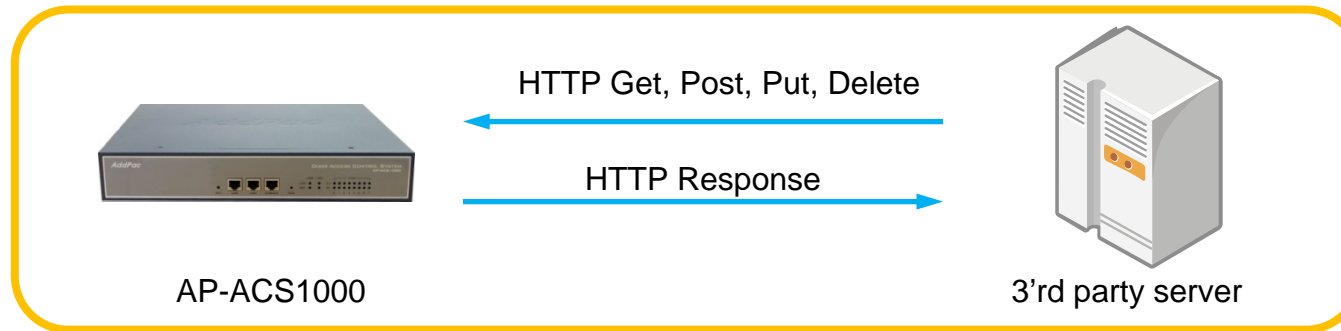

- HTTP based RESTful Open API for Door Access Management
- XML based Flexible and Expandable Message Contents
- Provides More than 40 APIs as Bellow
  - user\_list(GET), user(GET, POST, PUT, DELETE), ...
  - terminal\_list(GET), terminal(GET, POST, PUT, DELETE), ...
  - access\_group(GET, POST, PUT, DELETE), priority (PUT), ...
  - card\_list(GET), card(POST, PUT, DELETE), ...
  - schedule\_template(GET, POST, PUT, DELETE), rule(GET, POST, PUT, DELETE) ,...



# IP Video Door Phones





# IP Video Door Phone Comparison Table

Model	AP-VAC200	AP-VAC100	AP-VAC50	AP-VAC20
Service Features				
Duplex (Voice)	Full Duplex	Full Duplex	Full Duplex	Full Duplex
Key Pad	3x4 Key Support	3x4 Key Support	3x4 Key Support	3x4 Key Support
LCD	3.5 Inch	3.5 Inch	2inch LCD	Graphic LCD
RF Card	Support	Support	Support	Support
Fingerprint	N/A	N/A	N/A	N/A
Video Codec	H.264/MPEG4	H.264/MPEG4	H.264/MPEG4	H.264/MPEG4
Voice Codec	G.711	G.711	G.711	G.711
Signaling	H.323/SIP	H.323/SIP	H.323/SIP	H.323/SIP
MIC & Speaker Phone	Support	Support	Support	Support
LAN Port	1	1	1	1
PoE(Optional)	Support	Support	Support	Support

# IP Video Door Phone Comparison Table

Model	AP-VAC150	AP-VAC80
Service Features		
Duplex (Voice)	Full Duplex	Full Duplex
Key Pad	Touch Screen based Key Support	Touch Screen based Key Support
LCD	5 Inch LCD	5 inch LCD
RF Card	Support	Support
Fingerprint	Support	N/A
Video Codec	H.264/MPEG4/H.263	H.264/MPEG4/H.263
Voice Codec	G.711	G.711
Signaling	H.323/SIP	H.323/SIP
MIC & Speaker Phone	Support	Support
LAN Port	1	1
PoE(Optional)	Support	Support

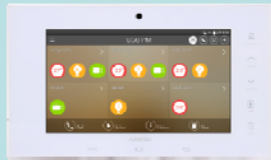
# Smart IP Wall PAD Comparison Table

Model	AP-VWP100	AP-VWP90	AP-VWP80	AP-VWP50
Service Features				
Duplex (Voice)	Full Duplex	Full Duplex	Full Duplex	Full Duplex
LCD	7 Inch	7 Inch	7 Inch	5 Inch
Touch Screen	Support	Support	Support	Support
Camera(Optional)	SD(VGA)	SD(VGA)	SD(VGA)	SD(VGA)
Video Codec	SD, H.264/MPEG4/H.263	SD, H.264/MPEG4/H.263	SD, H.264/MPEG4/H.263	SD, H.264/MPEG4/H.263
Voice Codec	G.722, G.711, G.726	G.722, G.711, G.726	G.722, G.711, G.726	G.722, G.711, G.726
Signaling	H.323/SIP	H.323/SIP	H.323/SIP	H.323/SIP
MIC & Speaker Phone	Support	Support	Support	Support
LAN Port	1	1	1	1
Camera(Optional)	SD(VGA)	SD(VGA)	SD(VGA)	SD(VGA)
Analog Door Phone Interface (option)	SD	SD	SD	SD
PSTN Line (Option)	Support	Support	Support	Support
PoE(Optional)	Support	Support	Support	Support



# Thank you!

**AddPac Technology Co., Ltd.**  
Sales and Marketing

Phone +82.2.568.3848 (KOREA)

FAX +82.2.568.3847 (KOREA)

E-mail : [sales@addpac.com](mailto:sales@addpac.com)