



AP-SAH50

Smart Hub for Legacy Wired Sensors

High Performance Smart Home Solution for Legacy Wired Sensors



AddPac

AddPac Technology

Sales and Marketing

www.addpac.com

Contents

- Product Overview
- Hardware Specification
- APOS Technology
- Network Protocols
- Network Management
- Security Management
- Application Service
- Ordering Information

Product Overview

AP-SAH50 Smart Hub for Legacy Wired Sensors

- Advanced Smart Home Solution
- Legacy Wired Sensor Interface Support
- Smart IP Routing Service Features for Sensor Network
- Smart Wall Pad Interworking Service Features
- Smart Hub Interworking Support for Third Party
- High Performance RISC Programmable Architecture
- One 10/100Mbps Fast Ethernet
- PoE Support : Option
- High Performance LAN-to-Wired Legacy Sensor Routing Capability
- Powerful Network Protocols (PPPoE, DHCP, Static Routing, etc)
- Firmware Upgradeable Architecture
- Smart Web based Management
- Light and Compact Design with External Power Supply

Product Highlights

AP-SAH50 Smart Hub for Legacy Wired Sensors

Powerful Smart Hub for Legacy Wired Sensors

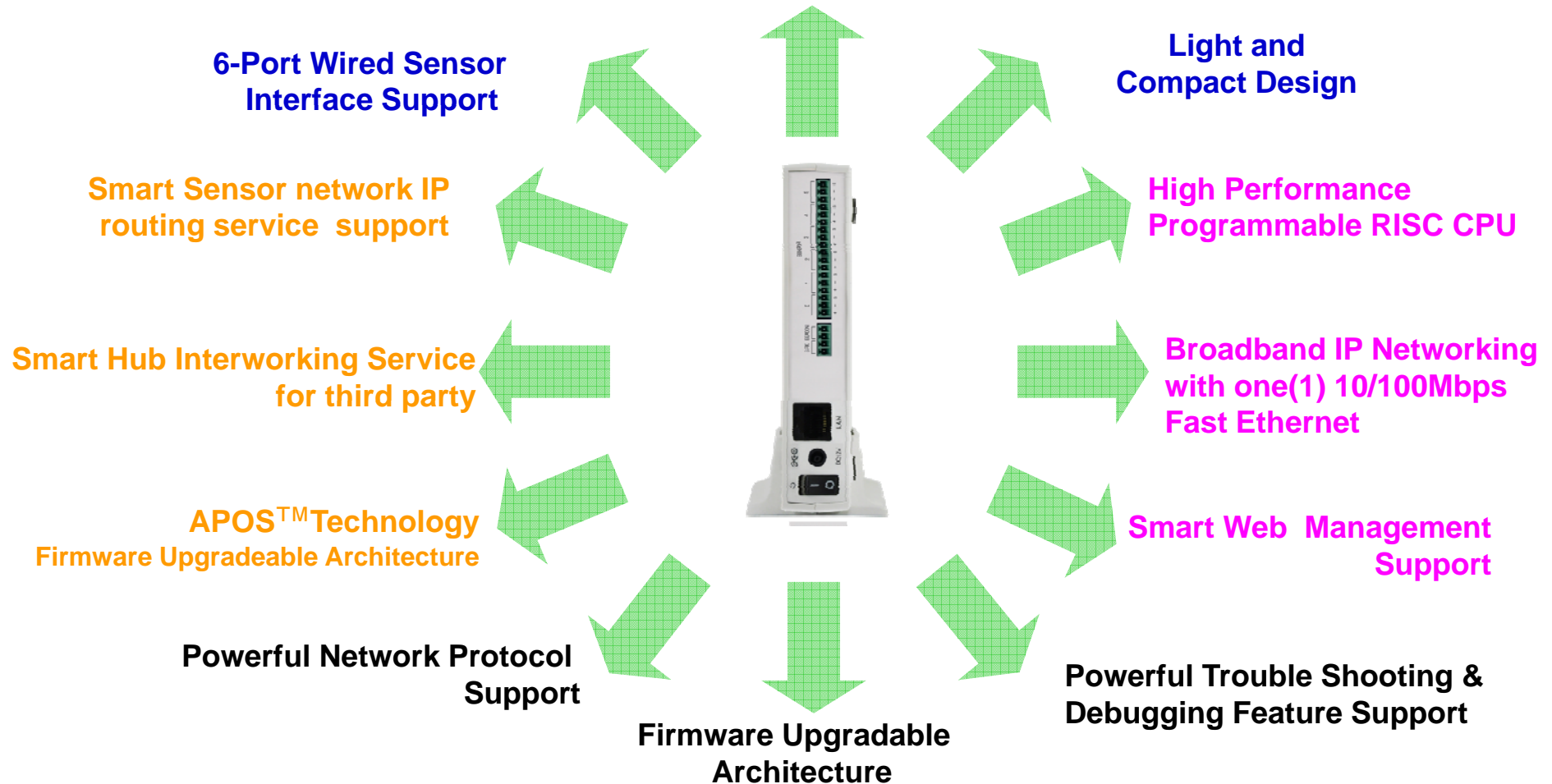

APOS Technology

AP-SAH50 Smart Hub for Legacy Wired Sensors

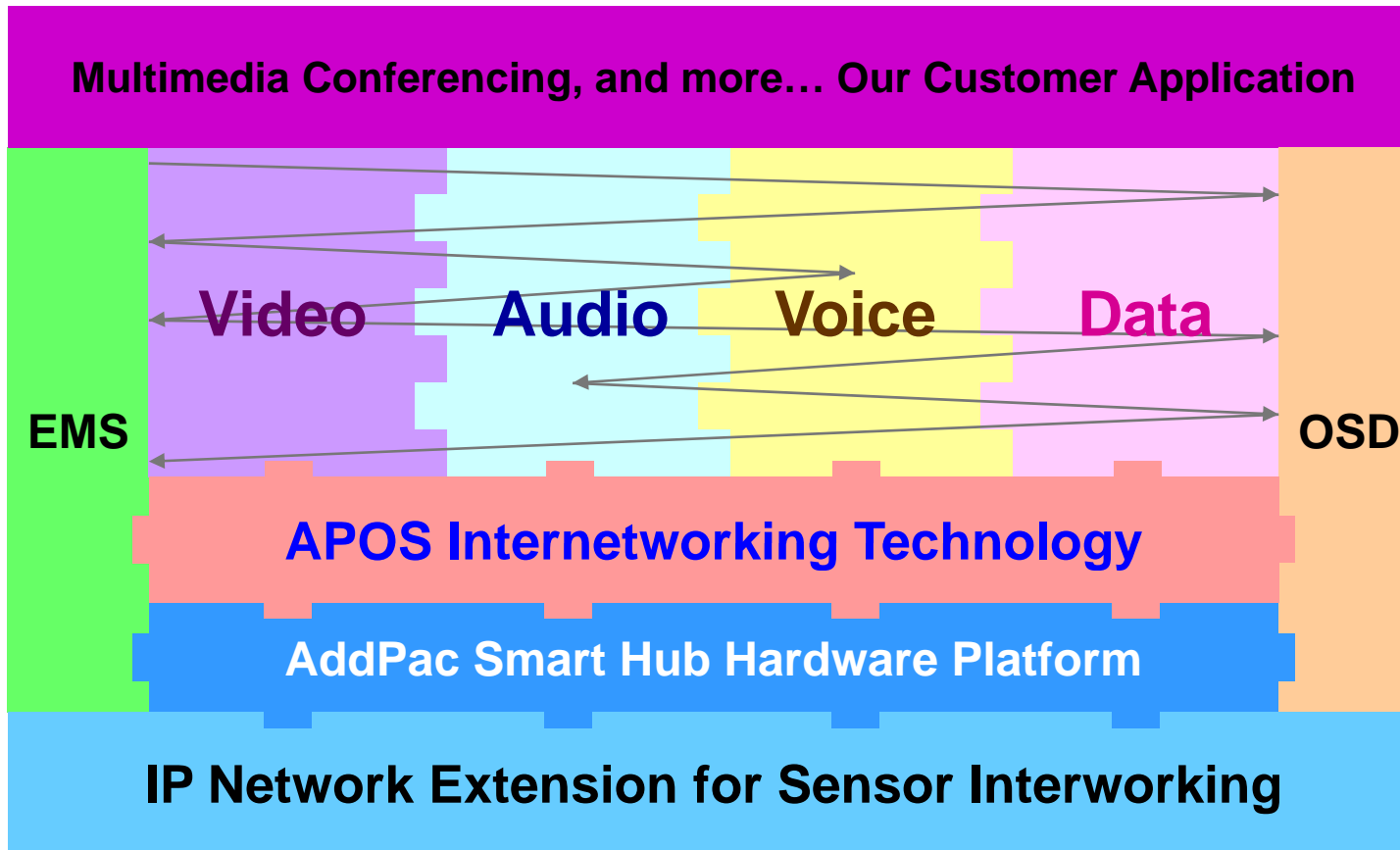

- APOS : AddPac Internetworking Operating System
- OSD : On- Screen Display
- EMS : Element Management System

Hardware Specification

AP-SAH50 Smart Hub for Legacy Wired Sensors

RISC
CPU

- RISC Microprocessor Computing Power
- 6-Port Wired Sensor
 - Alarm Input
 - Power Output for Sensor Power Supply
- Speaker Port, Beacon Port
- Network Interface
 - One(1) 10/100Mbps Fast Ethernet (RJ45)
- LAN LED, Sensor Port LED
- External Power Supply
- PoE (Power over Ethernet) : Option

Hardware Specification

AP-SAH50 Smart Hub for Legacy Wired Sensors



Smart Hub Service Diagram

AP-SH50 Smart Hub Internal H/W Block Diagram

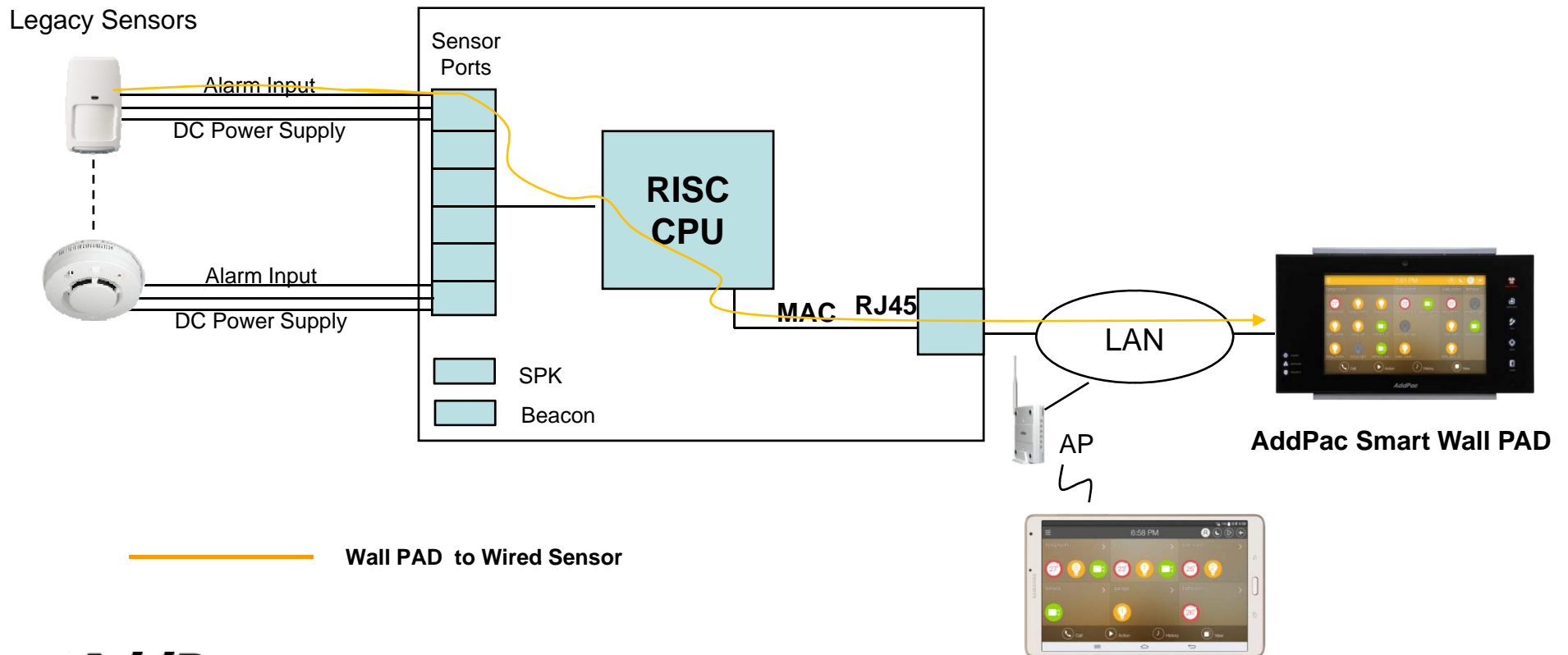

Hardware Specification

AP-SAH50 Smart Hub for Legacy Wired Sensors

AP-SH50 Smart Hub	Basic Specifications
Sensor Interface	Six(6)-Port Wired Sensor Interface (alarm input, dc power supply)
Control Interface	Speaker, Beacon Control Interface
Ethernet Interface	1-Port 10/100Mbps Ethernet Interface(1 x RJ45)
Flash Memory	4Mbyte High-speed Flash Memory
Base Memory	32Mbyte High-speed SDRAM
Power Requirement	Power Supply Adaptor / VAC 110~220V, 50/60Hz, 12V, 2A Optional PoE (Power over Ethernet) Interface
Operating Temperature	0°C ~ 45°C (32 °F ~ 122°F)
Storage Temperature	-40°C ~ 85°C (-40°C ~ 185°F)
Relative Humidity	5% ~ 95% (Non-condensing)
Dimension	142mm x 142mm x 28mm (W x D x H)
Weight (Kg)	0.42Kg

Hardware Specification

AP-SAH50 Smart Hub for Legacy Wired Sensors

Back Side

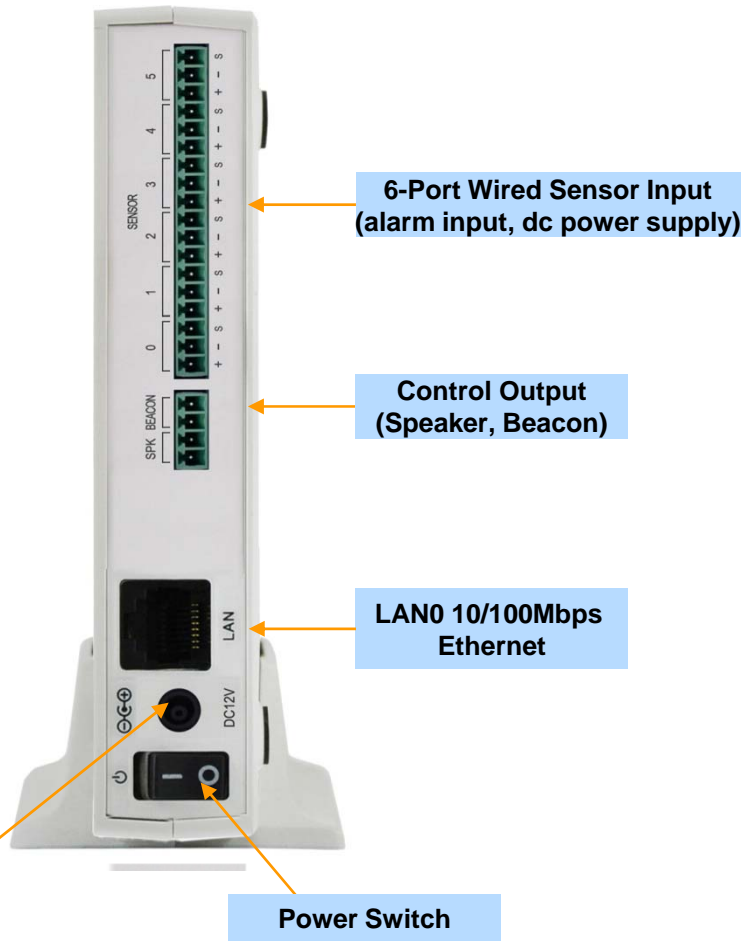

Front Side

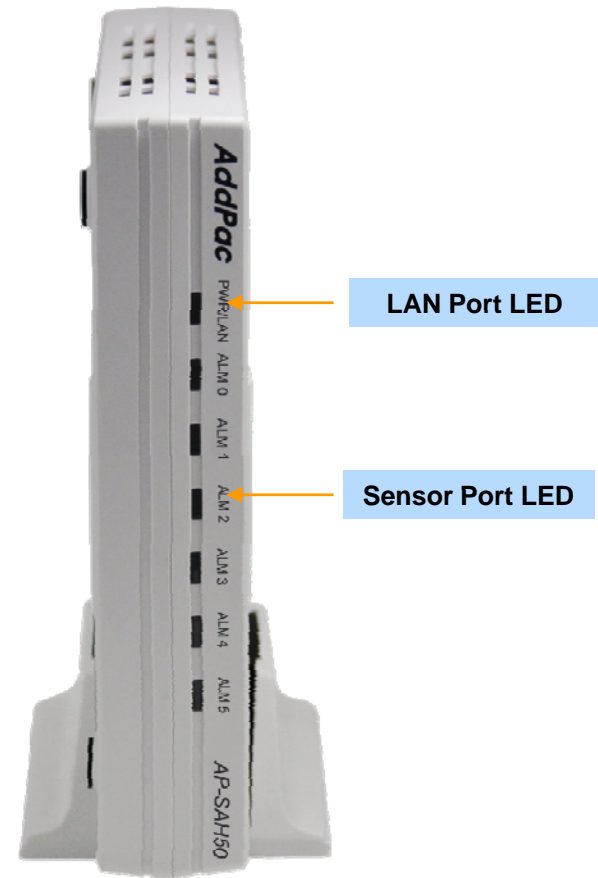

Network Protocols

AP-SAH50 Smart Hub for Legacy Wired Sensors

Basic Network Protocols

- ARP, IPv4, TCP, UDP, ICMP, SCTP, IGMP, MLD

Routing Protocol

- IPv4 : Static

Service Protocol

- FTP, Telnet, TFTP, DHCP Server/Relay, SNMP Server
- CDP (Cisco Discovery Protocol)
- DNS Resolver , DDNS(nsupdate)
- Bridge
- Syslog

IPv4 Address Configuration

- Fixed (Static)
- DHCP
- PPPoE

Miscellaneous

- Cisco Style CLI
- Standard & Extended IPv4 Access List
- Multi-level User Account Management
- IP accounting
- STUN Client

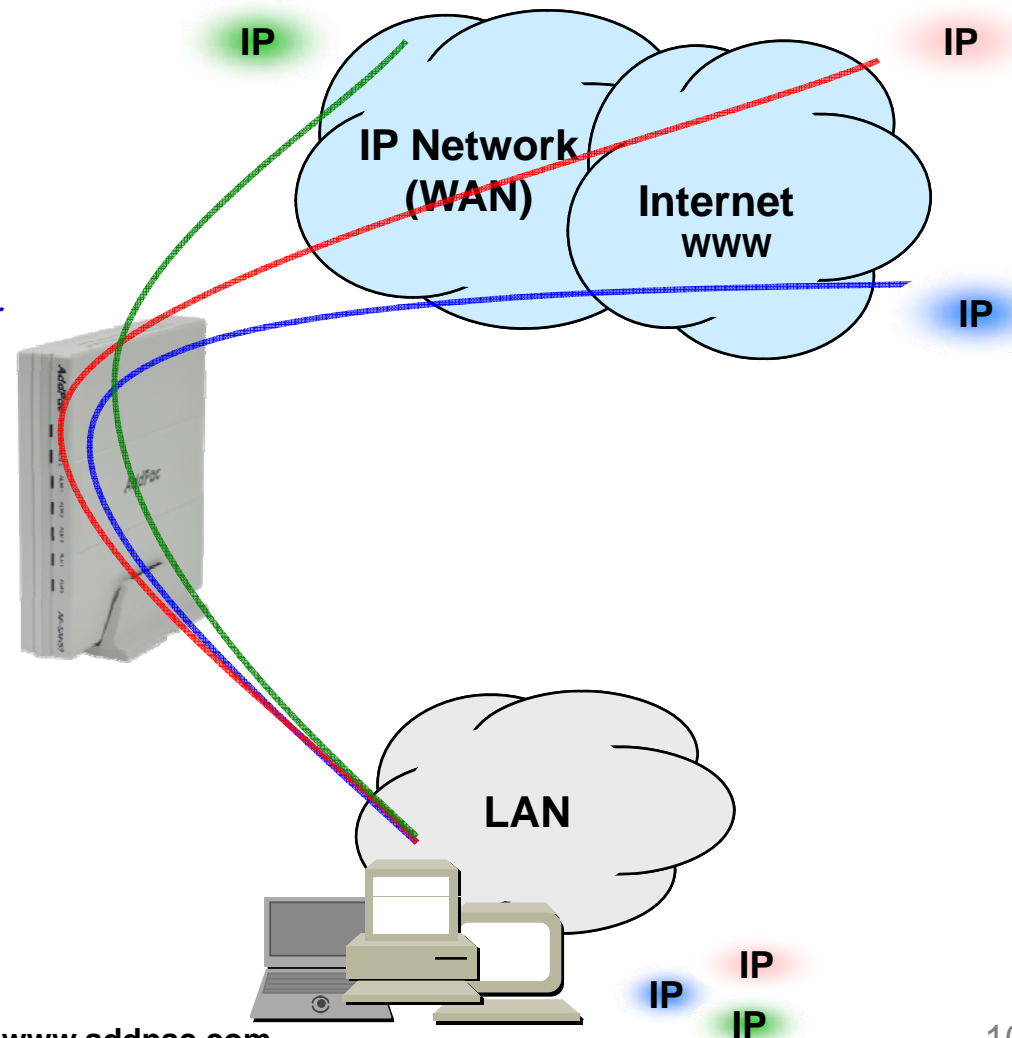

Network Management

AP-SAH50 Smart Hub for Legacy Wired Sensors

- **SNMP**

- Standard Simple Network Management Protocol(SNMP) Agent support
- MIB v1 and v2 Support

- **Web-based Management**

- Smart Easy Setup
- Standard Voice Interface
- Standard PSTN Back-up Interface

- **Watch-dog Function**

- Hardware, Software watch-dog services

- **Remote Management**

- Telnet
- Rlogin

- **Auto Upgrade Service**

- HTTP server based APOS image and configuration file auto-upgrade support

- **Batch Job Function**

- Text based script downloading

- **Interoperable with AP-VPMS Service**

- AddPac VoIP Plug & Play Management System (AP-VPMS)

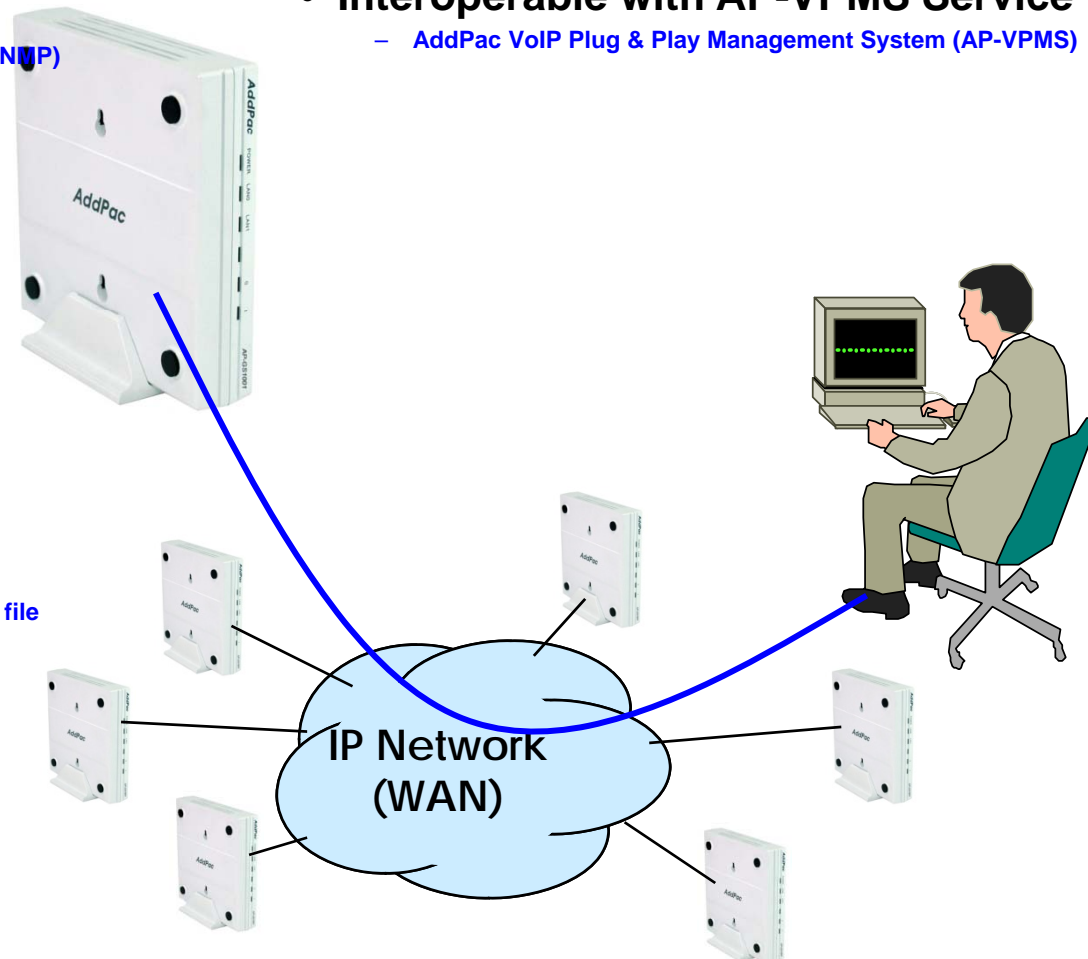

Security Management

AP-SAH50 Smart Hub for Legacy Wired Sensors

- IP packet filtering
- IP access list
- User authentication function
 - Password Authentication Protocol (PAP)
 - Challenge Handshake Authentication Protocol (CHAP)
- Enable/Disable specific protocols
- Auto-square connect of Telnet session
- Account Management function for multi-level user
- SNMP/TELNET/FTP/HTTP/TFTP port assignment function
- SNMP/TELNET/FTP access list management
- Boot mode security checking function

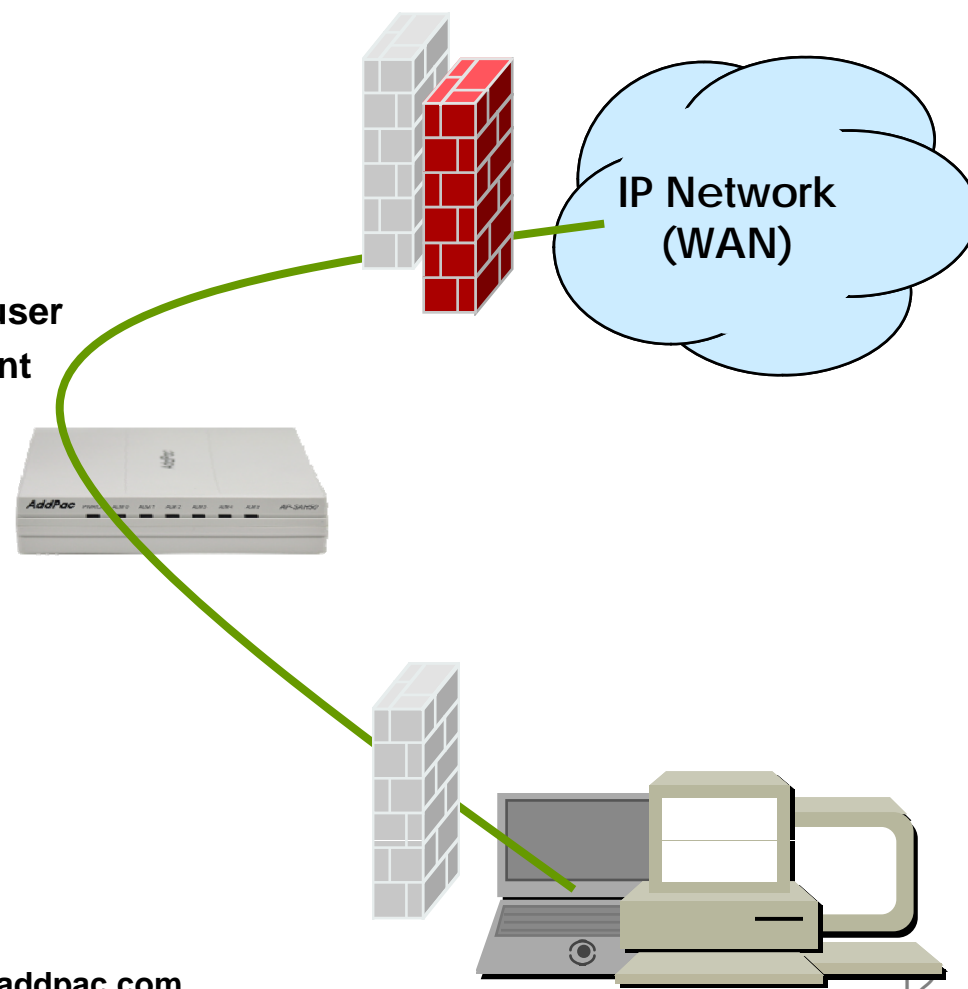

Standard Application

AP-SAH50 Smart Hub for Legacy Wired Sensors

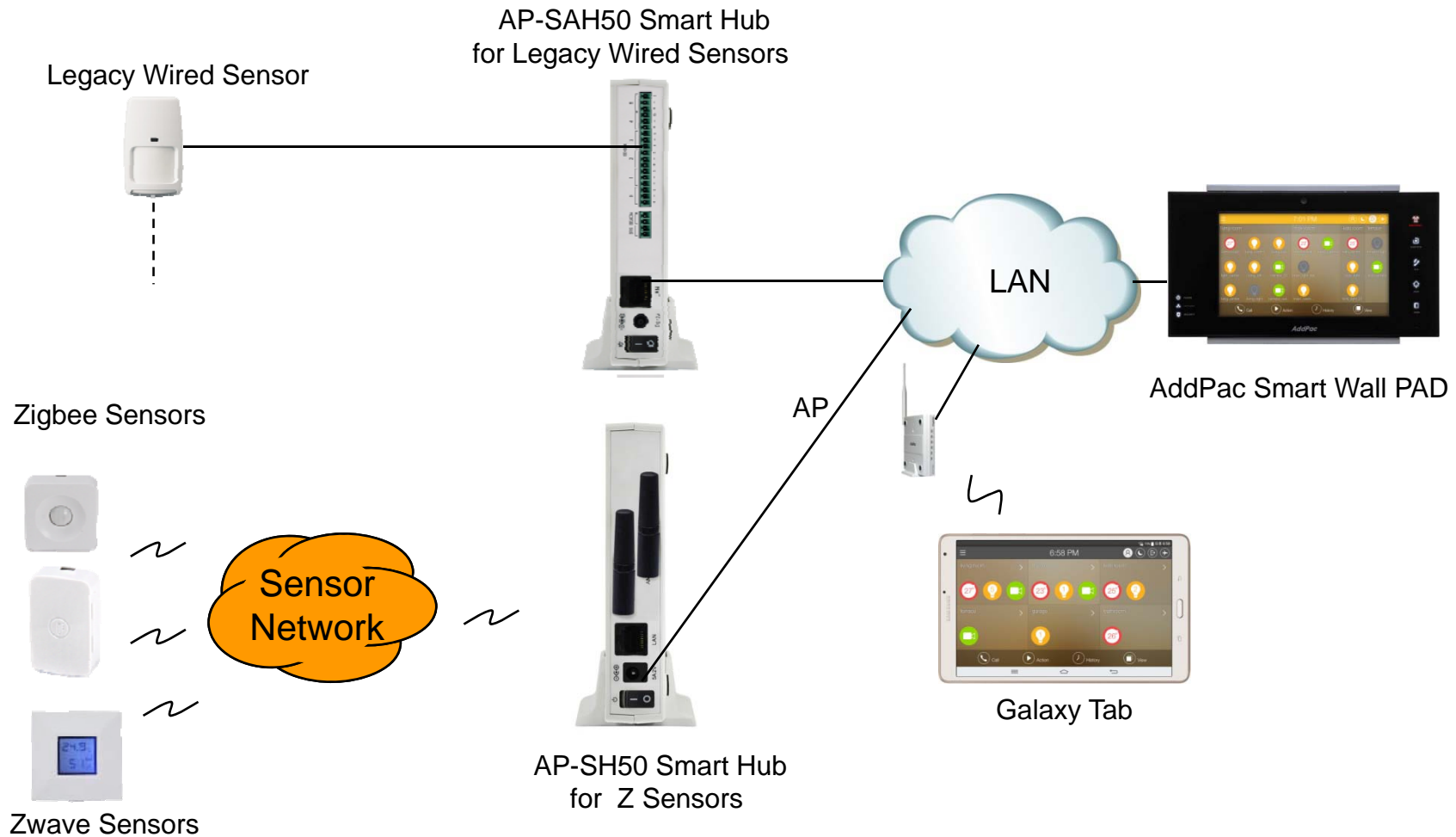

Standard Application

AP-SAH50 Smart Hub for Legacy Wired Sensors

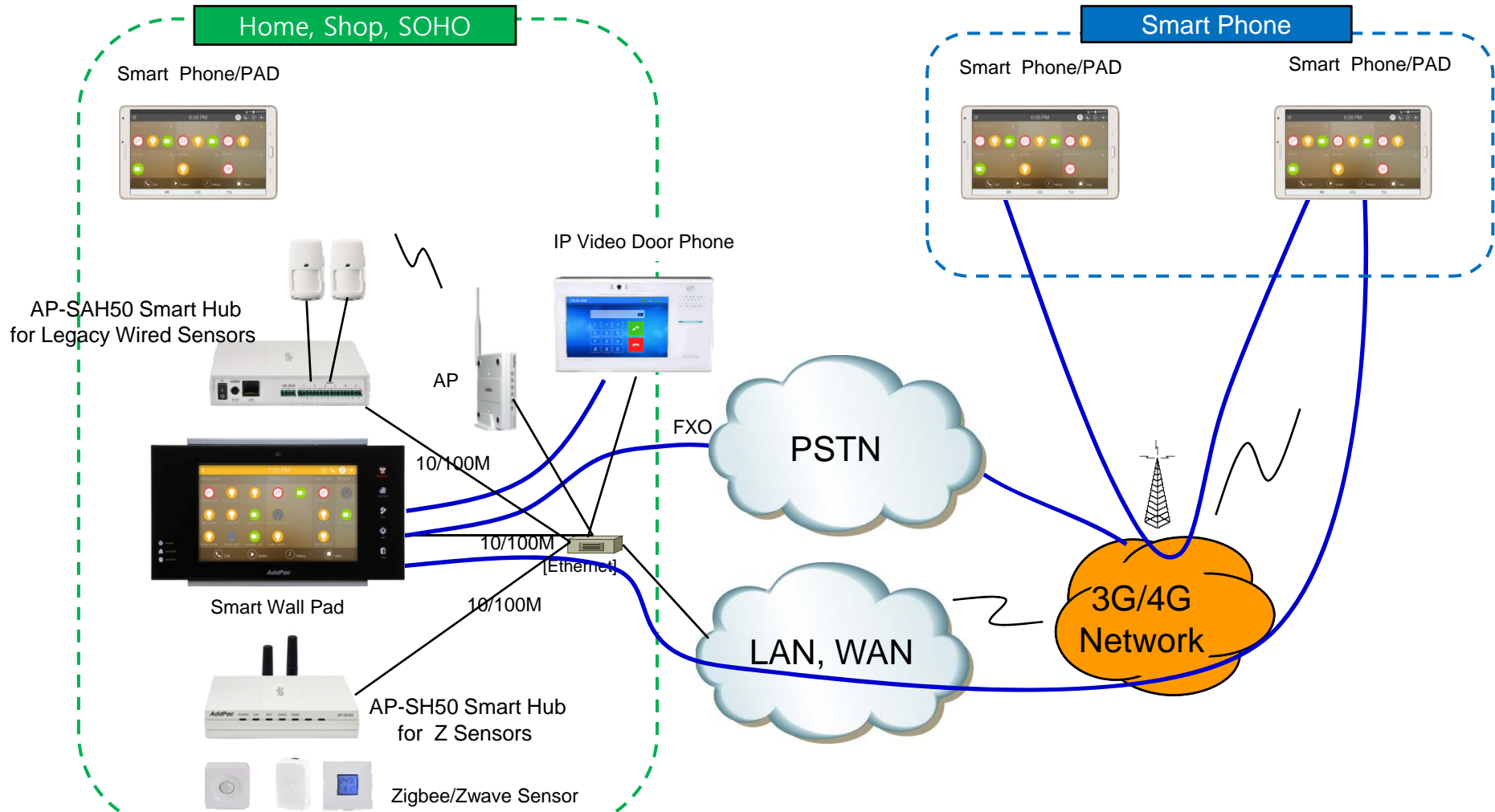

Ordering Information

- **AP-SAH50 Smart Hub for Legacy Wired Sensor**
 - AP-SAH50 Smart Hub Main Body
 - RISC Microprocessor
 - 6-Ports Wired Sensor Interface
 - Speaker, Beacon Control Port
 - 1-port 10/100Mbps Fast Ethernet(RJ45), Option : PoE
 - Including Network Cable, Antenna & Ext. Power Supply, etc.
- **Built-in APOS Internetworking Software for AP-SAH50**
- **Including 1 Year Hardware Warranty**
- **Product Documents**
 - Install and Operation Guide (PDF)
- **Pricing**
 - AddPac Technology Regional Sales Manager
 - Authorized Sales and Marketing Representatives
 - Please Contact www.addpac.com

Smart Hub Series

Thank you!

AddPac Technology Co., Ltd.
Sales and Marketing

Phone +82.2.568.3848 (KOREA)

FAX +82.2.568.3847 (KOREA)

E-mail sales@addpac.com