

Door Access Control System Solution

Door Access Control System Solution

AP-ACS10000 Door Access Control System
AP-ACS1000 Door Access Control System
AP-ACS500 Door Access Control System

Learn More >

AddPac

AddPac Technology

Sales and Marketing

www.addpac.com

Contents

- IP Door Access Control Service Diagram
- IP Video Door Phone Solution
- IP Door Access Control Systems
 - AP-ACS10000 Large Scale System (IP-PBX Separated)
 - AP-ACS1000 (IP-PBX Built-in)
 - AP-ACS500 (IP-PBX Built-in)
- DACS System Message Flow (Examples)
- DACM (Door Access Control Manager)
- TAAM (Time and Attendance Manager)
- Open API for Third Party Controller



Large Scale IP Video Door Phone Service Network Diagram

(Separated Door Access Control and SIP Call Control)

IP-PBX Environment

AP-ACS10000 DACS (Door Access Control System)

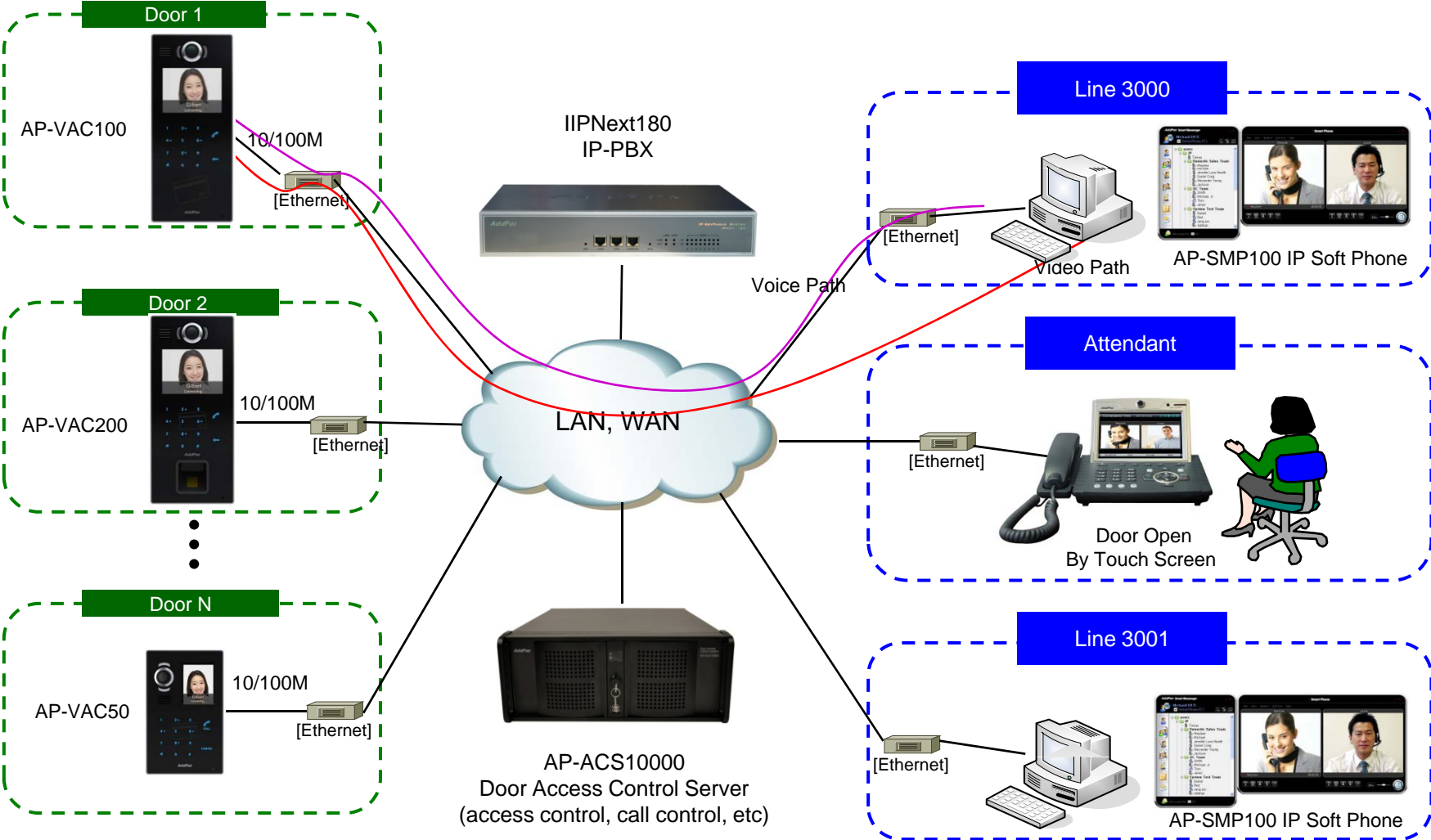

System Redundancy for Fault Tolerant Service

AP-ACS10000 DACS (Door Access Control System)

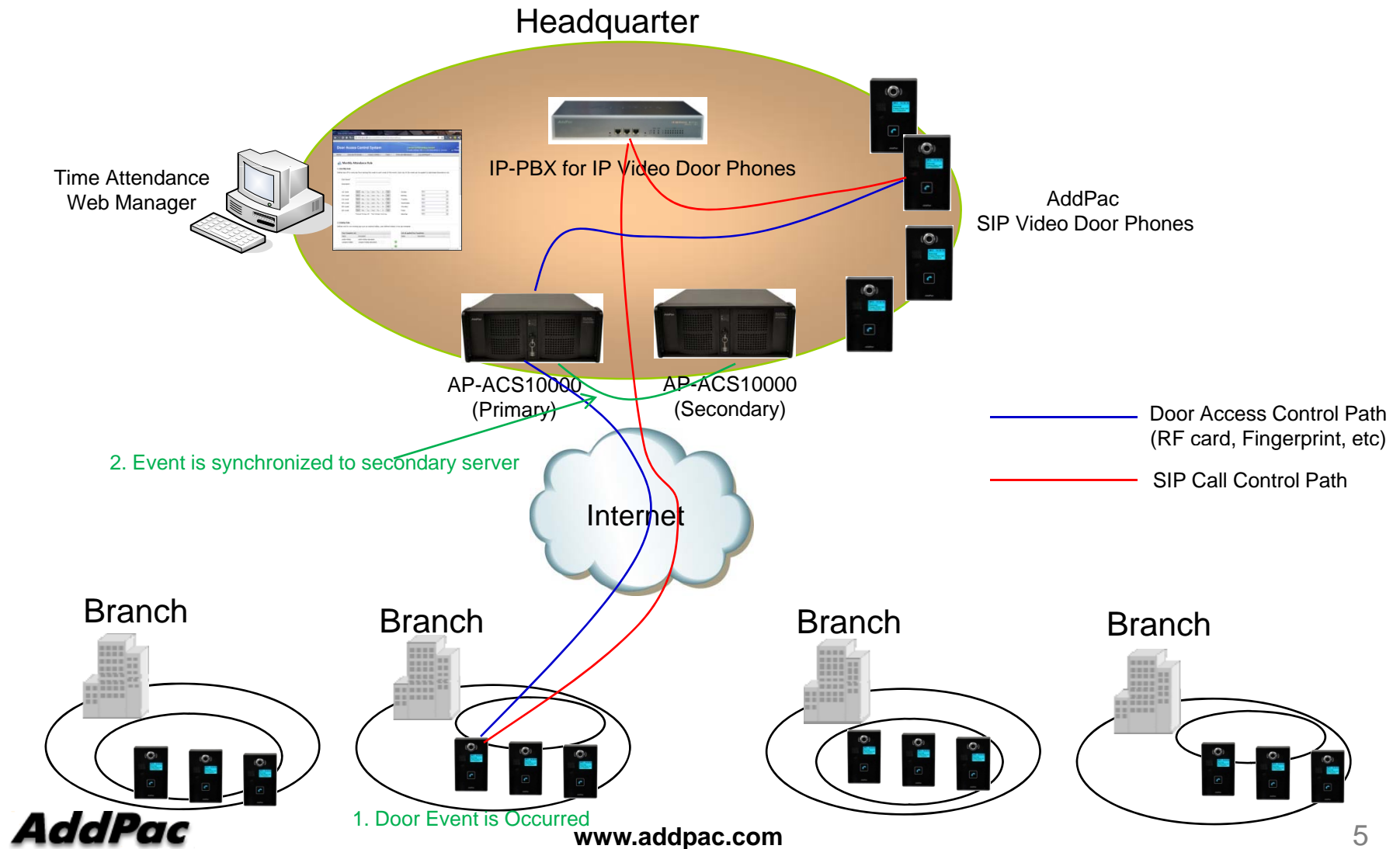



Small & Medium Scale IP Video Door Phone Service Network Diagram

(Integrated Door Access Control and SIP Call Control)

Conventional PBX Environment

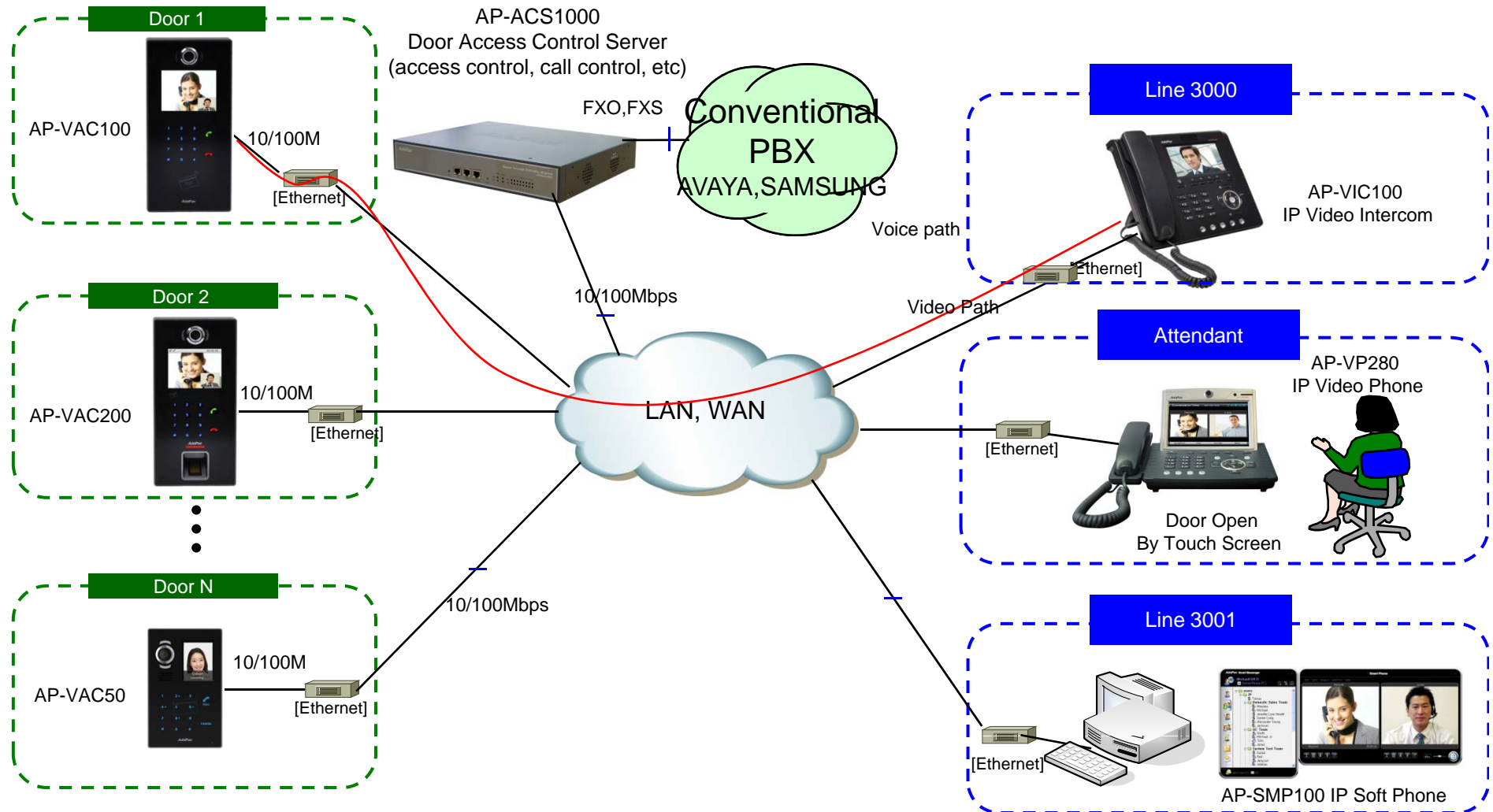

IP-PBX Environment

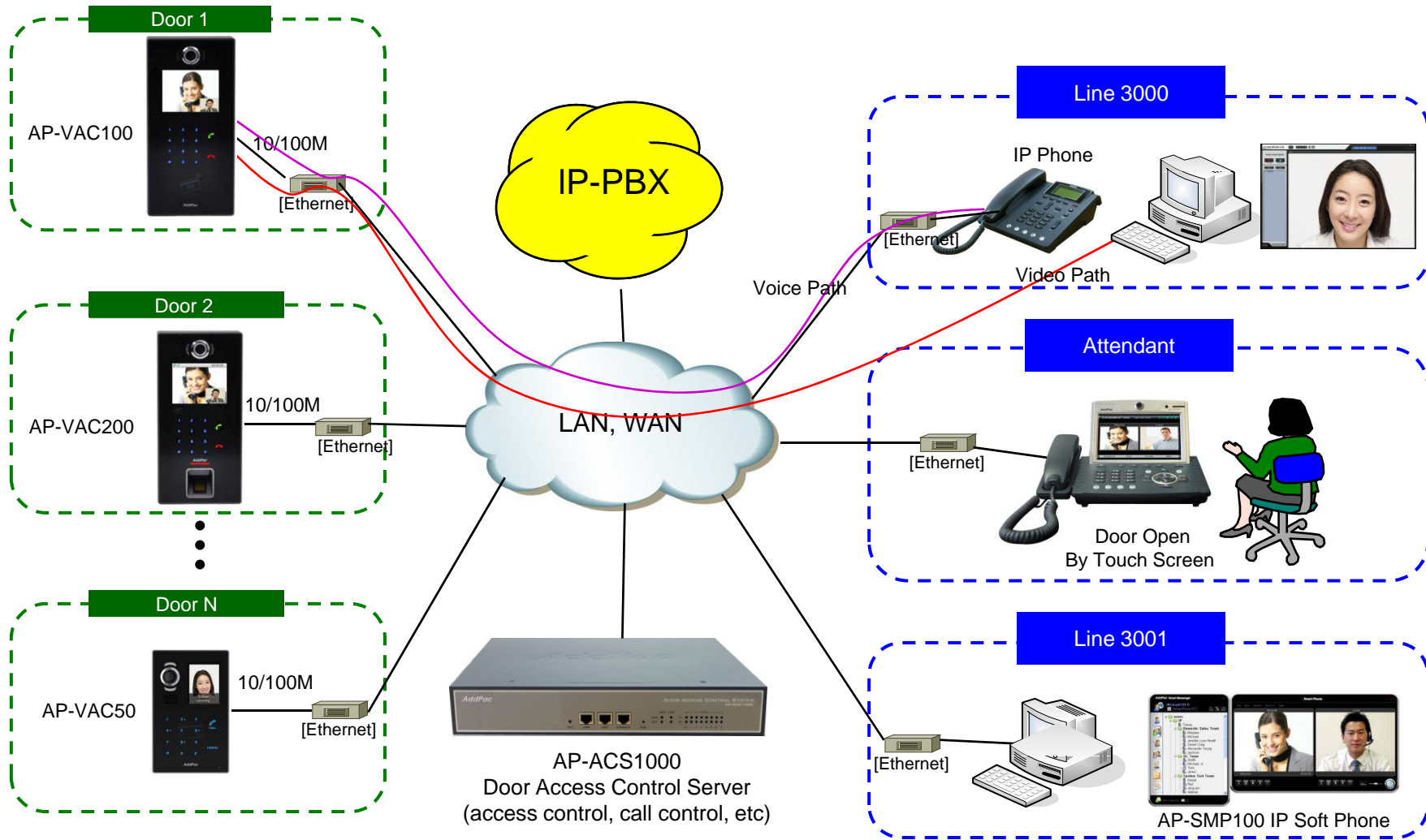



IP Video Door Phones



IP Video Door Phone Comparison Table

| Model | AP-VAC200 | AP-VAC100 | AP-VAC50 | AP-VAC20 |
|---------------------|-----------------------------------------------------------------------------------|-------------------------------------------------------------------------------------|-------------------------------------------------------------------------------------|-------------------------------------------------------------------------------------|
| Service Features |  |  |  |  |
| Duplex (Voice) | Full Duplex | Full Duplex | Full Duplex | Full Duplex |
| Key Pad | 3x4 Key Support | 3x4 Key Support | 3x4 Key Support | 3x4 Key Support |
| LCD | 3.5 Inch | 3.5 Inch | 2inch LCD | Graphic LCD |
| RF Card | Support | Support | Support | Support |
| Fingerprint | Support | N/A | N/A | N/A |
| Camera Sensor | SD(VGA) | SD(VGA) | SD(VGA) | SD(VGA) |
| Video Codec | SD, H.264/MPEG4 | SD, H.264/MPEG4 | SD, H.264/MPEG4 | SD, H.264/MPEG4 |
| Voice Codec | G.711 | G.711 | G.711 | G.711 |
| Signaling | H.323/SIP | H.323/SIP | H.323/SIP | H.323/SIP |
| MIC & Speaker Phone | Support | Support | Support | Support |
| LAN Port | 1 | 1 | 1 | 1 |
| PoE(Optional) | Support | Support | Support | Support |



IP Door Access Control Systems

Door Access Control Server Comparison Table

| Model | AP-ACS10000 | AP-ACS1000 | AP-ACS500 |
|---------------------------------------------------------|------------------------------------------------------------------------------------|-------------------------------------------------------------------------------------|-------------------------------------------------------------------------------------|
| Service Features |  |  |  |
| Registration User Number | N/A | 100 | 30 |
| Concurrent Call User Number | N/A | 30 | 15 |
| VoIP Signaling | Internal | N/A | SIP |
| | External | N/A | H.323/SIP |
| Powerful IVR, UMS, Media Service, User Presence Service | N/A | Support | Support |
| RTP Proxy Service (IPv6, Private IP) | N/A | Support | Support |
| LAN Port | 1 | 2 | 2 |
| VoIP Module Slots for PSTN | N/A | 2 Slots (8 Port Module) | N/A |
| VoIP Interface | N/A | FXS,FXO,E1/T1 | Option |
| Video Door Phone Control (RF card, etc) | Support | Support | Support |
| Time & Attendance Management | Support | Support(option) | Support (Option) |

Contents

- DACS(Door Access Control Server) Network Diagram
 - IP-PBX Integrated Service Model
 - IP-PBX Separated Service Model
- AP-ACS10000 Overview
- AP-ACS1000 Overview
- AP-ACS500 Overview

Integrated Door Access Control and Call Control

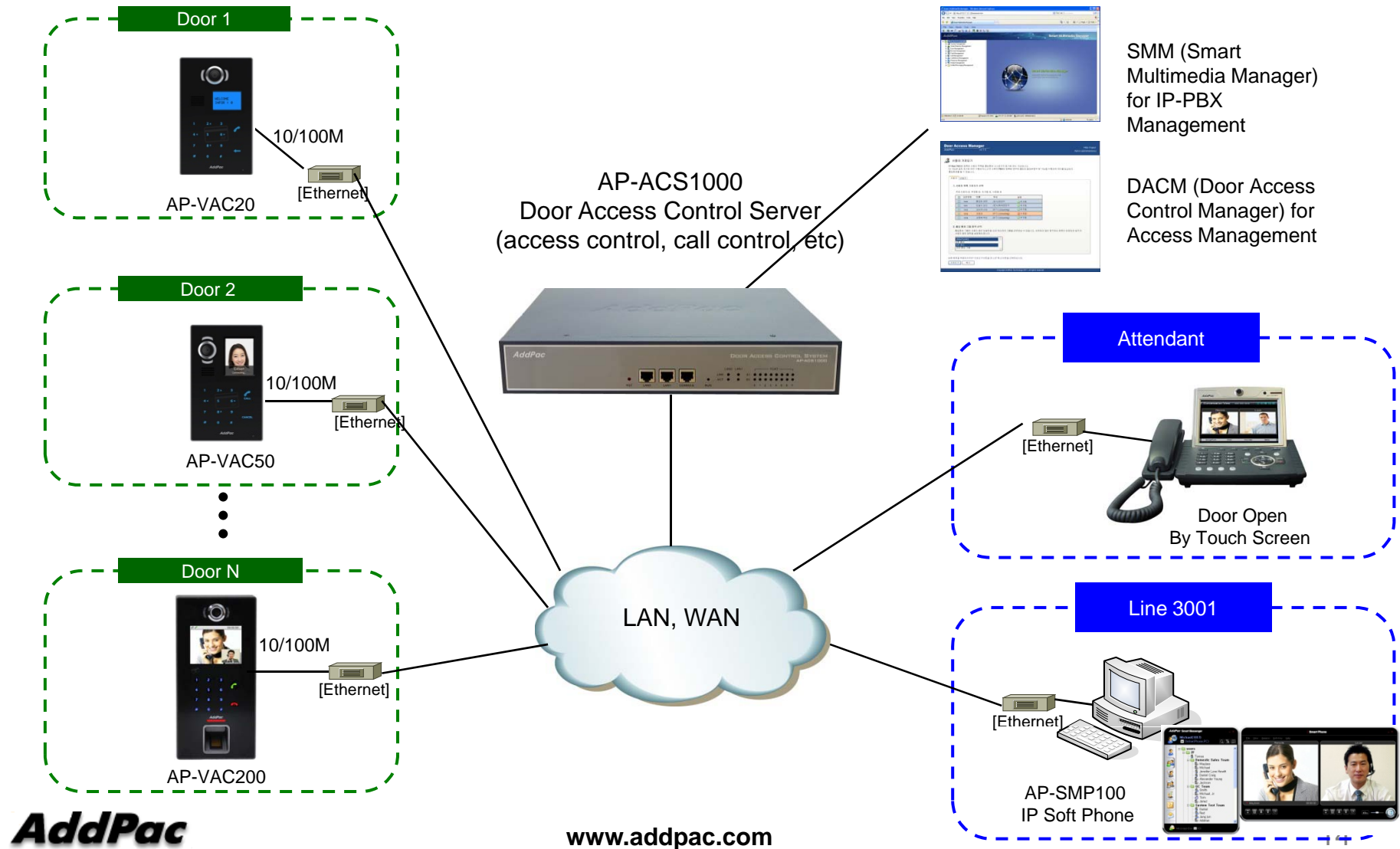

Separated Door Access Control and Call Control

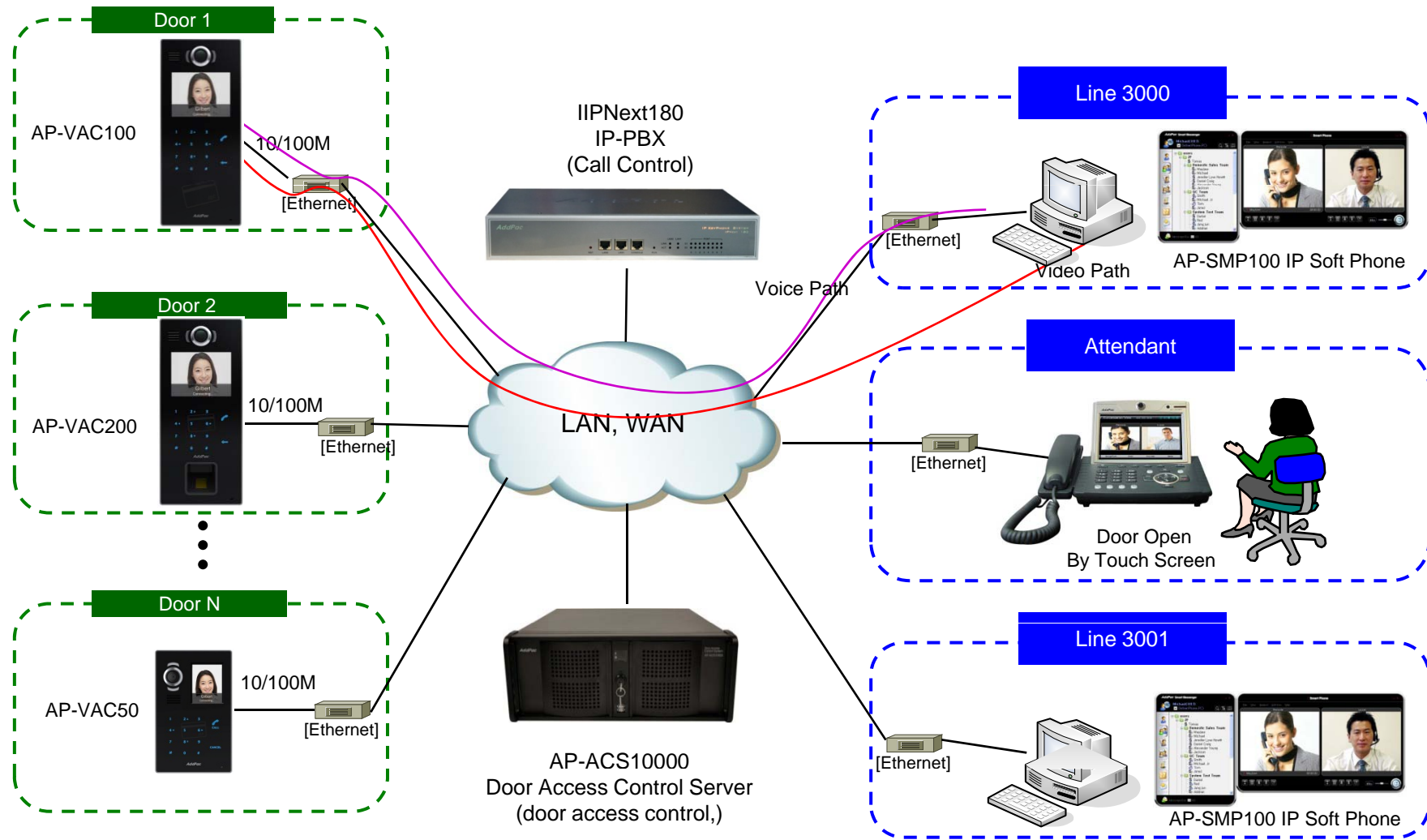



AP-ACS10000 Door Access Control System

Main Features

AP-ACS10000 DACS (Door Access Control System)

- Large Scale Door Access Control Service Features
- Linux Operating System
- Time & Attendance Control System
- Server & Client Architecture
- System Duplication Support for Fault Tolerant Service
- RF Card, Fingerprint Video Door Phone Interworking Service
- Smart Time & Attendance Manager Support (Web based)
- Excel File Import Function for Large User Registration
- Powerful Management and User Friendly Features
- Open API Support for Third Party
- Firmware Upgradeable Architecture
- Up to 4 x 3.5Inch Hard Disk (SATA Type, 2Tera Byte Support)
- One(1) 10/100/1000Mbps Gigabit Ethernet Interface
- USB Interface Support (Front Side, Back Side)

Hardware Specification

AP-ACS10000 DACS (Door Access Control System)

High End
Processor

- High Performance Computing Power
- Main Chassis
 - Network Interface
 - One(1) 10/100/1000Mbps Fast Ethernet
 - Video Output Interface
 - HDMI, DVI, RGB Video Output
 - USB 2.0 Interfaces for Mouse, Keyboard, etc
 - One(1) DVD Writer for Video File Backup
 - Up to Four(4) Hard Disk

Hardware Specification

AP-ACS10000 DACS (Door Access Control System)

High End Processor

Front Side

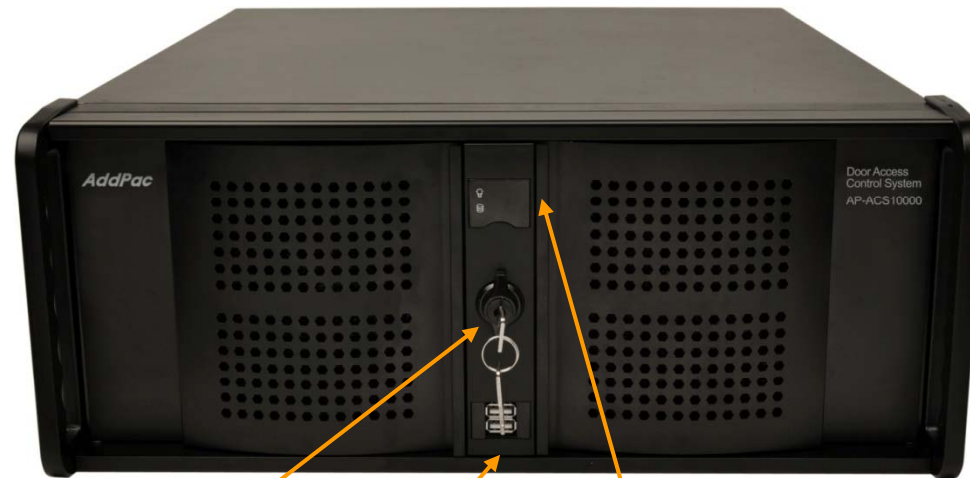

Cabinet Open Key

USB Interface

Power & HDD Access Indication LAMP

Hardware Specification

AP-ACS10000 DACS (Door Access Control System)

High End
Processor

Front Side

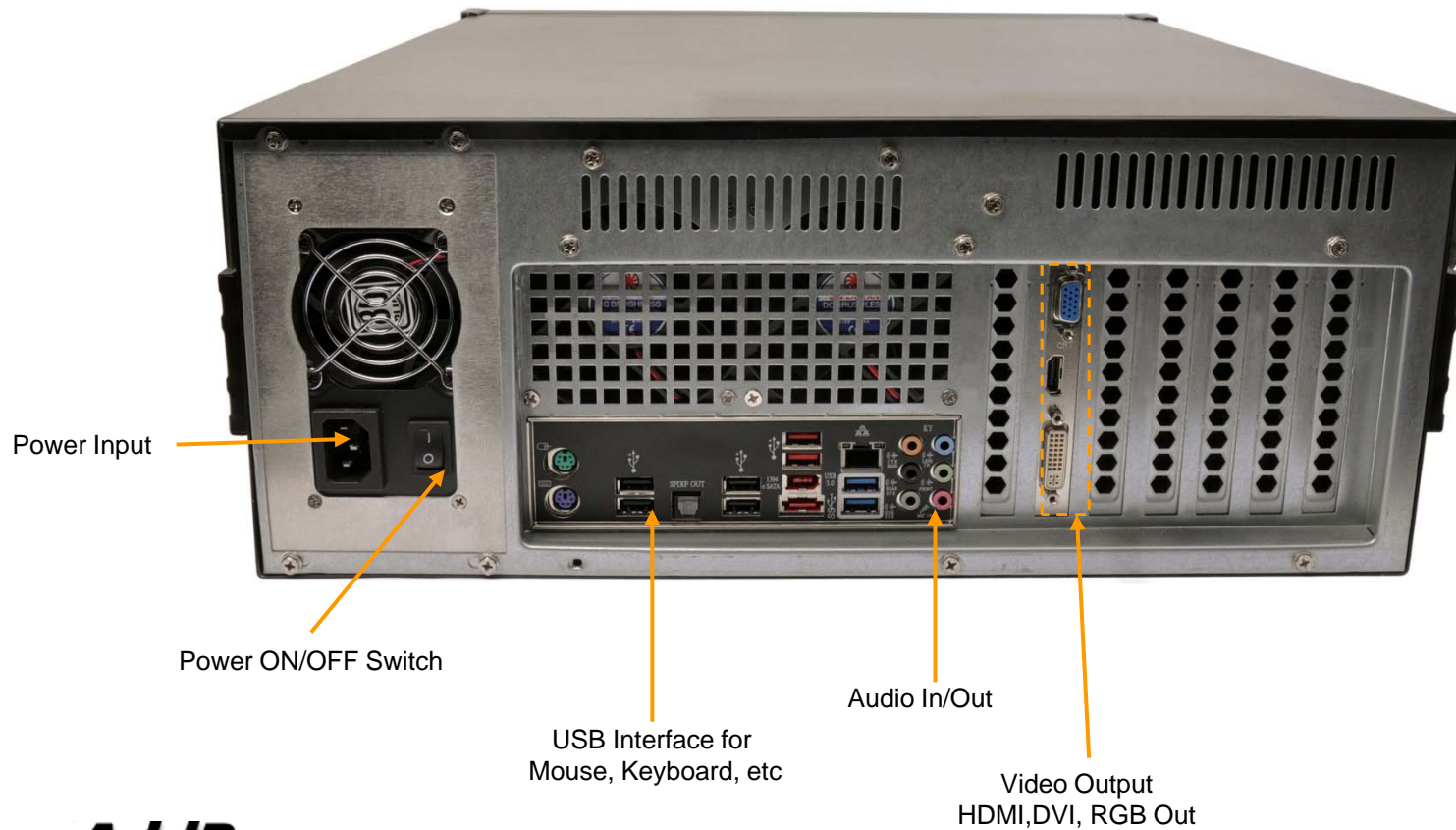



AP-ACS1000 Door Access Control System

Main Features

AP-ACS1000 DACS (Door Access Control System)

- Door Access Control Application System
- SIP Application Server, Proxy, Registrar and Location Server
- Multiple ITSP Trunk with SIP & H.323 Accounts Support
- Legacy PBX Interworking Service
- High Performance RISC & Programmable DSP Architecture
- Two(2) 10/100Mbps Fast Ethernet (IP Share ,etc)
- High Performance LAN-to-LAN Routing Capability
- Powerful Network Protocols (PPPoE, DHCP, Static Routing, etc)
- IPv4/IPv6 Dual Stack
- Firmware Upgradeable Architecture
- Smart Multimedia Manager for IP-PBX Management
- DACM(Door Access Control Manager)
- Advanced Voice QoS Mechanism
- Small, Light and Compact Design
- Two(2) VoIP Module Slots for Analog, Digital Interface

Main Features

AP-ACS1000 DACS (Door Access Control System)

- RISC Microprocessor Computing Power
- Main Chassis
 - Network Interface
 - Two(2) 10/100Mbps Fast Ethernet
 - One(1) RS-232C Console (RJ45)
 - Two(2) VoIP Module Slots for FXS, FXO etc



Hardware Specification

AP-ACS1000 DACS (Door Access Control System)

AP-ACS1000 Back Side



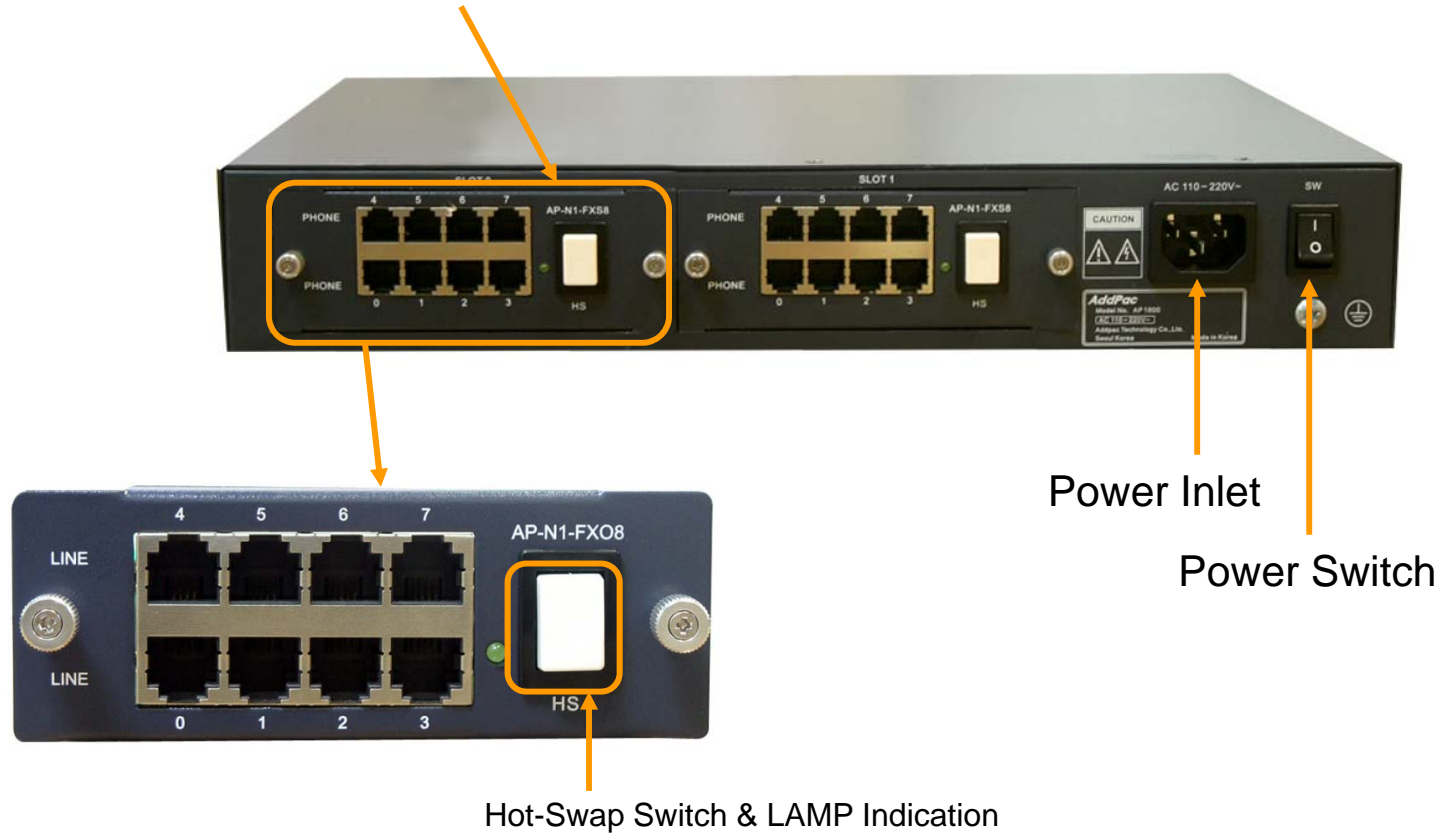

PSTN Interface Module



Hardware Specification

AP-ACS1000 DACS (Door Access Control System)

PSTN Interface Module

| | | |
|---------------------|---------------------------------------------------------------------------------------------------------------------------------------------------------------------------------------------------------|-----------------------------------------------------------------|
| AP-N1-FXS8 |  A black 8-port FXS voice processing module with RJ11 ports numbered 0-7 and a central switch labeled 'HS'. | 8-Port FXS Voice Processing Module (8 x RJ11) |
| AP-N1-FXO8 |  A black 8-port FXO voice processing module with RJ11 ports numbered 0-7 and a central switch labeled 'HS'. | 8-Port FXO Voice Processing Module (8 x RJ11) |
| AP-N1-FXO4S4 |  A black 8-port voice processing module with 4 FXO and 4 FXS ports, numbered 0-7, and a central switch labeled 'HS'. | 4-Port FXO and 4-Port FXS Voice Processing Module (8 x RJ11) |
| AP-N1-E1T1 |  A black 1-port VoIP digital E1/T1 interface module with an RJ45 port and a central switch labeled 'HS'. | 1-Port VoIP Digital E1/T1 Interface Module(1xRJ45) |



AP-ACS500 Door Access Control System

Main Features

AP-ACS500 DACS (Door Access Control System)

- Door Access Control Application System
- SIP Application Server, Proxy, Registrar and Location Server
- Multiple ITSP Trunk with SIP & H.323 Accounts Support
- Legacy PBX Interworking Service
- High Performance RISC & Programmable DSP Architecture
- Two(2) 10/100Mbps Fast Ethernet (IP Share ,etc)
- High Performance LAN-to-LAN Routing Capability
- Powerful Network Protocols (PPPoE, DHCP, Static Routing, etc)
- IPv4/IPv6 Dual Stack
- Firmware Upgradeable Architecture
- Smart Multimedia Manager for IP-PBX Management
- DACM(Door Access Control Manager)
- Advanced Voice QoS Mechanism
- Small, Light and Compact Design
- Power Switch for Stability and Status LEDs



Hardware Specification

AP-ACS500 DACS (Door Access Control System)

- RISC Microprocessor Computing Power + High End Programmable DSP
- VoIP Gateway Interface
 - Model A: Basic Configuration
 - Model B: Two(2) FXO Port
 - Model C: Four(4) FXO Port
 - Model D: Two(2) FXS + Two(2) FXO Port
- Network Interface
 - Two(2) 10/100Mbps Fast Ethernet (RJ45)
- USB Interface
 - One(1) USB Host Mode Interface for USB Memory and Wireless LAN
- Power Supply
 - External Power Adaptor
- Power On/Off Switch
- Power LED, LAN LEDs, FXO Port LEDs





DACS System Message Flow

DACS System Message Flow

Registration and KeepAlive

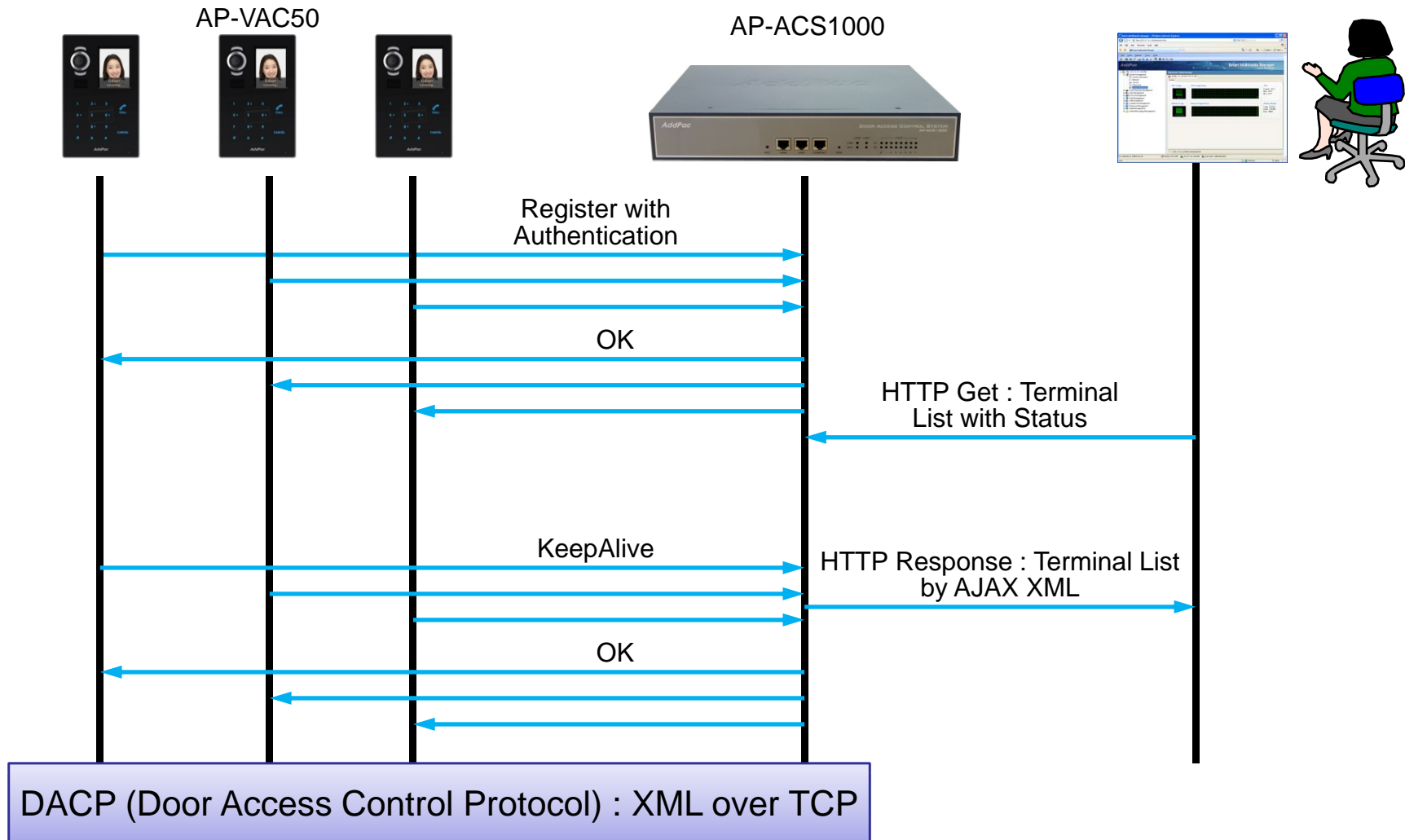

DACS System Message Flow

Access Privilege and Schedule Download

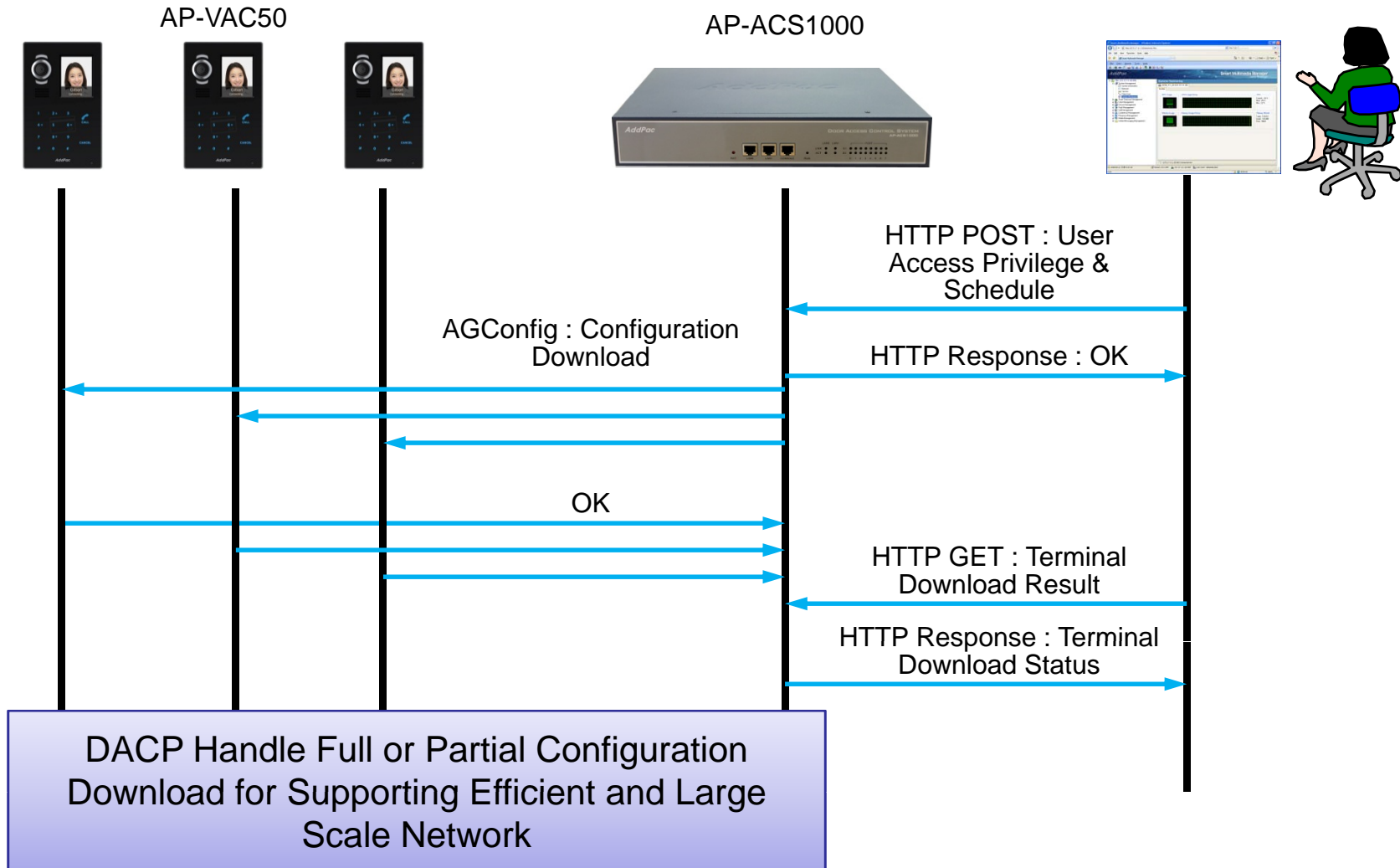

DACS System Message Flow

RF Card Read/Write and Registration

AP-VAC50



AP-ACS1000

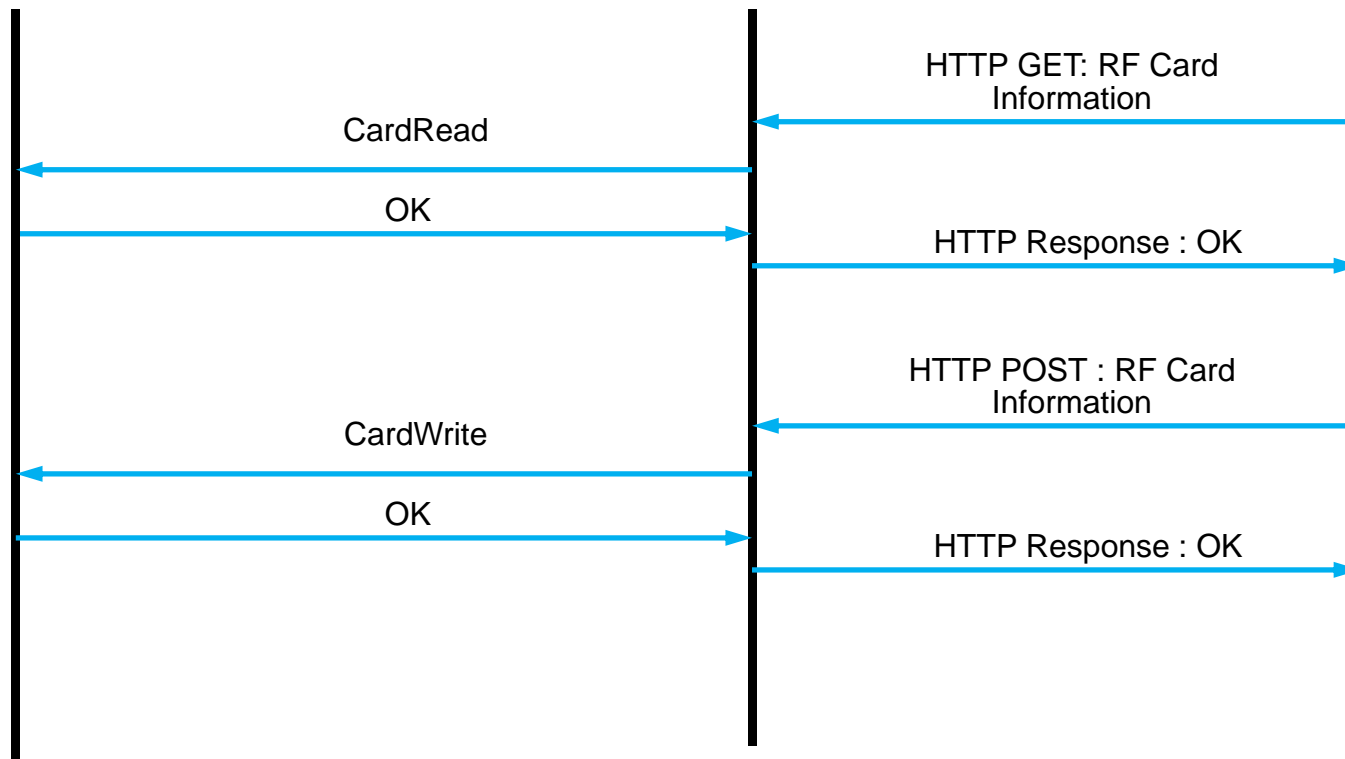
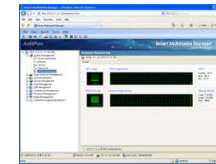

DACS System Message Flow

Door Open by RF Card or Password

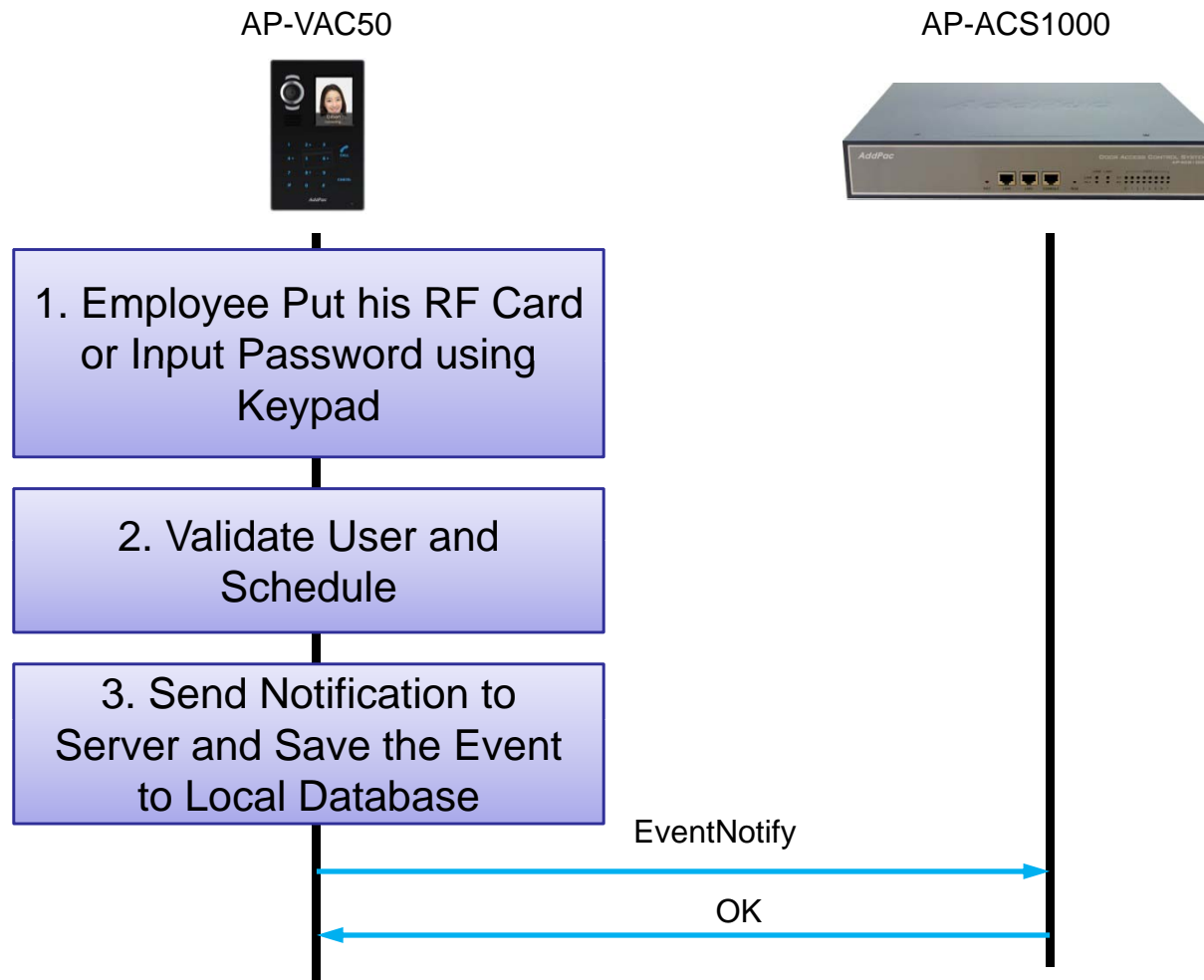

DACS System Message Flow

Door Open by Fingerprint

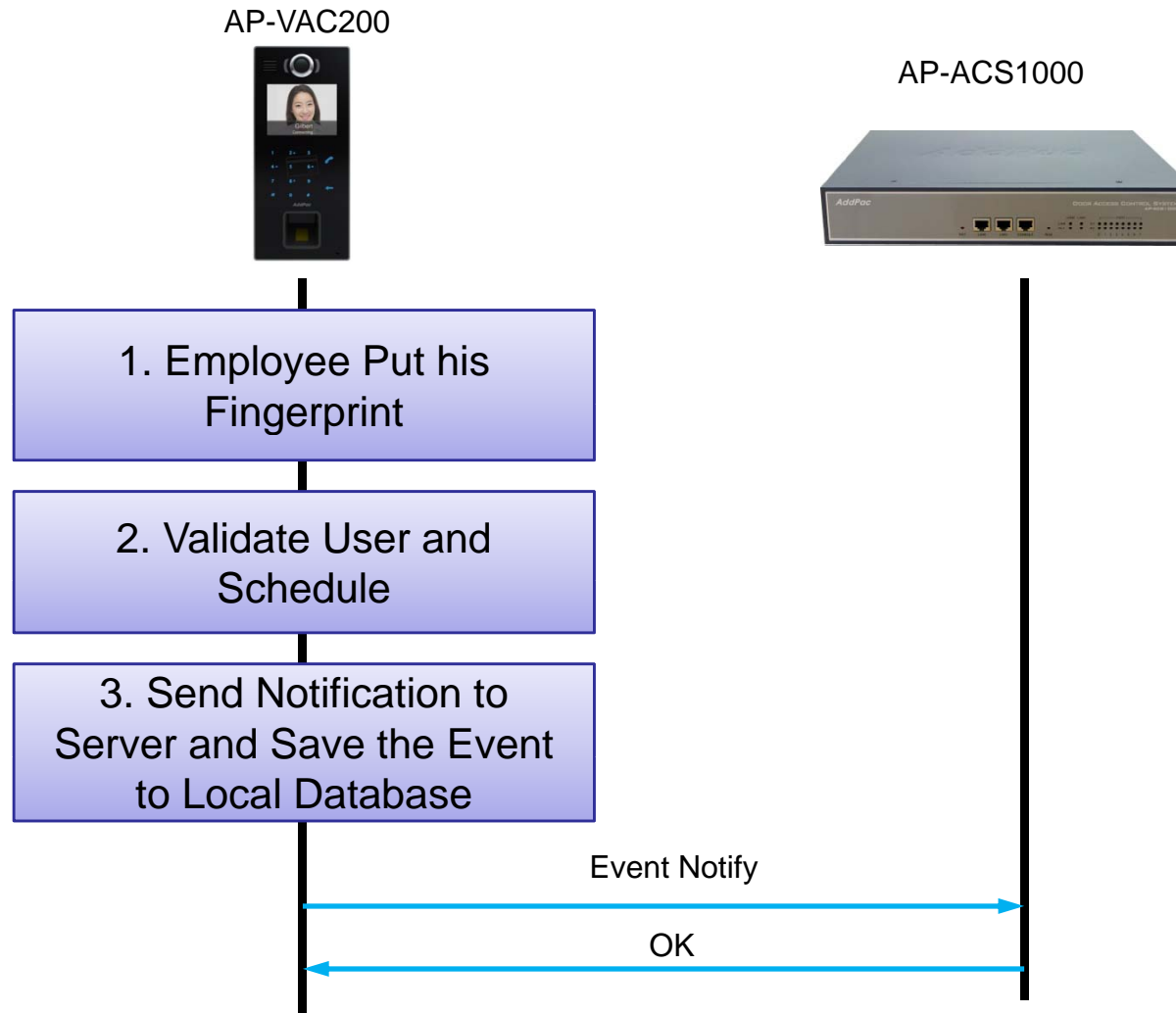

DACS System Message Flow

Door Open by Other Terminal

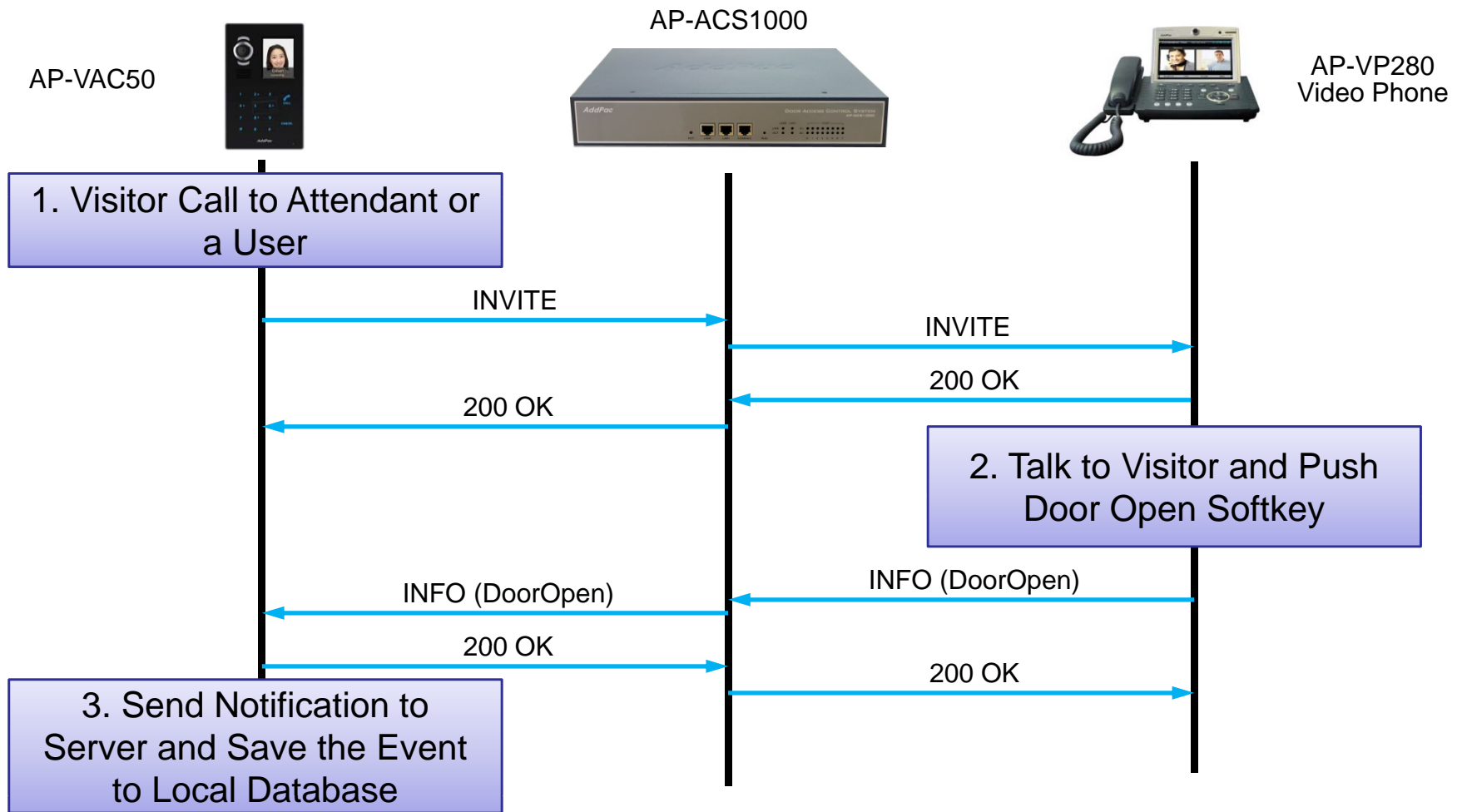

SIP VoIP Message Flow

Door Open by Other Terminal

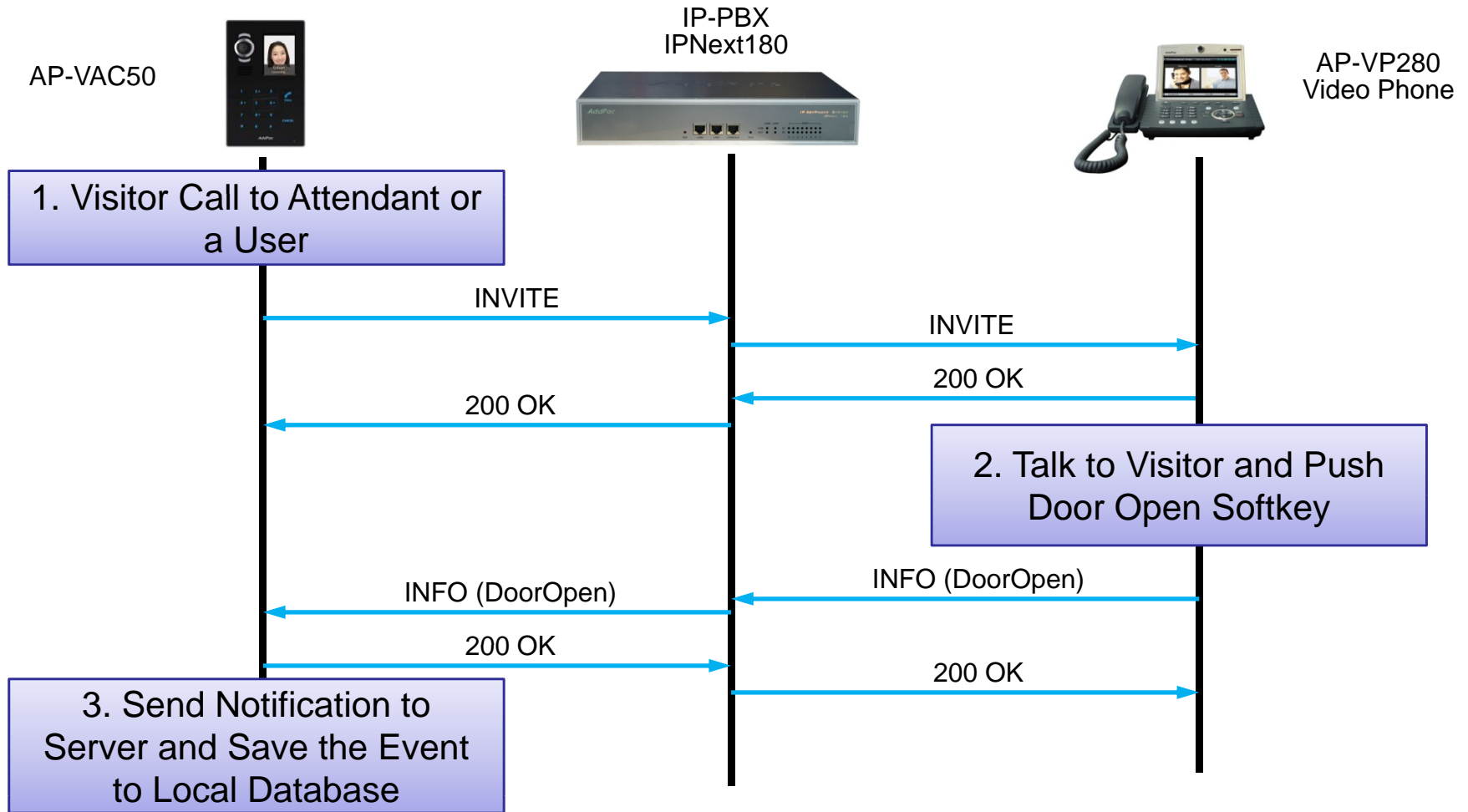



Door Access Control System Web Manager Software (DACM, TAAM)

DACS (Door Access Control System)

Login page

The screenshot shows a web browser window with the URL `172.16.1.19/index.php`. The page title is "Door Access Control System". The main content area features the "AddPac Door Access Control System" logo and a login form with fields for "Administrator ID" (containing "root") and "Password" (masked with dots). Below the form are two buttons: "Door Access Control Manager" and "Time and Attendance Manager".

Annotations on the screenshot include:

- A yellow box at the top center containing the text: "You can log on 'Door Access Control Manager' or 'Time and Attendance Manager' if license is valid and administrator have authentication right". A yellow arrow points from this box to the login form.
- A blue box on the left containing the text: "Log on to Door Access Control Management". A blue arrow points from this box to the "Door Access Control Manager" button.
- A blue box on the right containing the text: "Log on to Time and Attendance Management". A blue arrow points from this box to the "Time and Attendance Manager" button.



Door Access Control Web Manager Software (DACM)

DACM (Door Access Control Manager)

Main Web Page

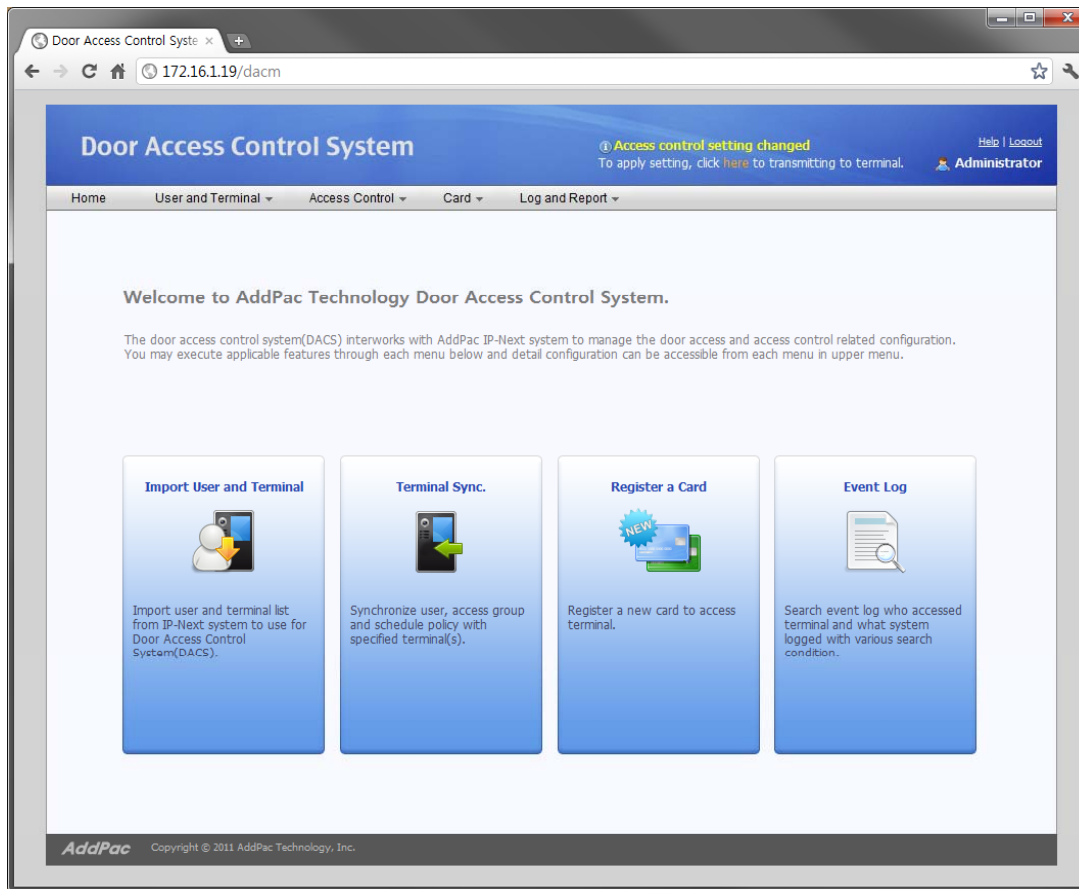

DACM (Door Access Control Manager)

Import User and Terminal

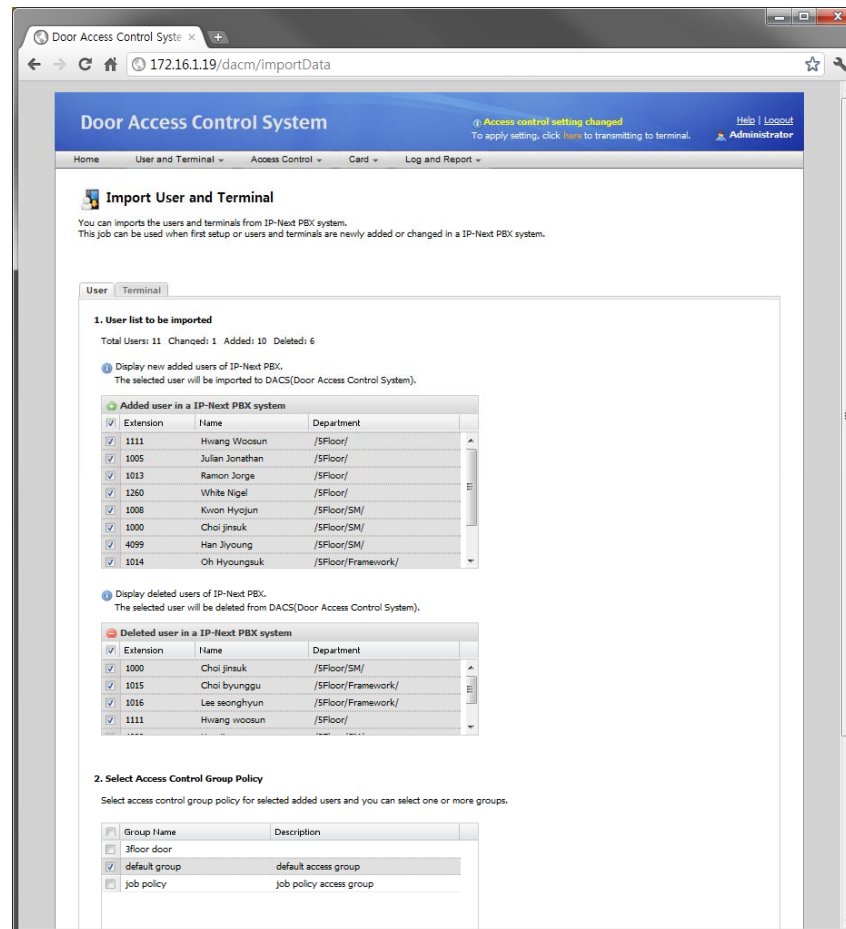

DACM (Door Access Control Manager)

User List

User List

The screenshot shows a web browser window displaying the 'Door Access Control System' user list. The page title is 'Door Access Control System' and the URL is '172.16.1.19/dacm/userList'. A notification at the top right states 'Access control setting changed' with a link to 'To apply setting, click here to transmitting to terminal.' and a 'Logout' button. The navigation menu includes 'Home', 'User and Terminal', 'Access Control', 'Card', and 'Log and Report'. The main content area is titled 'User List' and contains a search bar with a dropdown menu set to 'All Users', an 'Input search word' field, and a 'Search' button. Below the search bar is a table with the following data:

| Extension | Name | Department | Access Policy | Date Created | Modify | Delete |
|-----------|---------------|--------------------|---------------|---------------------|--------|--------|
| 1 1000 | Choi jinsuk | /SFloor/SM/ | Access Allow | 2011-07-22 15:50:01 | | |
| 2 1008 | Kwon hyojun | /SFloor/SM/ | Access Allow | 2011-07-22 15:50:00 | | |
| 3 1014 | Oh hyongsuk | /SFloor/Framework/ | Access Allow | 2011-07-22 15:50:01 | | |
| 4 1015 | Choi byunggu | /SFloor/Framework/ | Access Allow | 2011-07-22 15:50:01 | | |
| 5 1016 | Lee seonghyun | /SFloor/Framework/ | Access Allow | 2011-07-22 15:50:01 | | |

At the bottom of the page, there is a footer with the 'AddPac' logo and the text 'Copyright © 2011 AddPac Technology, Inc.' The page navigation shows 'Page 1 of 1' and 'Total: 5'.

DACM (Door Access Control Manager)

Access Control Group Management

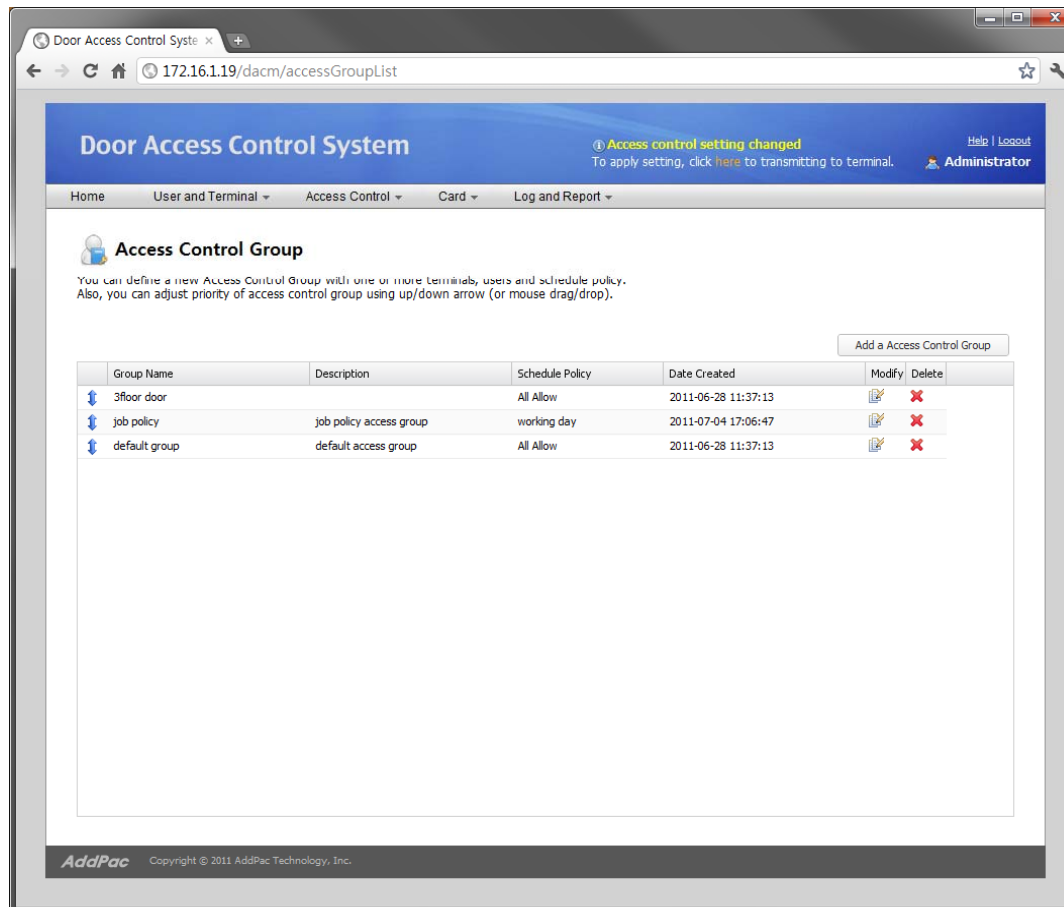

DACM (Door Access Control Manager) Configuration Download to Terminal

Door Access Control System

Access control setting changed
To apply setting, click [here](#) to transmitting to terminal.

Help | Logout
Administrator

Home User and Terminal Access Control Card Log and Report

Terminal Sync.

Synchronize user, access group and schedule policy with selected terminals.
Default checked terminals have updated configurations need to be synchronized.

| <input checked="" type="checkbox"/> | Terminal Name | IP Address | Connection Status | Sync Status |
|-------------------------------------|------------------------|-------------|-------------------|----------------------|
| <input checked="" type="checkbox"/> | 2floor door terminal | 172.16.10.4 | Connected | Not yet synchronized |
| <input checked="" type="checkbox"/> | 3floor door terminal | 172.16.10.1 | Connected | Not yet synchronized |
| <input checked="" type="checkbox"/> | 5floor door terminal | 172.16.10.2 | Connected | Not yet synchronized |
| <input checked="" type="checkbox"/> | The main entrance door | 172.16.10.3 | Connected | Not yet synchronized |

To synchronize with selected terminal above, select 'Sync' button below. Select 'Cancel' button to cancel.

AddPac Copyright © 2011 AddPac Technology, Inc.

DACM (Door Access Control Manager)

RF Card Management

Door Access Control System

Access control setting changed
To apply setting, click [here](#) to transmitting to terminal.

Help | Logout
Administrator

Home User and Terminal Access Control Card Log and Report

Card List

Display registered card list. Also, you can register a new card or modify/delete selected card(s).

Search List: All card

| Serial Number | Extension | Username | Status | Description | Date Created | Modify | Delete |
|---------------|-----------|-------------|-----------------------------------------------|-----------------------------|---------------------|--------|--------|
| 1 4000238 | 1008 | Kwon hyojun | <input checked="" type="checkbox"/> Specified | Temporary cards are issued. | 2011-07-08 15:59:03 | | |
| 2 123456789 | | | <input type="checkbox"/> Unspecified | | 2011-07-22 16:17:04 | | |

Page 1 of 1 Total: 2

AddPac Copyright © 2011 AddPac Technology, Inc.

DACM (Door Access Control Manager)

Fingerprint Management

The screenshot shows the 'Door Access Control Manager' web interface. The browser address bar displays '172.17.216.250/webapps/dacm/updateUser/1007'. The page title is 'Door Access Control Manager'. A notification banner at the top right states: 'Access control setting changed. To apply setting, click here to transmitting to terminal.' The user is logged in as 'root'. The navigation menu includes: Home, User and Terminal, Access Control, Card, and Log and Report.

The main content area is titled 'User Information and Policy' and contains a '1. Profile' section with the following fields:

- Extension Number: 1007 (2~12 digits)
- First Name: [Empty]
- Last Name: 최진석 선임
- Position: [Empty]
- Department: /5F/Smart work/Smart Manage
- E-Mail: jschoi@addpac.com
- Home Phone: [Empty]
- Mobile Phone: 01026339101
- Card Serial Number: 32480D32 (with a 'Register a Card' button)
- Fingerprint 1 Serial Number: 27_1 (with 'Fingerprint Scan' and 'Delete' buttons)
- Fingerprint 2 Serial Number: 27_2 (with 'Fingerprint Scan' and 'Delete' buttons)
- Picture: [User Profile Picture]

The fingerprint management section (rows 7 and 8) is highlighted with a red dashed border.

DACM (Door Access Control Manager)

Access Log Management

The screenshot shows a web browser window displaying the 'Door Access Control System' interface. The page title is 'Door Access Control System' and the URL is '172.16.1.19/dacm/eventLog'. The user is logged in as 'Administrator'. A notification banner at the top right states 'Access control setting changed' with a link to 'Apply setting, click here to transmitting to terminal.' The main content area is titled 'Event Log' and includes a search form with fields for 'Duration' (11-07-10 to 11-08-09), 'User Extension Number', and 'Event Level' (set to 'Error'). Below the search form is a table of event logs with columns for 'Time', 'Level', 'User Extension', and 'Event'. The table contains 7 entries. At the bottom of the page, there is a pagination control showing 'Page 1 of 1' and a total count of 'Total: 7'. The footer includes the 'AddPac' logo and copyright information: 'Copyright © 2011 AddPac Technology, Inc.'

| | Time | Level | User Extension | Event |
|---|---------------------|-------------|----------------|----------------------------------------|
| 1 | 2011-07-15 10:27:27 | Warning | 1000 | authentication failure |
| 2 | 2011-07-15 11:25:27 | Notice | 1000 | registration success |
| 3 | 2011-07-15 12:21:27 | Notice | 1200 | registration success |
| 4 | 2011-07-16 09:27:27 | Information | 1201 | door opened |
| 5 | 2011-07-16 11:27:27 | Information | 1007 | registration success |
| 6 | 2011-07-16 17:12:00 | Notice | | security profile downloading completed |
| 7 | 2011-07-17 18:00:00 | Notice | | system started |



Time Attendance Web Manager Software (TAAM)

TAAM (Time and Attendance Manager)

Monthly Attendance Rules

Door Access Control System

172.16.1.19/dacm/monthlyWorkRuleList

Monthly Attendance Rule List

Shows list of monthly based attendance rule for time(week, full day off, national holiday)

| Name | Description |
|-----------------------|----------------------------------|
| 1 Default Rule | Default attendance rule |
| 2 Head Office Rule | Head office work monthly rule |
| 3 Factory First Rule | Factory first work monthly rule |
| 4 Factory Second Rule | Factory second work monthly rule |

1. Monthly Rule

Defines day off or work day from starting first week to sixth week of the month. Each day of the week can be applied to daily-based attendance rule.

Rule Name*

Description

1st week: Sun Mon Tue Wed Thu Fri Sat

2nd week: Sun Mon Tue Wed Thu Fri Sat

3rd week: Sun Mon Tue Wed Thu Fri Sat

4th week: Sun Mon Tue Wed Thu Fri Sat

5th week: Sun Mon Tue Wed Thu Fri Sat

6th week: Sun Mon Tue Wed Thu Fri Sat

*Clicked: Full Day Off *Non-Clicked: Work Day

Sunday: N/A

Monday: N/A

Tuesday: N/A

Wednesday: N/A

Thursday: N/A

Friday: N/A

Saturday: N/A

2. Holiday Rule

Defines rule for non-working day such as national holiday, user defined holiday in the day template.

| Day Template List | |
|-------------------|-----------------------------|
| Name | Description |
| public holiday | public holiday description |
| company holiday | company holiday description |

| List of applied Day Templates | |
|-------------------------------|-------------|
| Name | Description |

Annotations:

- Day of week rule from 1st week to 6th week and grey color means full day off, other color is work day
- You can specify daily rule from the list for sunday through saturday

AddPac Copyright © AddPac 1999-2011 All Rights Reserved

TAAM (Time and Attendance Manager)

Business Trip and Vacation

The screenshot shows the 'Business Trip and Vacation' section of the TAAM application. It includes a table with two entries: a business trip and a vacation. Annotations explain that multiple users can be specified for a business trip, that extension users are not processed as absentees during the trip period, and that user-defined time and attendance codes are used for reporting and corrections.

| Name | Description | User | Type | Start | End | Date Created | Modify | Delete |
|---------------------|------------------------|---------------------|---------------|------------|------------|-------------------|--------|--------|
| 1 Rusia Business... | Presentation for Ne... | Total 2 includin... | Business trip | 2011-09... | 2011-10... | | | |
| 2 Summer Vacati... | | | Vacation | 2011-08... | 2011-08... | 2011-10-12 07:... | | |

one or more user can be specified for each business trip and vacation rule.

Extension user will be not processed as absentee between start day and end day, also log as user-defined time attendance code

user-defined time and attendance code for attendance report or log correction

TAAM (Time and Attendance Manager)

Time and Attendance Codes

The screenshot shows a web browser window with the URL `172.16.1.19/dacm/timeAttendanceCodeList`. The page title is "Time and Attendance Manager" and the user is logged in as "root". The main content area is titled "Time and Attendance Codes" and includes a description: "Shows list of user defined attendance code which can be used as correction in the attendance report." There is an "Add a Code" button. A table lists the following codes:

| Name | Description | Date Created | Modify | Delete |
|---------------------|--------------------------|---------------------|--------|--------|
| 1 Unknown | | | | |
| 2 Not yet defined | | | | |
| 3 Late In | | | | |
| 4 Early Out | | | | |
| 5 Absence | | | | |
| 6 Late In/Early Out | | | | |
| 7 Normal | | | | |
| 8 Vacation | | | | |
| 9 Business trip | | | | |
| 10 Sick Leave | Sick Leave code by admin | 2011-11-07 14:44:15 | | |

Annotations on the screenshot:

- A yellow dashed box highlights the first 10 rows of the table, with a callout: "show built-in and user-defined time and attendance code which will be used in the attendance report and log correction".
- A yellow box highlights the first 9 rows, with a callout: "system built-in time and attendance code is provided as default, for example late-in, early-out and absence".
- A yellow box highlights the 'Delete' column for the 'Sick Leave' row, with a callout: "only user-define code can be removed if needed".

Footer: AddPac Copyright © AddPac 1999-2011 All Rights Reserved. Version 1.1.14

TAAM (Time and Attendance Manager)

Delivery Policy for Attendance Report

1. Report Policy
Defines email delivery policy for manager or each user to receive daily, monthly attendance report.

Send reports to the particular person every day at 08:00

Send reports to the particular person at specific day (28) of every month. 08:00

User List

| Name | Department | Extension |
|------|------------|-----------|
|------|------------|-----------|

Applied user list

| Name | Department | Extension |
|----------------|------------|-----------|
| batista Eike | /2F/ | 1000 |
| Stefan Persson | /2F/ | 1016 |

Send personal monthly report to each user.

2. SMTP Server
You can specify sending email server(SMTP) configurations.

SMTP Server: 61.33.161.2

Sender Email Address: dacs_admin@company.com

Server Authentication Required

User ID: admin

Password: ****

To apply this features, select 'Apply' or 'Cancel'

Apply Cancel

manager level users (extension) list who want to receive daily and monthly attendance report

if checked, system will send personal attendance report of each month to extension user

TAAM (Time and Attendance Manager)

Attendance Report by Date

Time and Attendance Manager

Home Policy Trip and Vacation Report Configuration Report View

Attendance Report by Date
Shows attendance log for each user and summary information with specified day.

Select Date : 2011-10-19
Select Department : All

Attendance Report by Date (2011-10-19)

Type

| Type | Count |
|-----------|-------|
| Late In | 1 |
| Early Out | 1 |
| Normal | 10 |

| | Username | Department | In | Out | Overtime | Office Hc | Result | Correction Ti | Correct |
|---|------------------|-------------------|----------|----------|----------|-----------|-----------|---------------|---------|
| 1 | Eike batista | smart management팀 | 08:05:00 | 18:05:00 | 0 hr | 10:0... | Normal | | |
| 2 | Bill Gates | multimedia팀 | 09:15:00 | 17:15:00 | 0 hr | 08:0... | Normal | 2011-11-... | |
| 3 | Larry Ellison | multimedia팀 | 09:00:00 | 18:00:00 | 0 hr | 09:0... | Normal | | |
| 4 | karl Albrecht | smart framework팀 | 09:00:00 | 17:00:00 | 0 hr | 08:0... | Early Out | | |
| 5 | Carlos Slim Helu | smart management팀 | 09:10:00 | 19:10:00 | 0 hr | 10:0... | Normal | | |
| 6 | Lakshmi Mittal | multimedia팀 | 09:00:00 | 18:00:00 | 4 hr | 09:0... | Normal | | |
| 7 | Christy Walton | smart framework팀 | 09:00:00 | 18:00:00 | 0 hr | 09:0... | Normal | | |

You can export to excel or print out for attendance report

attendance summary for each time and attendance code with specified date

administrator may adjust or correct attendance log which system have processed if necessary

TAAM (Time and Attendance Manager)

Attendance Report Excel Export

| Attendance Report by Date (2011-10-19) | | | | | | | |
|-----------------------------------------------|------------------|----------|----------|----------|--------------|-----------|------------------------|
| Username | Department | In | Out | Overtime | Office Hours | Result | Correction Time |
| Eike batista | smart management | 08:05:00 | 18:05:00 | 0 hr | 10:00:00 | Normal | |
| Bill Gates | multimedia | 09:15:00 | 17:15:00 | 0 hr | 08:00:00 | Normal | 2011-11-07 14:52:28 |
| Larry Ellison | multimedia | 09:00:00 | 18:00:00 | 0 hr | 09:00:00 | Normal | |
| karl Albrecht | smart framework | 09:00:00 | 17:00:00 | 0 hr | 08:00:00 | Early Out | |
| Carlos Slim Helu | smart management | 09:10:00 | 19:10:00 | 0 hr | 10:00:00 | Normal | |
| Lakshmi Mittal | multimedia | 09:00:00 | 18:00:00 | 4 hr | 09:00:00 | Normal | |
| Christy Walton | smart framework | 09:00:00 | 18:00:00 | 0 hr | 09:00:00 | Normal | |
| Lika Shing | smart framework | 09:20:00 | 18:20:00 | 0 hr | 09:00:00 | Late In | |
| Stefan Persson | smart framework | 09:00:00 | 20:00:00 | 2 hr | 11:00:00 | Normal | |
| Warren Buffett | multimedia | 09:15:00 | 18:15:00 | 0 hr | 09:00:00 | Normal | |
| Amancio Ortega | smart management | 09:00:00 | 21:00:00 | 3 hr | 12:00:00 | Normal | |
| Mukesh Ambani | smart management | 09:00:00 | 18:30:00 | 0 hr | 09:30:00 | Normal | |

TAAM (Time and Attendance Manager)

Attendance Report by Month



attendance summary for each time and attendance code with specified month

attendance summary for each extension user

TAAM (Time and Attendance Manager)

Attendance Daily Report by Month

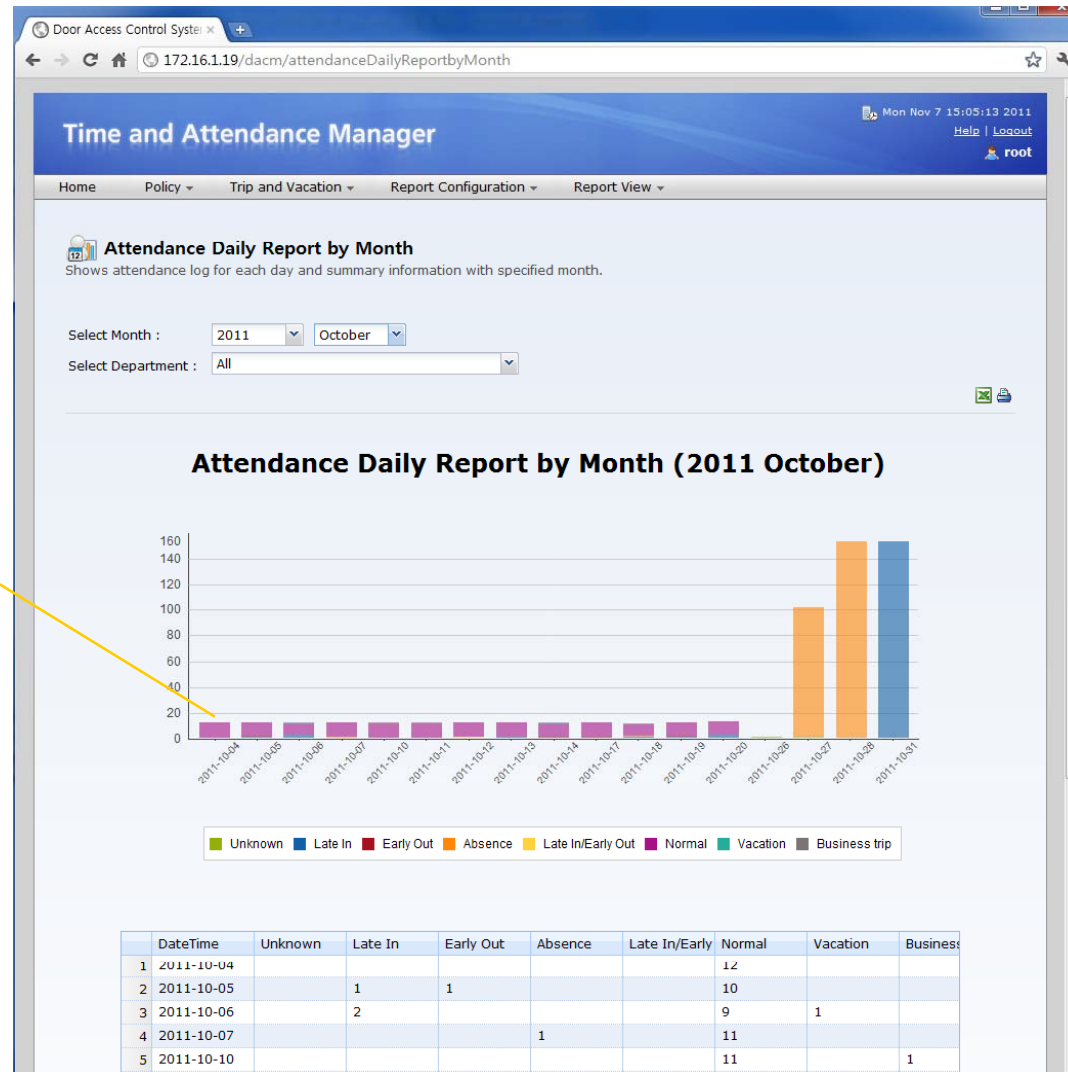

clustered column of attendance summary with time span from first to end of the month



Door Access Control Server Open API

Open API

Open API for 3'rd Party Management System

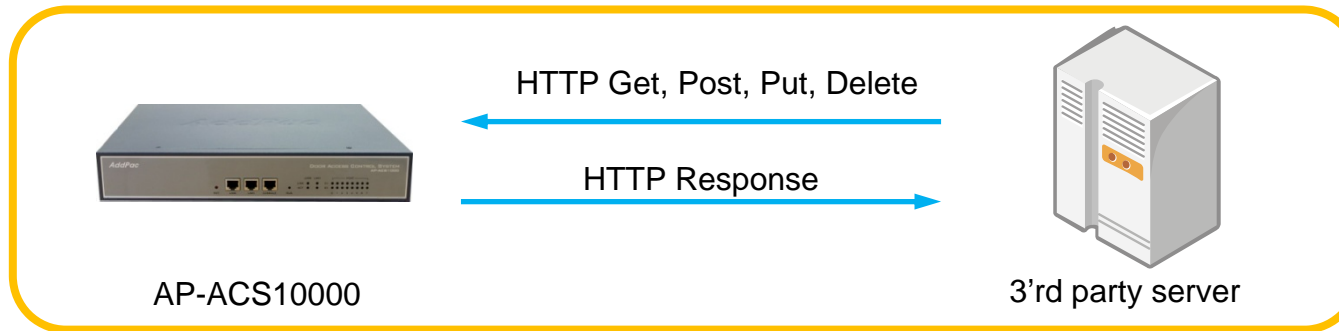

- HTTP based RESTful Open API for Door Access Management
- XML based Flexible and Expandable Message Contents
- Provides More than 40 APIs as Bellow
 - user_list(GET), user(GET, POST, PUT, DELETE), ...
 - terminal_list(GET), terminal(GET, POST, PUT, DELETE), ...
 - access_group(GET, POST, PUT, DELETE), priority (PUT), ...
 - card_list(GET), card(POST, PUT, DELETE), ...
 - schedule_template(GET, POST, PUT, DELETE), rule(GET, POST, PUT, DELETE) ,...



Thank you!

AddPac Technology Co., Ltd.
Sales and Marketing

Phone +82.2.568.3848 (KOREA)

FAX +82.2.568.3847 (KOREA)

E-mail : sales@addpac.com