

AP-VWP100

Smart IP Video Wall PAD

High Performance IP Video Wall PAD Solution

Sensor Network Interworking for Sensor Devices



AddPac

AddPac Technology

Sales and Marketing

www.addpac.com

Contents

- Smart Home Application Network Diagram
- Smart Hub Solution for Sensor Devices
- AddPac IP Video Wall PAD Sensor Network Interworking

Smart Home Application Network Diagram

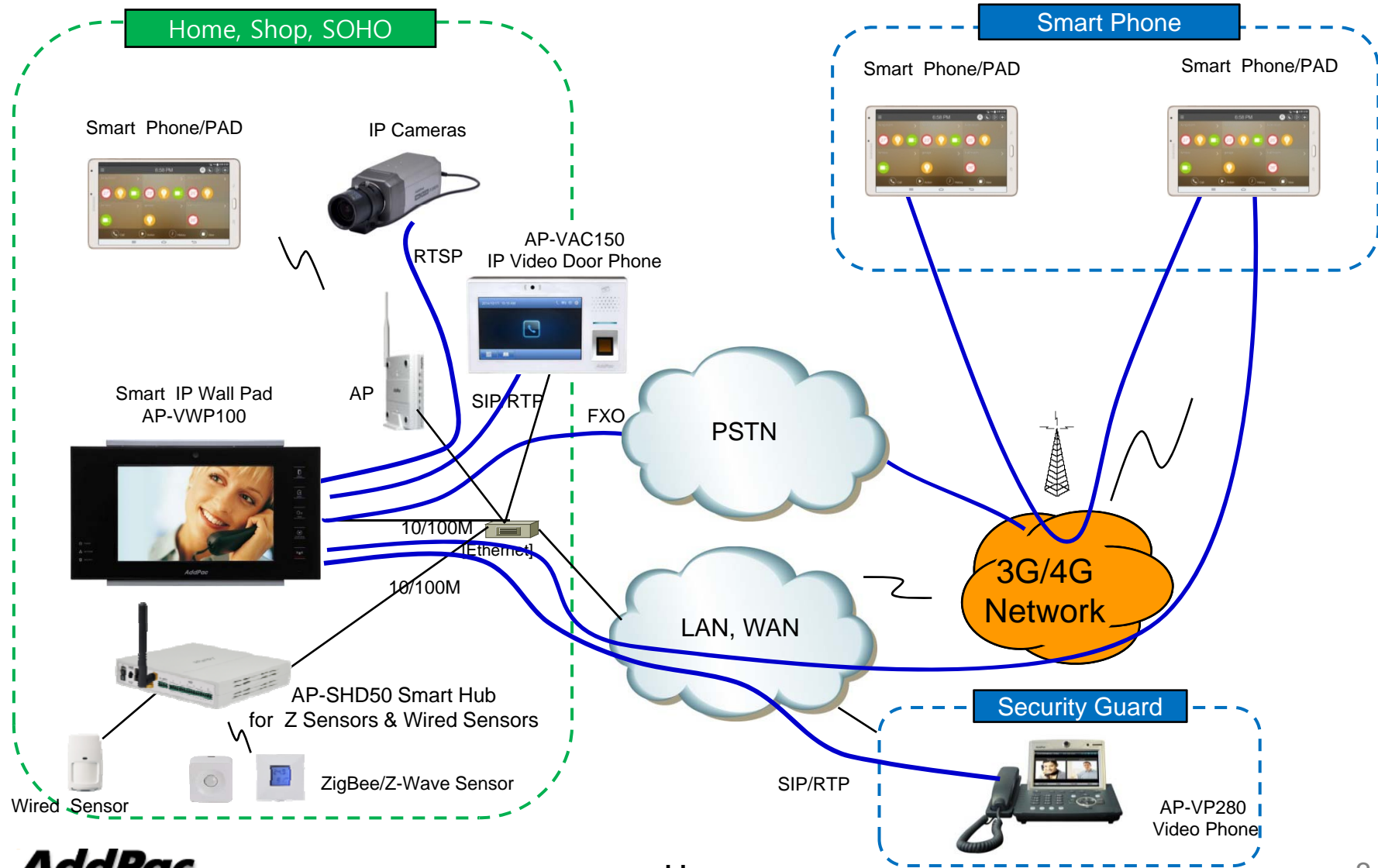







Smart Hub Solution

Contents

- Smart Home Equipment Table
- Smart Hub Solution Features (Advantage)
- Smart Hub Equipment Table
- Smart Hub Service Diagram
- Smart Hub Equipment for Sensor Devices
 - AP-SH50 (Zigbee/Zwave)
 - AP-SAH50 (Wired)
 - AP-SHD50 (Zigbee/Zwave, Wired)



Smart Home Equipment Table

Smart Home Products	Description	Model
	Smart Wall PAD	AP-VWP100, AP-VWP90, AP-VWP80
	IP Video Door Phones	AP-VAC20, AP-VAC50, AP-VAC80, AP-VAC150
	IP Video Phone (Bidirectional two-way video)	AP-VP280, AP-VP120, etc
	Smart Hub for Zigbee/Zwave Sensors	AP-SH50, AP-SAH50, AP-SHD50
	Smart Phone and Tab/Pad Appl.	

Smart Hub Solution Features

- Powerful Standalone Model: Smart Wall Pad or Smart Hub has full capability to provide smart home service to user via intranet or Internet. This model supports internal web server and also supports clone mode service beside standalone mode service.
- Flexible Multi-tenant Condominium Model (Clone Model) : Smart Home Server provides multi-tenant smart home solution including lobby camera, outdoor camera, and main entrance door phone. The Smart Hub for large apartment has minimum resource to LAN bridge smart home sensor device to Smart Home Server
- Smart Hub has interface for legacy wired devices and Wireless ZigBee / Z-Wave devices
 - It also support extended long cable antenna interface for enhancing wireless distance and flexible installation spot.(underground, outdoor, etc)
- Support Multiple Smart Hubs for Large Premise
 - A smart home user can install multiple Smart Hubs extending wireless limit.
- Provides Powerful Call Scenarios between SIP terminals.
 - Smart Wall Pad and Smart Hub provides call between SIP video door phone, SIP door phone, Android / I-Phone Smart Home App, PSTN phone, and other subscribers Smart Wall pads.
- Provides Zone based Intuitive UI
 - Zone Summary UI provides intuitive and easy UI for handling alarm and devices.

Smart Hub Equipment Comparison Table

Model	AP-SH50	AP-SAH50	AP-SHD50
Service Features			
Sensor Type	Wireless Zigbee, Zwave	Wired	Wireless/Wired Zigbee, Zwave
Wired Sensor Port	N/A	6-Port	6-Port
Smart Appl. for Phone, PAD	Support	Support	Support
Smart Web Manager	Support	Support	Support
LAN Port	1	1	1
PoE(Optional)	Option	Option	Option

Smart Hub Service Diagram (Smart Home Solution)

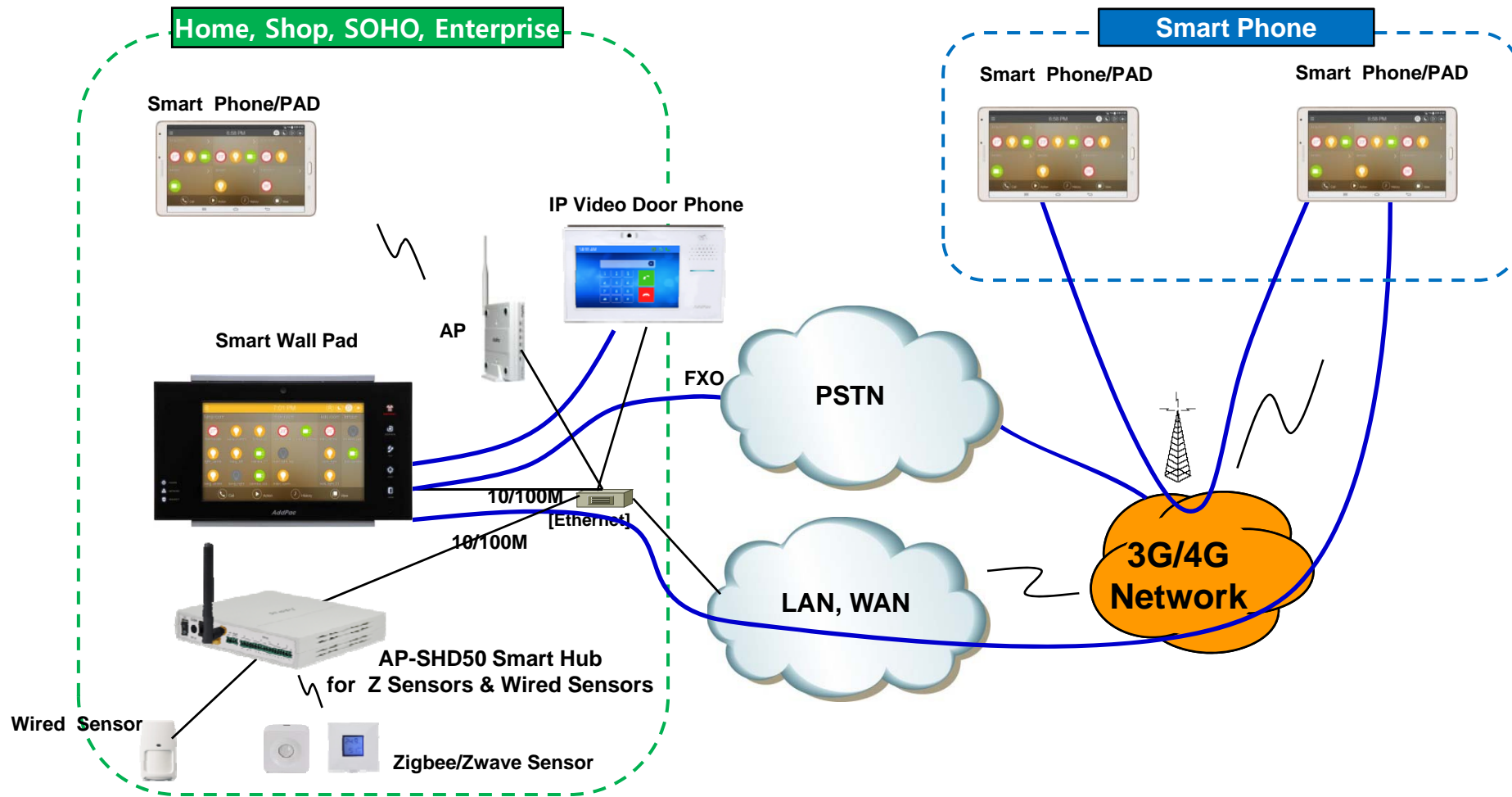

Smart Hub Service Diagram (Standalone Type Smart Hub Device)

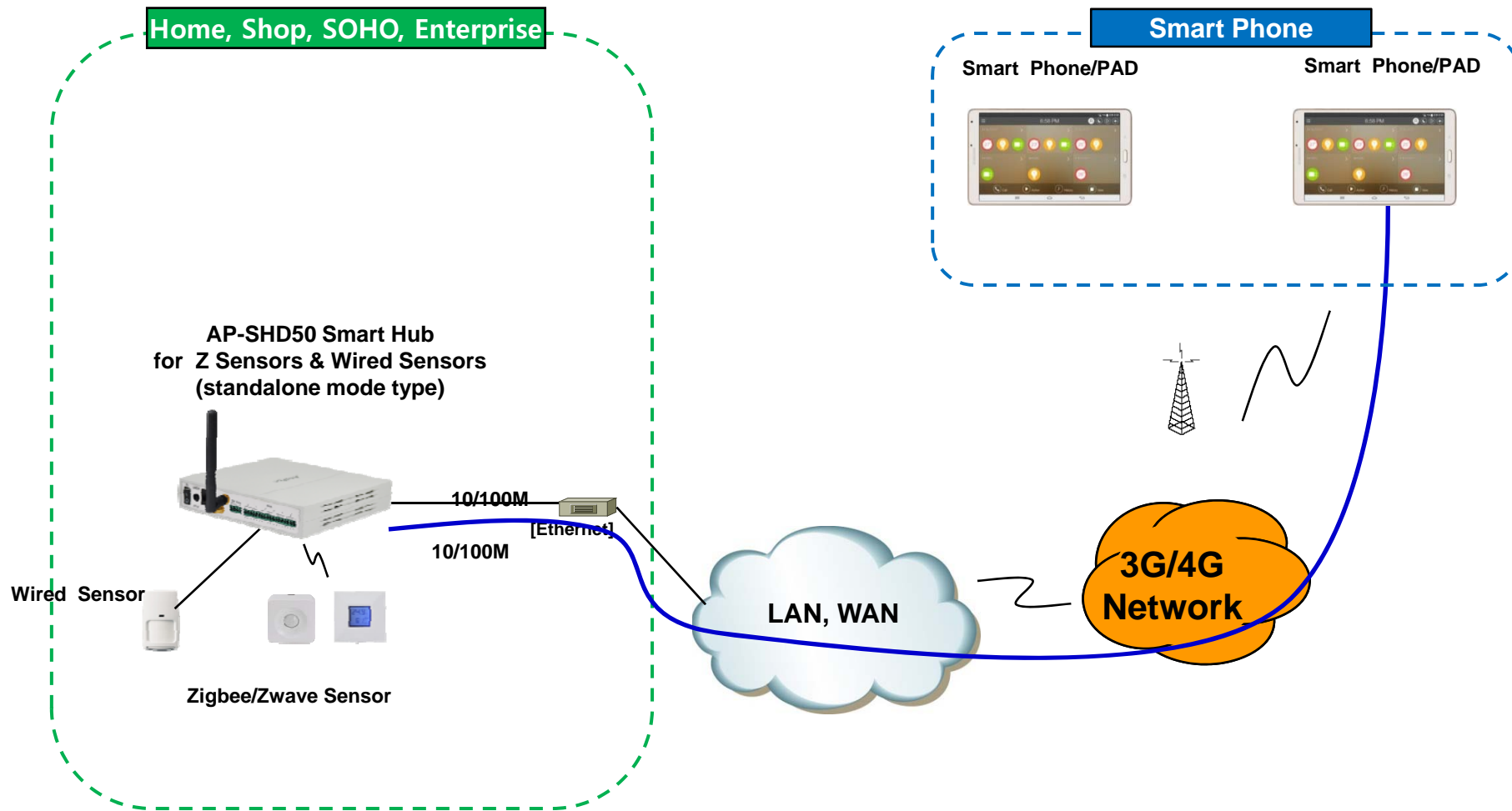

Smart Hub Service Diagram (Clone Type Smart Hub Device)

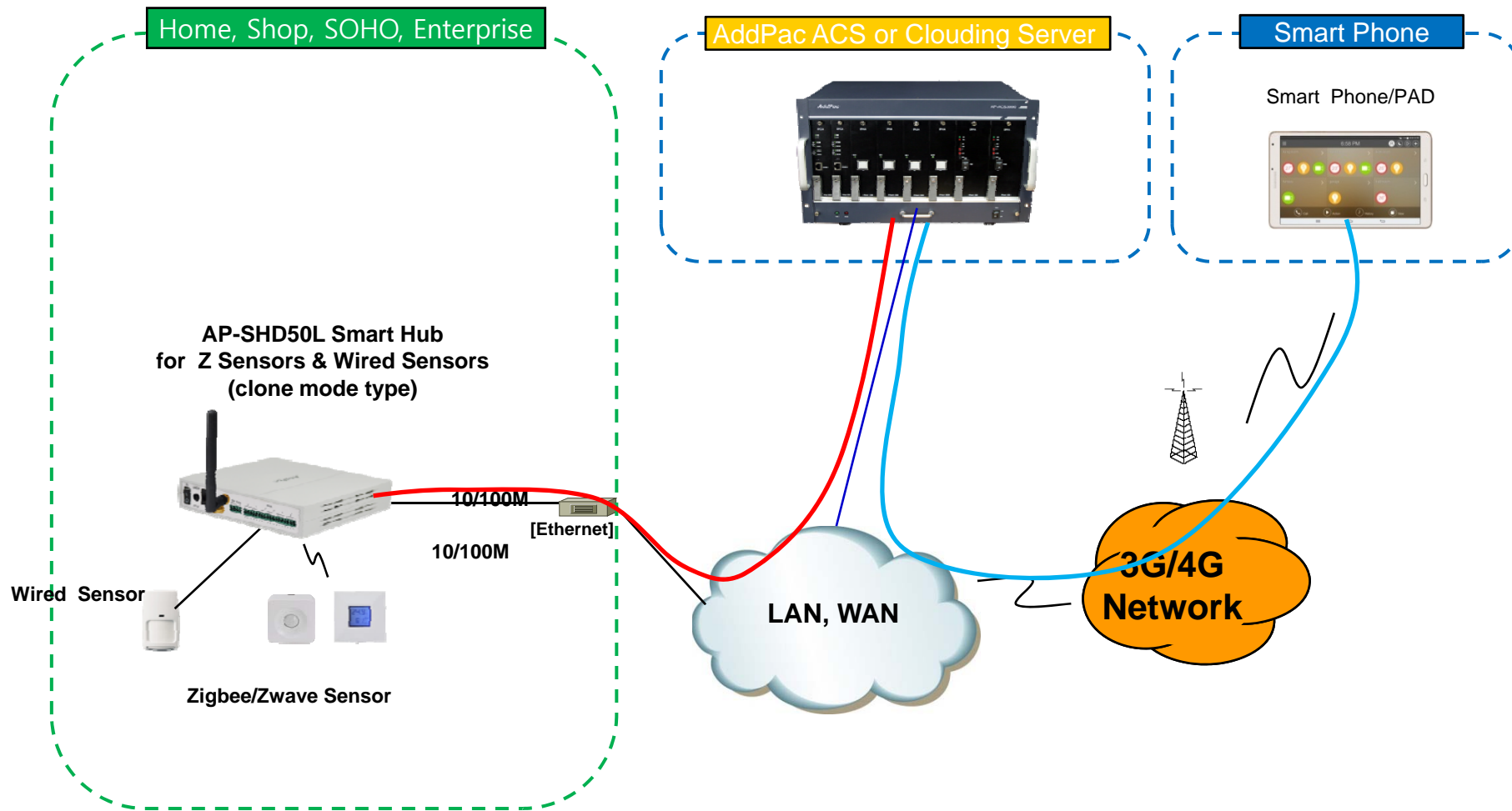



Smart Hub Equipment for Sensor Devices



AP-SH50 Smart Hub

Product Overview

AP-SH50 Smart Hub for Z sensors

- Advanced Smart Home Solution
- Zigbee/Zwave Dual Sensor Interface Support
- Smart IP Routing Service Features for Sensor Network
- Smart Wall Pad Interworking Service Features
- Smart Hub Interworking Support for Third Party
- High Performance RISC Programmable Architecture
- One 10/100Mbps Fast Ethernet
- High Performance LAN-to-Zigbee/Zwave Routing Capability
- Powerful Network Protocols (PPPoE, DHCP, Static Routing, etc)
- Firmware Upgradeable Architecture
- Smart Web based Management
- Light and Compact Design with External Power Supply

Hardware Specification

AP-SH50 Smart Hub for Z sensors

- RISC Microprocessor Computing Power
- 1-Port Zigbee Interface
- 1-Port Zwave Interface
- 1-Port Zigbee Antenna
- 1-Port Zwave Antenna
- Speaker & Beacon Port
- Network Interface
 - One(1) 10/100Mbps Fast Ethernet (RJ45)
- Run LED, LAN LED, Port LEDs
- External Power Supply

Hardware Specification

AP-SH50 Smart Hub for Z sensors

Smart Hub Service Diagram

AP-SH50 Smart Hub Internal H/W Block Diagram

Zigbee Sensors

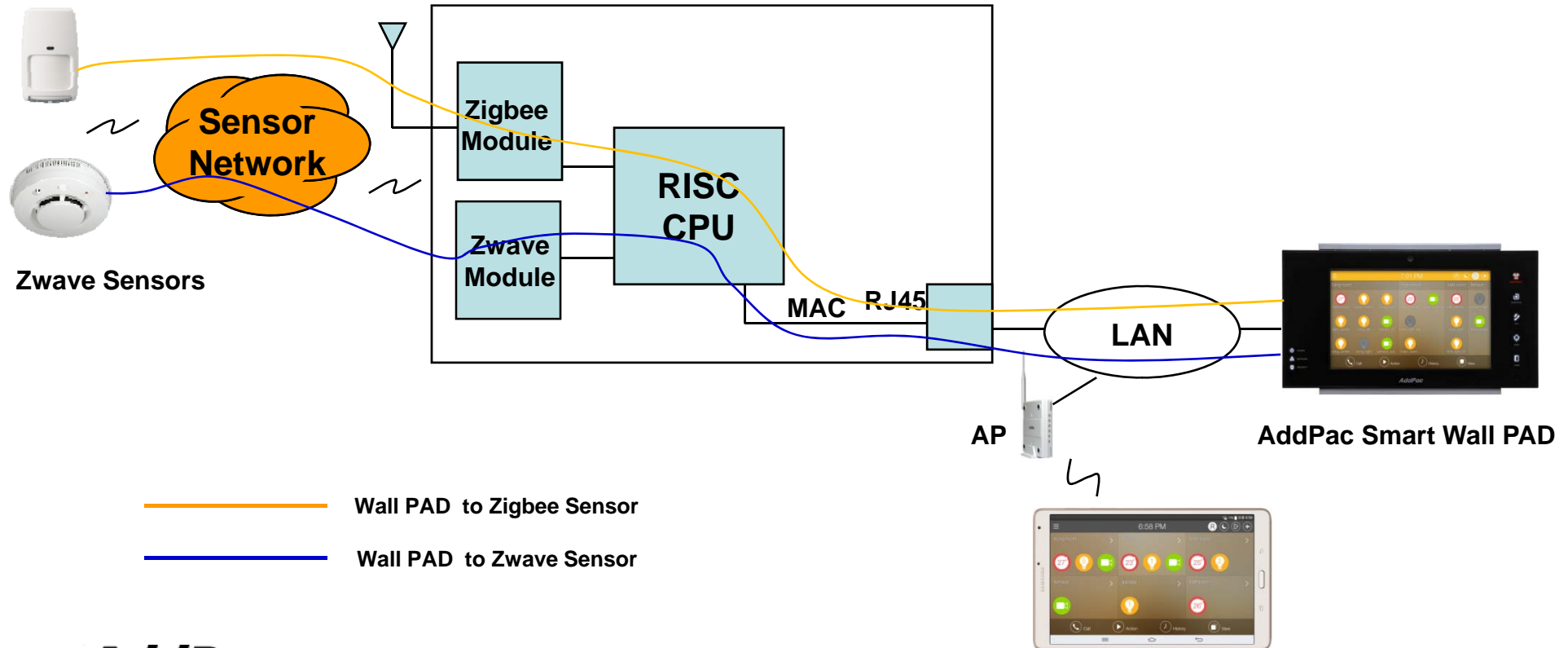

Hardware Specification

AP-SH50 Smart Hub for Z sensors

Network interface Configurations

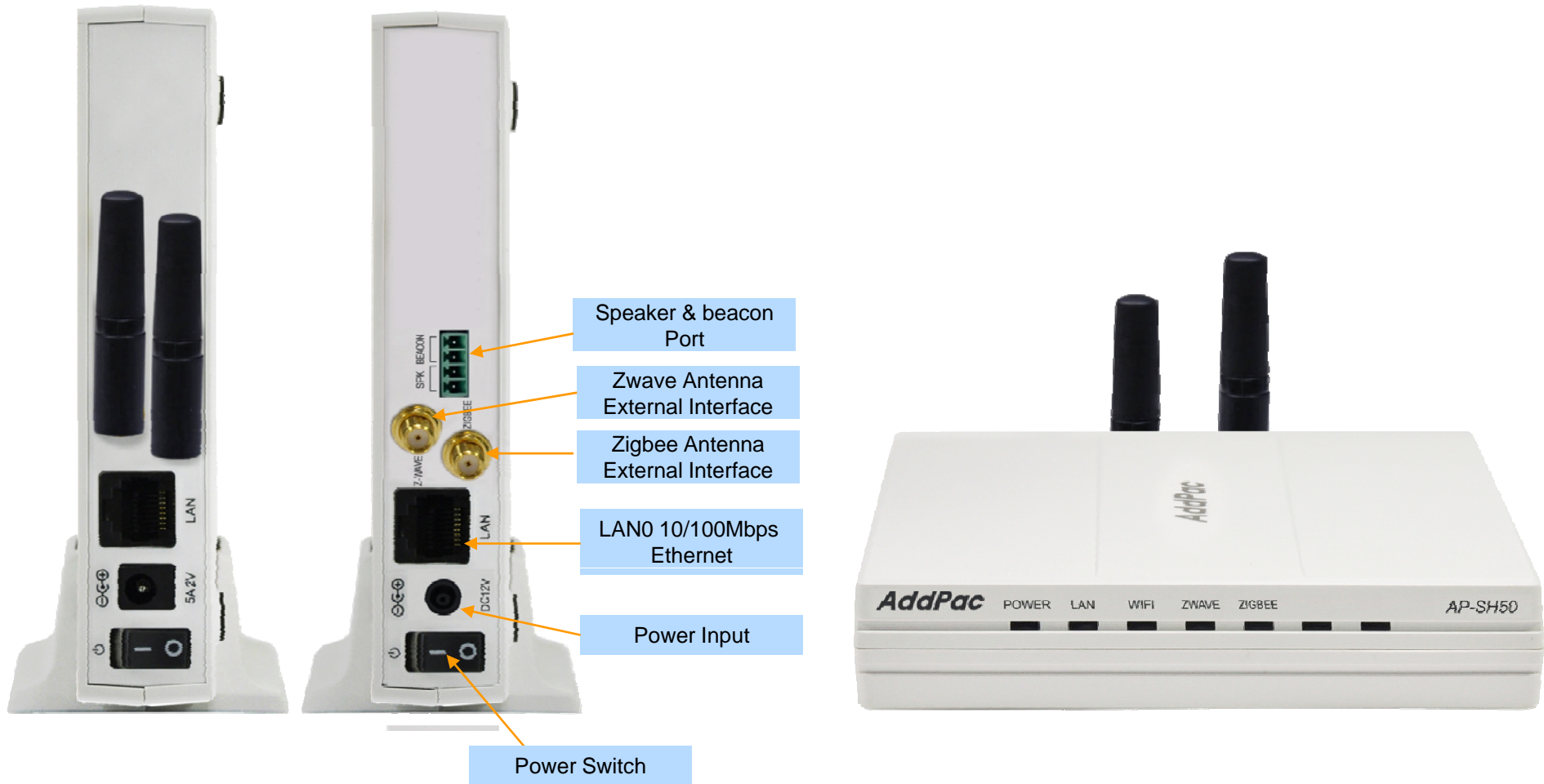



AP-SAH50 Smart Hub

Product Overview

AP-SAH50 Smart Hub for Legacy Wired Sensors

- Advanced Smart Home Solution
- Legacy Wired Sensor Interface Support
- Smart IP Routing Service Features for Sensor Network
- Smart Wall Pad Interworking Service Features
- Smart Hub Interworking Support for Third Party
- High Performance RISC Programmable Architecture
- One 10/100Mbps Fast Ethernet
- PoE Support : Option
- High Performance LAN-to-Wired Legacy Sensor Routing Capability
- Powerful Network Protocols (PPPoE, DHCP, Static Routing, etc)
- Firmware Upgradeable Architecture
- Smart Web based Management
- Light and Compact Design with External Power Supply

Hardware Specification

AP-SAH50 Smart Hub for Legacy Wired Sensors

- RISC Microprocessor Computing Power
- 6-Port Wired Sensor
 - Alarm Input
 - Power Output for Sensor Power Supply
- Speaker Port, Beacon Port
- Network Interface
 - One(1) 10/100Mbps Fast Ethernet (RJ45)
- LAN LED, Sensor Port LED
- External Power Supply
- PoE (Power over Ethernet) : Option

Hardware Specification

AP-SAH50 Smart Hub for Legacy Wired Sensors

Smart Hub Service Diagram

AP-SH50 Smart Hub Internal H/W Block Diagram

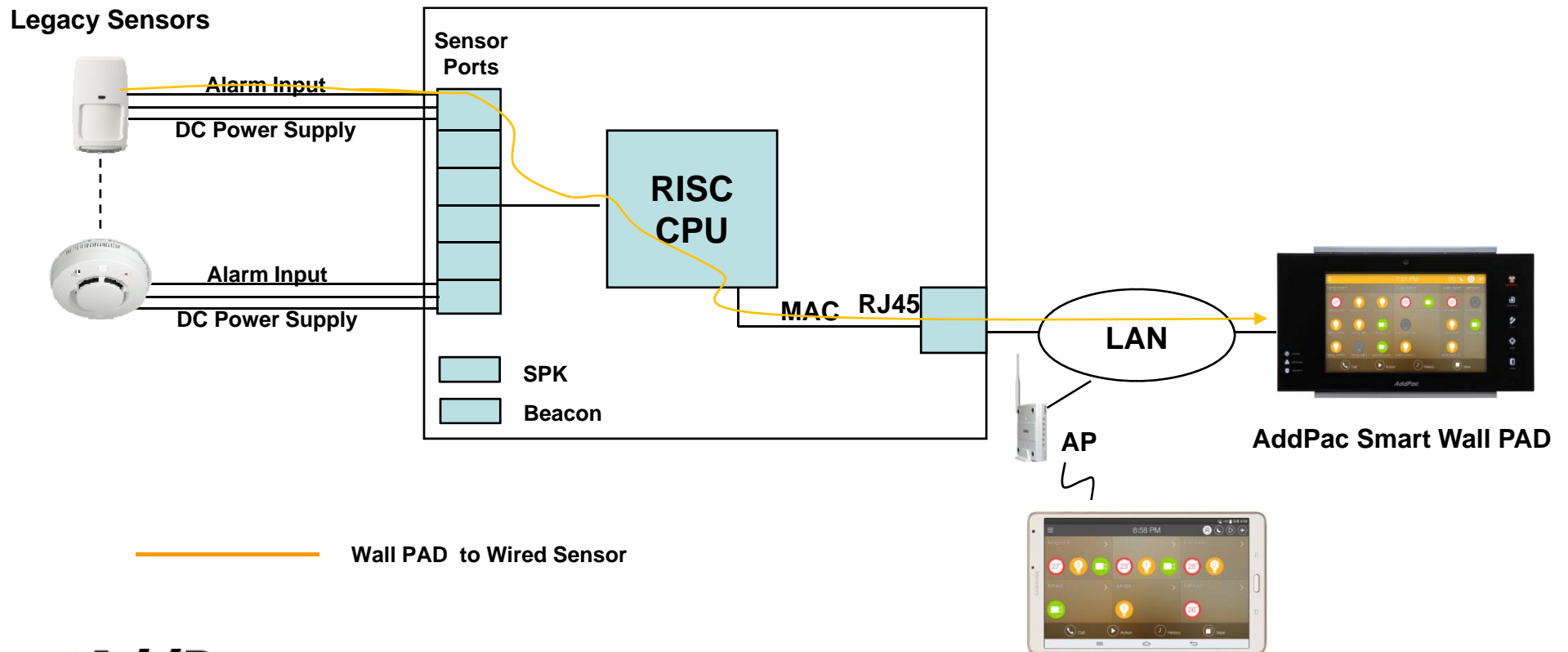

Hardware Specification

AP-SAH50 Smart Hub for Legacy Wired Sensors

Back Side

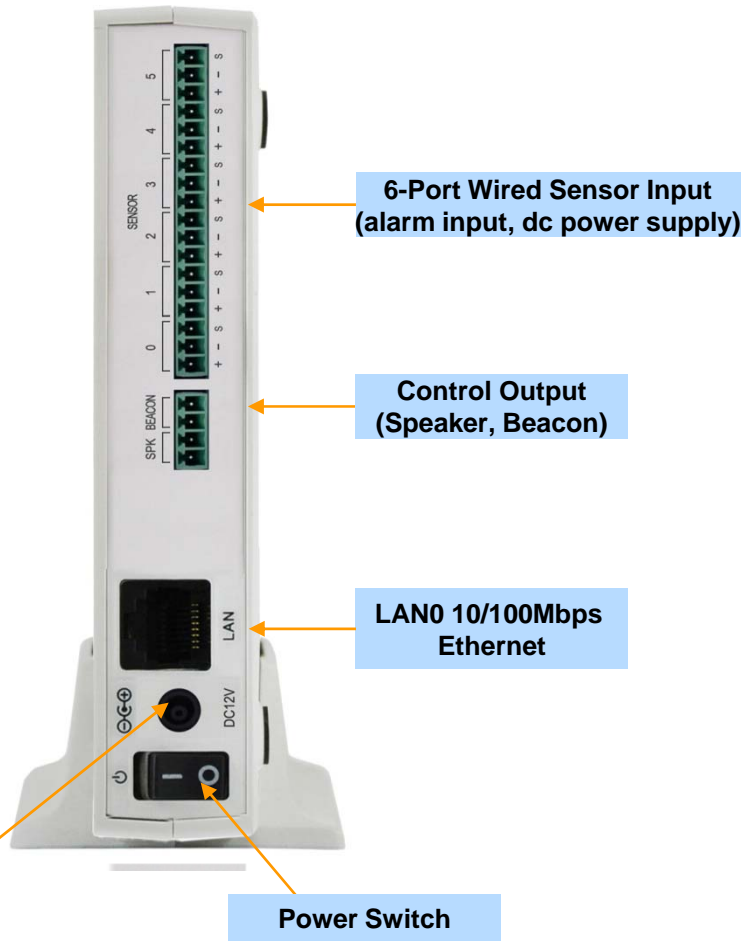

Front Side

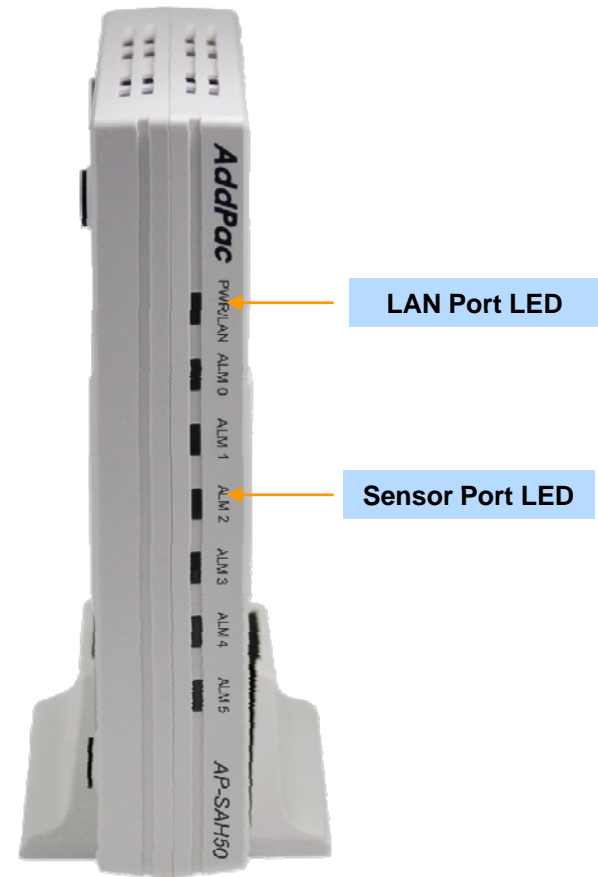



AP-SHD50 Smart Hub

Product Overview

AP-SHD50 Smart Hub for Z Sensors & Wired Sensors

- Advanced Smart Home Solution
- Zigbee/Zwave Dual Sensor Interface Support
- Legacy Wired Sensor Interface Support
- Smart IP Routing Service Features for Sensor Network
- Smart Wall Pad Interworking Service Features
- Smart Hub Interworking Support for Third Party
- High Performance RISC Programmable Architecture
- One 10/100Mbps Fast Ethernet
- PoE Support : Option
- High Performance LAN-to-Zigbee/Zwave Routing Capability
- Powerful Network Protocols (PPPoE, DHCP, Static Routing, etc)
- Firmware Upgradeable Architecture
- Smart Web based Management
- Light and Compact Design with External Power Supply

Hardware Specification

AP-SHD50 Smart Hub for Z Sensors & Wired Sensors

- RISC Microprocessor Computing Power
- 1-Port Zigbee Interface
- 1-Port Zwave Interface
- 6-Port Wired Sensor
 - Alarm Input
 - Power Output for Sensor Power Supply
- Speaker Port, Beacon Port
- Network Interface
 - One(1) 10/100Mbps Fast Ethernet (RJ45)
- LAN LED, Port LEDs
- External Power Supply
- PoE (Power over Ethernet) : Option

Hardware Specification

AP-SHD50 Smart Hub for Z Sensors & Wired Sensors

Smart Hub Service Diagram

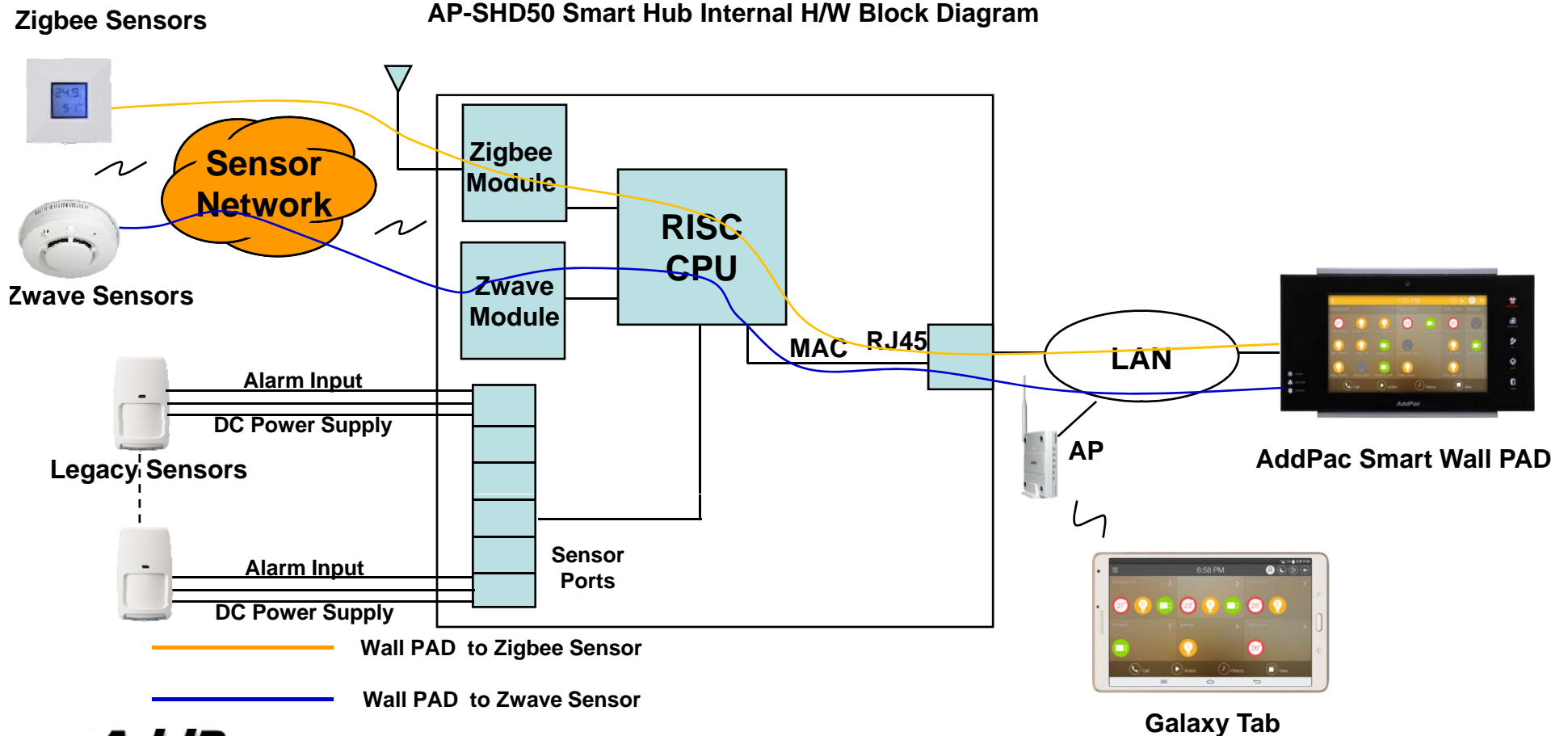

Hardware Specification

AP-SHD50 Smart Hub for Z Sensors & Wired Sensors

Network interface Configurations

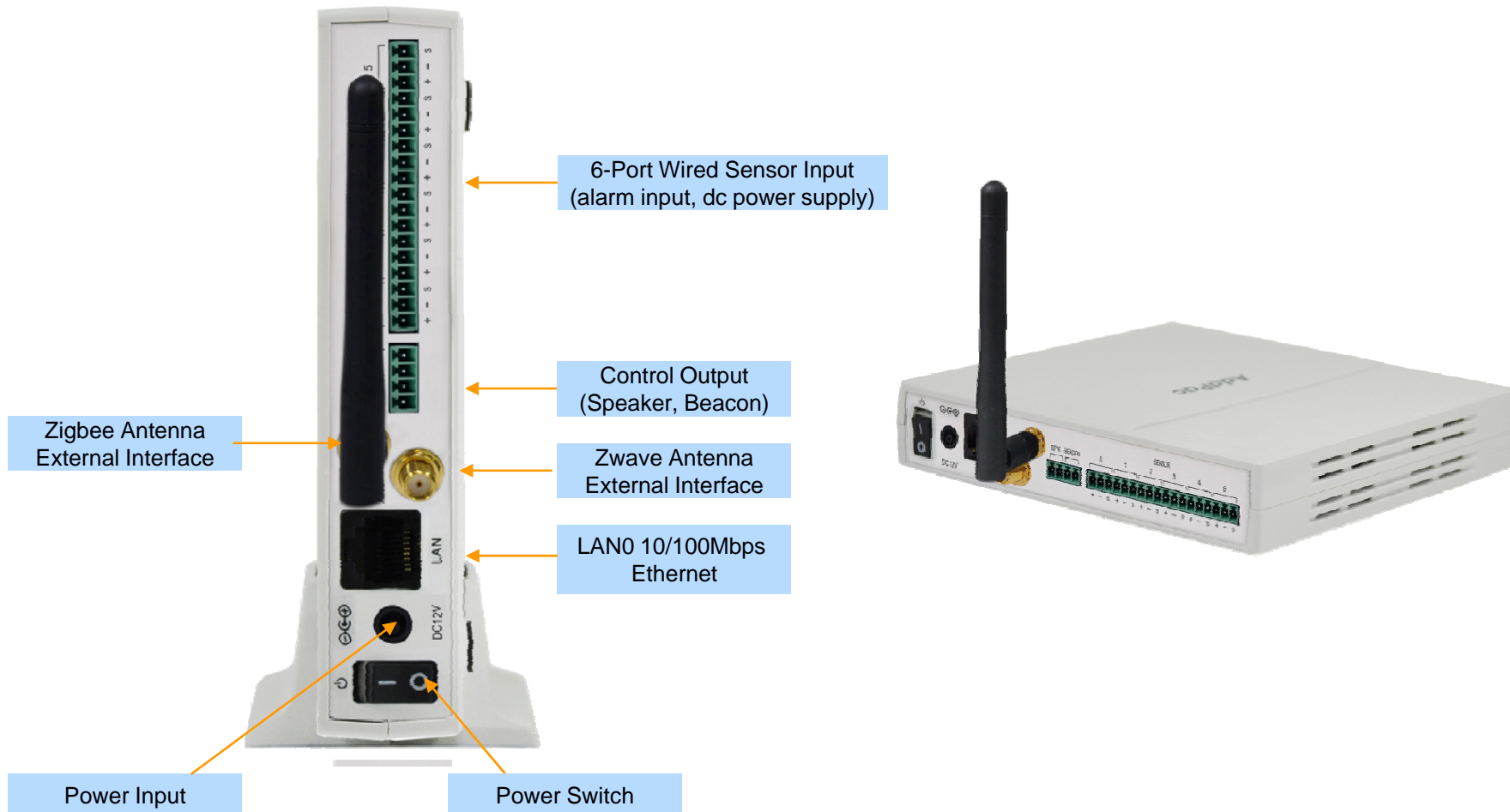



AddPac IP Video Wall PAD Sensor Network Interworking

Contents

- IP Video Wall PAD Sensor Control UI Example
- Current Supported Sensor Lists
- Additional Sensor Lists (plan to develop)
- Large Scale Smart Home Sensor Network Management with Access Control Server

Sensor Control UI Example (main detail)











Sensor Control UI Example (main detail)

















Sensor Control UI Example (main summary)





Current supported Sensor Lists

No.	sensor type	icon			description
1	Motion	 (Motion Detect)	 (normal)	 (sensor-offline)	
2	open/close	 (door/window open)	 (normal – close)	 (sensor-offline)	
3	light	 (Light Off)	 (Light On)	 (sensor-offline)	

Additional Sensor Lists (plan to develop)

No.	sensor type	icon			description
1	siren	 (alarm occurred)	 (normal)	 (sensor-offline)	
2	smoke	 (smoke/CO detect)	 (normal)	 (sensor-offline)	Smoke/CO common
3	water	 (water detect)	 (normal)	 (sensor-offline)	If water is found in some where water should be not exist, water detect alarm is occurred.
4	power outlet	 (power on)	 (power off)	 (sensor-offline)	
5	switch	 (power on)	 (power off)	 (sensor-offline)	

Additional Sensor Lists (plan to develop)

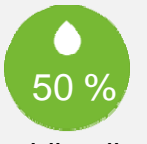
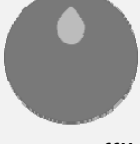
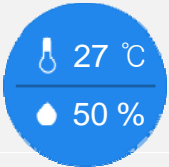
No.	sensor type	icon		description
6	Temperature	 (temperature display state)	 (sensor - offline)	
7	Humidity	 (humidity display state)	 (sensor - offline)	
	Temperature / Humidity			<ul style="list-style-type: none"> Temperature and Humidity information display at same time, not additional device



Large Scale Smart Home Sensor Network Management
with Access Management Server
(AP-ACS1000, AP-ACS2000, AP-ACS3000)

Multiple Location Sensor Network Management

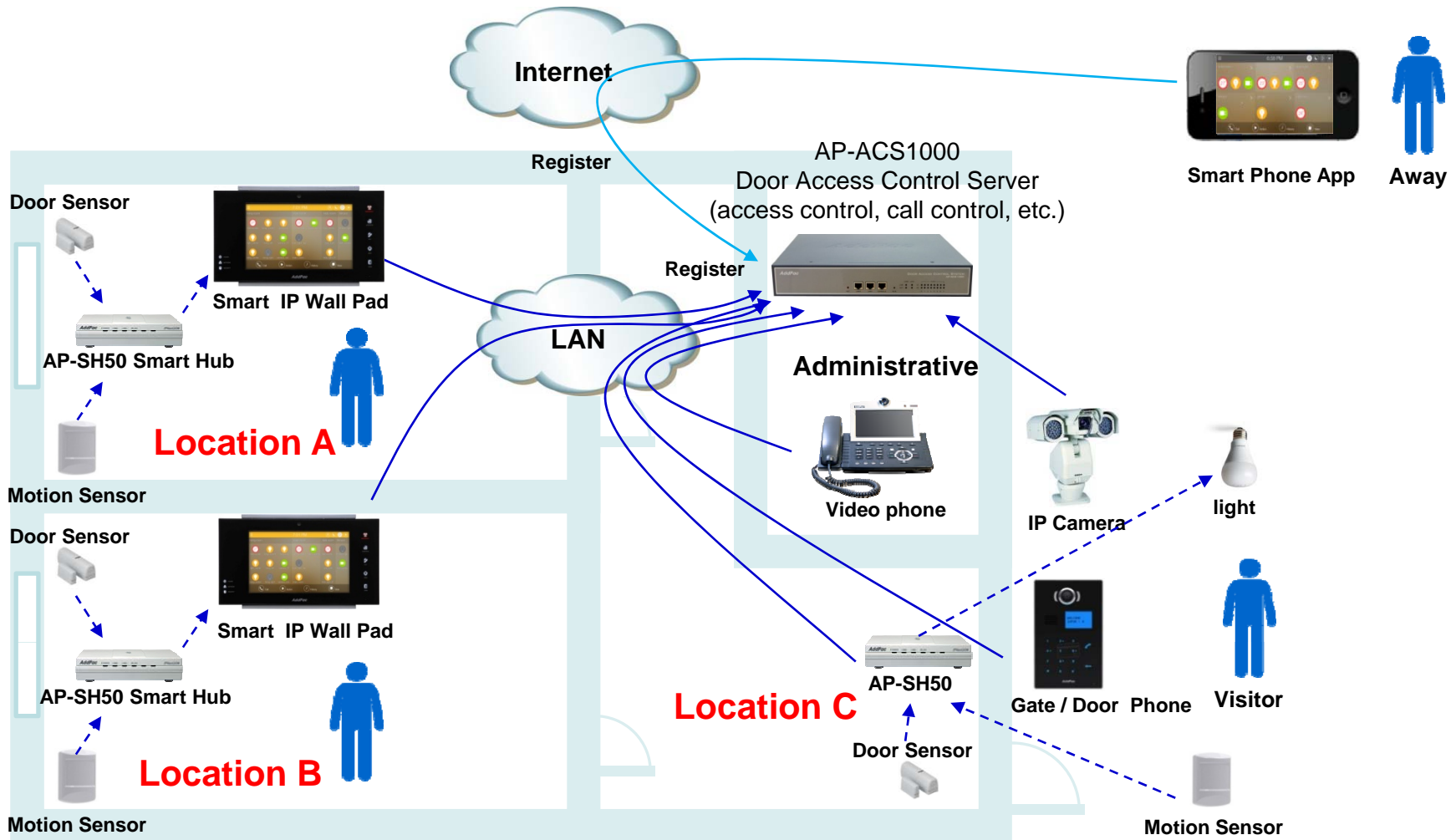

Call Control Role

- Door Access Control of Gate Phone by Finger Print, ID Card or Password.
- Call Control between Gate Phone and Smart Wall Pad
- Call Control between Gate Phone and Smart Phone App via Smart Wall Pad
- Call Control between Gate Phone and Administrative Video Phone
- Call Control between Smart Wall Pad and Administrative Video Phone
- Call Control between Smart Wall Pads
- Call Control between Smart Phone Apps

Location Management Role (Plan to develop)

- Location Add/Remove
- User Account Management
- Alarm Configuration and Notification Handling
- Action Configuration and Processing
- Schedule Management
- Summary Report
- Detail Access by Web
- Daily / Monthly Statistics
- Configuration Backup and Restore
- Energy Meter Monitoring
- IP Camera Video Recording Always or by Request



Thank you!

AddPac Technology Co., Ltd.
Sales and Marketing

Phone +82.2.568.3848 (KOREA)

FAX +82.2.568.3847 (KOREA)

E-mail sales@addpac.com