



AP250

2-Port VoIP Gateway

High Performance VoIP Gateway Solution

802.1Q + 802.1P + Bridge



AddPac

AddPac Technology

Sales and Marketing

www.addpac.com

Contents

- 802.1Q VLAN Encapsulation
- 802.1P VLAN Priority
- VLAN Bridge

802.1Q VLAN + NAT/PAT

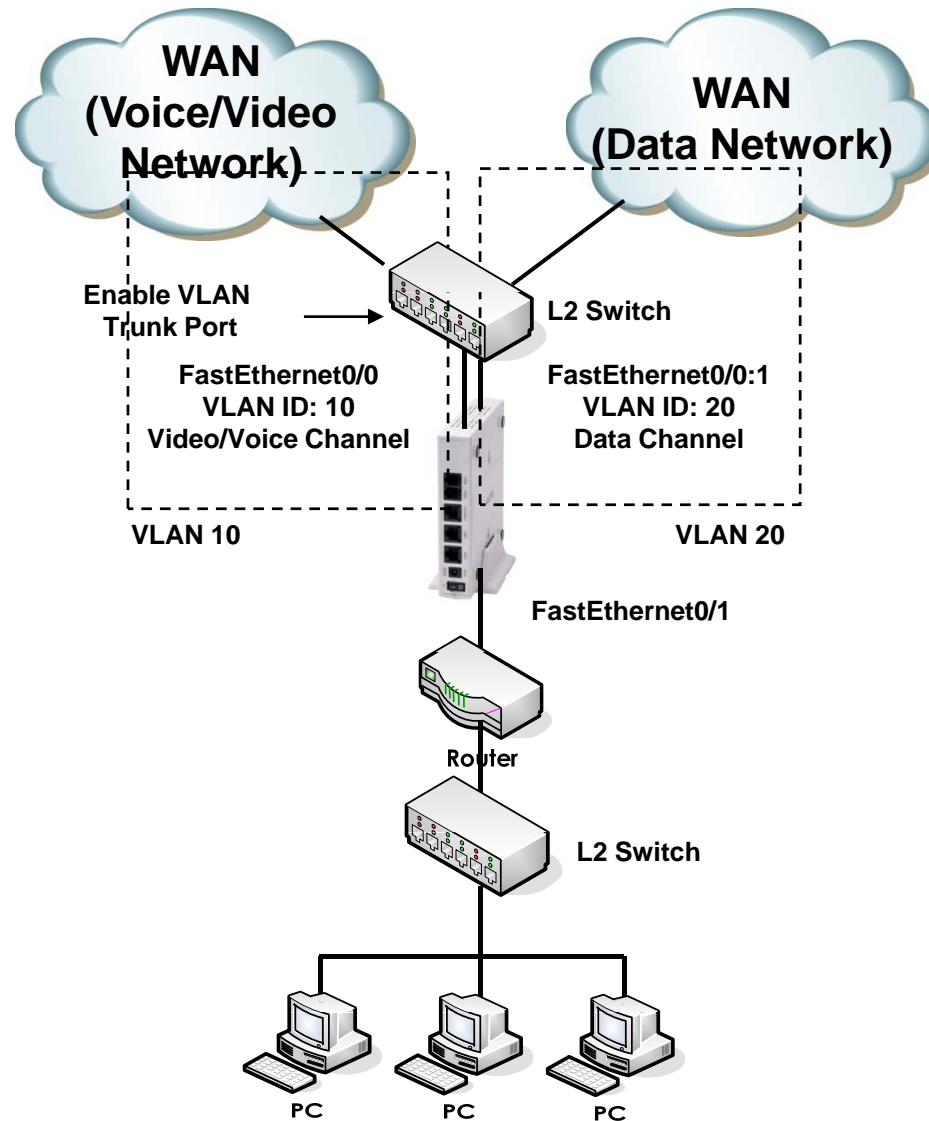

Public IP (Static IP) + NAT/PAT

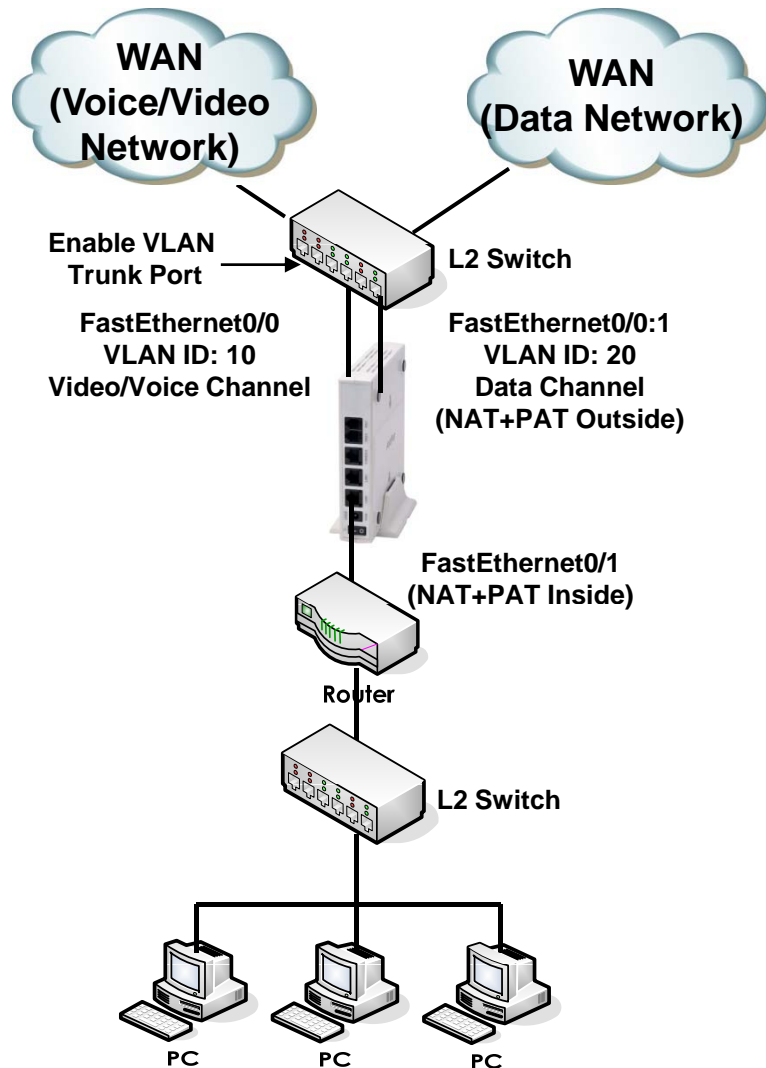

```
!  
interface Loopback0  
ip address 127.0.0.1 255.0.0.0  
!  
interface FastEthernet0/0  
ip address 200.212.149.130 255.255.255.0  
encapsulation dot1Q 10  
speed auto  
!  
interface FastEthernet0/1  
ip address 10.1.1.1 255.255.255.0  
ip nat inside  
speed auto  
!  
interface FastEthernet0/0:1  
ip address 61.33.161.130 255.255.255.0  
encapsulation dot1Q 20  
ip nat outside  
!  
ip route 0.0.0.0 0.0.0.0 61.33.161.1  
ip route 0.0.0.0 0.0.0.0 200.212.149.1  
!  
access-list 1 permit 10.1.1.0 0.0.0.255  
!  
ip nat inside source list 1 interface FastEthernet0/0:1 overload  
!
```

Public IP (DHCP) + NAT/PAT

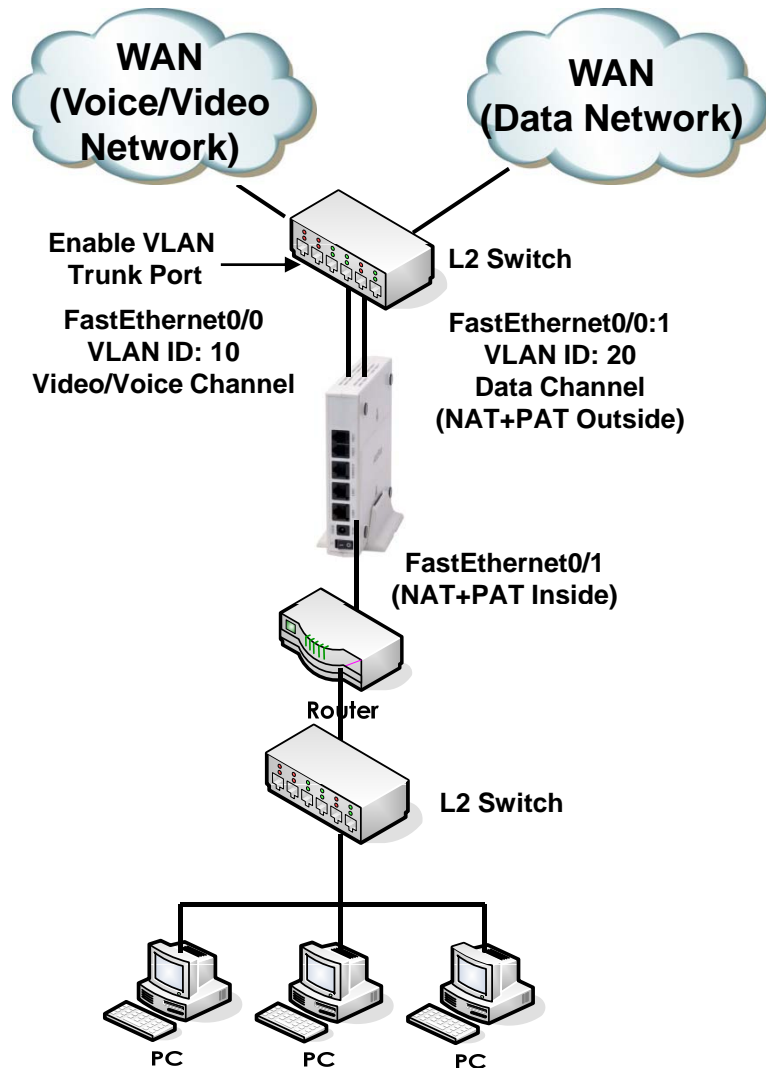

```
interface Loopback0
ip address 127.0.0.1 255.0.0.0
!
interface FastEthernet0/0
ip address dhcp
encapsulation dot1Q 10
speed auto
!
interface FastEthernet0/1
ip address 10.1.1.1 255.255.255.0
ip nat inside
speed auto
!
interface FastEthernet0/0:1
ip address dhcp
encapsulation dot1Q 20
ip nat outside
!
access-list 1 permit 10.1.1.0 0.0.0.255
!
ip nat inside source list 1 interface FastEthernet0/0:1 overload
```

Public IP (PPPoE) + NAT/PAT

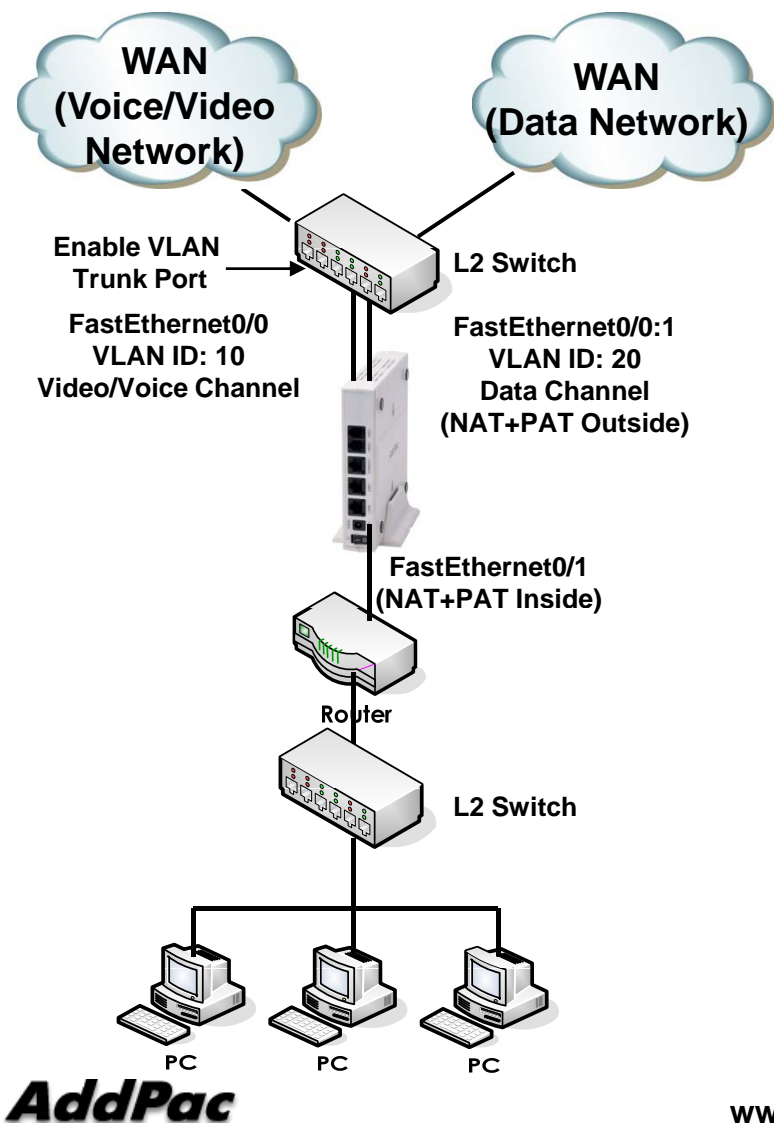

```

interface FastEthernet0/0
no ip address
encapsulation dot1Q 10
pppoe enable
encapsulation ppp
pppoe-client local-interface
ppp authentication pap callin
ppp pap sent-username test password test
speed auto
!
interface FastEthernet0/1
ip address 10.1.1.1 255.255.255.0
ip nat inside
speed auto
!
interface FastEthernet0/0:1
no ip address
encapsulation dot1Q 20
pppoe enable
encapsulation ppp
pppoe-client local-interface
ppp authentication pap callin
ppp pap sent-username test password test
ip nat outside
!
access-list 1 permit 10.1.1.0 0.0.0.255
!
ip nat inside source list 1 interface FastEthernet0/0:1 overload
    
```

802.1Q VLAN +802.1P CoS

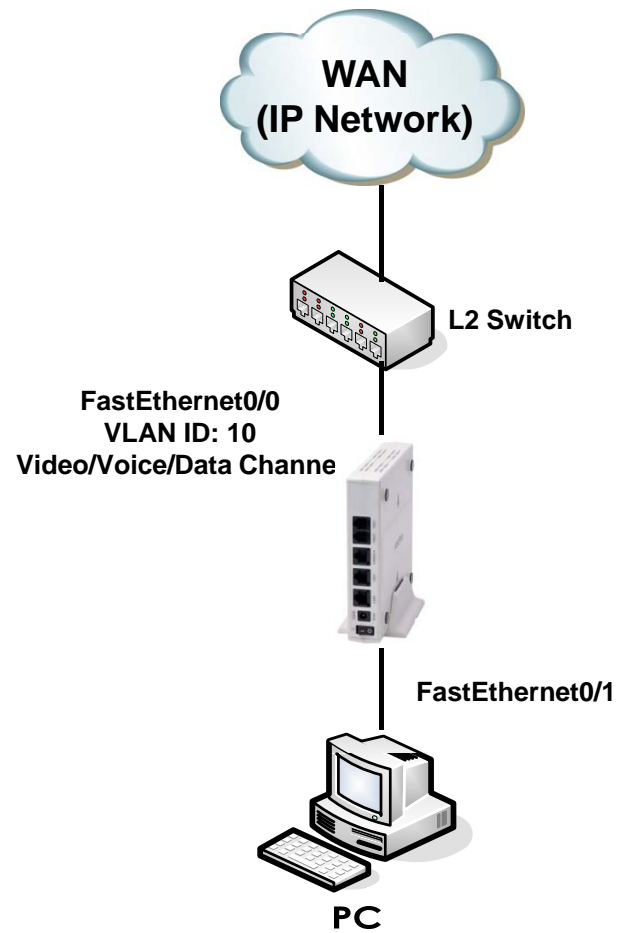

VLAN + CoS

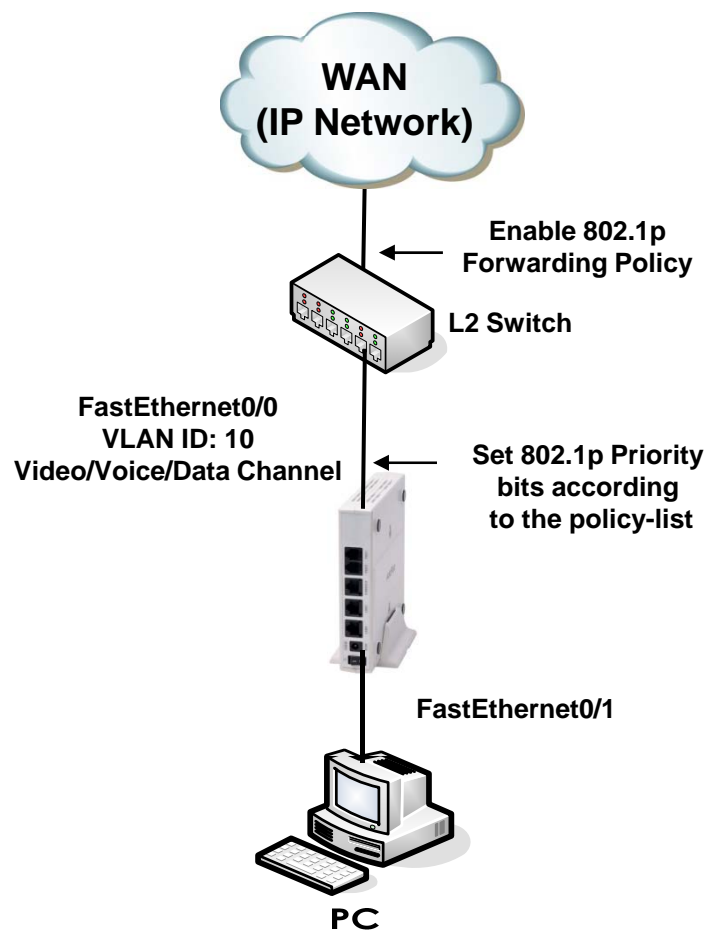

```
!  
interface Loopback0  
ip address 127.0.0.1 255.0.0.0  
!  
interface FastEthernet0/0  
ip address 200.212.149.130 255.255.255.0  
encapsulation dot1Q 10  
ip nat outside  
ip policy-group 1  
speed auto  
!  
interface FastEthernet0/1  
ip address 10.1.1.1 255.255.255.0  
ip nat inside  
speed auto  
!  
ip route 0.0.0.0 0.0.0.0 200.212.149.1  
!  
access-list 1 permit 10.1.1.0 0.0.0.255  
!  
ip policy-list 1 local signaling cos 7  
ip policy-list 1 local rtp cos 7  
ip policy-list 1 default cos 0  
!  
ip nat inside source list 1 interface FastEthernet0/0 overload  
!
```

802.1Q VLAN + Bridge

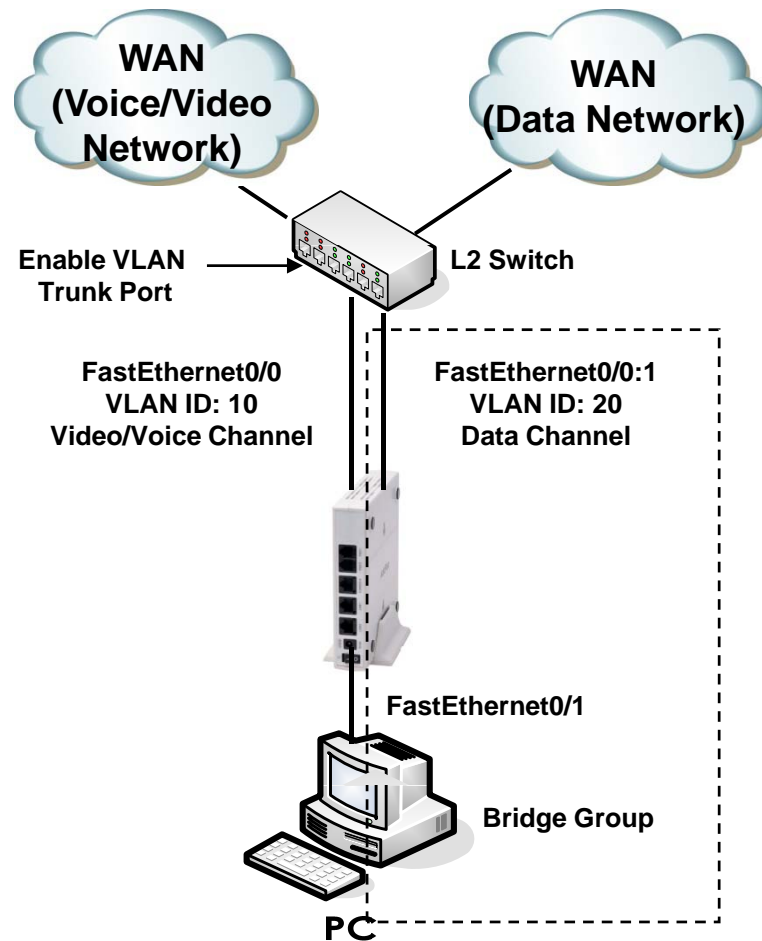

VLAN + Single Bridge Group

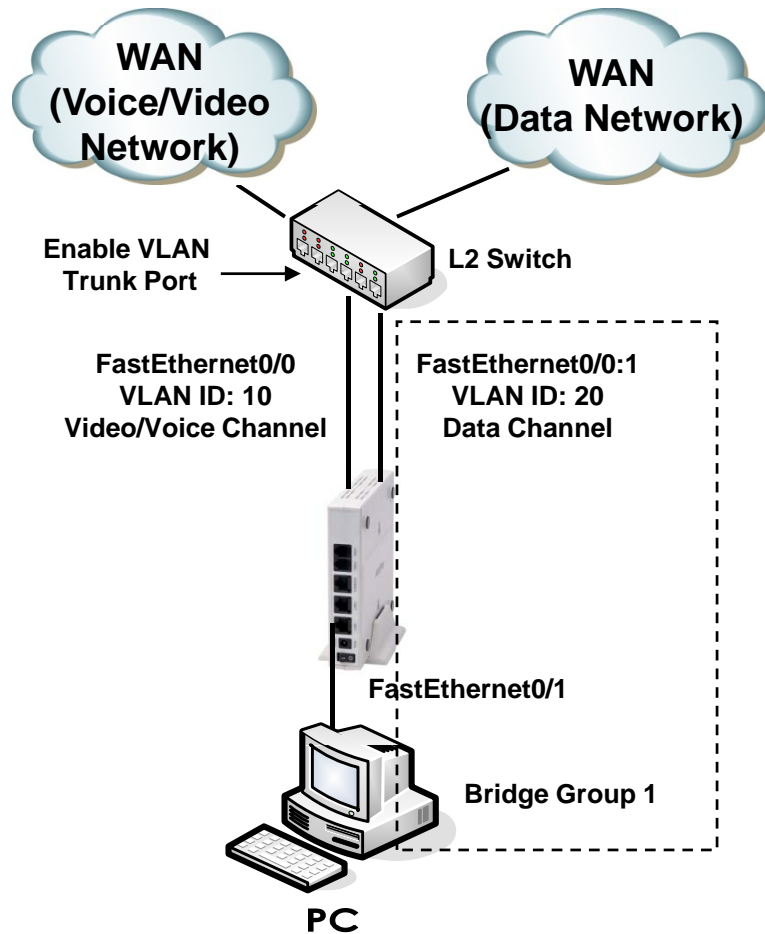

```
!  
interface Loopback0  
 ip address 127.0.0.1 255.0.0.0  
!  
interface FastEthernet0/0  
 ip address 200.212.149.130 255.255.255.0  
 encapsulation dot1Q 10  
 speed auto  
!  
interface FastEthernet0/1  
 no ip address  
 bridge-group 1  
 speed auto  
!  
interface FastEthernet0/0:1  
 no ip address  
 encapsulation dot1Q 20  
 bridge-group 1  
!  
no ip routing  
!  
ip route 0.0.0.0 0.0.0.0 200.212.149.1  
!  
!
```

VLAN + Double Bridge Group

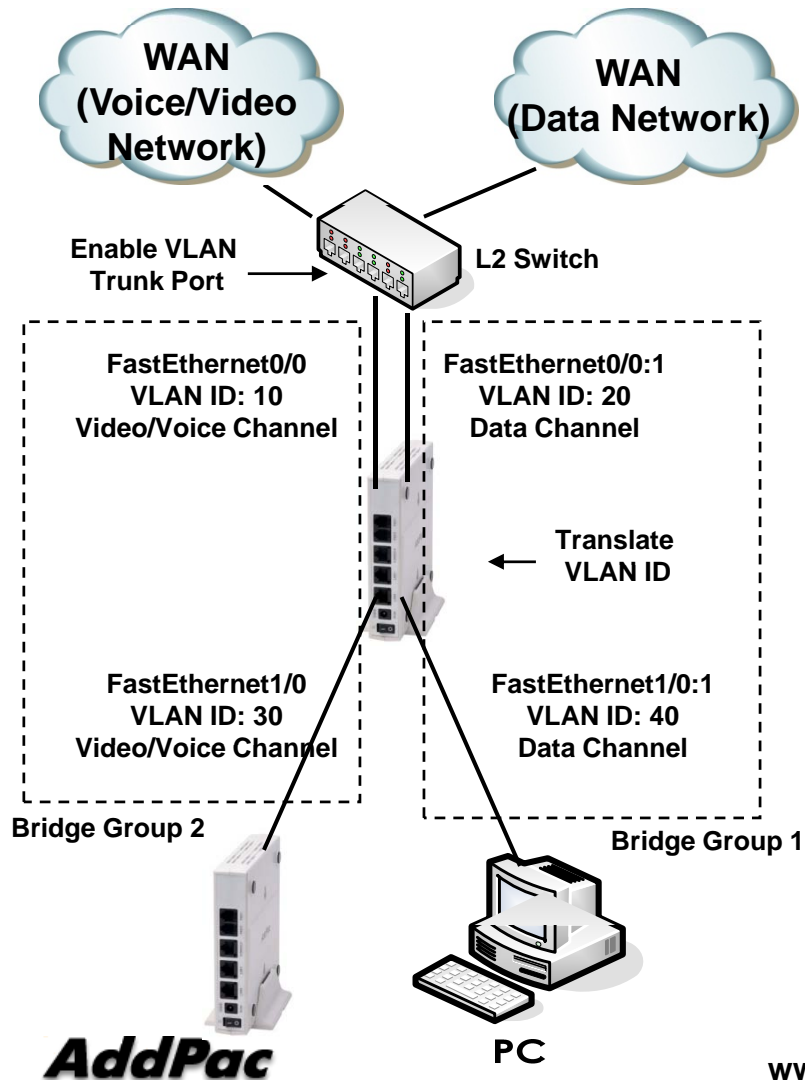

```
!  
interface FastEthernet0/0  
ip address 200.212.149.130 255.255.255.0  
encapsulation dot1Q 10  
bridge-group 2  
speed auto  
!  
interface FastEthernet0/1  
no ip address  
encapsulation dot1Q 30  
bridge-group 2  
speed auto  
!  
interface FastEthernet0/0:1  
no ip address  
encapsulation dot1Q 20  
bridge-group 1  
!  
interface FastEthernet1/0:1  
no ip address  
encapsulation dot1Q 40  
bridge-group 1  
!  
no ip routing  
!  
ip route 0.0.0.0 0.0.0.0 200.212.149.1  
!
```

VoIP Gateway Series

Thank you!

AddPac Technology Co., Ltd.
Sales and Marketing

Phone +82.2.568.3848 (KOREA)

FAX +82.2.568.3847 (KOREA)

E-mail sales@addpac.com