

AP-HVC2000

MCU Built-in Two(2)-Channel Full HD Video Conference Equipment

High Performance Full HD Video Conference Solution



Preliminary Product Overview

(Without notice, following described technical spec. can be changed)

AddPac

AddPac Technology

Sales and Marketing

www.addpac.com

Contents

- Product Overview
- Benefits and Features
- Hardware Specification
- AEC Microphone
- Multimedia Service
- Software Service
- Network Service and Features
- OSD Software Features
- Application Area
- Ordering Information



Product Overview

AP-HVC2000 MCU Built-in Two(2)-Channel Full HD Video Conference Codec

- IP based Video Conference Solution
- High-End Full HD Video Camera Features
- CMOS Sensor, 2Mega Pixel Camera
- Various Video Format Support (ex;1080i/59.94)
- PAN/TILT/Zoom Housing Features
- Optical 10 x Zoom, Digital 12 x Zoom Camera
- Built-in Wide Angle Lens for Video Conference
- Two(2) Channel Video Interface
- 4-Party Full HD MCU Built-in
- Second Video Interface for Document Sharing, Camera, etc
- External Acoustic Echo Canceller Microphone (AP-MP100)
- High-performance Video, Audio, and Voice Service
- Flexible Videoconferencing Deployment
- Firmware Upgradeable Architecture
- Video Solution with Outstanding Network Service Capability
- Audio/Video Privacy Protection

Product Highlights

AP-HVC2000 MCU Built-in Two(2)-Channel Full HD Video Conference Codec

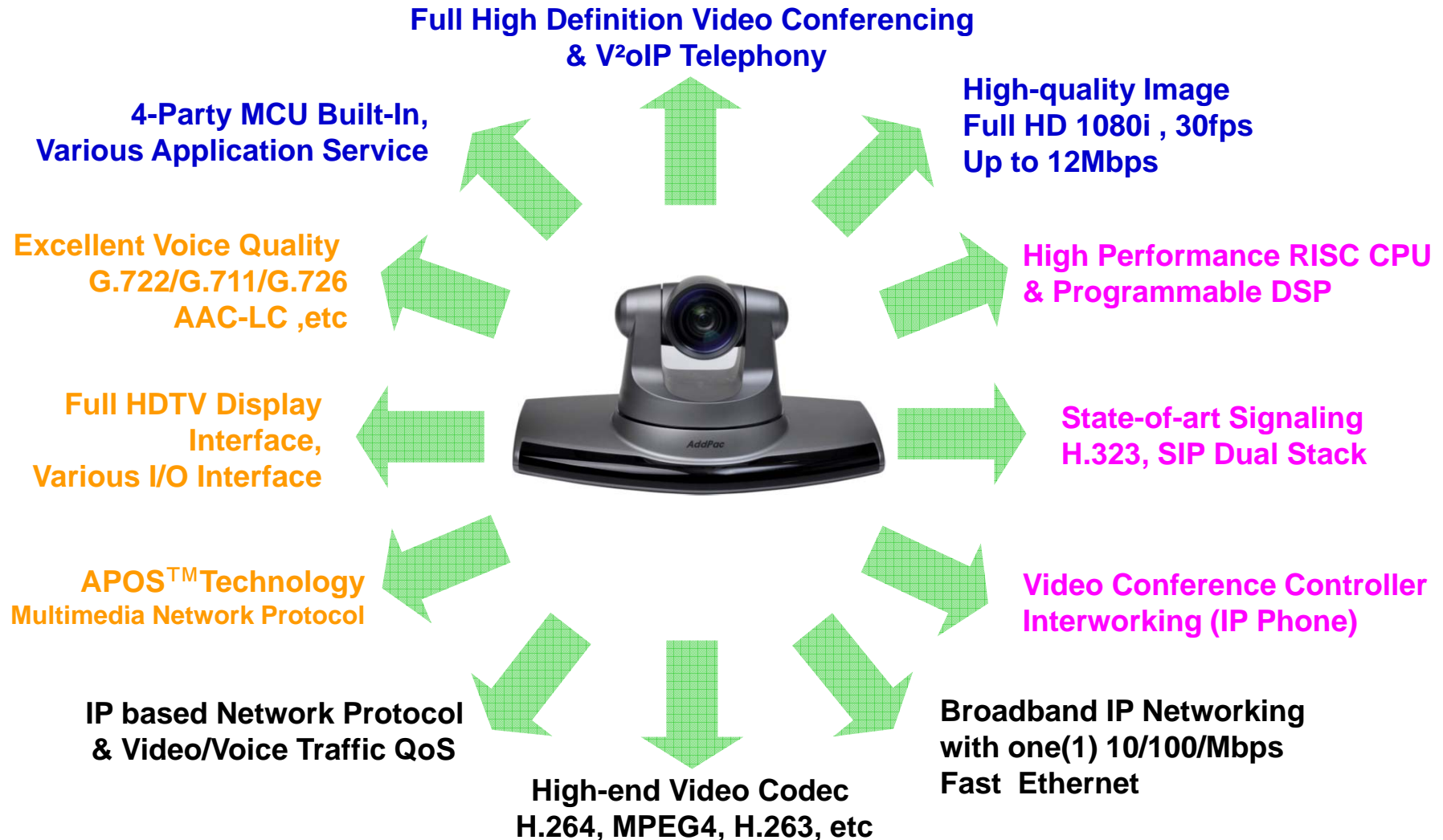

AddPac

www.addpac.com

Multimedia Service

AP-HVC2000 MCU Built-in Two(2)-Channel Full HD Video Conference Codec

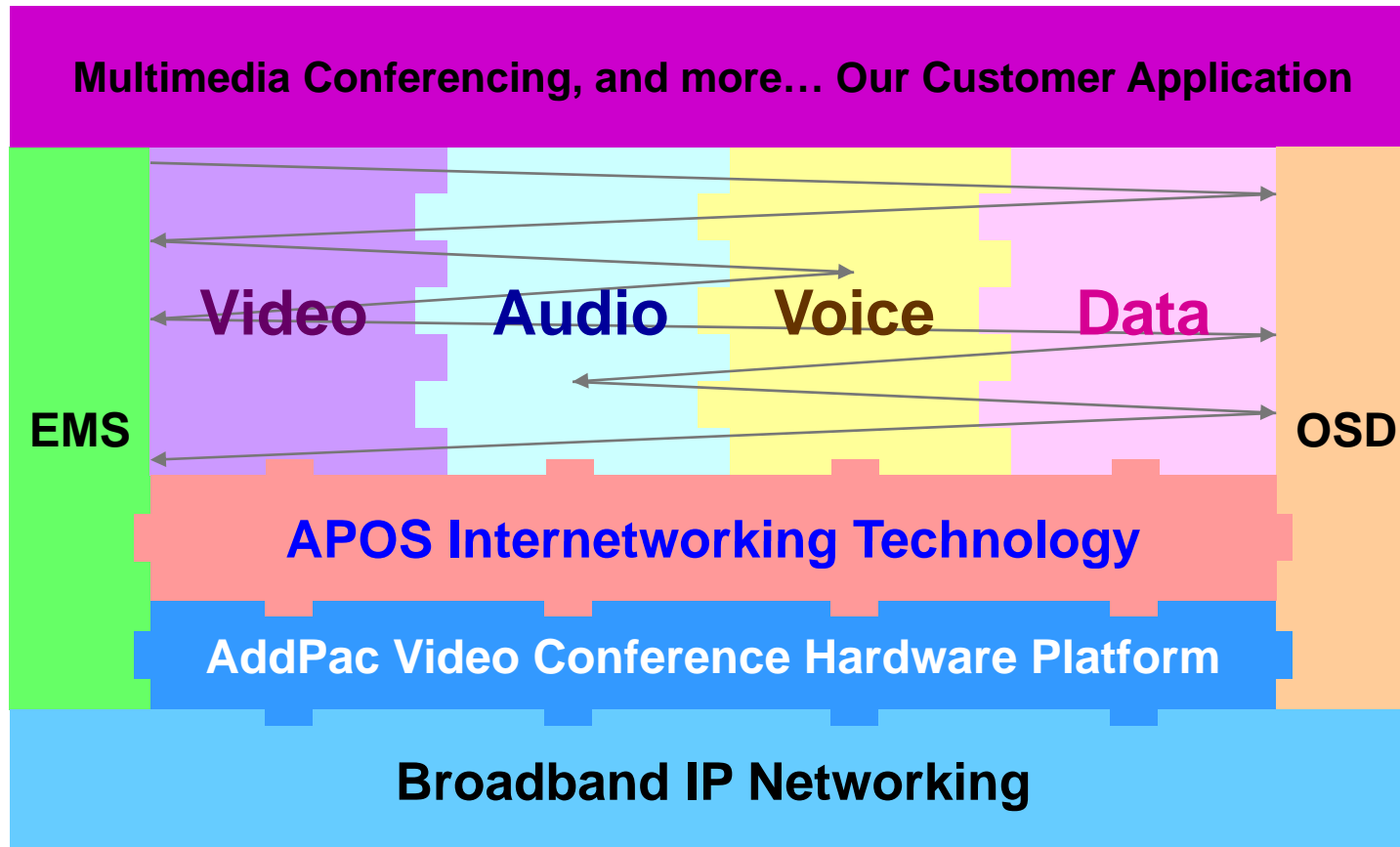

- APOS : AddPac Internetworking Operating System
- OSD : On- Screen Display
- EMS : Element Management System

Benefits and Features

AP-HVC2000 MCU Built-in Two(2)-Channel Full HD Video Conference Codec

- Various Video Input/Output Interface
 - Composite (RCA) , Component (Y, Pb, Pr), HDMI
- High-performance Video Codec Support
 - H.264, MPEG4, H.263, etc
- Powerful Image Resolution Support
 - CIF(352x288), QVGA(320x240), HVGA(640x240), VGA(640x480), 4CIF(704x576), 720P(1280x720), 1080i(1920x1080)
- Up to 30fps with Full HD-Resolution(H.264)
- 4-Party Full HD MCU Built-In
- SIP, H.323 Signaling Support
- Rate Control for Video Traffic QoS
 - Ensuring Optimized Quality
 - Frame Rate with Limited Bandwidth
- High-end Error Resilient Against Various Packet Error



Hardware Specification (AP-HVC2000 Full HD Codec)

Hardware Specification

High-end
DSP

AP-HVC2000 MCU Built-in Two(2)-Channel Full HD Video Conference Codec

- High Performance RISC Computing Power
- High-end Programmable DSP Hardware Architecture
- CH#1 I/O Interface

Video Input	Built-in Full HD Camera
Video Output	Composite RCA, Component , HDMI
Audio Input	Stereo RCA Type Audio Input
Audio Output	RCA Type Audio Output (Left, Right)

- CH#2 I/O Interface

Video Input	Composite RCA, HD-SDI, RGB, HDMI
Video Output	Composite RCA, Component , HDMI
Audio Input	Stereo RCA Type Audio Input
Audio Output	RCA Type Audio Output (Left, Right)
PTZ Control	RS-232C Pan/Tilt/Zoom Control Interface

Hardware Specification

High-end
DSP

AP-HVC2000 MCU Built-in Two(2)-Channel Full HD Video Conference Codec

- High-end Programmable DSP Hardware Architecture
- Network Interface
 - One(1) 10/100Mbps Fast Ethernet(RJ45)
 - One(1) RS-232C Interface (RJ45) for Console
- USB Interface
 - USB 2.0 Interface for Mouse, etc
- Voice Interface
 - FXS Interface for Analog Phone, Analog Conference Phone, etc
- External Power Input Connector
- Power On/Off Switch

Hardware Specification

High-end
DSP

AP-HVC2000 MCU Built-in Two(2)-Channel Full HD Video Conference Codec

- Full HD Camera Specification
 - High-end CMOS Camera Sensor
 - 2Mega Pixel
 - HD : 1080i/59.94, 1080i/50, 720p/59.94, 720p/50, etc
 - Auto Focus 10 x Optical Zoom, 12 x Digital Zoom
 - Wide Angle Lens for Video Conference Application
 - PELCO-D Control Protocol
 - Position Preset

Hardware Specification

High-end
DSP

AP-HVC2000 MCU Built-in Two(2)-Channel Full HD Video Conference Codec



Hardware Specification

High-end
DSP

AP-HVC2000 MCU Built-in Two(2)-Channel Full HD Video Conference Codec

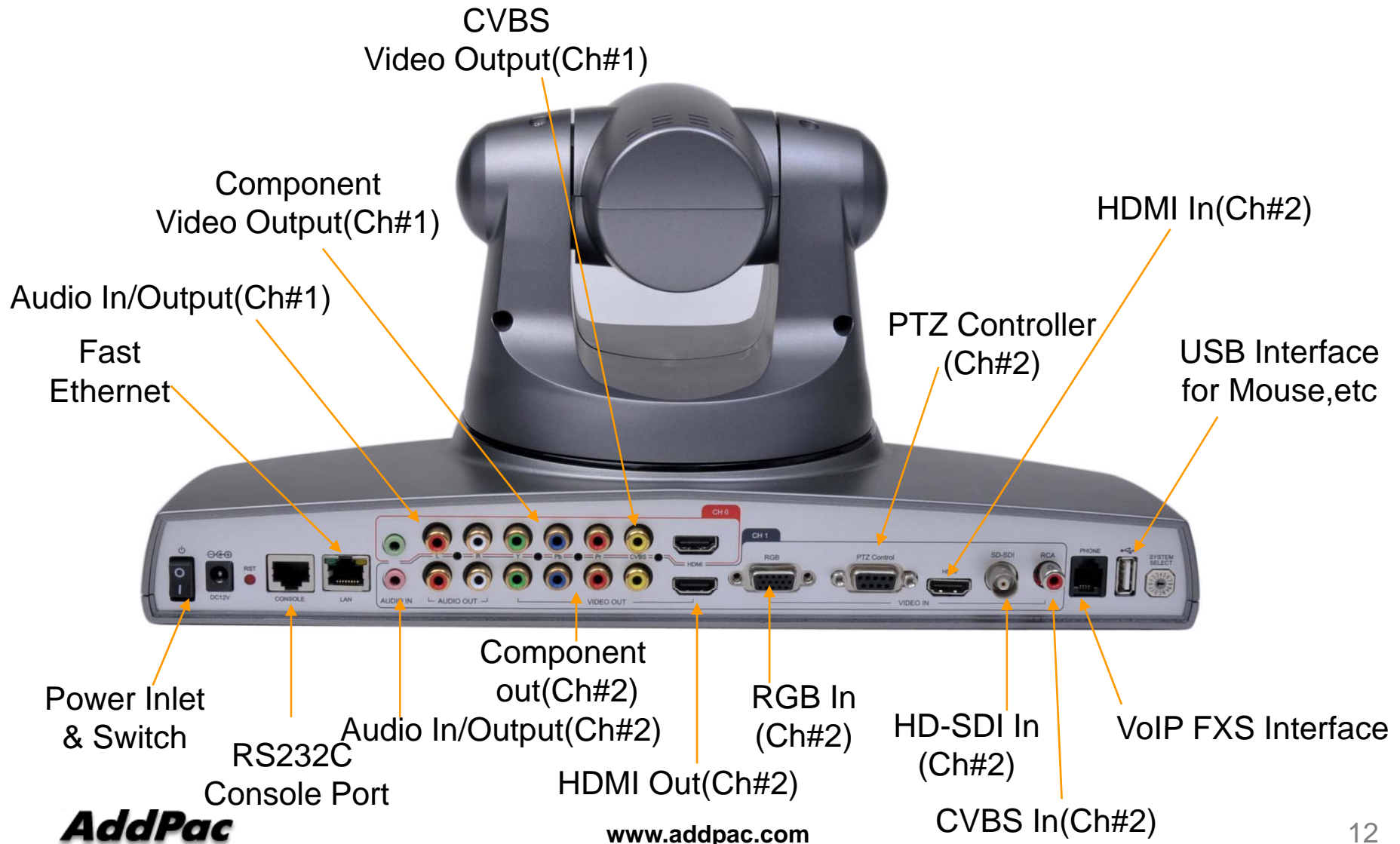

Software Service

AP-HVC2000 MCU Built-in Two(2)-Channel Full HD Video Conference Codec

- Built-in APOS Internetworking Software
 - Scalability, Functionality, and Stability Features
 - Video Traffic QoS Control
- Programmable Video, Audio, and Voice Services
 - Video Codes, Audio, and Voice Codec
- High Performance VoIP Signaling
 - SIP, H.323 VoIP Signaling
- 4-Party Full HD MCU Signaling
- Firmware Upgradeable Architecture
- OSD (On-screen Display) Function Support
- Industry Standard IP based Network Protocol Features

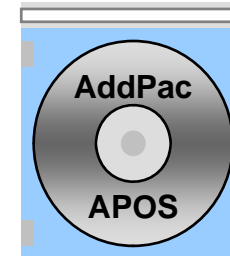



4-Party MCU Features (AP-HVC2000 Full HD Codec)

MCU Service and Features (cont..)

AP-HVC2000 MCU Built-in Two(2)-Channel Full HD Video Conference Codec

- Simplified AV Mixing Model
- Video Codec : H.264, MPEG4, H.263, etc
- Voice Codec : G.722, G.711, G.729, etc
- Asymmetric Rate Control between Encoder & Decoder
- Same Conference Layout for All Party

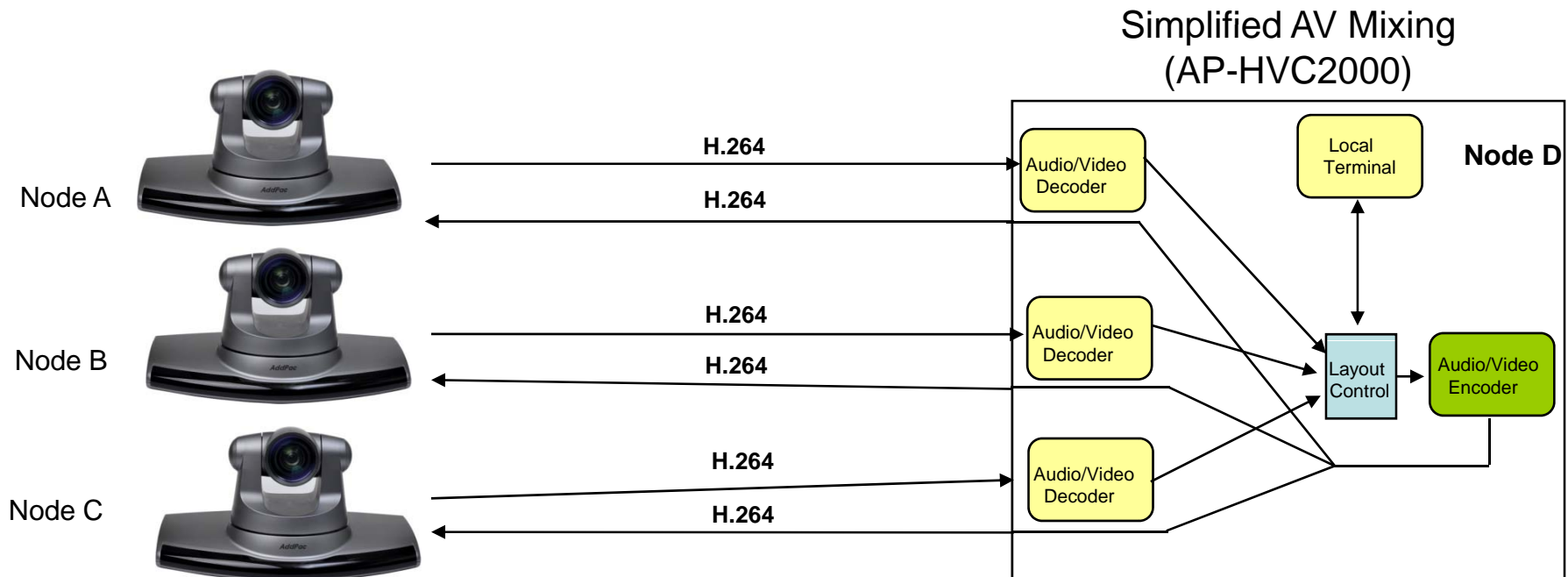

MCU Service and Features (cont..)

AP-HVC2000 MCU Built-in Two(2)-Channel Full HD Video Conference Codec

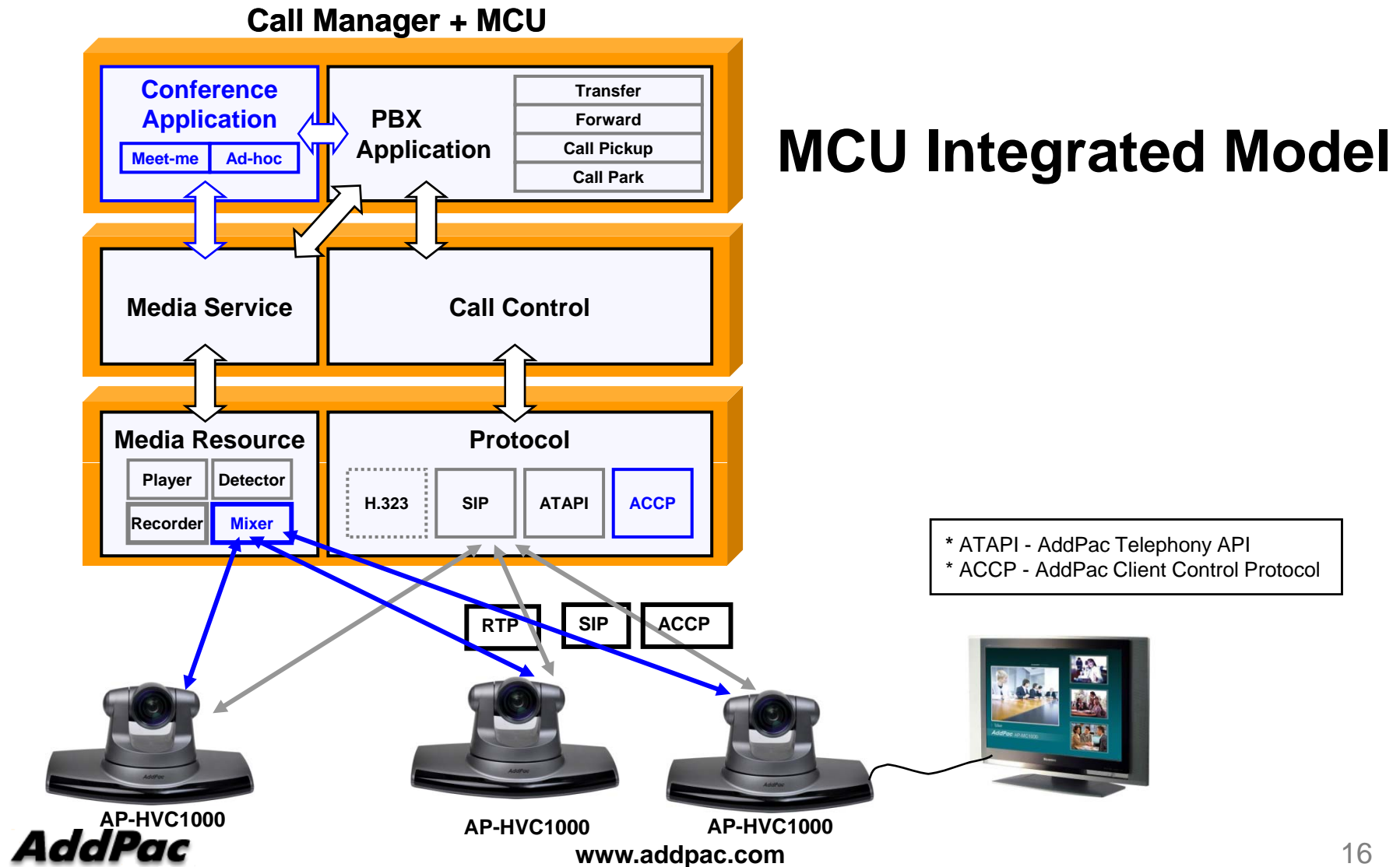

MCU Service and Features (cont..)

AP-HVC2000 MCU Built-in Two(2)-Channel Full HD Video Conference Codec

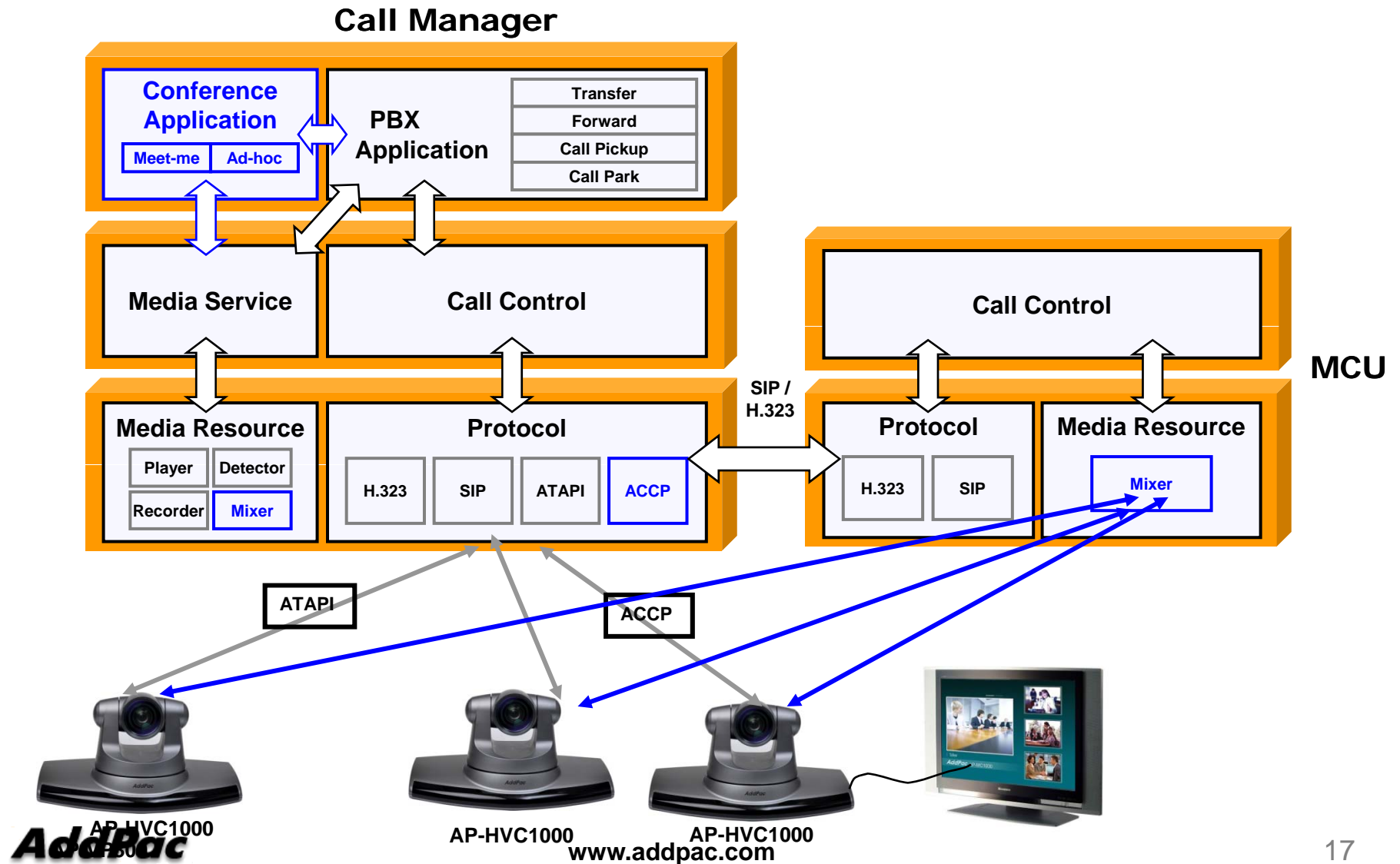

MCU Service and Features (cont..)

AP-HCC2000 Two(2)-Channel Full HD Video Conference Codec

- Type of Conference
 - Meet-Me (Dial-In) Conference
 - Require that a *range of directory numbers* be allocated for exclusive use of the conference
 - Ad Hoc (On-Demand) Conference
 - using Conference and Join soft key
 - Dial-Out Conference
- View Mode Configuration

Network Service and Features

AP-HVC2000 MCU Built-in Two(2)-Channel Full HD Video Conference Codec

- **Basic Routing**
 - Static Routing (IPv4)
 - Static / DHCP / PPPoE
 - VRRP (Virtual Redundancy Routing Protocol)
- **Network Management**
 - SNMPv2/SNMPv3 Support
 - Standard & Enterprise SNMP MIB Support
 - Web Based Management using HTTP/HTTPS
 - Console / Telnet / Rlogin / SSH Interface
- **Security Function**
 - Standard & Extended IP Access List
 - HTTPS / SSH Interface
 - Auto-disconnect Telnet/Console Session
 - Access Control for Local Service (FTP/Telnet/HTTP.)
 - Enable/Disable Network Services
 - Multi-Level User Account Management

Network Service and Features

AP-HVC2000 MCU Built-in Two(2)-Channel Full HD Video Conference Codec

- Operation & Management
 - Configuration Backup & Restore for APOS Managements
 - Use Multiple APOS™ and Configuration
 - Auto Upgrade via HTTP/HTTPS
 - Debugging, System Auditing, and Diagnostics Support
 - FTP/TFTP/Telnet/SSH Server and Client
 - HTTP Server
 - Remote logging using Syslog
 - Local System Logging (Local HDD model)
 - RADIUS Authentication / Account
- Other Scalability Features
 - Network time Protocol (NTP) Support
 - Cisco Style Command Line Interface (CLI)
 - DHCP Server & Relay Functions
 - DNS Server



OSD Software Overview

Contents

- Menu Control Mode
- Dial Mode
- Conversation View Mode
- Display Layout Call Mode
- Key Pad Mode for Dialing Number
- Phone Book OSD
- Phone Book : New Contact
- Recent Call OSD
- Tools OSD Mode
- Codec Configuration : IP address, etc
- Status Bars OSD
- PTZ Control OSD

Menu Control Mode

Keypad, Phonebook, Recent Call, PTZ Control, Tools, Layout, Configuration



Menu Bar Indication
ICON

Function Key List
for Soft-key

Dialing OSD



Conversation View Mode



Remote Site View

PIP : Local Site View

Conversation View Mode



Remote Site Full Screen View

Display Layout Control Mode



Keypad Menu for Dialing Number



Phone Book OSD Menu

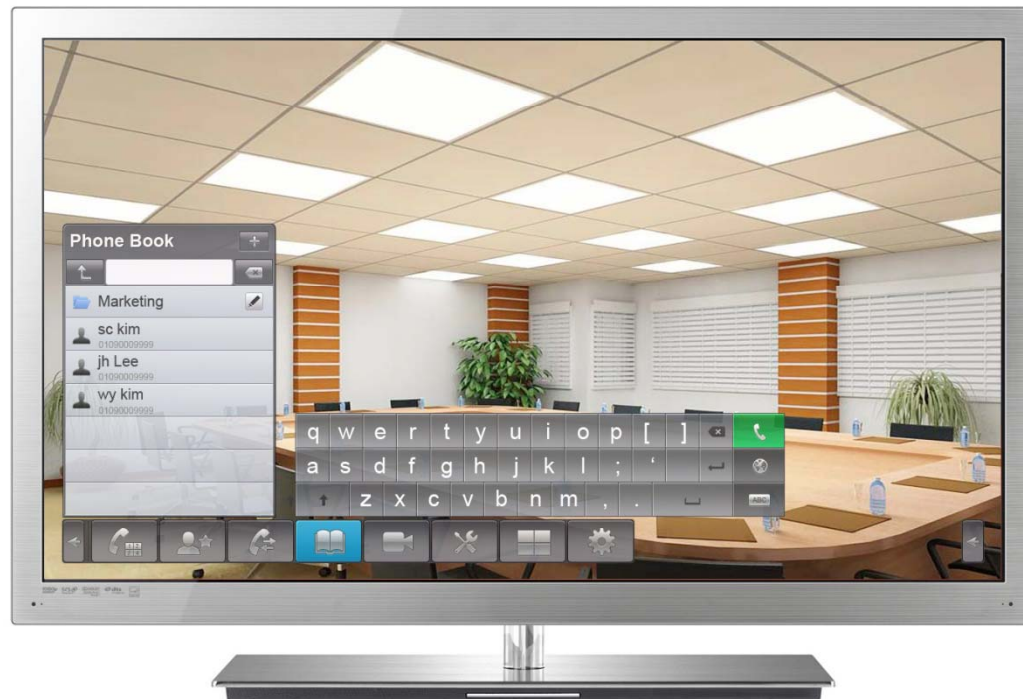

Phone Book OSD Menu : New Contact



Recent Call OSD Menu

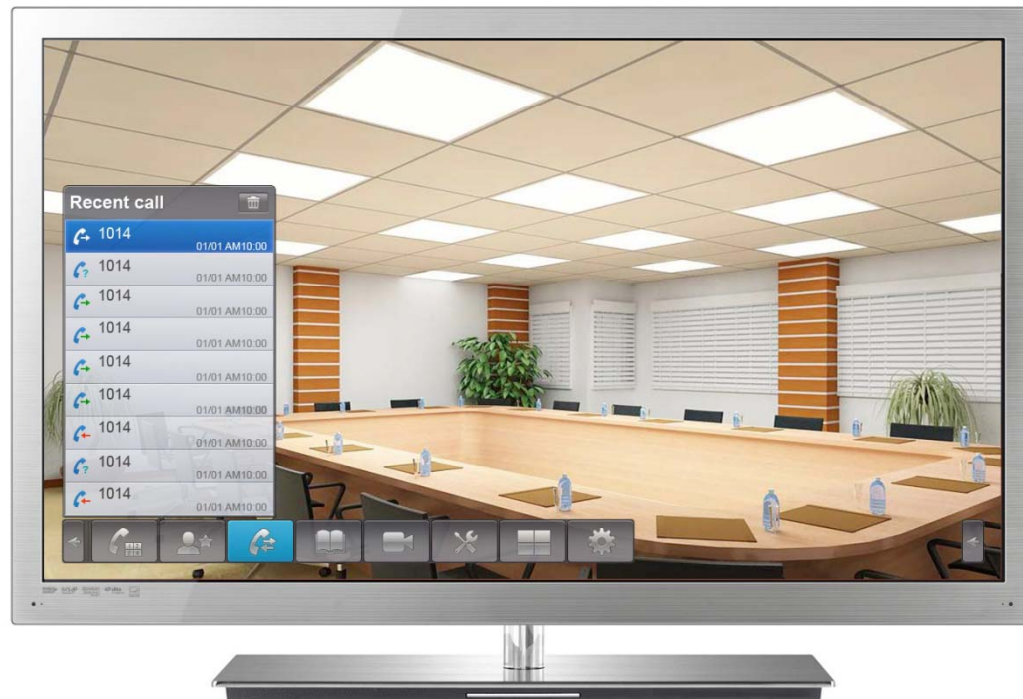

Tools OSD Menu



Codec Configuration



Status Indication Bars OSD

Status Bars



PTZ Control : Camera #1



PTZ Control : Camera Select



PTZ Control : Preset Setting



AP-HVC2000 Full HD Video Conference Equipment

Application Area

- Audio/Video Real-time Broadcasting
- Video Telephony
- Video Telephony + Document Broadcasting
- Video Telephony + Video Broadcasting
- Video Conference



Audio/Video Real-time Broadcasting

AP-HVC1000 Two(2)-Channel Full HD Video Conference Equipment

Audio and Video Broadcasting Service via Multicasting
IP Network
(Video, Audio/Voice, and more...)

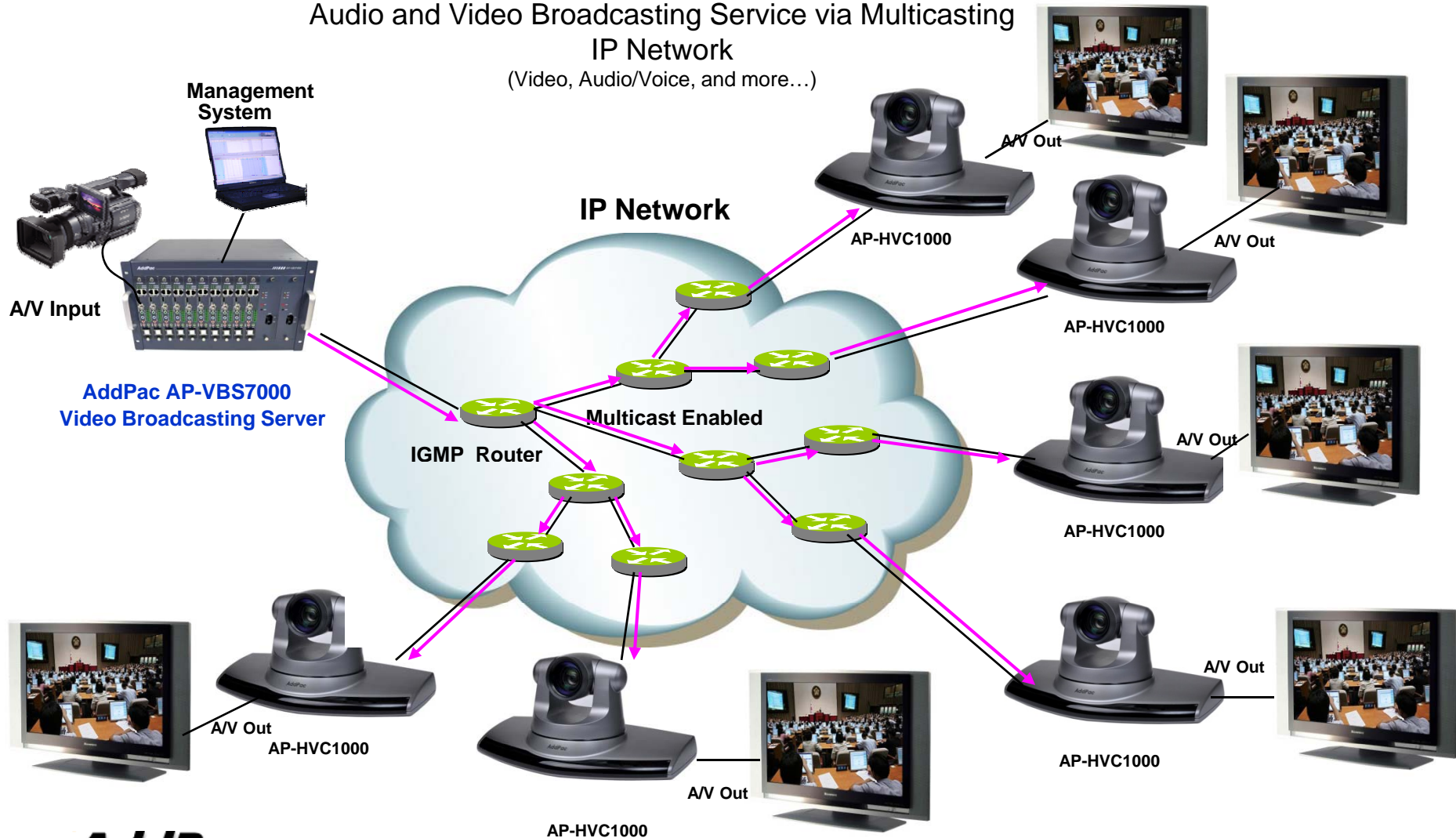

Video Telephony Application

H.264, 1080i, 30frame

H.264, 1080i, 30frame

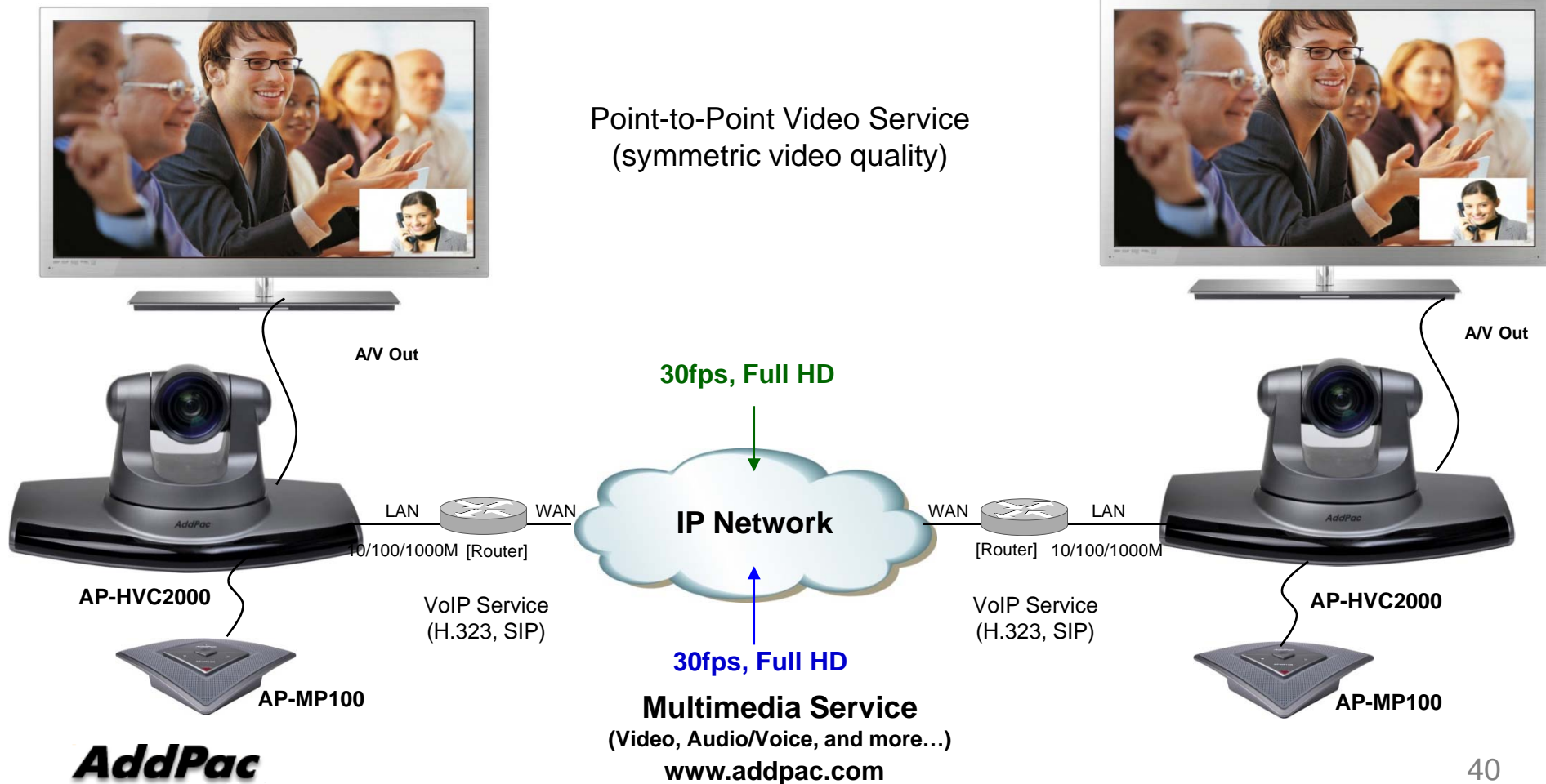

Video Telephony + Document Broadcasting

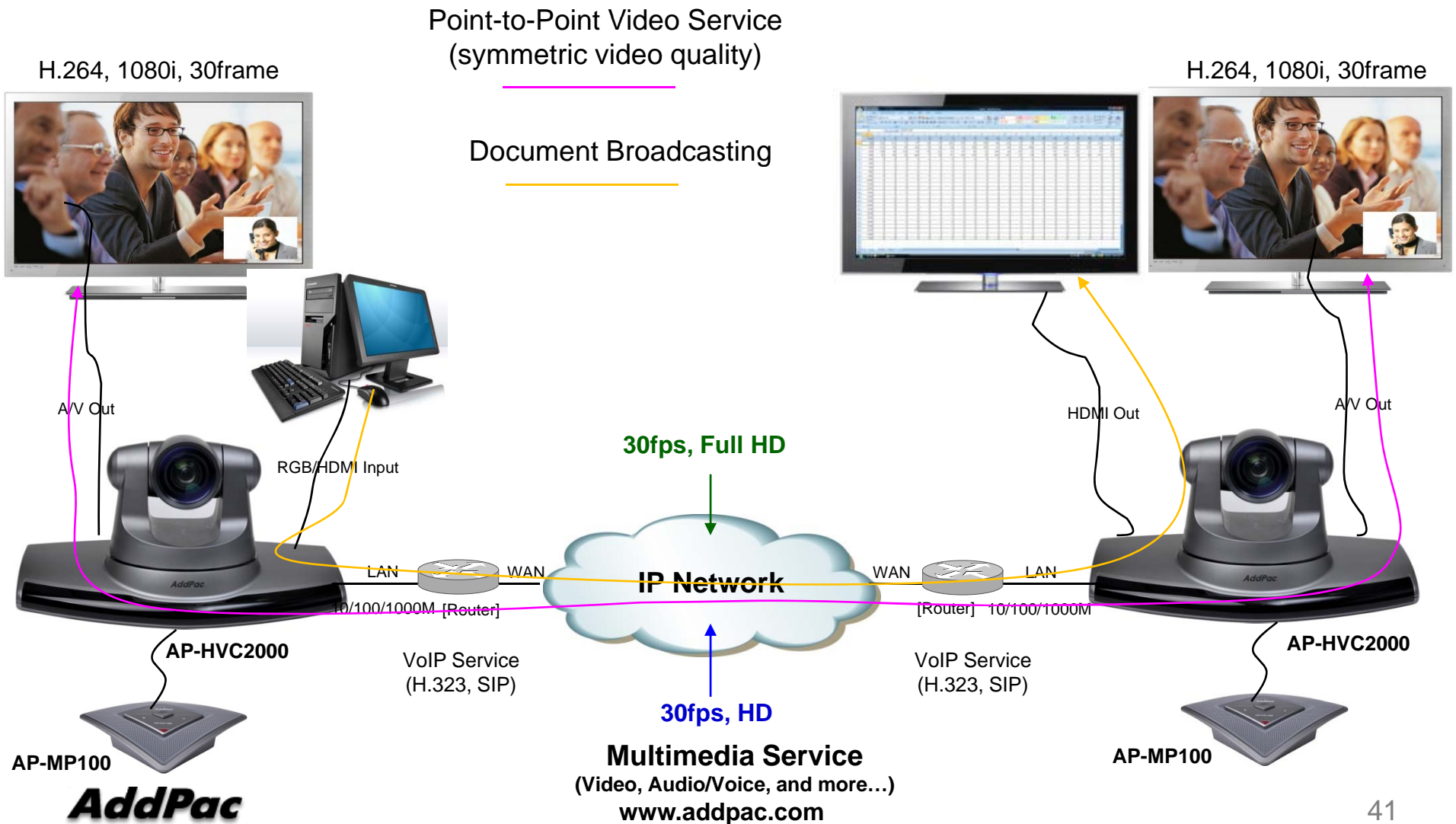

Video Telephony + Video Broadcasting

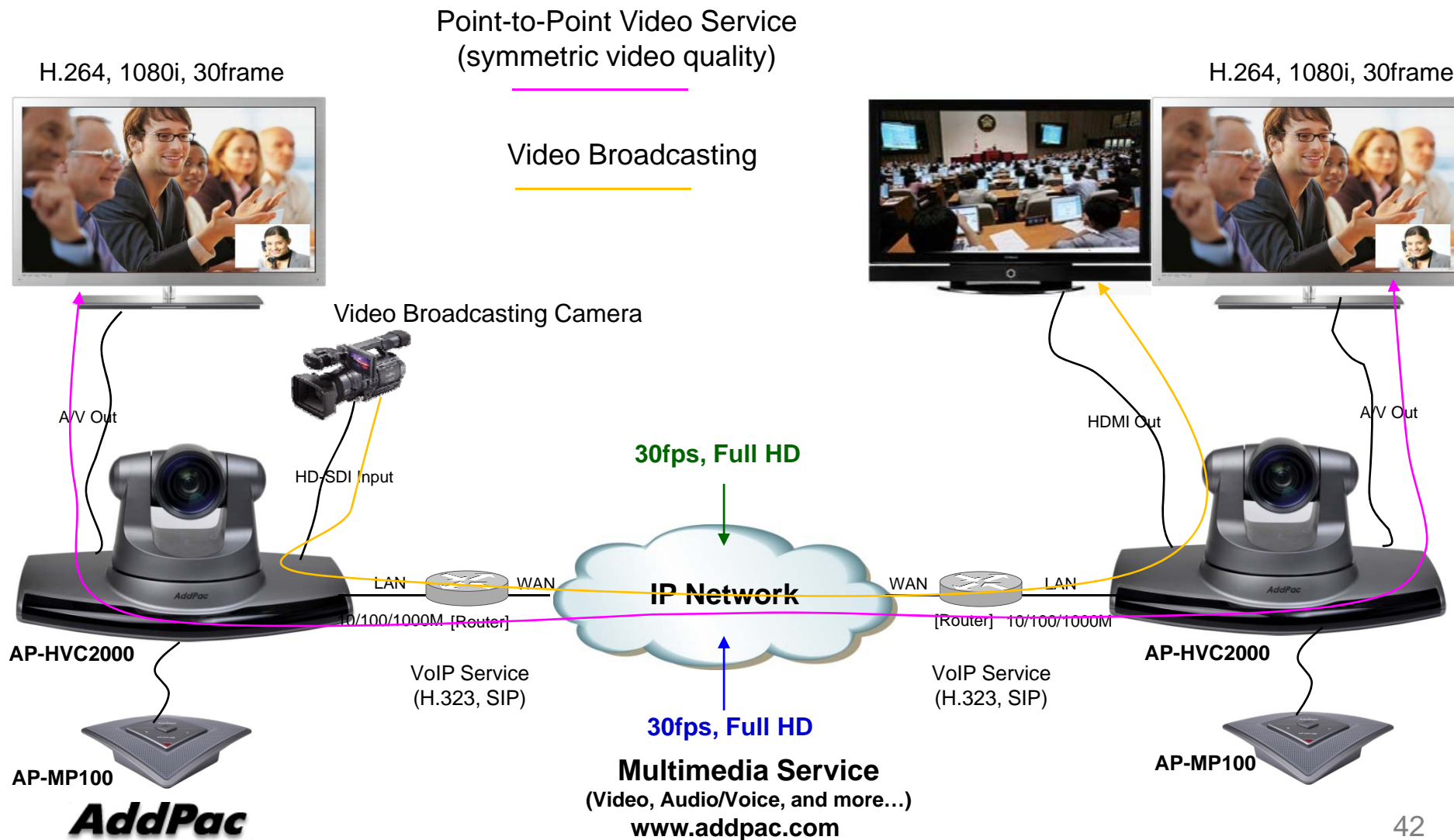

Video Conference

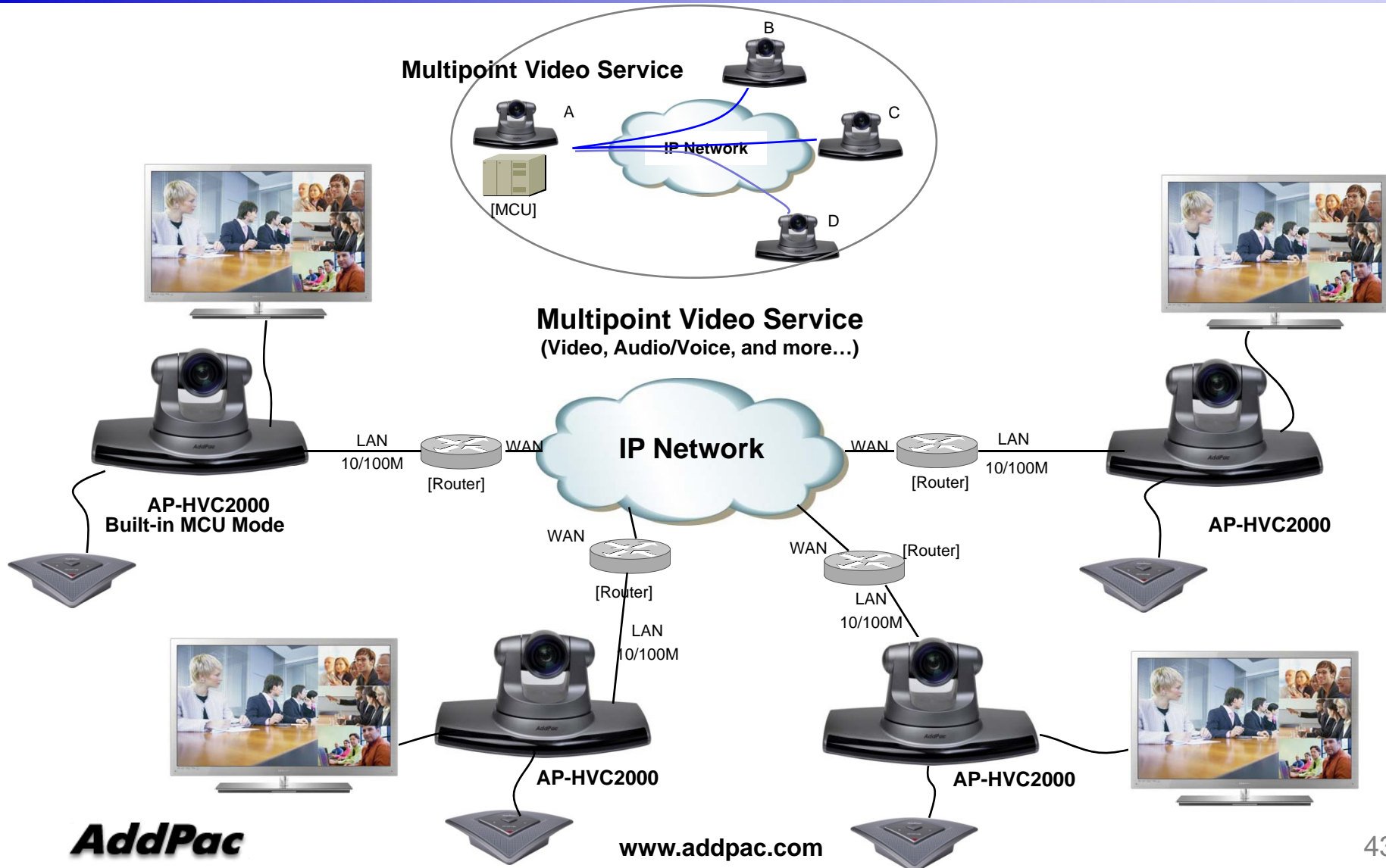

Ordering Information

- AP-HVC2000 Two(2) Channel Full HD Video Conference Equipment
 - AP-HVC2000 MCU Built-In Full HD Video Conference Equipment
 - Including Network Cable Set & Power Supply Cable, etc.
 - Option : Microphone
- Built-in APOS Internetworking Software for AP-HVC2000
- Including 1 Year Hardware Warranty
- Product Documents
 - Install and Operation Guide (PDF)
- Pricing
 - AddPac Technology Regional Sales Manager
 - Authorized Sales and Marketing Representatives
 - Please Contact www.addpac.com



Thank you!

AddPac Technology Co., Ltd.
Sales and Marketing

Phone +82.2.568.3848 (KOREA)

FAX +82.2.568.3847 (KOREA)

E-mail sales@addpac.com