



VoIP

AP2120

VoIP
Gateway



Technical Sales and Marketing

AddPac Technology

www.addpac.com

AddPac VoIP Products Road-Map

Multi-services Specific

Application Specific

1/2/4/8/16~60-Ports Voice



AP3100 VoIP Gateway



AP2120 VoIP Gateway



AP100x/1100 VoIP G/W Series

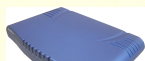

AP300 VoIP G/W Series



AP200 VoIP G/W Series



AP160 VoIP Gateway

Voice over IP Solutions

4/8/16, 30~120-Ports Voice



AP2850 Multi-service Router



AP2830 Multi-service Router



AP2520S Secure VoIP Gateway



AP2520R VoIP Router



AP2520G VoIP Gateway



AP2110 VoIP Gateway

VoIP Network Management SW



AP-VPMS S/W Solution

Voice & FAX Broadcasting System



AP3120 Voice Broadcasting System



AP3220 FAX Broadcasting System



AP1601 Voice Broadcasting Terminal

General Purpose VoIP Networking

VoIP & Data Networking

IP Application Solutions

AP2120 VoIP Gateway Product Overview

APOS Internetworking Protocol Stack

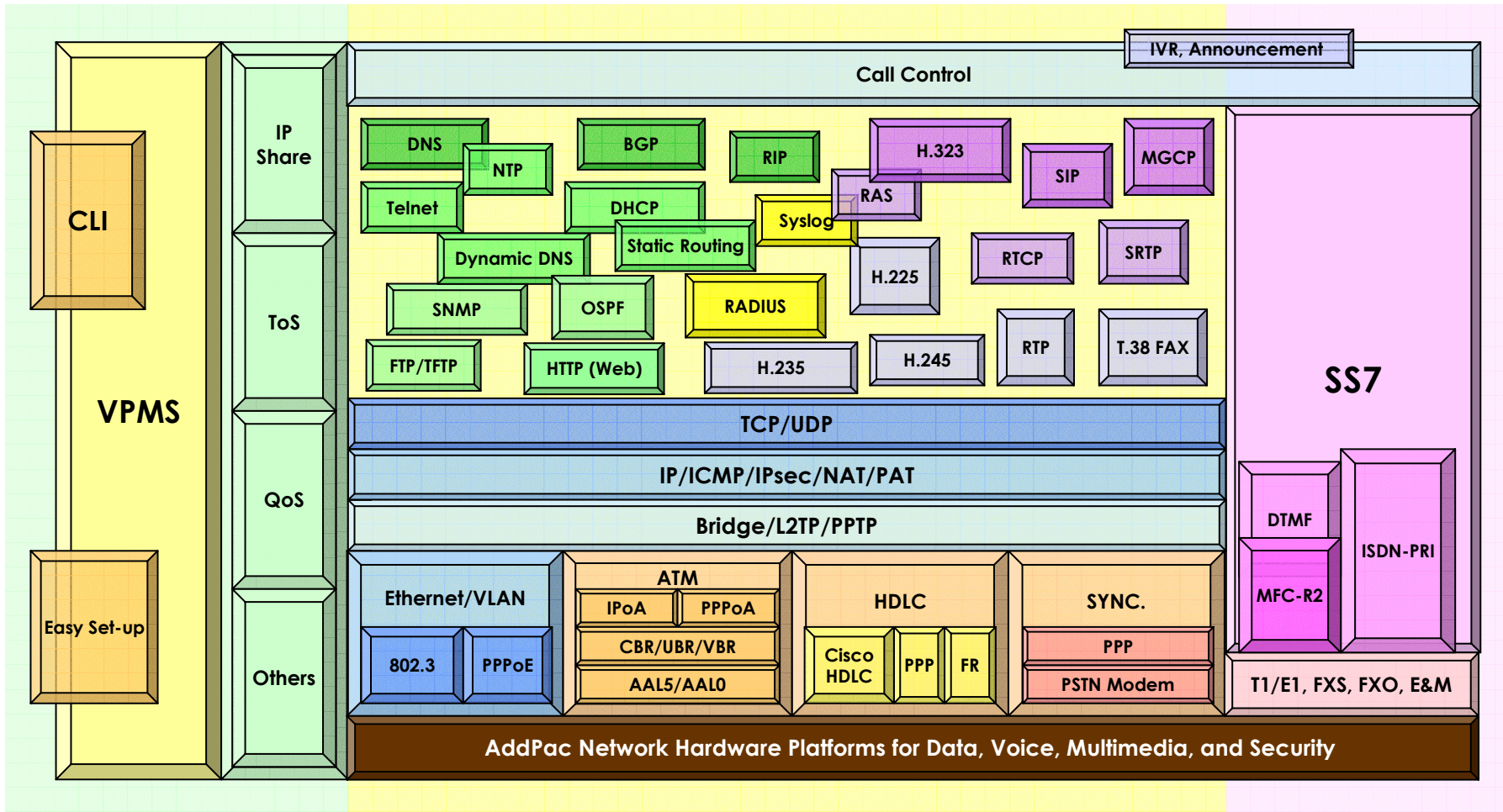

AP2120 VoIP Gateway Product Overview

APOS Internetworking S/W World

- APOS Internetworking Software World

- AddPac Operating System (APOS)
- Support Industry Standard
- Integrated Networking Protocols
- Optimized Performance & Functionality
- Easy to use, Installation, and Maintenance

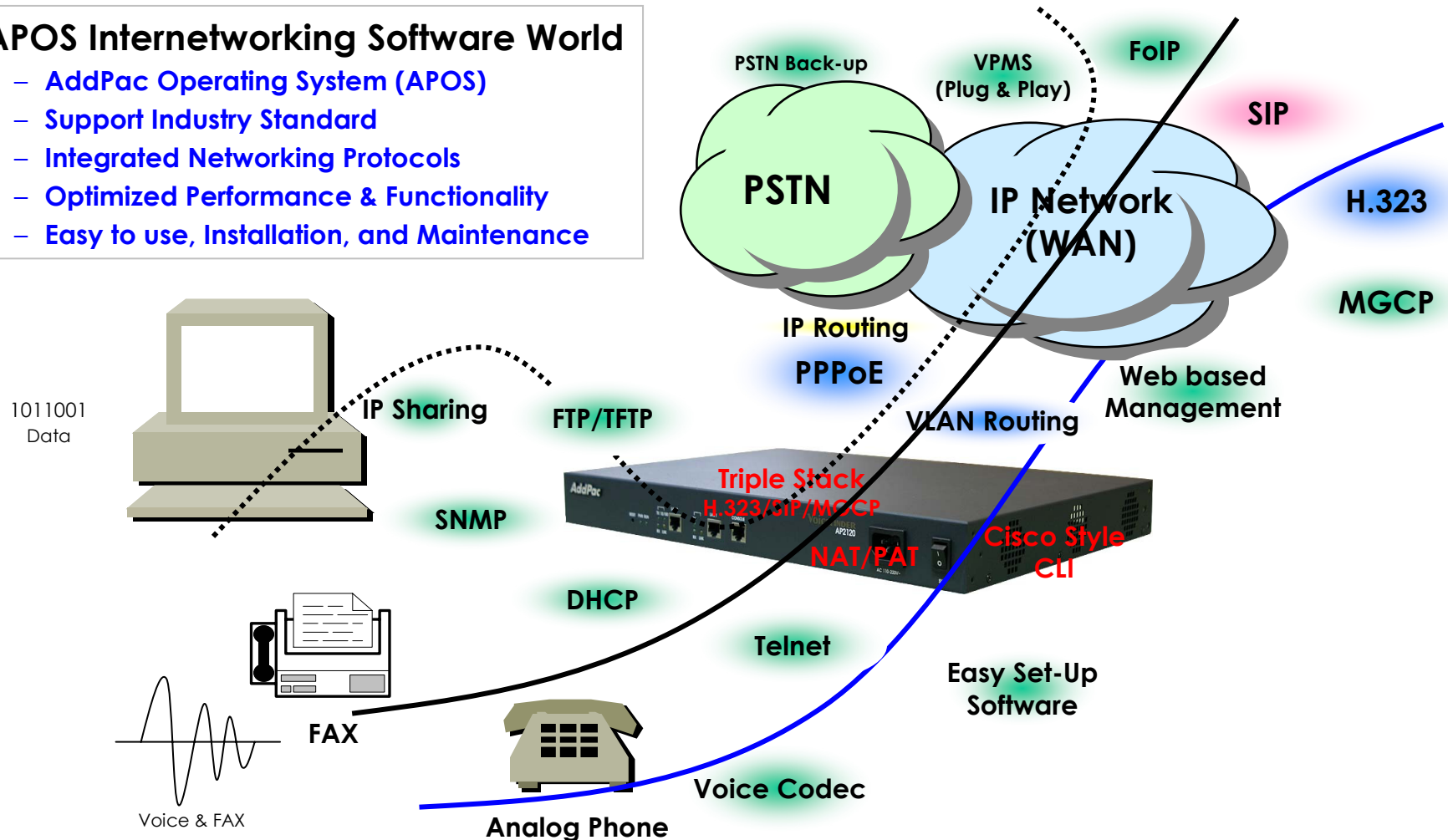

AP2120 VoIP Gateway Product Overview

APOS Internetworking S/W World (cont.)

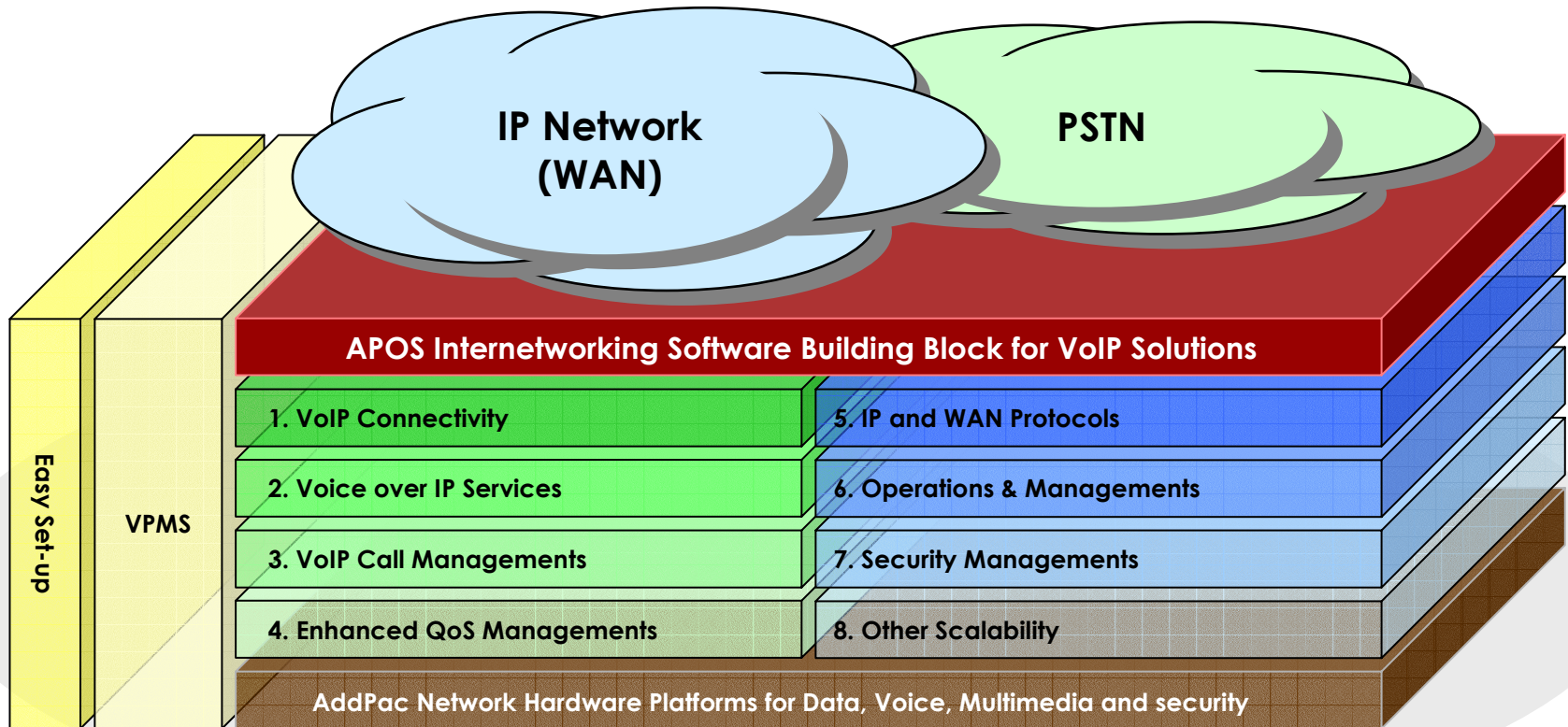

AP2120 VoIP Gateway Product Overview

VoIP Gateway Connectivity

• FXS

- RJ-11 Hardware interface
- Polarity inverse generation function
- Caller-id generation function
- Busy-out function support
- Ring cadence setting function
- Ring frequency setting function
- European type II telephone support
- Surge protect support

• FXO

- RJ-11 Hardware interface
- Polarity inverse detection function
- Caller-ID detection function
- Busy-out function support
- PSTN backup or busy-out function with Hook off in case of power down
- Clear down tone registration and detect function
- Hook flash timing setting function
- Ring detect timeout setting function
- Ring number setting function
- For outbound calls, connect when voice is detected

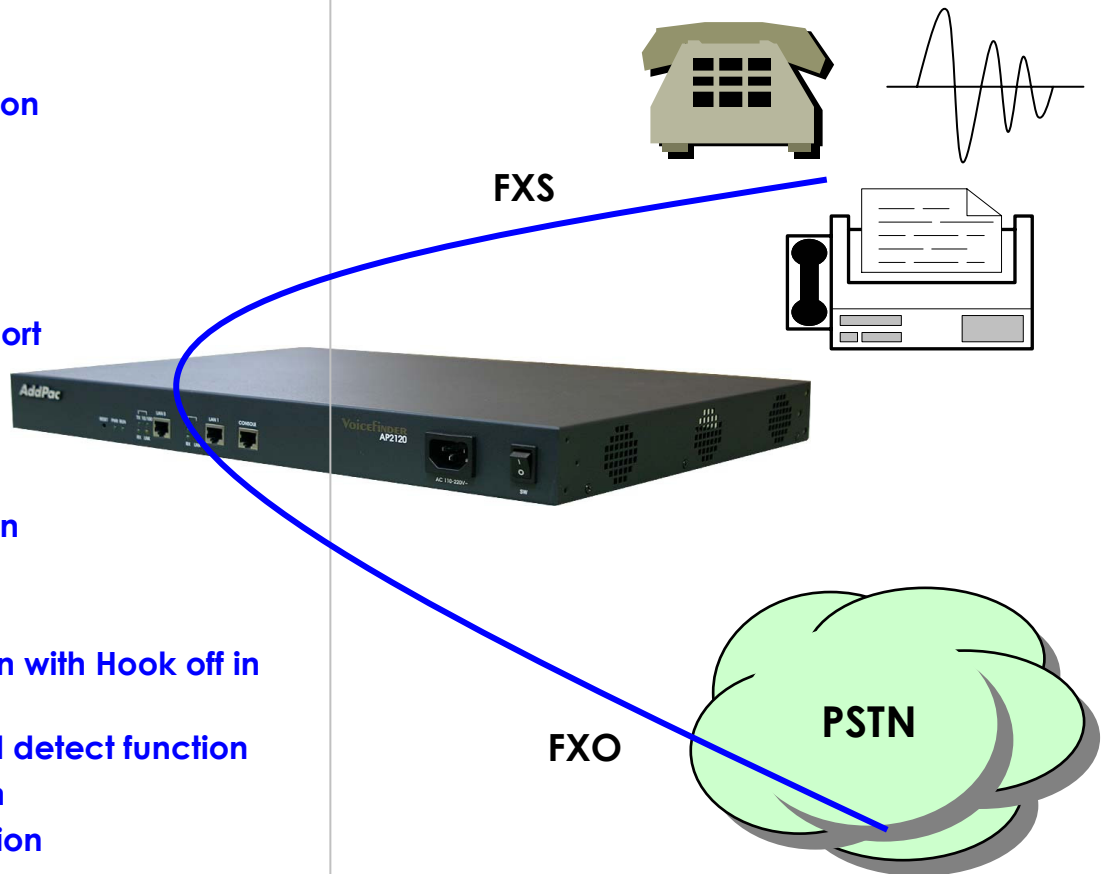

AP2120 VoIP Gateway Product Overview

VoIP Gateway Connectivity

- E&M

- Type 1, 2, 3, 5 support
- 2-wire, 4-wire support
- Delay-dial, Immediate, Wink-wait signaling support
- Dialout-delay, Delay-duration, Delay-start, Wait-wink, Wink-duration, Wink-wait timing setting support

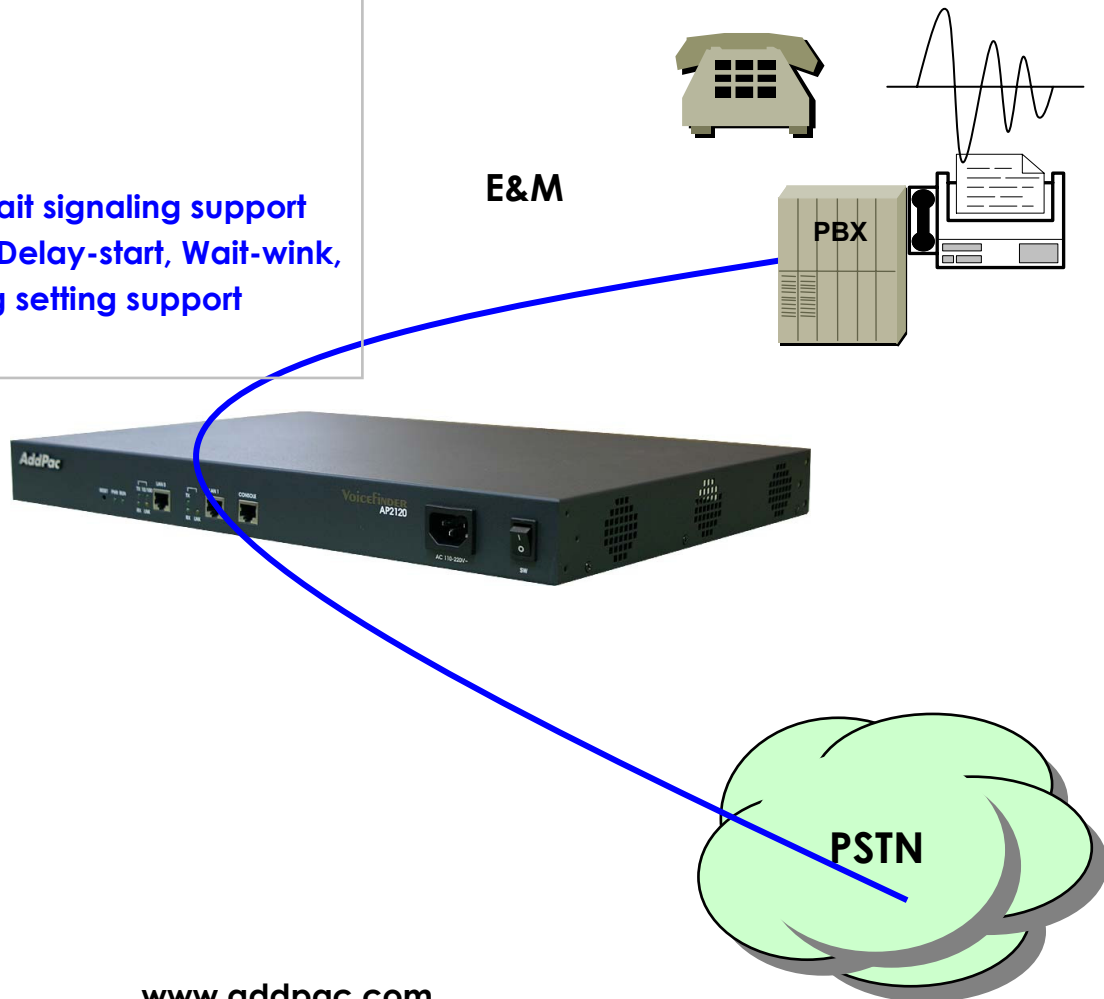

AP2120 VoIP Gateway Product Overview

Voice over IP Service

- **H.323, SIP, and MGCP Triple Stack**
 - Concurrent Triple VoIP Stack Software
 - Single Hardware with Three VoIP Service
 - New APOS-NX Version
- **H.323**
 - ITU-T Standard H.323 v3 Support
 - Support H.245 Tunneling
 - Including H.235 Security Features
- **SIP**
 - IETF RFC3261 or RFC2543 SIP Standard
- **MGCP**
 - IETF RFC2705bis-02 Standard MGCP 1.0

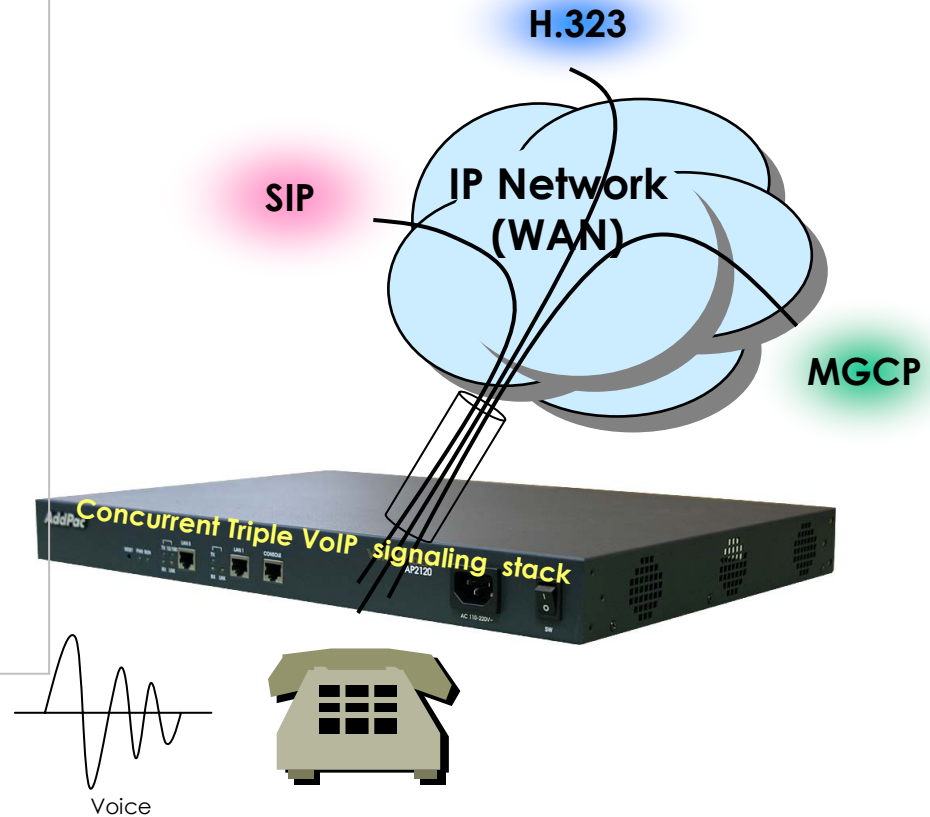

AP2120 VoIP Gateway Product Overview

Voice over IP Service (cont.)

• H.323

- Fast connect, normal connect support
- H.245 tunneling support
- Q.931 response message setting for inbound VoIP calls
- H.245 logical channel open timing selection function
- Start H.245 procedure support
- DTMF / Hook flash relay with H.245 alphanumeric / signal
- Secondary gatekeeper support
- Gatekeeper assignment according to the domain name
- Gatekeeper discovery with multicast
- Lightweight RRQ support
- Signaling TCP port assignment
- Resource threshold setting with RAI
- H.235 clear-token, crypto-token support
- canMapAlias support
- Technical prefix (supported prefix) support
- Public IP assignment in NAT environment



• SIP

- Gateway-based / Endpoint-based registration support
- Secondary proxy-server assignment function
- SIP signaling port change function
- SIP proxy server assignment according to the domain name
- T.38 real-time fax relay support
- DTMF relay support with RFC2833 / OPTION message
- Re-INVITE support

• MGCP

- Secondary call agent assignment function
- Default package assignment
- Announcement Server Package, Generic Media Package, Handset Package, Line Package, Trunk Package support
- MGCP call agent assignment according to the domain name
- T.38 real-time fax relay support
- DTMF relay support based on RFC2833

AP2120 VoIP Gateway Product Overview

Voice over IP Service (cont.)

• Voice Codec

- G.711 A-Law, G.711 U-Law
- G.726 r16, G.726 r32
- G.729A
- G.723.1 r63, G.723.1 r53
- VAD (Voice Activity Detection) function support
- DTMF relay support (H.323, SIP, MGCP common) based on RFC2833

• RTP

- Redundant RTP packet transmission in case of severe packet loss
- Dynamic jitter buffer management and RTP packet jitter and loss compensation with heuristic & DSP error concealment
- Static jitter buffer setting support
- Voice frame per RTP packet number control for each codec
- In-band ring-back tone support
- Virtual ring-back tone support
- Tone parameter change support

• FAX

- Fax relay mode supporting T.38, inband-T.38, bypass mode
- Lost packet compensation with redundant setting in case of T.38 fax relay
- Fax relay mode, rate setting for remote end

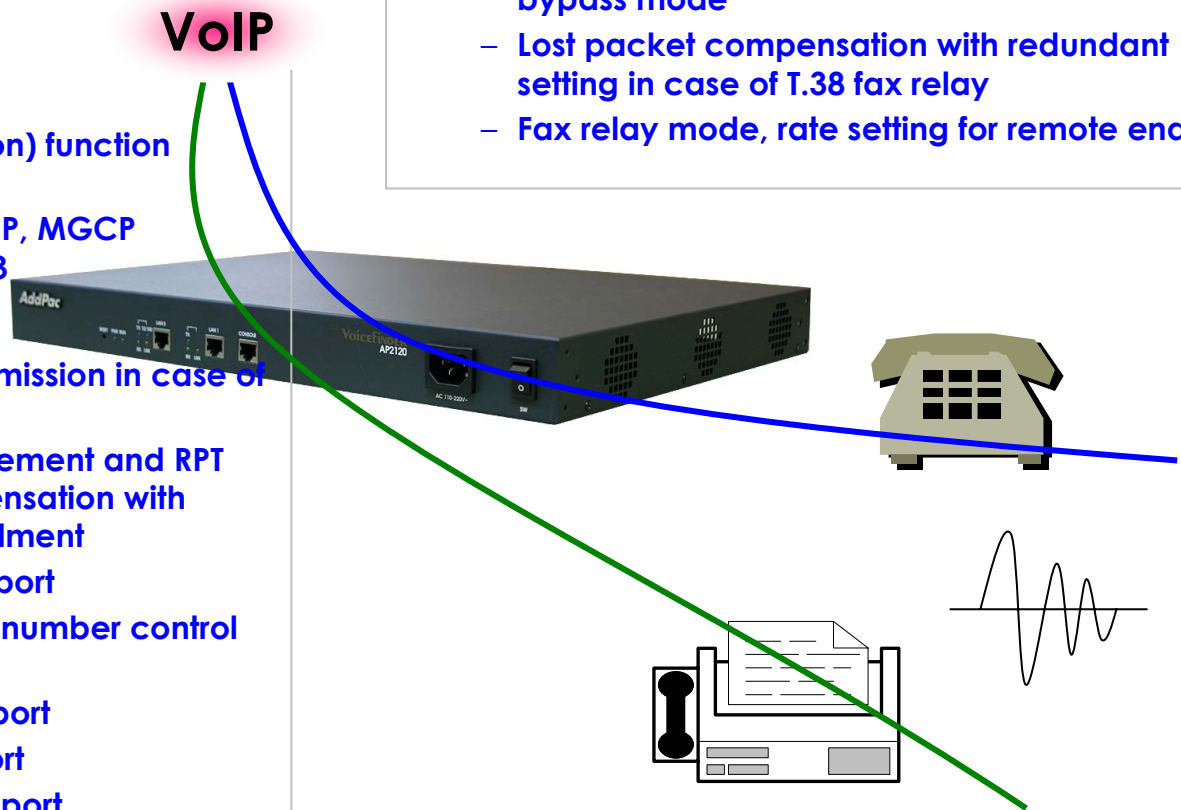

AP2120 VoIP Gateway Product Overview

VoIP Call Managements

• VoIP Call Controls

- Hot line connection function with PLAR (Private Line Auto Ring Down)
- Leased line emulation function
- Connection monitoring function
- Fault tolerant with Redundancy and Call Distribution among Gateways for load balancing
- Call attempt with IP address
- H.323, SIP, MGCP inbound call connection for each voice port
- Multiple E.164 setting for one voice port
- One E.164 or digit pattern can be assigned to more than one voice port
- Hunting with Longest match/ priority/ sequence/ random
- One stage call setup by Digit forwarding
- Call barring with specific digit patterns
- Calling and called number conversion for PSTN outbound calls
- PSTN rerouting in case of VoIP call attempt failure

• VoIP Call Controls (cont.)

- Call transfer for internal calls
- Call pickup for internal calls
- Calling and called number conversion for VoIP outbound calls
- Calling and called number conversion for VoIP inbound calls
- Fax broadcasting call control

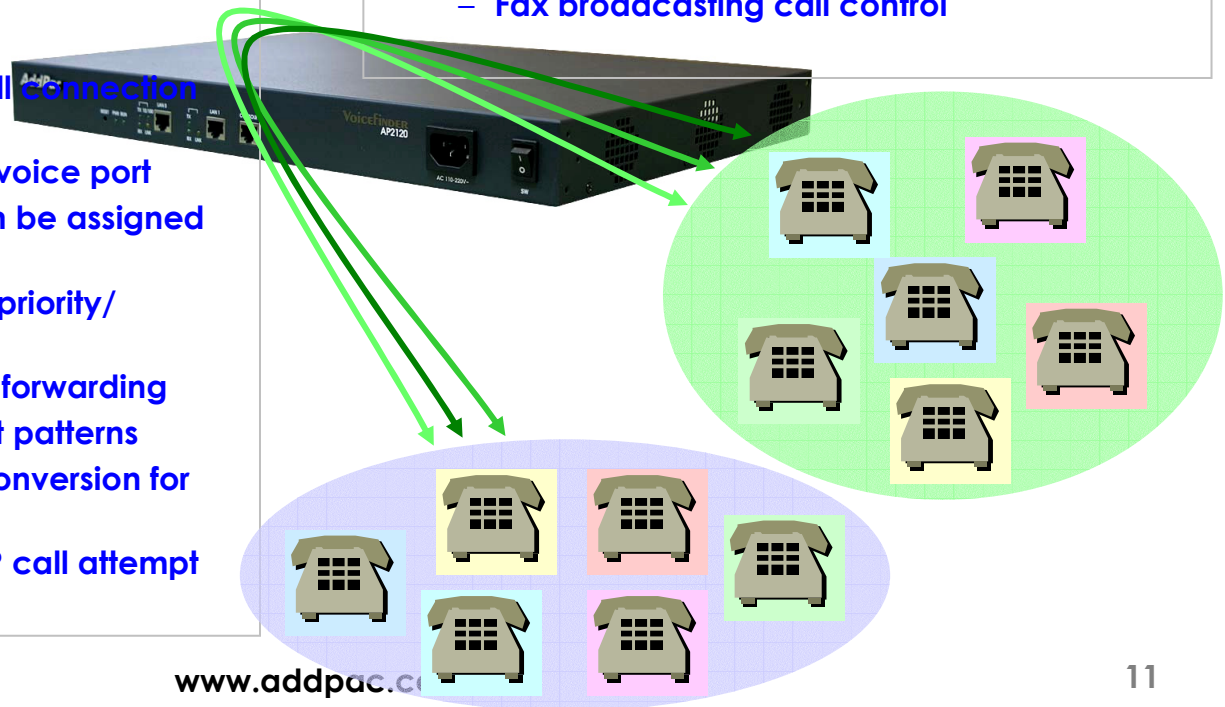

AP2120 VoIP Gateway Product Overview

Enhances QoS Managements

- Enhances **Transmit** Voice QoS Features

- Voice Traffic Priority Queuing
- QoS Service Profiling
- Providing Virtual Network Transmit Algorithm
- Real-time Voice Traffic QoS Support
- RTP Packet Transmit Interval Control
- Supporting RTP Packet Redundancy Scheme
- IP Header Control such as ToS, Diffserv

- Enhances **Receive** Voice QoS Features

- Dynamic Jitter Buffer Management
- Error Concealment
- Support T.38 FAX Data Error Recovery Scheme

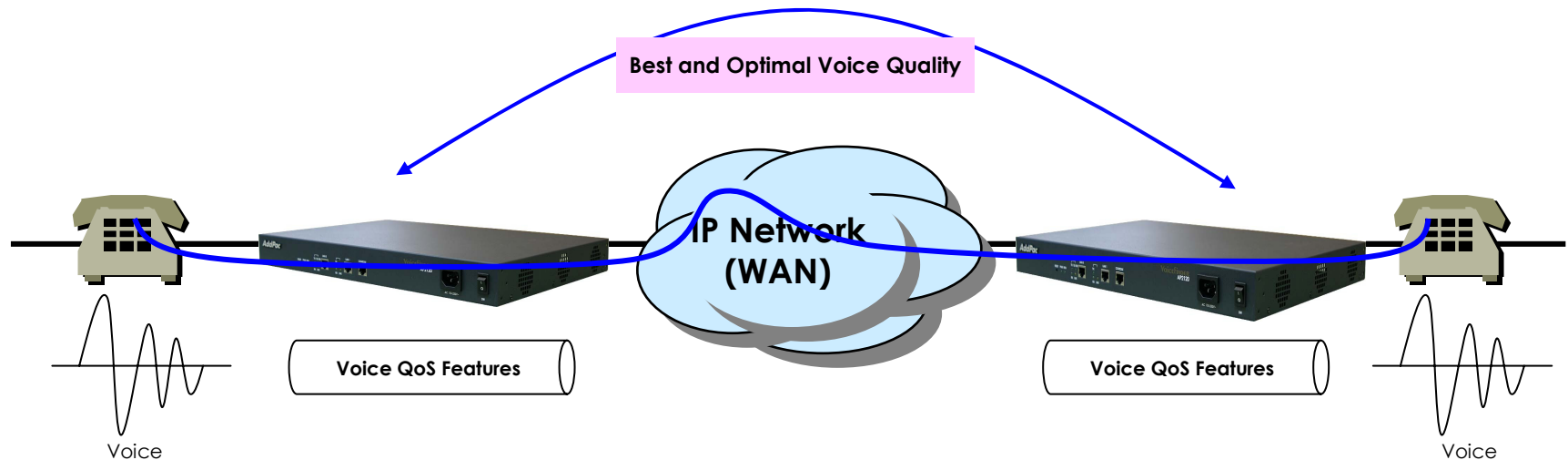

AP2120 VoIP Gateway Product Overview

Enhances QoS Managements (cont.)

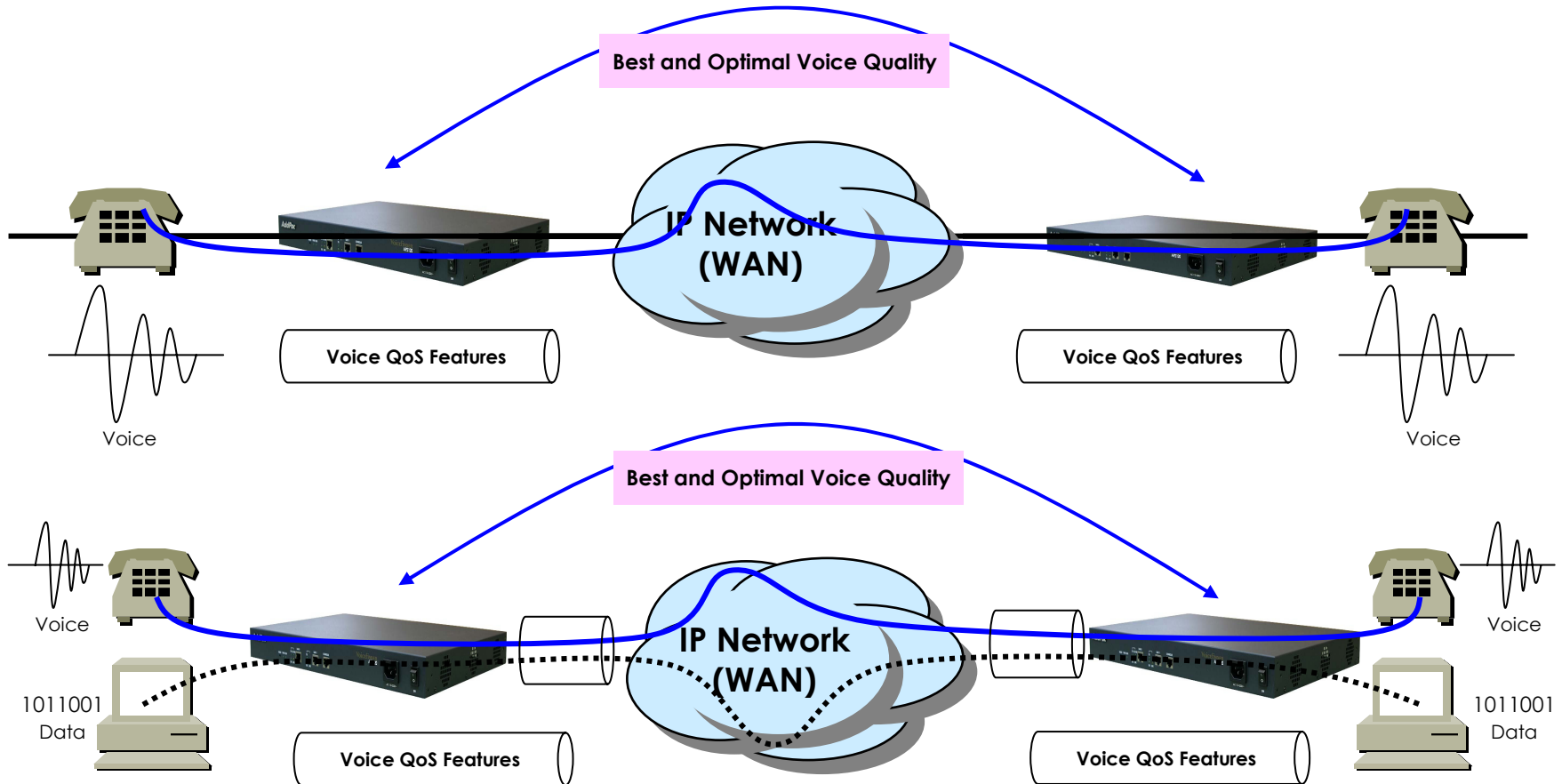

AP2120 VoIP Gateway Product Overview

Enhances QoS Managements (cont.)

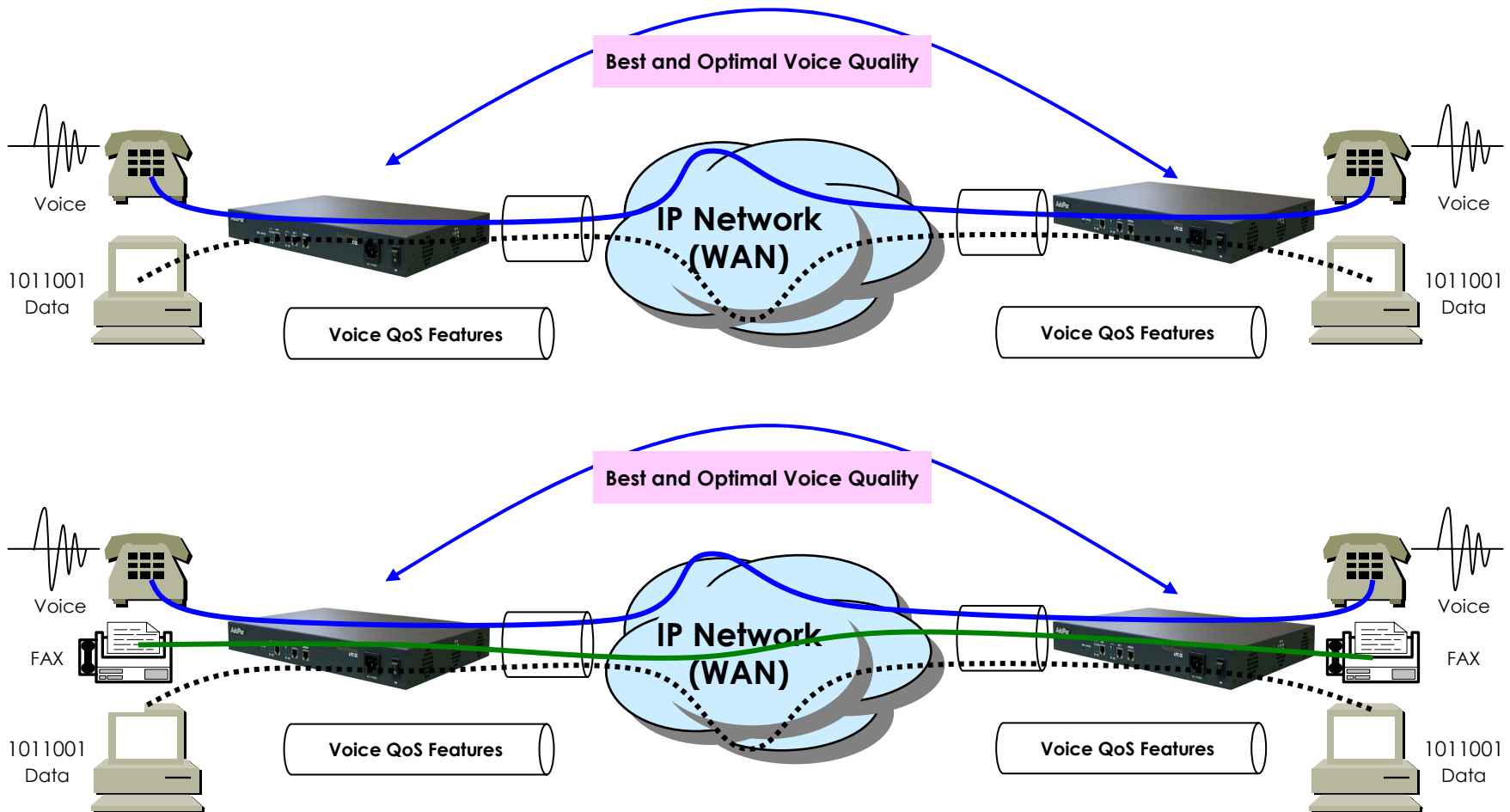

AP2120 VoIP Gateway Product Overview

Enhances QoS Managements (cont.)

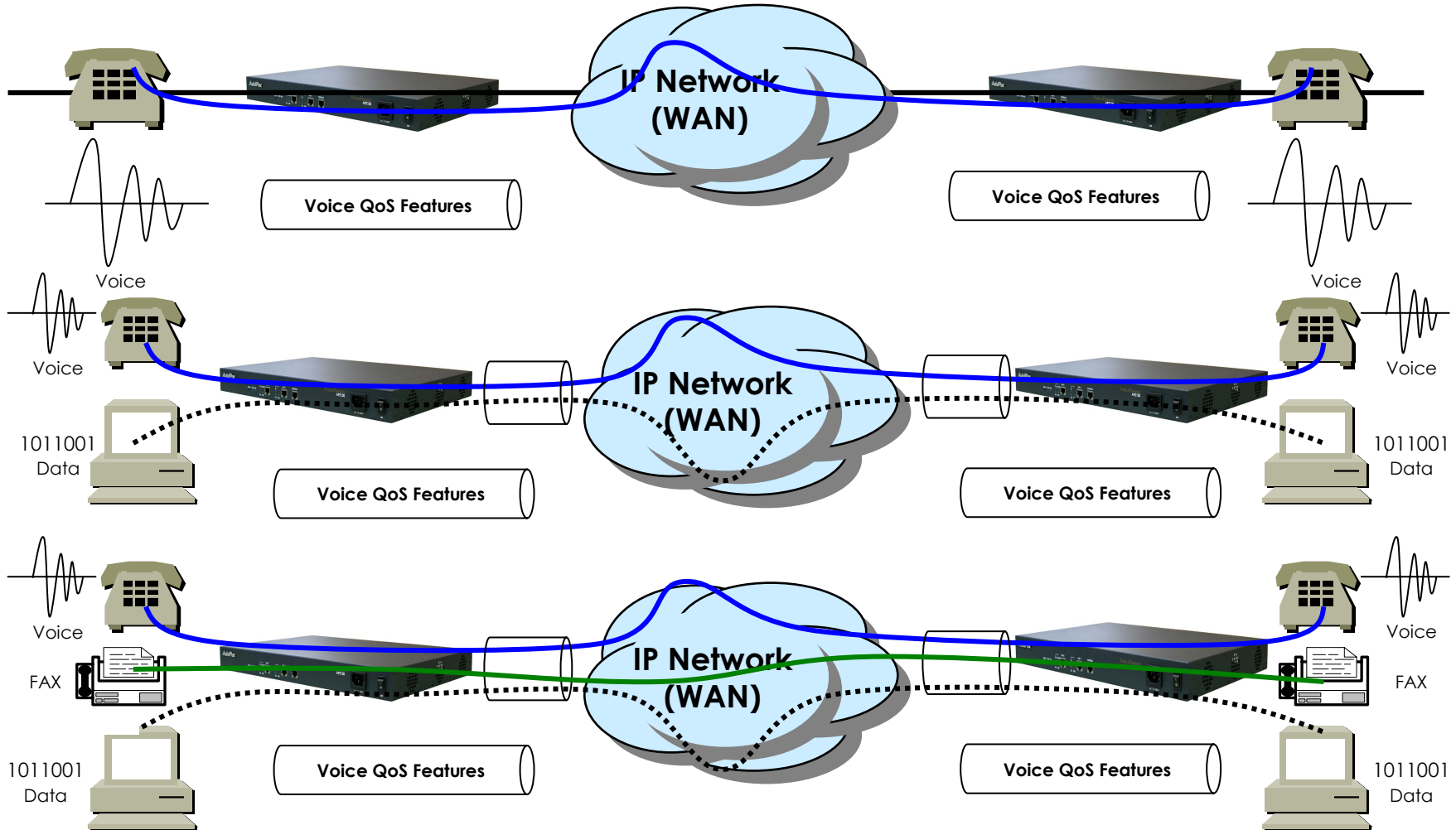

AP2120 VoIP Gateway Product Overview

IP and WAN Protocols

- **IP Routing Protocols**

- Multi-protocol Internetworking Services
- Static IP routing
- RIP v1/v2 (opt.)
- OSPF v2 routing protocols support (opt.)
- Transparent Bridging (IEEE Spanning Tree Protocol)

- **WAN Protocols**

- Point-to-Point Protocol (PPP)
- High-level Data Link Control (HDLC) Protocol

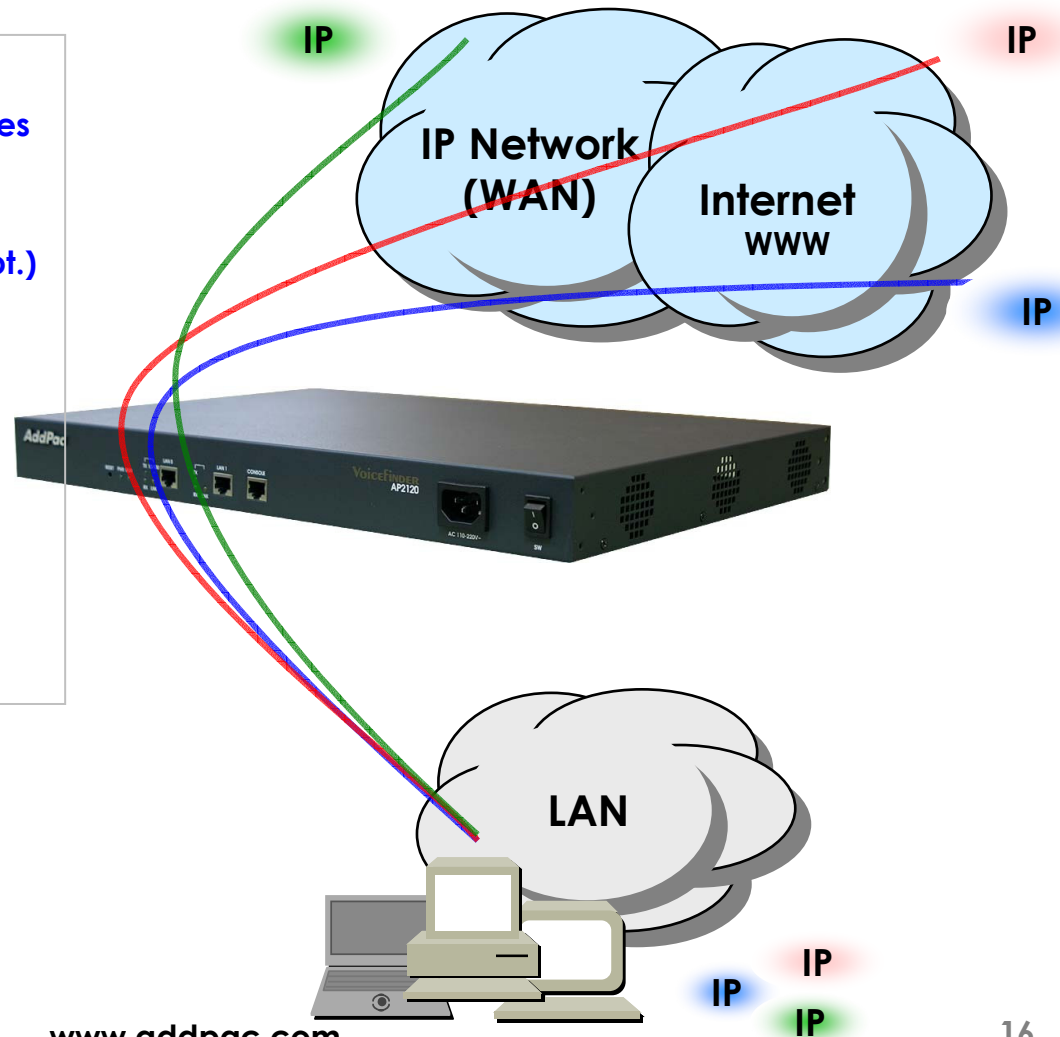

AP2120 VoIP Gateway Product Overview

Network Managements

- **SNMP**

- Standard Simple Network Management Protocol(SNMP) Agent support
- MIB v1 and v2 Support

- **Web-based Management**

- Standard Voice Interface
- Standard PSTN Back-up Interface

- **Watch-dog Function**

- Hardware, Software watch-dog services

- **Remote Management**

- Telnet
- Rlogin
- Console

- **Auto Upgrade Service**

- HTTP server based APOS image and configuration file auto-upgrade support

- **Batch Job Function**

- Text based script downloading

- **Easy Set-up Service**

- MS Windows Graphical User Interface (GUI) based installation Software Solution
- Easy installation Set-up service

- **Interoperable with AP-VPMS Service**

- AddPac VoIP Plug & Play Management System (AP-VPMS)

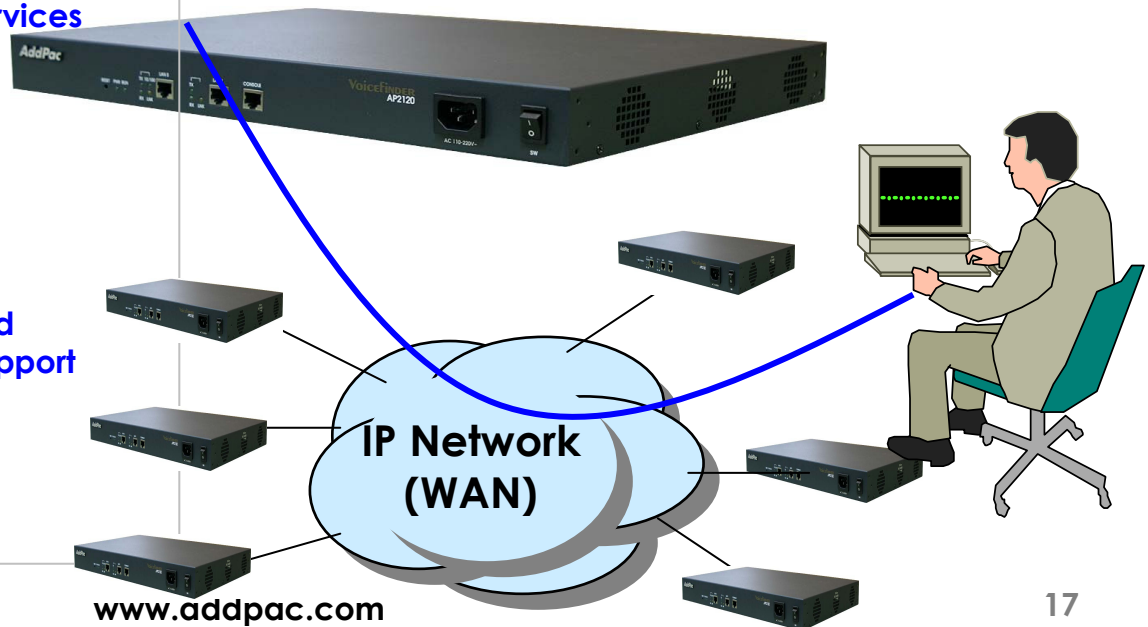

AP2120 VoIP Gateway Product Overview

Security Managements

- IP packet filtering
- IP access list
- User authentication function
 - Password Authentication Protocol (PAP)
 - Challenge Handshake Authentication Protocol (CHAP)
- Enable/Disable specific protocols
- Auto-square connect of console and Telnet session
- Account Management function for multi-level user
- SNMP/TELNET/FTP/HTTP/TFTP port assignment function
- SNMP/TELNET/FTP access list management
- Boot mode security checking function

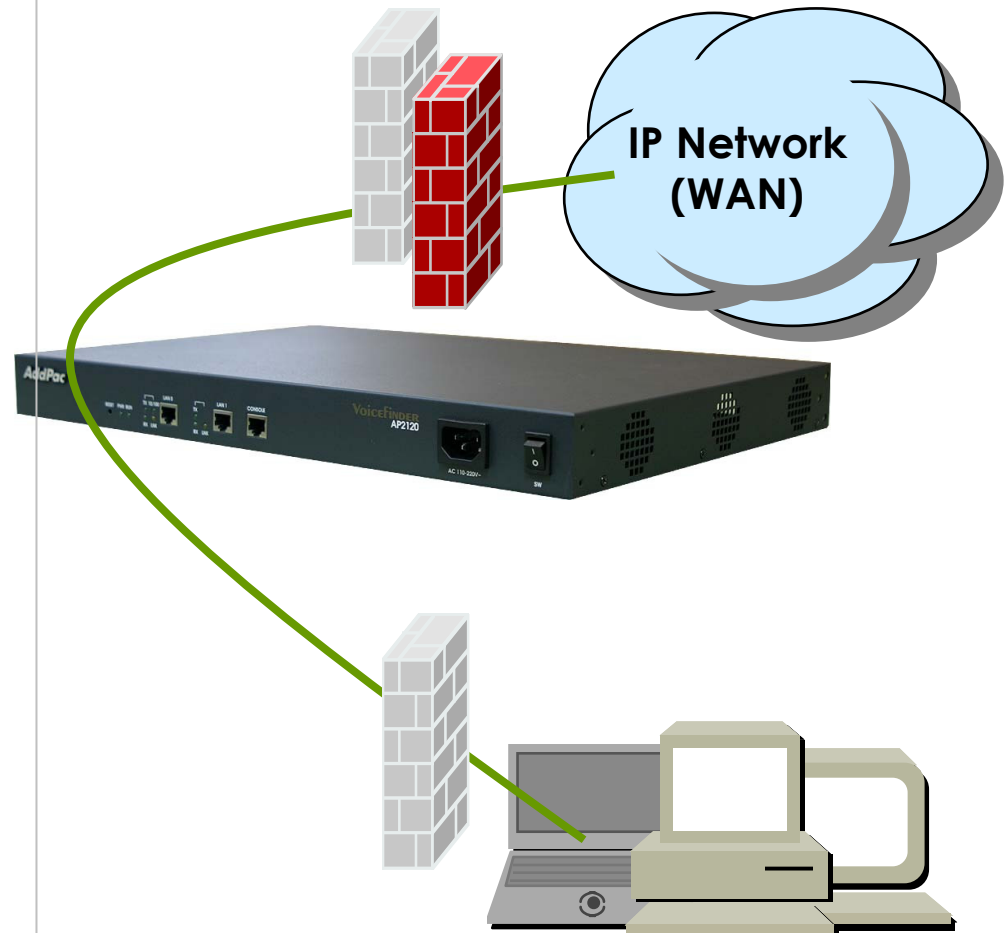

AP2120 VoIP Gateway Product Overview

Network Scalability

- **IP Sharing Feature**

- Single IP Address, Multiple IP Network Access
- Public IP Address Sharing by VoIP Gateway

- **IP Sharing Network Environment**

- Support Legacy Network Environment
- xDSL Modem based Broadband Network
- Cable Modem based Broadband Network
- Leased line Network Environment

- **Both support Fixed and Dynamic IP**

- **Support Standard Network Protocols**

- PPPoE
- PPPTP
- DHCP

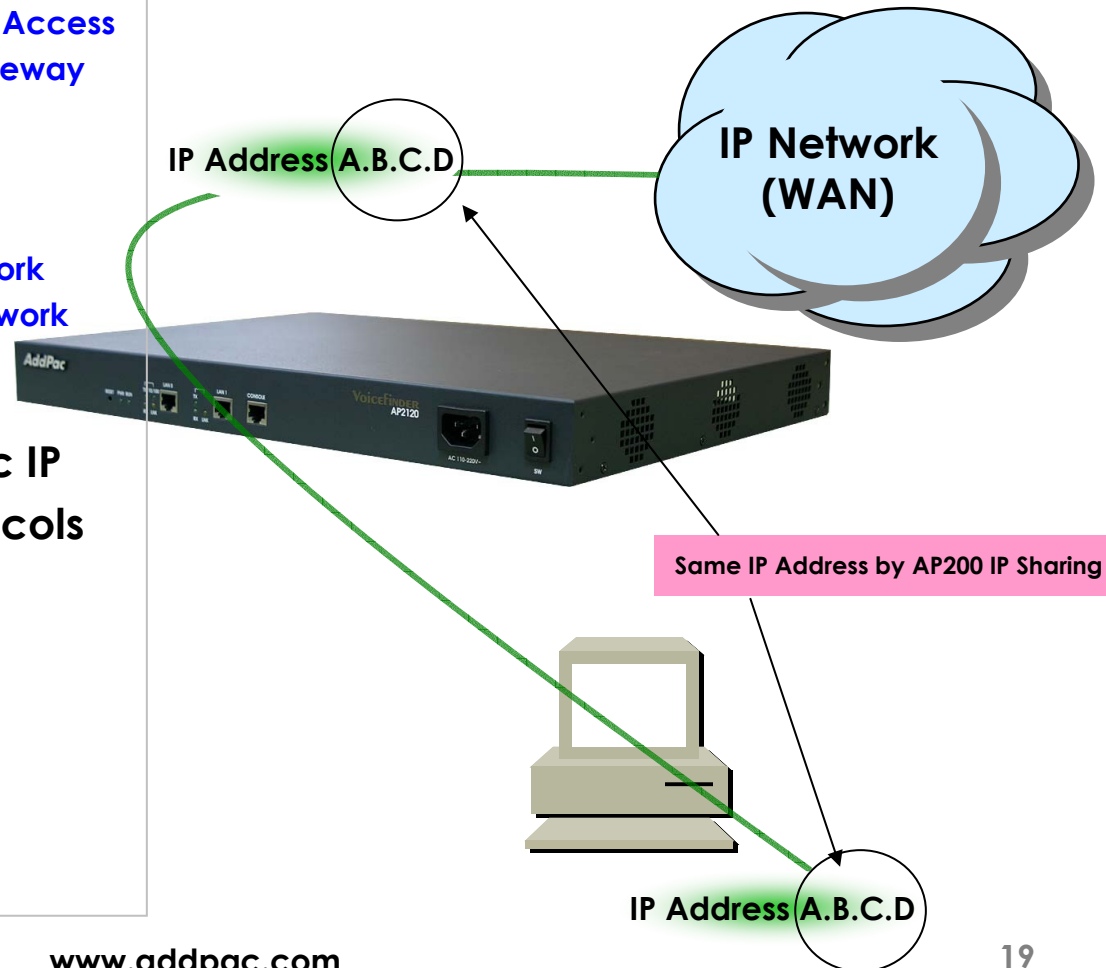

AP2120 VoIP Gateway Product Overview

Network Scalability (cont.)

- **Bridging Service**
 - Spanning Tree Bridging protocol (IEEE) support
- **DHCP**
 - Server and Relay
- **IP Accounting**
- **PAT (Port Address Translation)**
- **NAT (Network Address Translation)**
- **Cisco Style CLI (Command Line Interface)**
- **PPTP (Point-to-Point Tunneling Protocol)**
- **NTP (Network Time Protocol)**
- **FTP/TFTP**
 - Server and Client support
- **DNS**
 - Dynamic DNS Client support

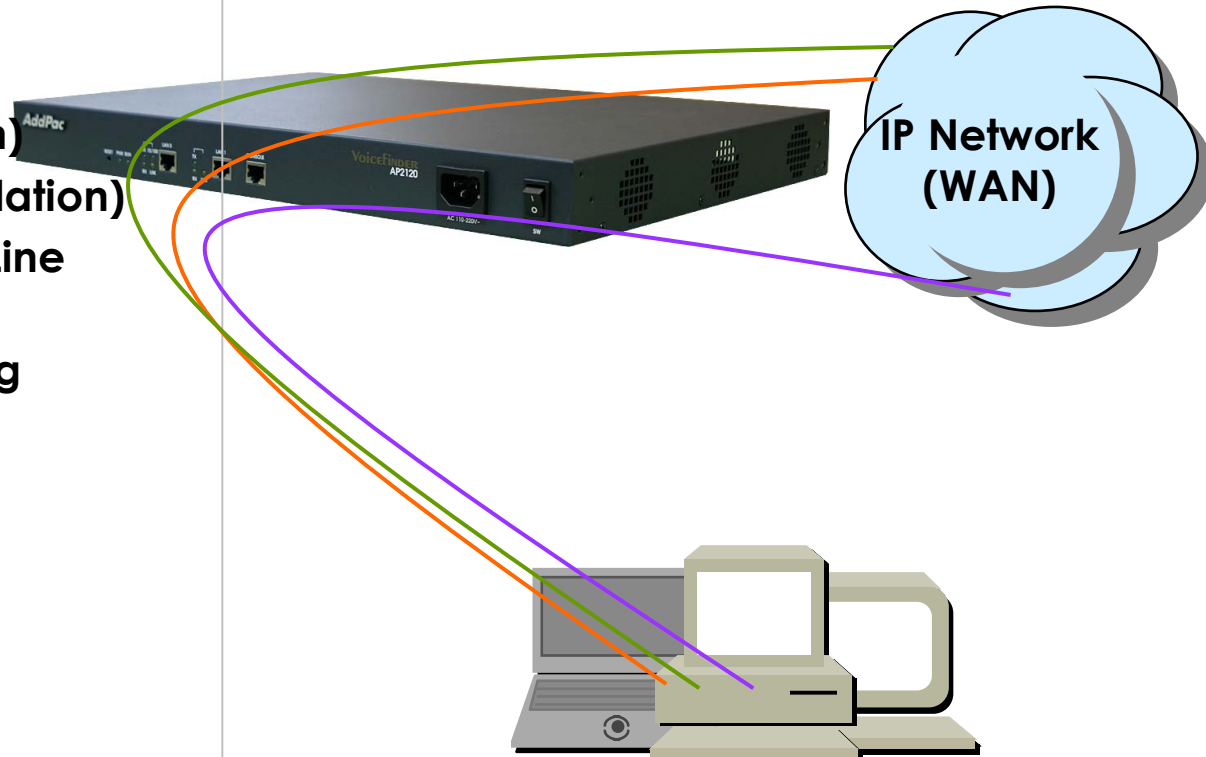

AP2120 VoIP Gateway Product Overview

VoIP Plug & Play System (VPMS)

- **AddPac AP-VPMS Support**
 - AddPac VoIP Plug & Play System (VPMS)
 - Best EMS Solutions for AddPac VoIP G/W
- **Requirements Hardware Platform**
 - Over 1GHz Intel Pentium 4 Machine
 - Over 1GB Main Memory
 - Over 40GB Hard Disk Memory
 - Microsoft Windows Advanced Server or Windows 2000 Server or Windows XP Professional
 - DBMS : Microsoft MS-SQL Server 2000

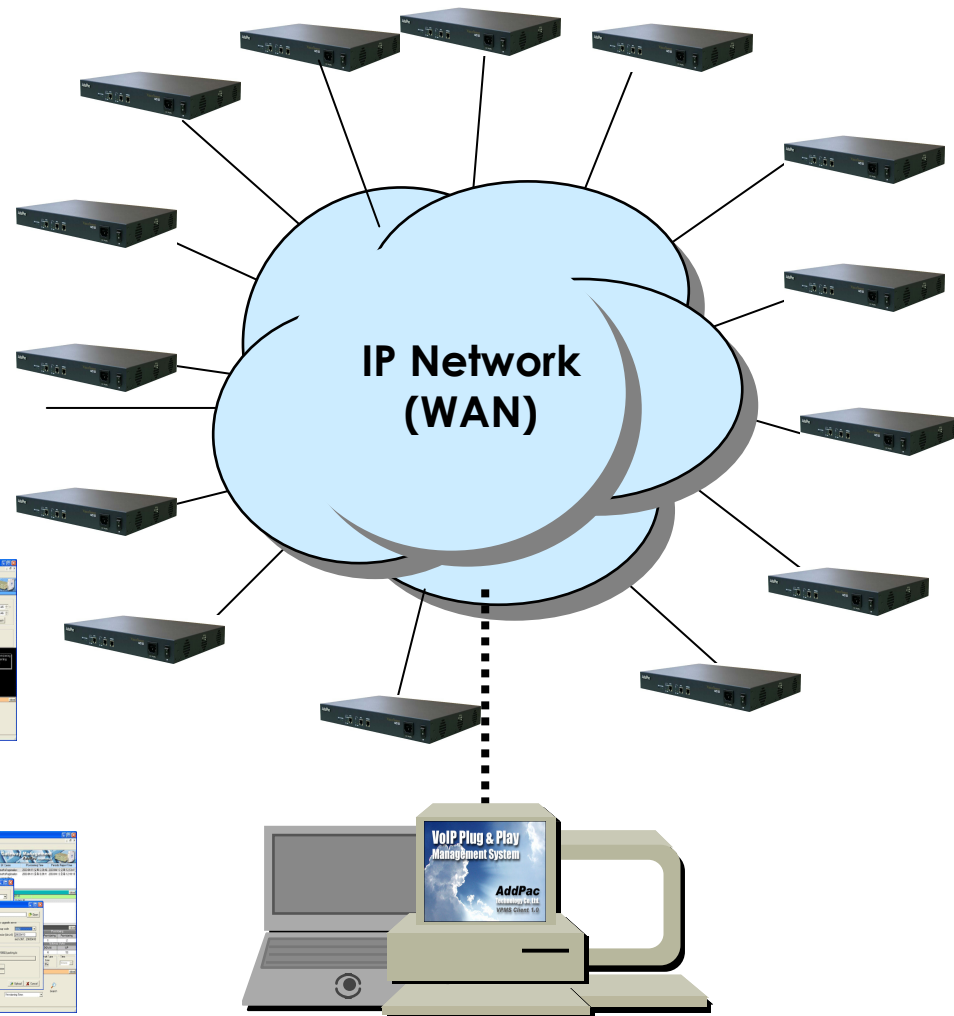

AP2120 VoIP Gateway Product Overview

AP2120 Network Configurations

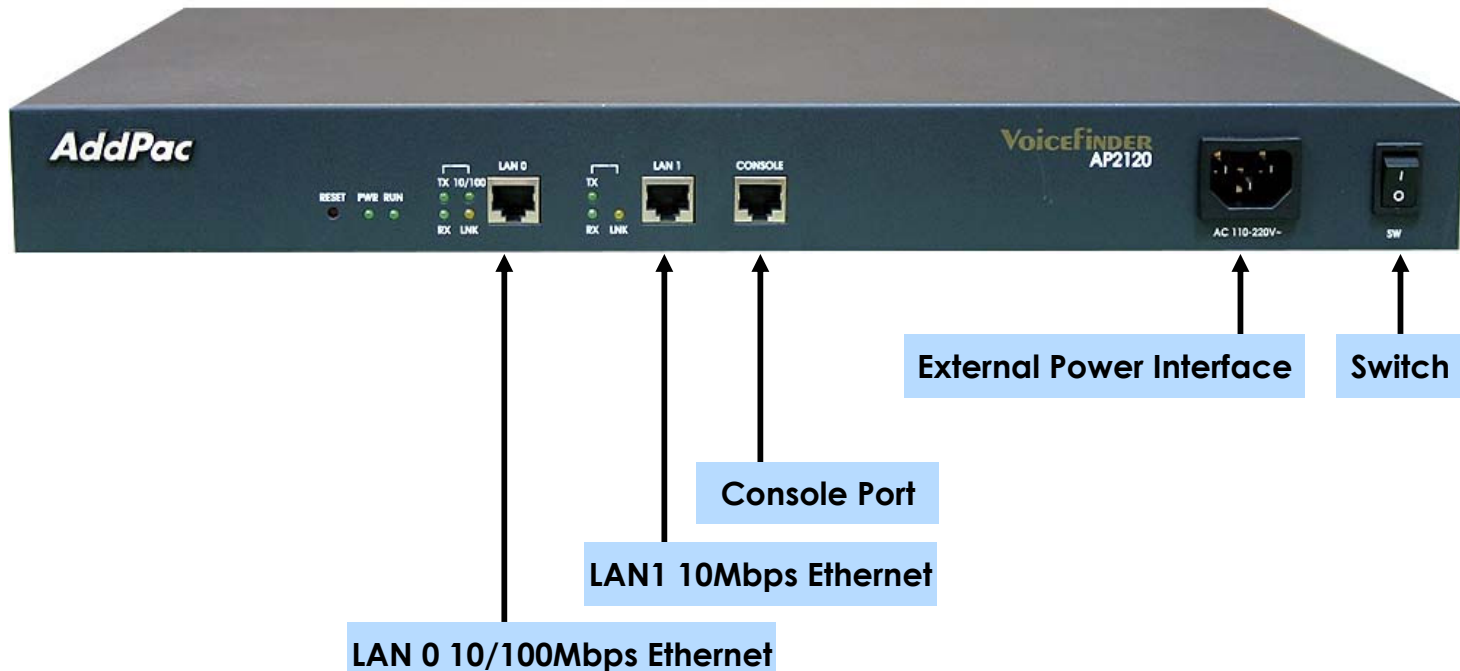

AP2120 VoIP Gateway Product Overview

AP2120 Hardware Specification



Status LEDs

Voice Module 0 Slot

Voice Module 1 Slot

AP2120 VoIP Gateway Product Overview

AP2120 Analog Voice Module



AP-FXS8 Module



AP-FXO8 Module



AP-FXS4O4 Module



AP-E&M8 Module

AP2120 VoIP Gateway Product Overview

AP2120 Voice Module (NGN)



AP-FXS8H Module

• Product Highlight

- ✓ Supports Long reachable distance
(Between telephones & VoIP switching gateway)
- ✓ Powerful surge protection
(central exchange and MDF installation)
- ✓ Noise immunity with built-in LPF function (ADSL/ VDSL)
- ✓ Supports existing PSTN numbering plan
- ✓ Centralized management
(reduced maintenance expenses)
- ✓ Supports powerful ringing for various analog phone
- ✓ Supports caller ID
- ✓ Simplified, distributed IP telephone switching

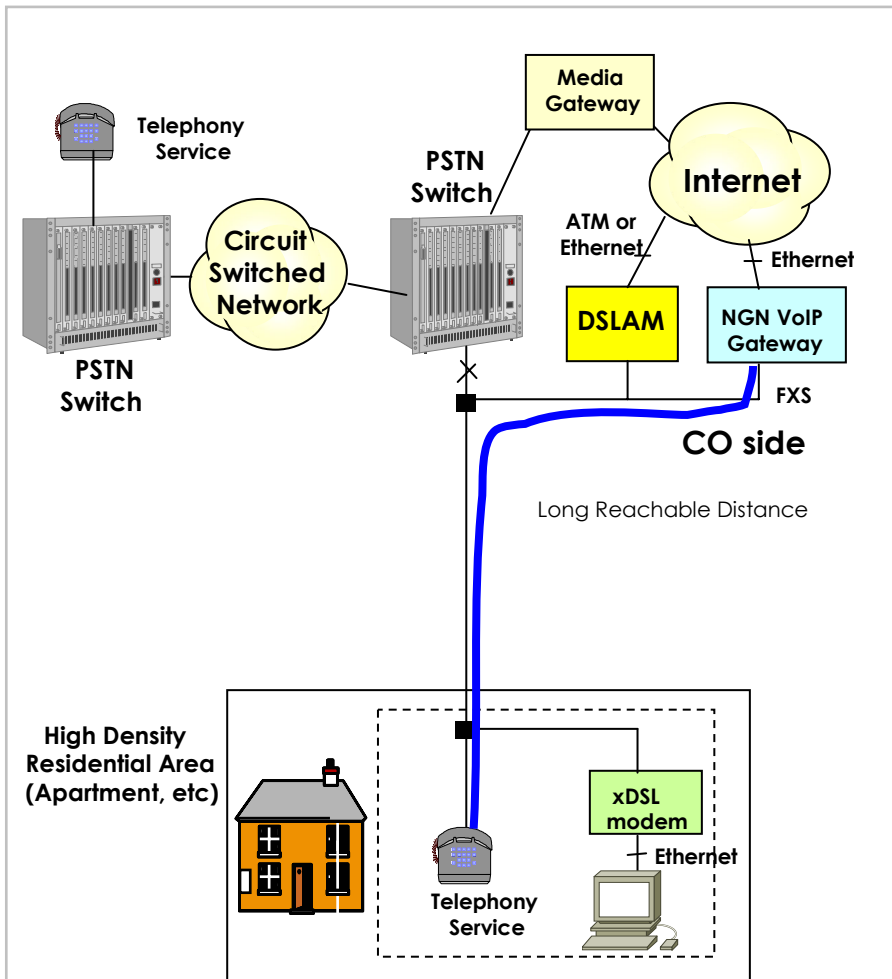

AP2120 VoIP Gateway Product Overview

AP2120 Hardware Specification

AP2120 VoIP G/W	Basic Specifications
CPU	PowerPC 32Bit RISC Microprocessor
Voice Interface	8-Ports FXS,8-Ports FXO,8-Ports E&M, 4FXS4FXO Voice Interface
Ethernet Interface	1-Ports 10/100Mbps Ethernet Interface(RJ-45) 1-Ports 10Mbps Ethernet Interface(RJ-45)
Console Port	1-Port RS-232C Console Port(RJ-45)
Flash Memory	4Mbyte High-speed Flash Memory _____
Base Memory	32Mbyte High-speed SDRAM
Boot Memory	512Kbyte Flash Memory
Power Requirement	VAC110~220V, 50/60Hz, 40Watt
Operating Temperature	0°C ~ 50°C (32 °F ~ 122°F)
Storage Temperature	-40°C ~ 85°C (-40°C ~ 185°F)
Relative Humidity	5% ~ 95% (Non-condensing)
Dimensions	44mm x444mm x 220mm (H x W x D)
Weight (g)	3.5Kg
Regulations	MIC

AP2120 Voice Networking Configuration

Inter-office calls

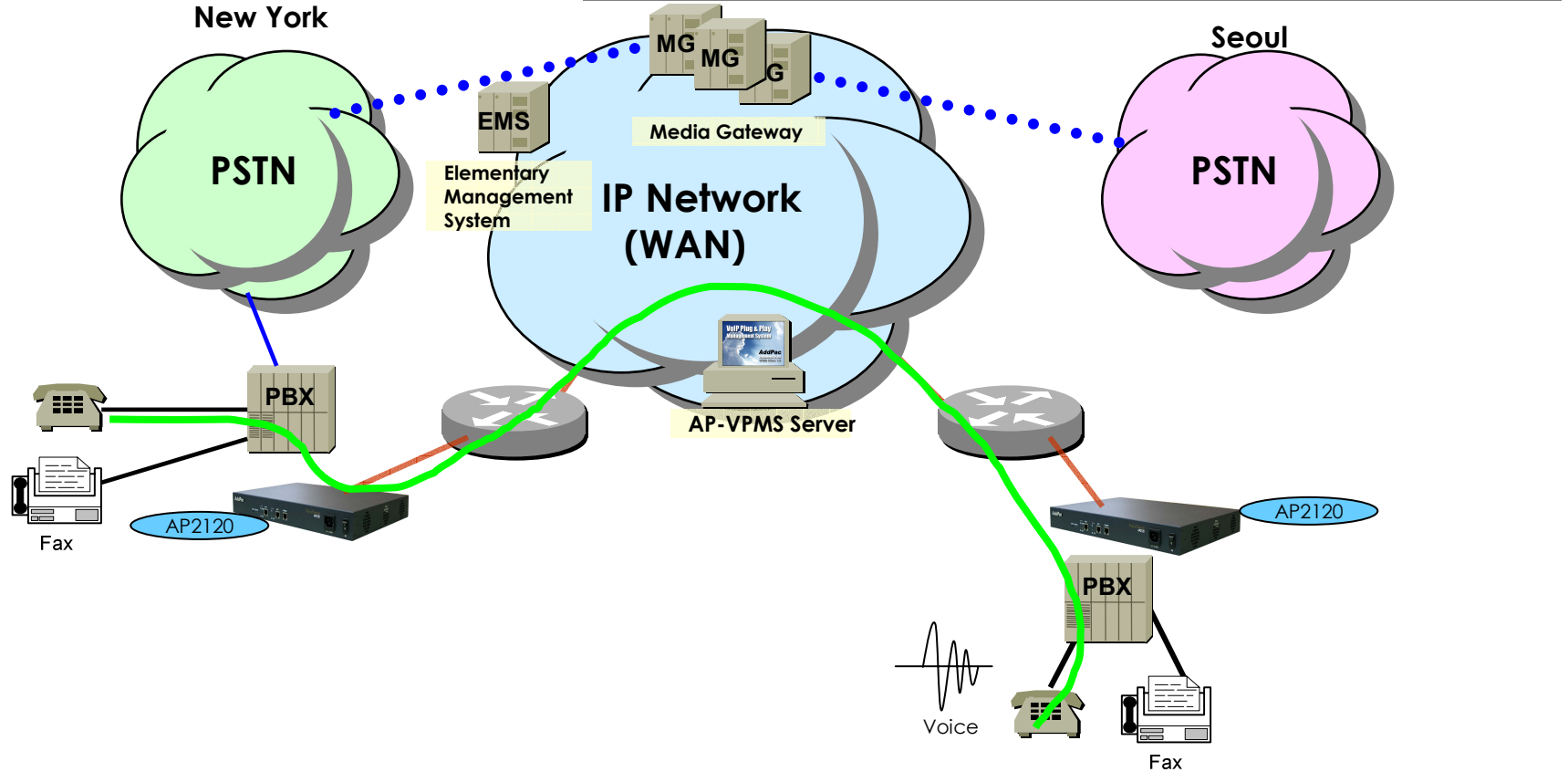

 Voice Call Flow

 PSTN Interface

 Voice+Data, Ethernet or WAN Interface

 TRUNK n x E1 Voice Interface for PSTN Interworking

 Leased Line/ATM/Frame-Relay/IP Router, xDSL/Cable Modem, etc.

 AddPac AP2120 Voice over IP Gateway

 Analog Phone

AP2120 Voice Networking Configuration

VoIP to PSTN Inter-working Call Flow

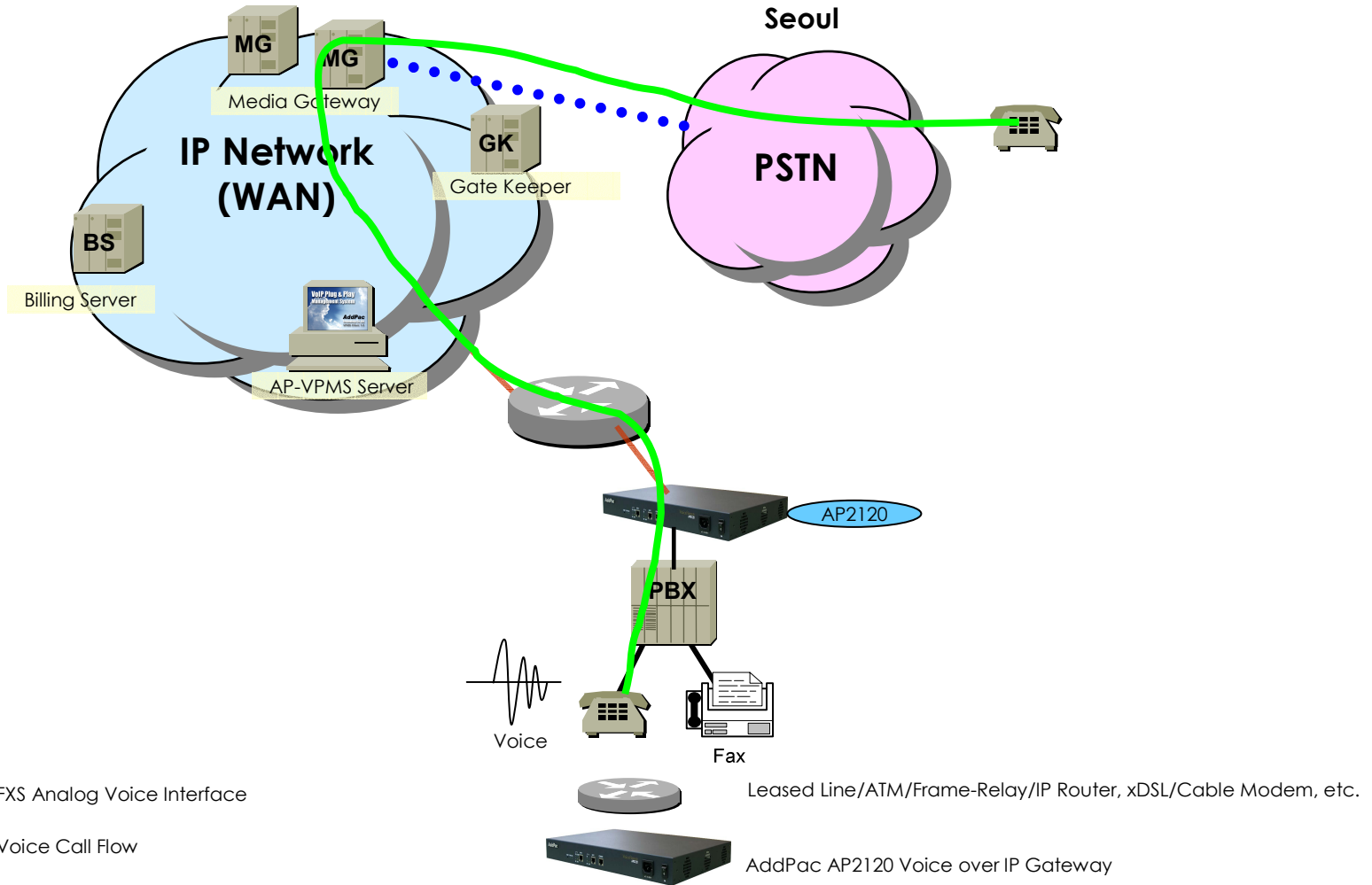

AP2120 VoIP Gateway Product Overview

AP2120 Ordering and Pricing

- **AP2120 VoIP Gateway**

- **VoIP Gateway Hardware**

- One(1)Fast Ethernet, One(1) Ethernet Console
 - 2 Voice Interface Modules
 - 32bit RISC CPU, 4MB Flash, 32MB SDRAM
 - APOS v5.xx with Operation Manual
 - Including CAB-LAN, CAB-CON

- **2120-FXS8** 8Port FXS Interface Module
 - **2120-FXO8** 8Port FXO Interface Module
 - **2120-E&M8** 8Port E&M Interface Module
 - **2120-FXS4O4** 4Port FXS & 4Port FXO Interface Module



- **Pricing**

- AddPac Technology Regional Sales Managers
 - Authorized Sales and Marketing Representatives
 - Please Contact www.addpac.com

AP2120 VoIP Gateway Product Overview

AP2120 Comparison Table

	AP2120 VoIP Gateway
▶ FXS Voice Ports (RJ11)	Up to 16
▶ FXO Voice Port (RJ11)	Up to 16
▶ E&M Voice Module	Up to 16
▶ 10Mbps Ethernet Ports (RJ45)	1
▶ 10/100 Mbps Ethernet Ports (RJ45)	1
▶ Console Ports (RJ45)	1
▶ CPU	Power PC 32Bit RISC
▶ Flash Memory	4Mbyte
▶ Base Memory	32Mbyte
▶ Power Requirement	VAC 110~220V, 50/60Hz, 40Watt
▶ Internetworking OS	APOS
▶ H.323, SIP VoIP Protocol, T38 FAX, MGCP	YES
▶ PPPoE, PPTP Network Protocols	YES
▶ Enhanced QoS Management Feature	YES
▶ IP Routing Protocols Including NAT	YES
▶ Network Management Protocols	YES
▶ Support Network Environments	ADSL, VDSL, Cable Modem, Leased Line, ATM, Frame-Relay, Including Conventional Broad Band Networking

Thank you !

www.addpac.com

Technical Sales and Marketing

Phone : +82 2 568 3848

Fax : +82 2 568 3847

sales@addpac.com