

AP1200™ Analog VoIP Gateway

Public IP + IP Sharing + Cascading



AddPac

AddPac Technology

Sales and Marketing

www.addpac.com

Contents

- AP1200 HW Specification
- Public IP + NAT/PAT
- Public IP + IP Sharing + Cascading
- Private IP

AP1200 HW Specification

- **RISC Microprocessor Computing Power**
- **High quality Voice Interface**
 - AP1200A : 4-Port FXS, 1-Port FXO
 - AP1200B : 8-Port FXS, 1-Port FXO
 - AP1200C : 4-Port FXS, 4-Port FXO
 - AP1200D : 8-Port FXO
- **Network Interface**
 - Two(2) 10/100Mbps Fast Ethernet
 - One(1) RS-232C Console (RJ45 Connector)
- **Power Supply**
 - Power ON/OFF Switch
 - External Power Adaptor (5V, 5A)

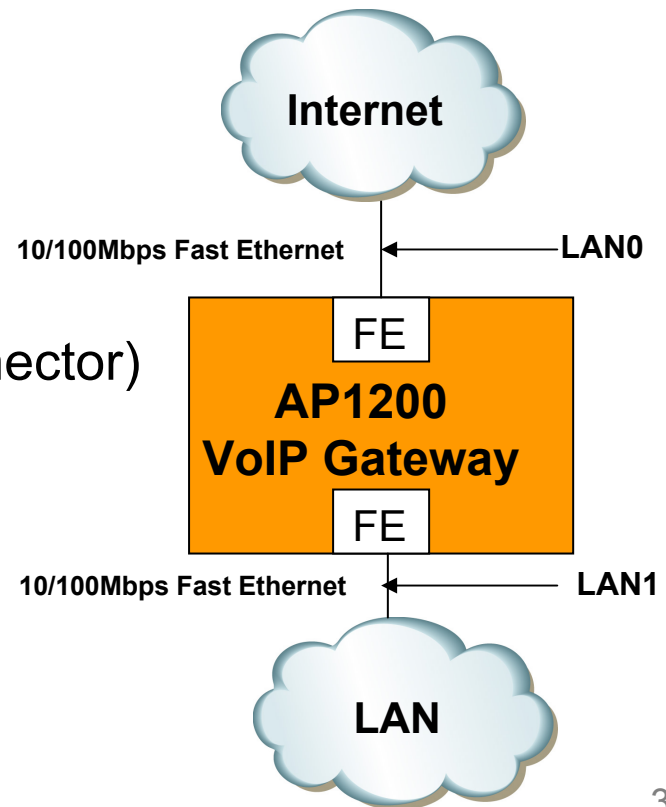

Public IP + NAT/PAT Network Diagram

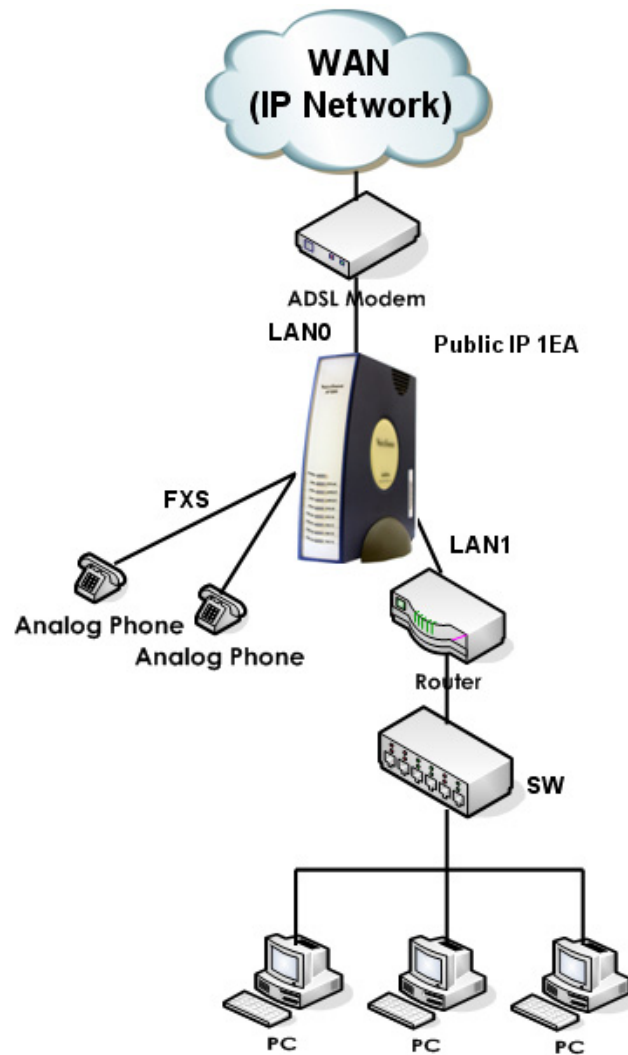

Public IP (Static IP) + NAT/PAT

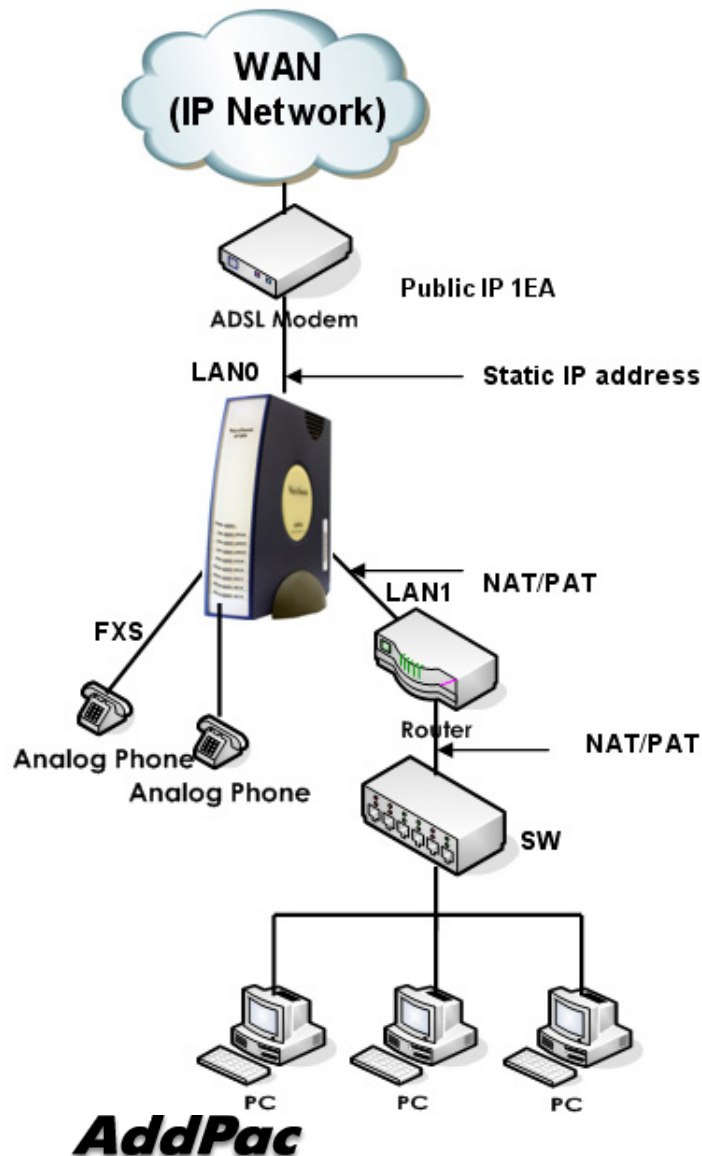

(1) Interface ethernet 0 static ip address

```
dhcp-list 1 type server
dhcp-list 1 address server 10.1.1.2 10.1.1.254 255.255.255.0
dhcp-list 1 option dns 10.1.1.1
dhcp-list 1 option router-option 10.1.1.1
!
nat-list 1 pat static-entry tcp 1720 local
nat-list 1 pat static-entry udp 5060 local
nat-list 1 pat group-static-entry udp 22000 22001 local
nat-list 1 pat group-static-entry udp 23000 24999 local
nat-list 1 pat group-static-entry tcp 10000 10999 local
nat-list 1 pat group-static-entry tcp 14000 14999 local
nat-list 1 pat group-static-entry tcp 18000 18999 local
nat-list 1 pat static-entry tcp 23 local
nat-list 1 pat group-static-entry tcp 20 21 local
nat-list 1 pat group-static-entry udp 67 68 local
nat-list 1 pat static-entry icmp ping local
!
no ip-share enable
interface ether0.0
ip address 200.212.149.130 255.255.255.192
!
interface ether1.0
ip address 10.1.1.1 255.255.255.0
ip nat-group 1 pat ether0.0
ip dhcp-group 1
!
route 0.0.0.0 0.0.0.0 200.212.149.1
```

Public IP (DHCP) + NAT/PAT

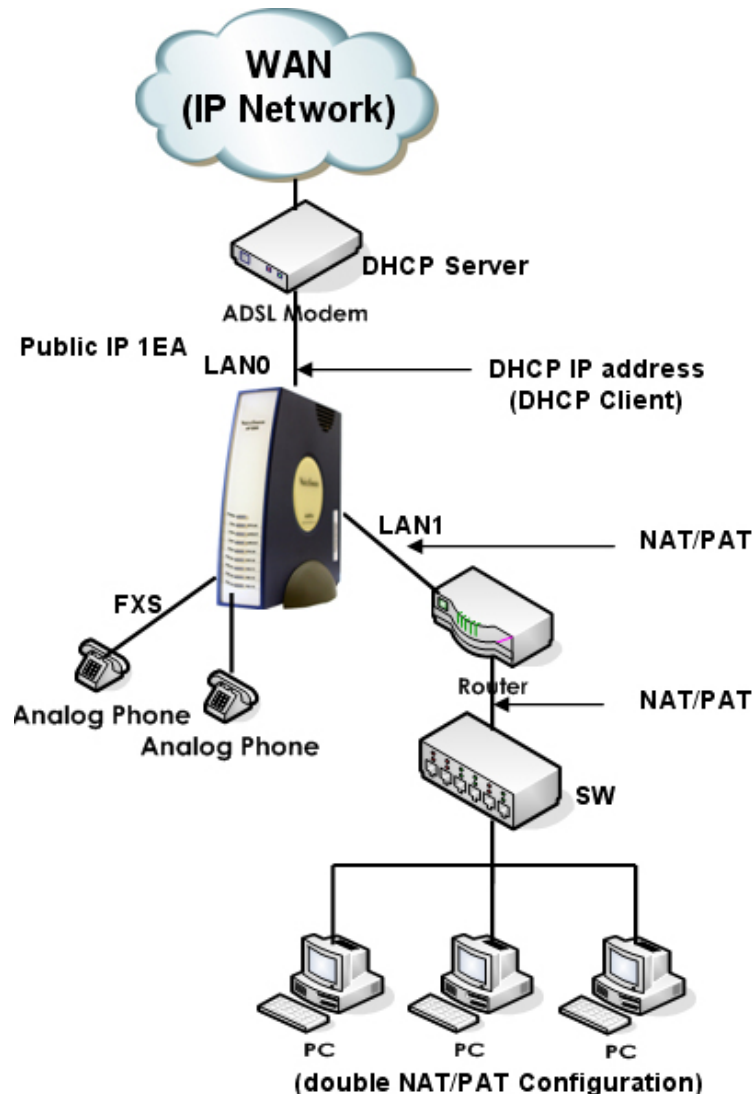

2) Interface ethernet 0 dhcp ip address

```

dhcp-list 1 type server
dhcp-list 1 address server 10.1.1.2 10.1.1.254 255.255.255.0
dhcp-list 1 option dns 10.1.1.1
dhcp-list 1 option router-option 10.1.1.1
!
nat-list 1 pat static-entry tcp 1720 local
nat-list 1 pat static-entry udp 5060 local
nat-list 1 pat group-static-entry udp 22000 22001 local
nat-list 1 pat group-static-entry udp 23000 24999 local
nat-list 1 pat group-static-entry tcp 10000 10999 local
nat-list 1 pat group-static-entry tcp 14000 14999 local
nat-list 1 pat group-static-entry tcp 18000 18999 local
nat-list 1 pat static-entry tcp 23 local
nat-list 1 pat group-static-entry tcp 20 21 local
nat-list 1 pat group-static-entry udp 67 68 local
nat-list 1 pat static-entry icmp ping local
!
no ip-share enable
interface ether0.0
ip address dhcp
!
interface ether1.0
ip address 10.1.1.1 255.255.255.0
ip nat-group 1 pat ether0.0
ip dhcp-group 1
    
```

Public IP (PPPoE) + NAT/PAT

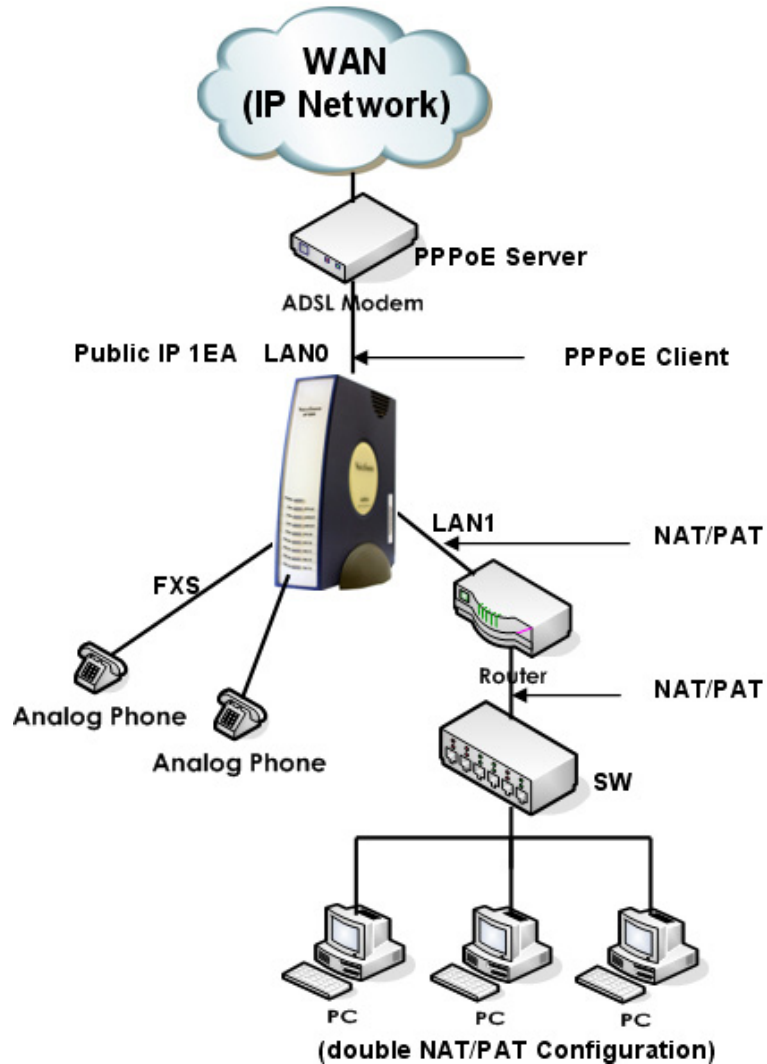

3) Interface ethernet 0 pppoe ip address

```
dhcp-list 1 type server
dhcp-list 1 address server 10.1.1.2 10.1.1.254 255.255.255.0
dhcp-list 1 option dns 10.1.1.1
dhcp-list 1 option router-option 10.1.1.1
!
nat-list 1 pat static-entry tcp 1720 local
nat-list 1 pat static-entry udp 5060 local
nat-list 1 pat group-static-entry udp 22000 22001 local
nat-list 1 pat group-static-entry udp 23000 24999 local
nat-list 1 pat group-static-entry tcp 10000 10999 local
nat-list 1 pat group-static-entry tcp 14000 14999 local
nat-list 1 pat group-static-entry tcp 18000 18999 local
nat-list 1 pat static-entry tcp 23 local
nat-list 1 pat group-static-entry tcp 20 21 local
nat-list 1 pat group-static-entry udp 67 68 local
nat-list 1 pat static-entry icmp ping local
!
no ip-share enable
!
```

Public IP (PPPoE) + NAT/PAT Continue.

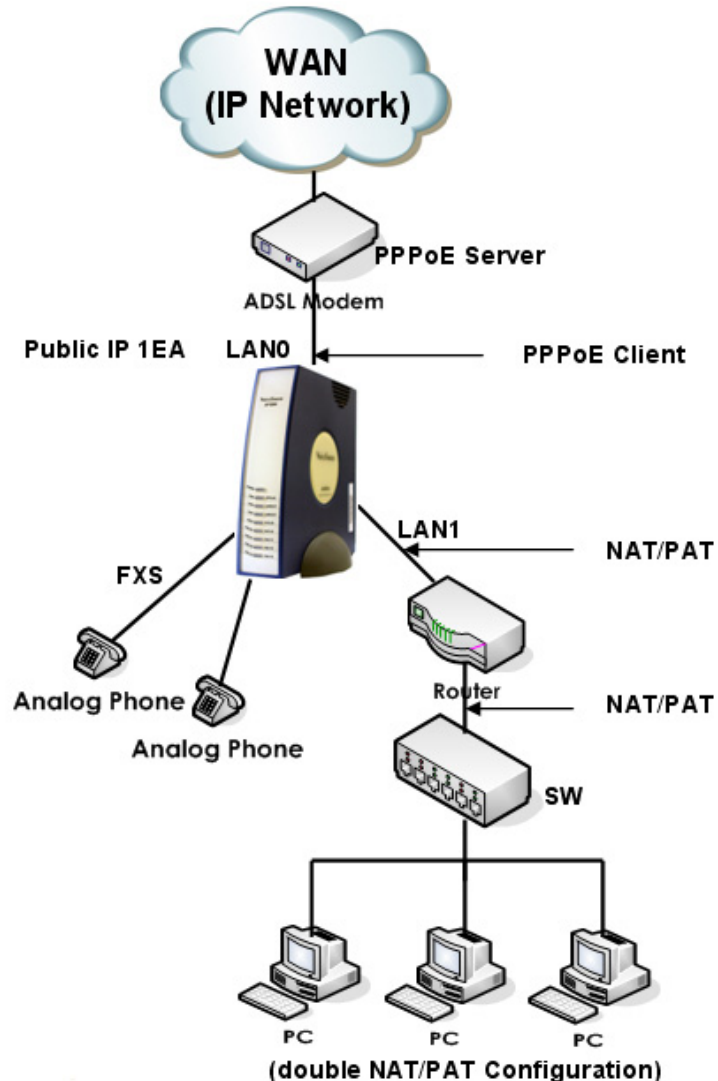

```
interface ether0.0
no ip address
encapsulation pppoe
ppp authentication pap callin
ppp pap sent-username addpac password 12345
ppp echo interval 200
ppp ipcp ms-dns
ppp ipcp default-route
!
interface ether1.0
ip address 10.1.1.1 255.255.255.0
ip nat-group 1 pat ether0.0
ip dhcp-group 1
```

Public IP + IP Share + Cascading Network Diagram

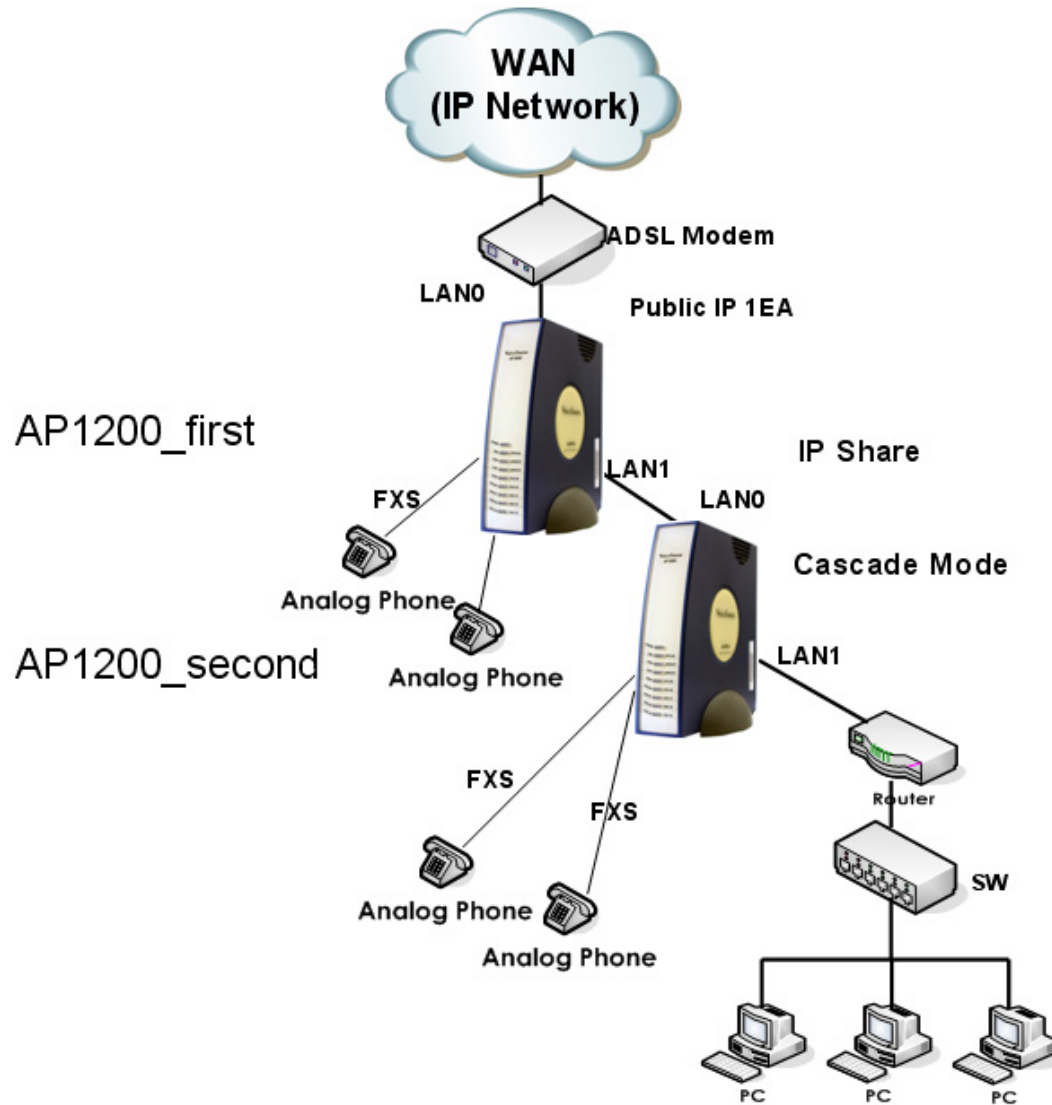

Public IP (static IP)+ IP Share + Cascading : First Terminal CLI

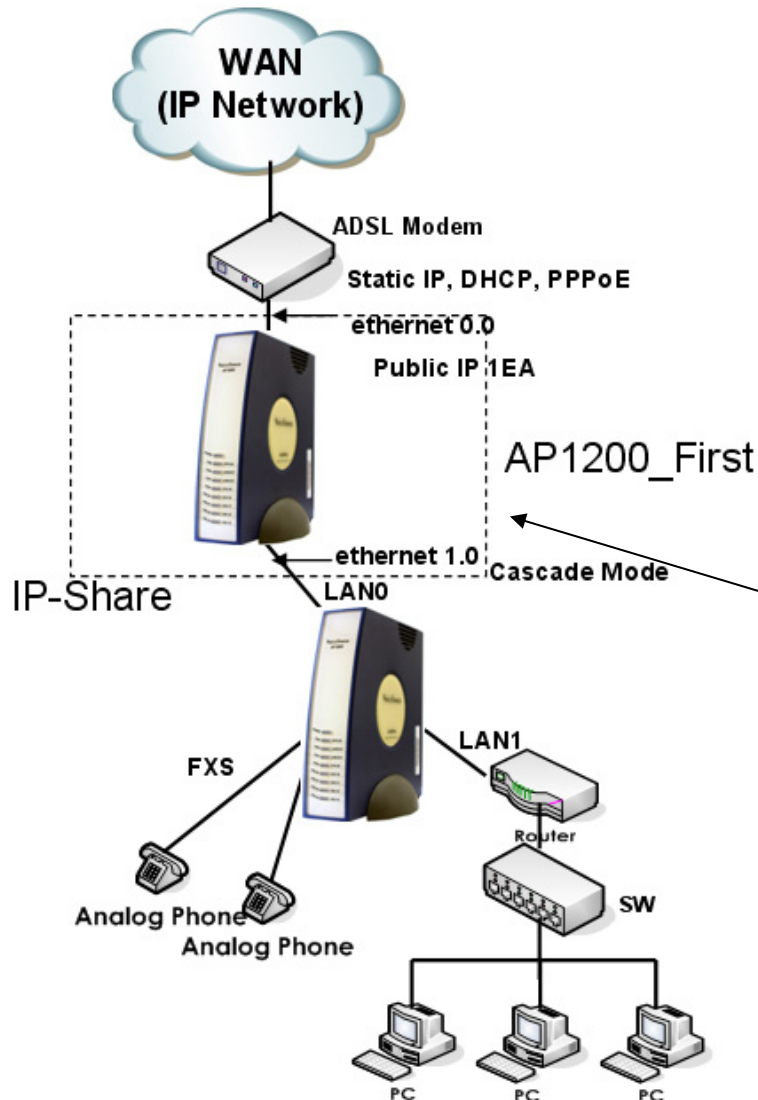

(1) AP1200-First

```

dhcp-list 0 type server
dhcp-list 0 address server interface ether0.0
dhcp-list 0 option dhcp-lease-time 600
dhcp-list 0 option router-option 200.207.75.65
!
dhcp-list 1 type server
dhcp-list 1 address server 10.1.1.2 10.1.1.126 255.255.255.128
!
ip-share enable
ip-share interface net-side ether0.0
ip-share interface local-side ether1.0
ip-share cascade
ip-share sending group-static-entry udp 5061 5062 local-side
ip-share sending group-static-entry udp 23100 23299 local-side
ip-share sending group-static-entry tcp 2000 2003 local-side
ip-share sending group-static-entry tcp 3000 3003 local-side
ip-share sending group-static-entry tcp 8080 8090 local-side
!
    
```

Public IP (static IP)+ IP Share + Cascading : First Terminal CLI (cont...)

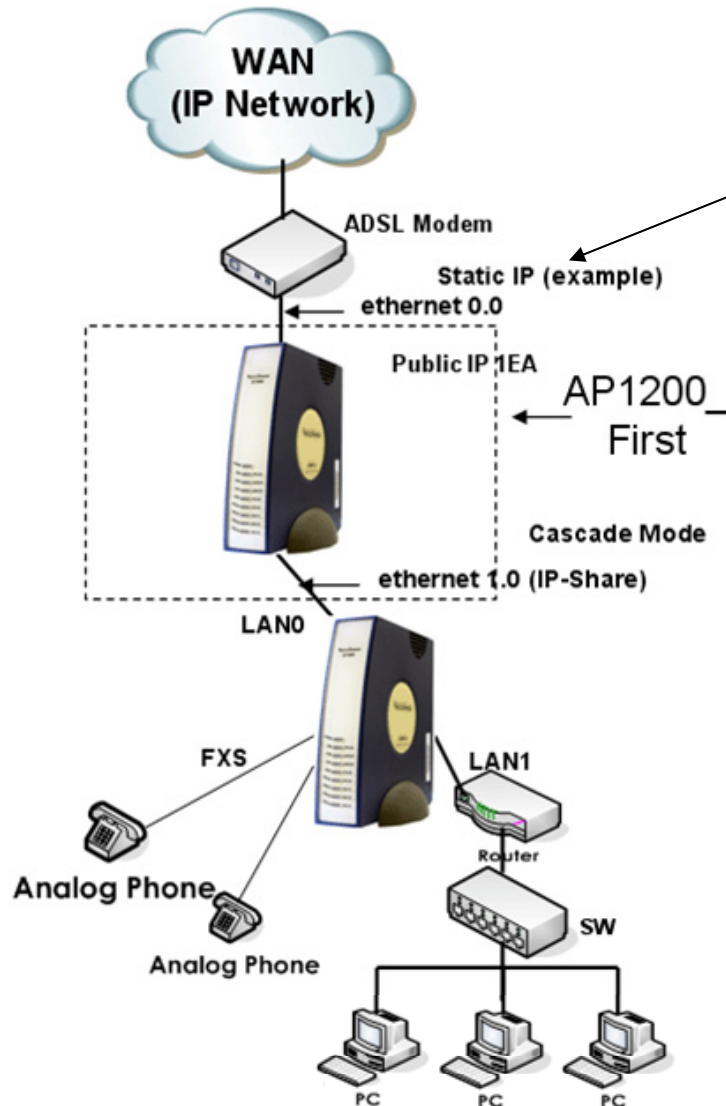

```

interface ether0.0
ip address 200.207.75.91 255.255.255.192
qos-control 100
!
interface ether1.0
no ip address
qos-control 200
ip dhcp-group 0
!
route 0.0.0.0 0.0.0.0 200.207.75.65
!
service-port ftpd 9021
service-port httpd 9080
!
voice service voip
minimize-voip-port service rtp-udp-listen 23000 23099
!
sip-server 216.55.248.39
timeout treg 180
timeout tregtry 60
min-se 60
srv enable
set-local-domain addpac.com
register e164
    
```

Public IP (static IP)+ IP Share + Cascading : Second Terminal CLI

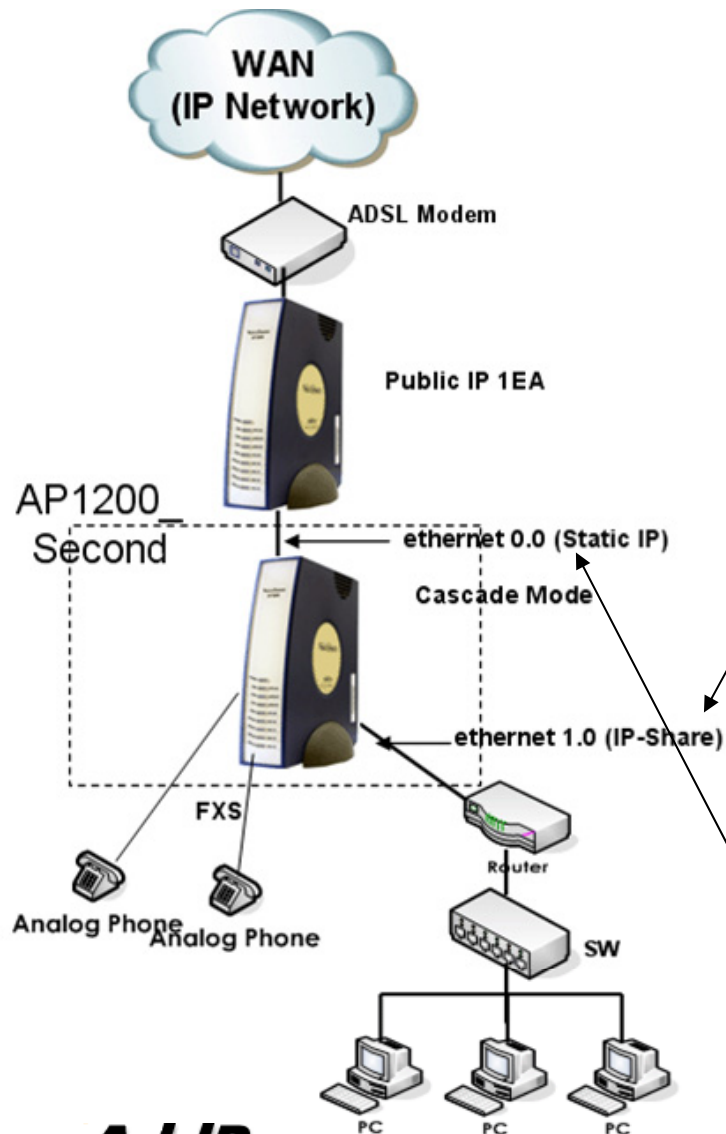

2) AP1200-Second

```

dhcp-list 0 type server
dhcp-list 0 address server interface ether0.0
dhcp-list 0 option dhcp-lease-time 7200
!
dhcp-list 1 type server
dhcp-list 1 address server 10.1.1.2 10.1.1.127 255.255.255.128
dhcp-list 1 option dhcp-lease-time 600
!
!
ip-share enable
ip-share interface net-side ether0.0
ip-share interface local-side ether1.0
ip-share cascade
ip-share sending static-entry udp 5062 local-side
ip-share sending group-static-entry udp 23200 23299 local-side
ip-share sending group-static-entry tcp 3000 3003 local-side
ip-share sending static-entry tcp 8090 local-side
ip-share sending static-entry udp 5060 net-side
ip-share sending group-static-entry udp 23000 23099 net-side
ip-share sending group-static-entry tcp 20 23 net-side
ip-share sending static-entry tcp 80 net-side
!
interface ether0.0
ip address 200.207.75.91 255.255.255.192
qos-control 100
!
    
```

Public IP (static IP)+ IP Share + Cascading : Second Terminal CLI(cont..)

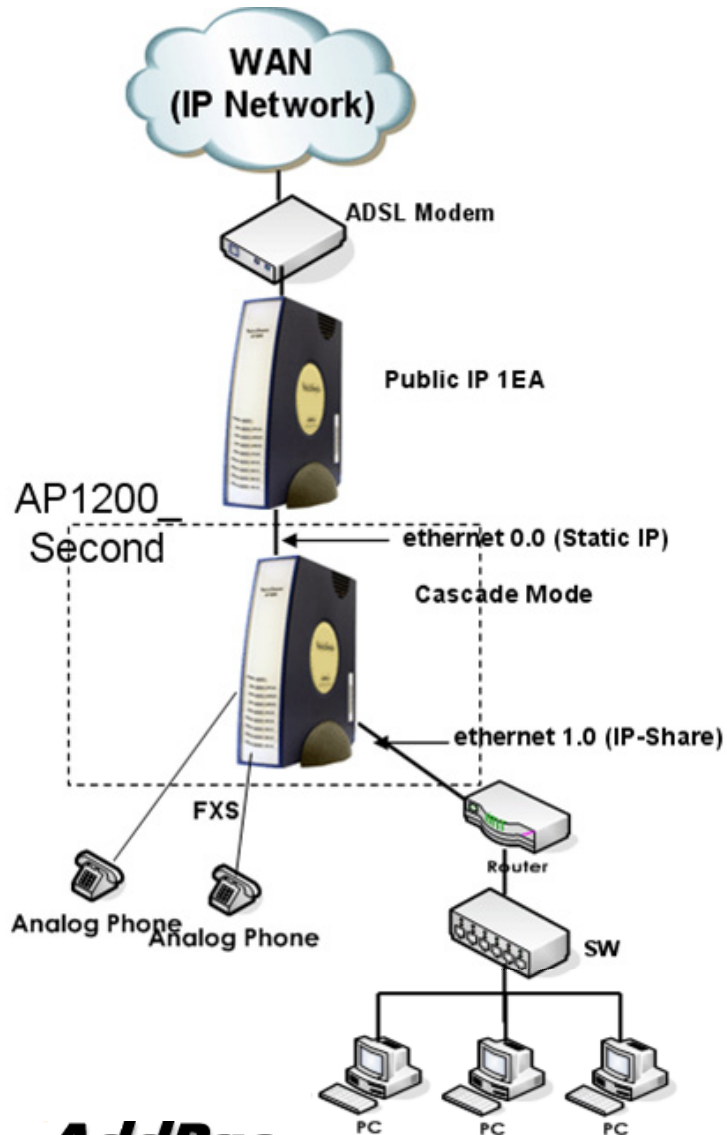

```
interface ether1.0
no ip address
qos-control 200
ip dhcp-group 0
!
snmp name AP200B
no arp reset
!
route 0.0.0.0 0.0.0.0 200.207.75.65
!
service-port ftpd 2001 2000
service-port httpd 8080
service-port telnetd 2003
!
voice service voip
minimize-voip-port service rtp-udp-listen 23100 23199
!
```

Private IP + Bridge Mode Network Diagram Example

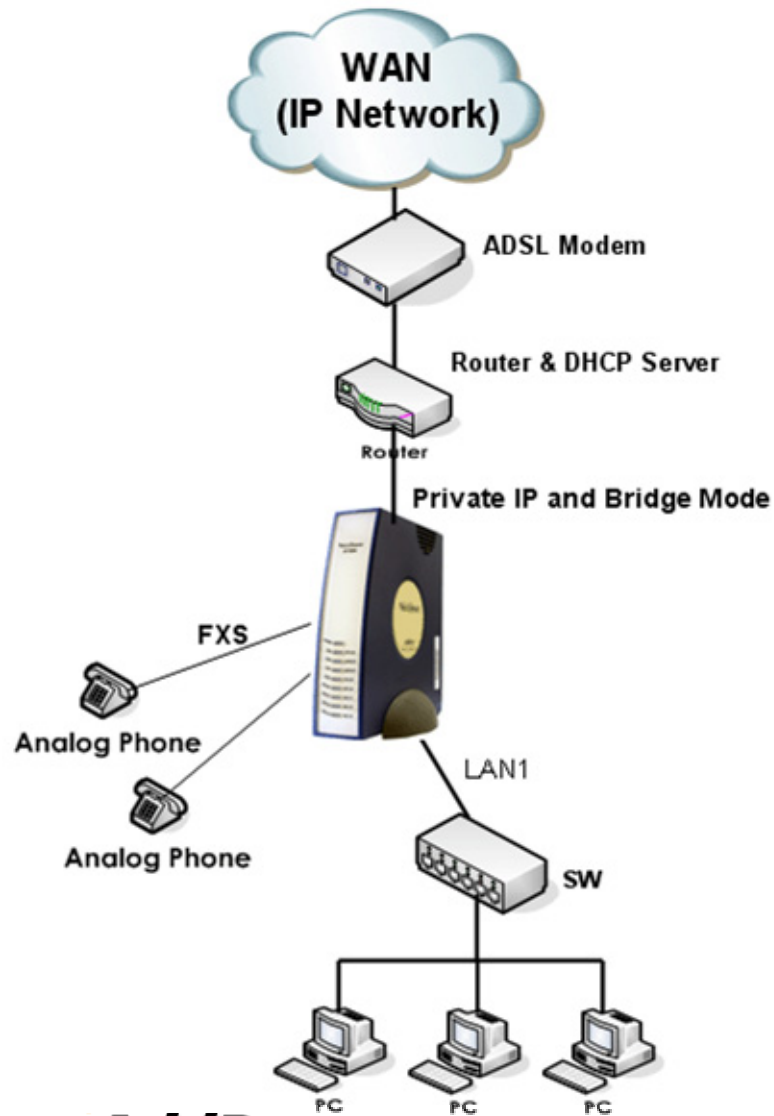

AddPac

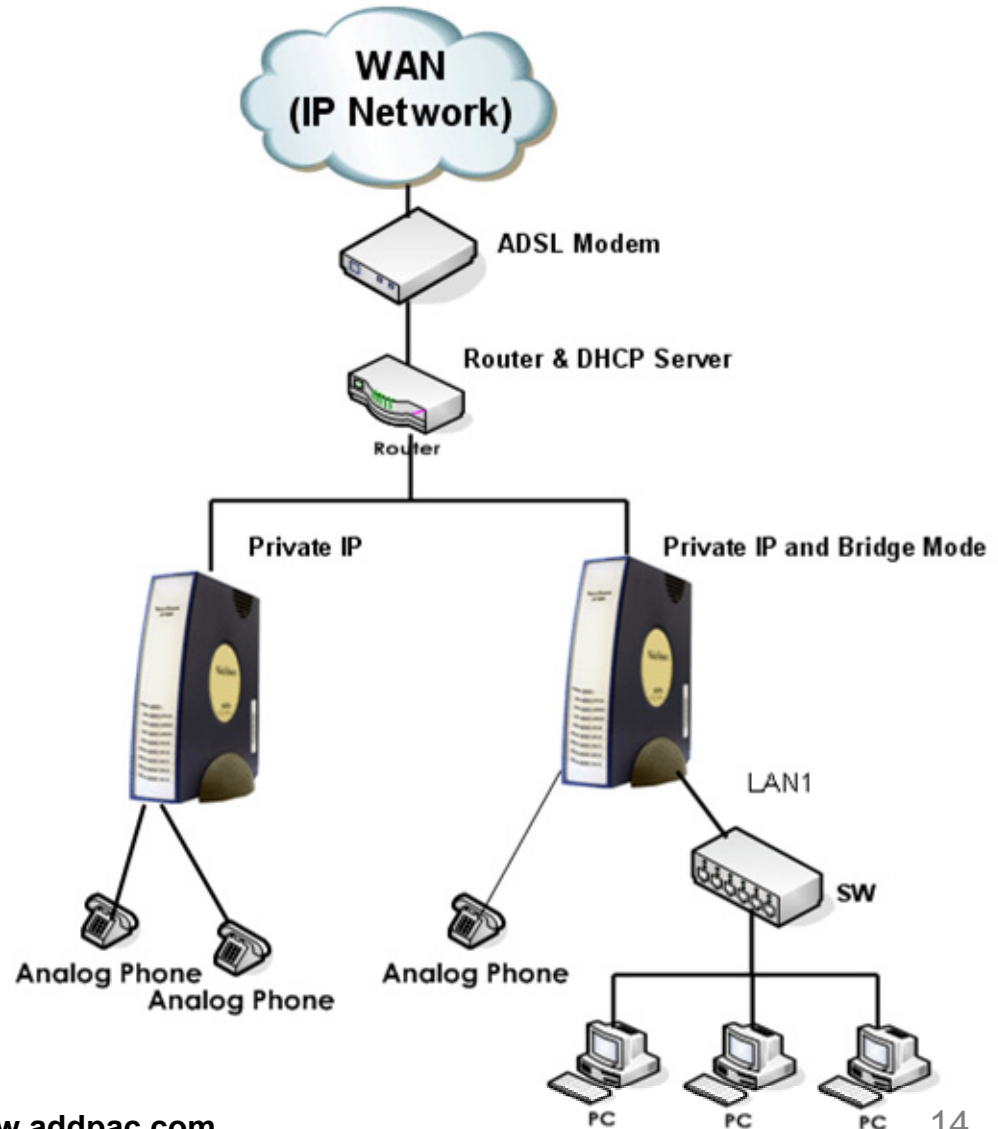

www.addpac.com

Private IP (PPPoE) + Bridge

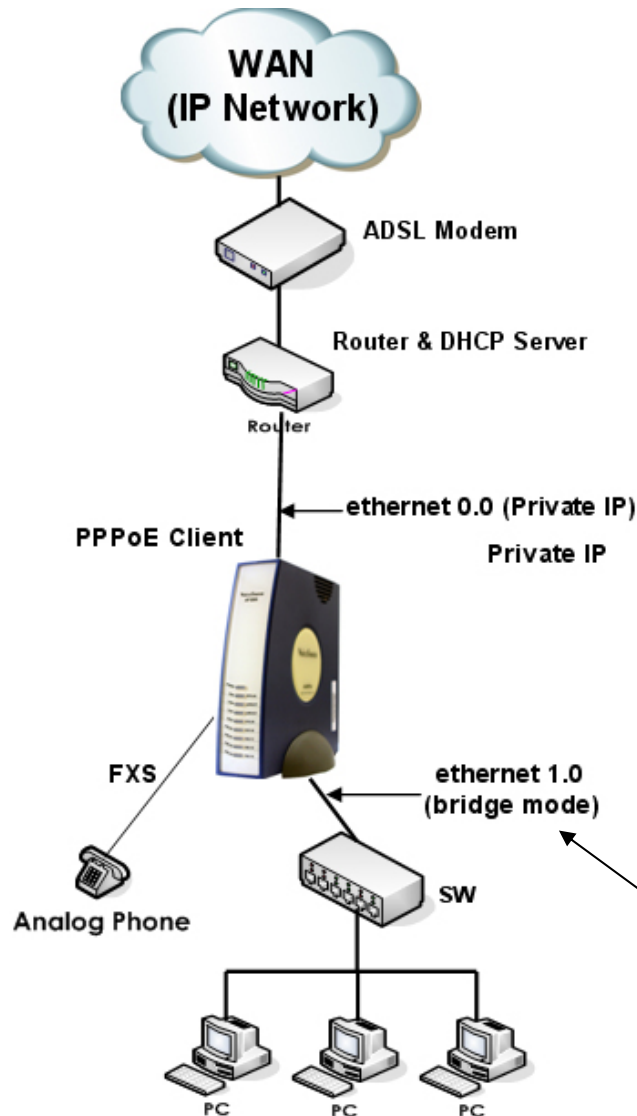

```

1) PPPOE bridge mode
no ip routing
!
no bridge spanning-tree
!
dhcp-list 0 type server
dhcp-list 0 address server interface ether0.0
dhcp-list 0 option dhcp-lease-time 600
!
dhcp-list 1 type server
dhcp-list 1 address server 10.1.1.2 10.1.1.126 255.255.255.128
!
no ip-share enable
!
interface ether0.0
no ip address
encapsulation pppoe
ppp authentication pap callin
ppp pap sent-username addpac password 12345
ppp echo interval 60
ppp ipcp ms-dns
ppp ipcp default-route
line-ctrl promiscuous
bridge
!
interface ether1.0
no ip address
line-ctrl promiscuous
bridge
    
```

Private IP (DHCP) + Bridge

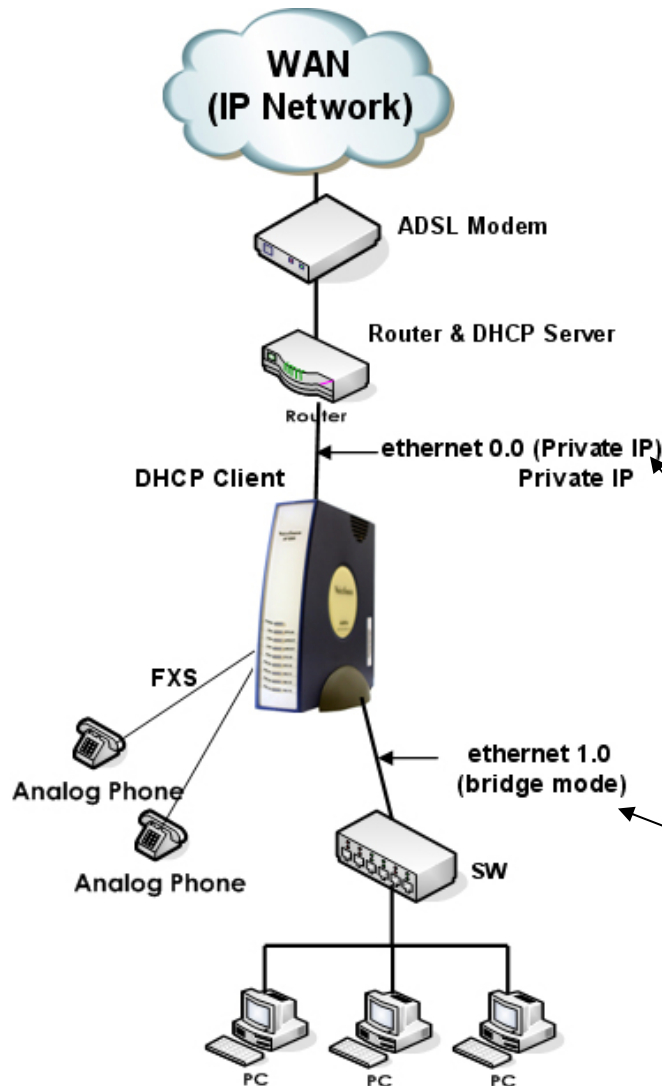

```
2) DHCP bridge
no ip routing
!
no bridge spanning-tree
!
dhcp-list 0 type server
dhcp-list 0 address server interface ether0.0
dhcp-list 0 option dhcp-lease-time 600
!
dhcp-list 1 type server
dhcp-list 1 address server 10.1.1.2 10.1.1.126 255.255.255.128
!
!
no ip-share enable
!
interface ether0.0
ip address dhcp
line-ctrl promiscuous
bridge
!
interface ether1.0
no ip address
line-ctrl promiscuous
bridge
```

AP1200 Analog VoIP Gateway

Thank you!

AddPac Technology Co., Ltd.
Sales and Marketing

Phone +82.2.568.3848 (KOREA)

FAX +82.2.568.3847 (KOREA)

E-mail sales@addpac.com