

SMS Gateway Solution



AddPac

AddPac Technology

Sales and Marketing

www.addpac.com

Contents

- SMS Gateway Service Diagram
- SMS Gateway Series
 - AP-GS3500(36ch)
 - AP-GS2500(16ch)
- 4-Port 3G Module (AP-N1-3G4)
- 4-Port GSM Module (AP-N1-GSM4)
- 4-Port CDMA Module (AP-N1-CDMA4)
- Smart Web Manager for SMS Gateway

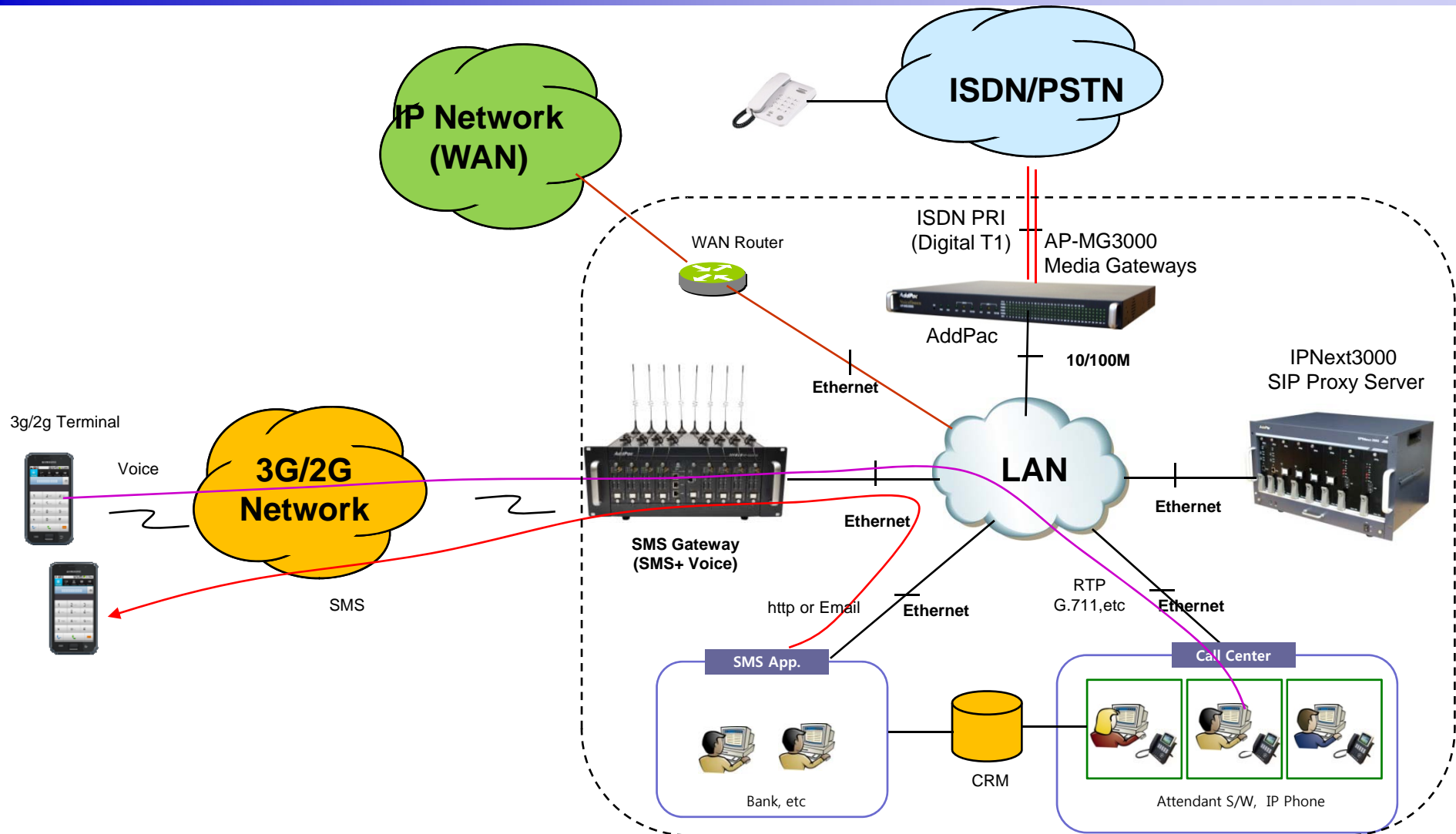

SMS Gateway Service Diagram

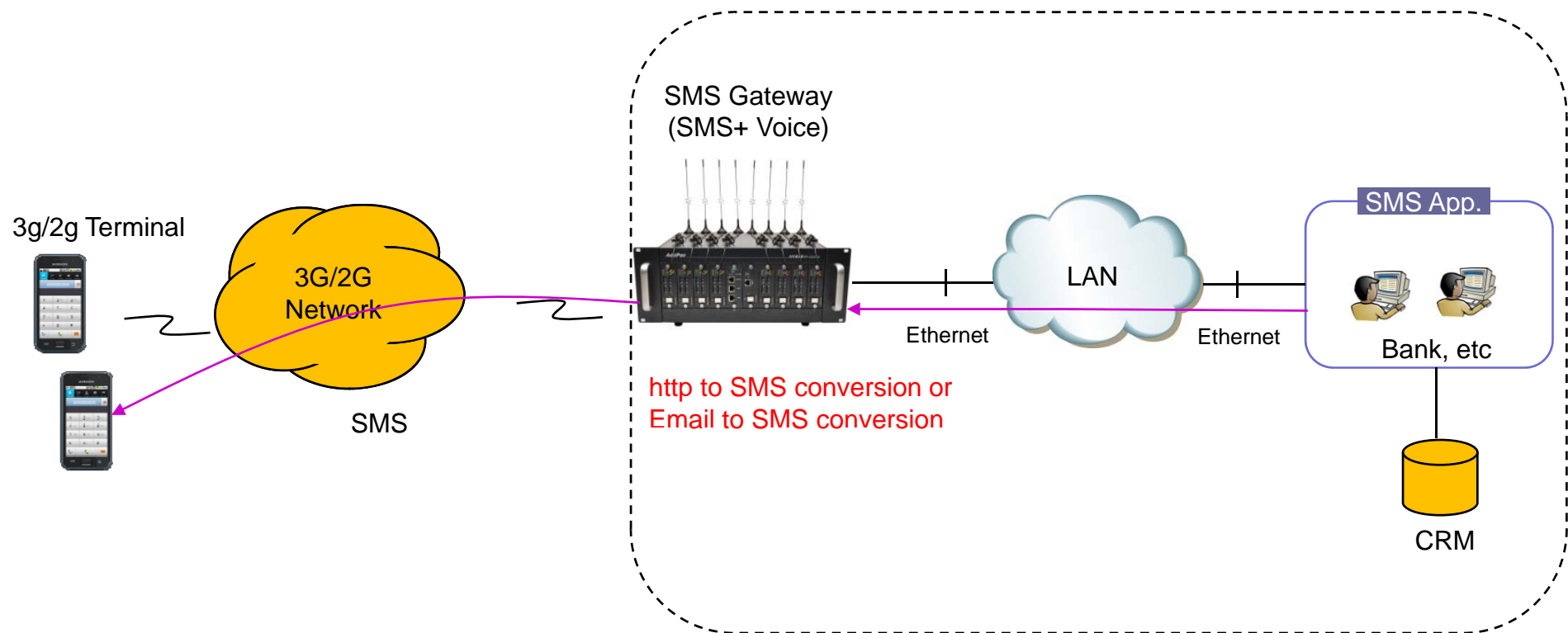

SMS Gateway Service Diagram



SMS Gateway Comparison Table

Model	AP-GS2500 	AP-GS3500 
Available Modules	AP-N1-3G4 AP-N1-GSM4 AP-N1-CDMA4 AP-N1-FXS8 AP-N1-FXO8 AP-N1-FXS4O4 AP-N1-E1	AP-N1-3G4 AP-N1-GSM4 AP-N1-CDMA4 AP-N1-FXS8 AP-N1-FXO8 AP-N1-FXS4O4 AP-N1-E1
Mobile Channel	Up to 16 Channel	Up to 36 Channel
Antenna	One(1) / 4 Channel Module	One(1) / 4 Channel Module
Module Slot	Four(4) Module Slots for 3G/2G, E1/T1 Modules	Nine(9) Module Slots for 3G/2G, E1/T1 Modules
LAN Port	2	2
Console	1	1
Power	Single PSU	Dual PSU (module)

4-Port GSM Module



4-Port GSM Module

AP-N1-GSM4 4-Port GSM Module

- Bearers : GSM + GPRS class 10
- Quad-Band EGSM 850/900/1800/1900MHz
- Normal Sensitivity
 - 850MHz Rx -104 dBm
 - 900MHz Rx -104 dBm
 - 1800MHz Rx -102 dBm
 - 1900MHz Rx -102 dBm
- Tx Performances
 - 850MHz Tx +33 dBm
 - 900MHz Tx +33 dBm
 - 1800MHz Tx +30 dBm
 - 1900MHz Tx +30 dBm
- Power Consumption
 - 17 uA Sleep Mode, 1.7mA Idle Mode, 400mA GPRS class10 (33 dBm)
- Codec
 - FR-EFR-HR-AMR

Hardware Specification

AP-N1-GSM4 4-Port GSM Module

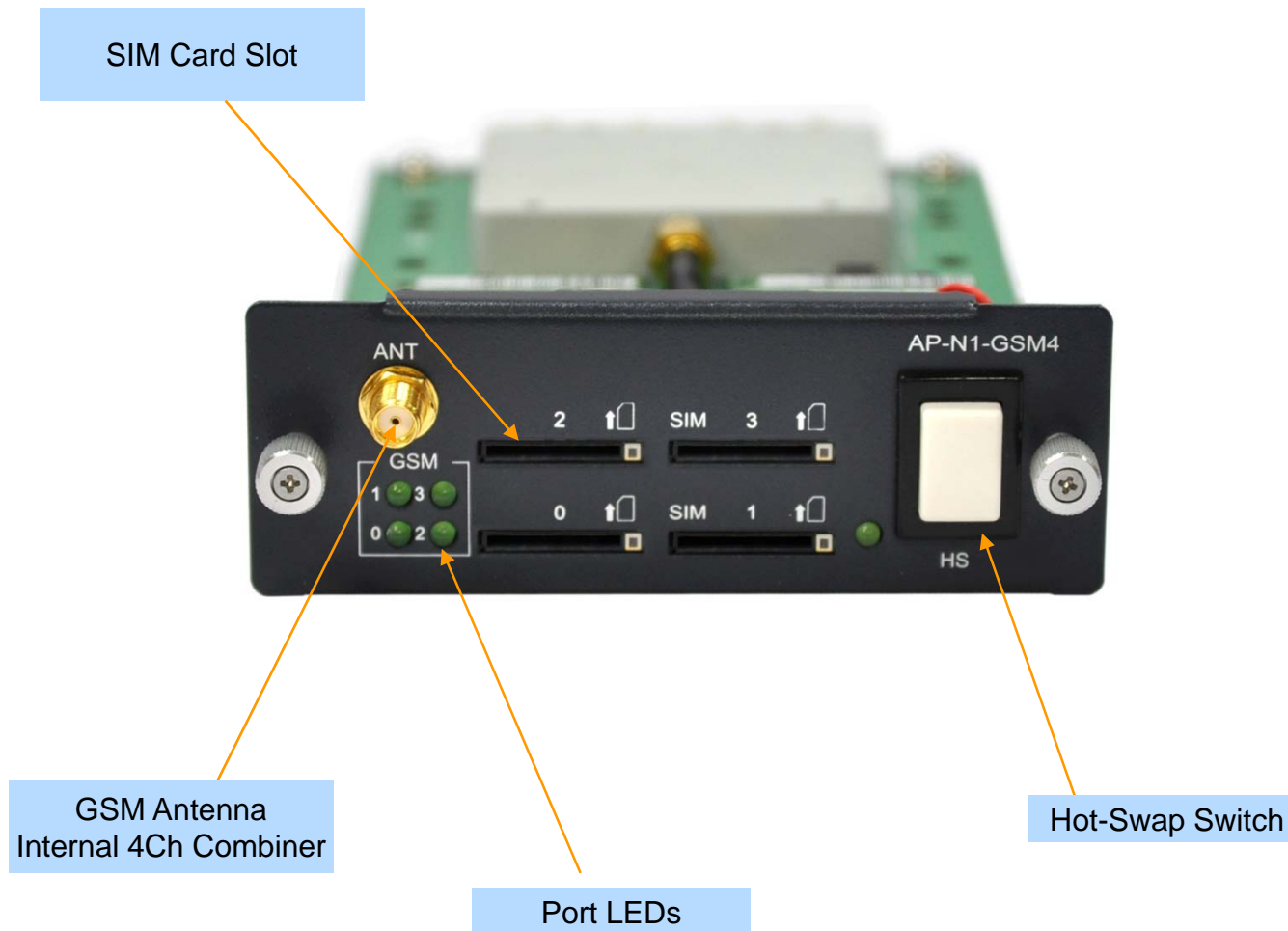

4-Port CDMA Module



4-Port CDMA Module

AP-N1-CDMA4 4-Port CDMA Module

- CDMA2000 1xRTT (IS-2000)-(Dual Band)
- Band class0 (TX : 824~849 MHz / RX : 869~894MHz)
- Band class1 (TX : 1850~1910 MHz / RX : 1930~1990MHz)
- GPS L1 Support
- Output Power : 0.25W CDMA
- CDMA2000 Release A
- IS-637 : Short Message Service (Mobile Originated and Mobile Terminated)
- RUIM(for Asia Pacific Countries)
- 4-Port CDMA Module(AP-N1-CDMA4)
 - 4-Port RUIM Card Slot
 - Port LEDs for Link Activation Indication
 - One(1) CDMA Antenna Interface (Internal 4 Channel Combiner)
 - Hot-Swap Button

Hardware Specification

AP-N1-CDMA4 4-Port CDMA Module

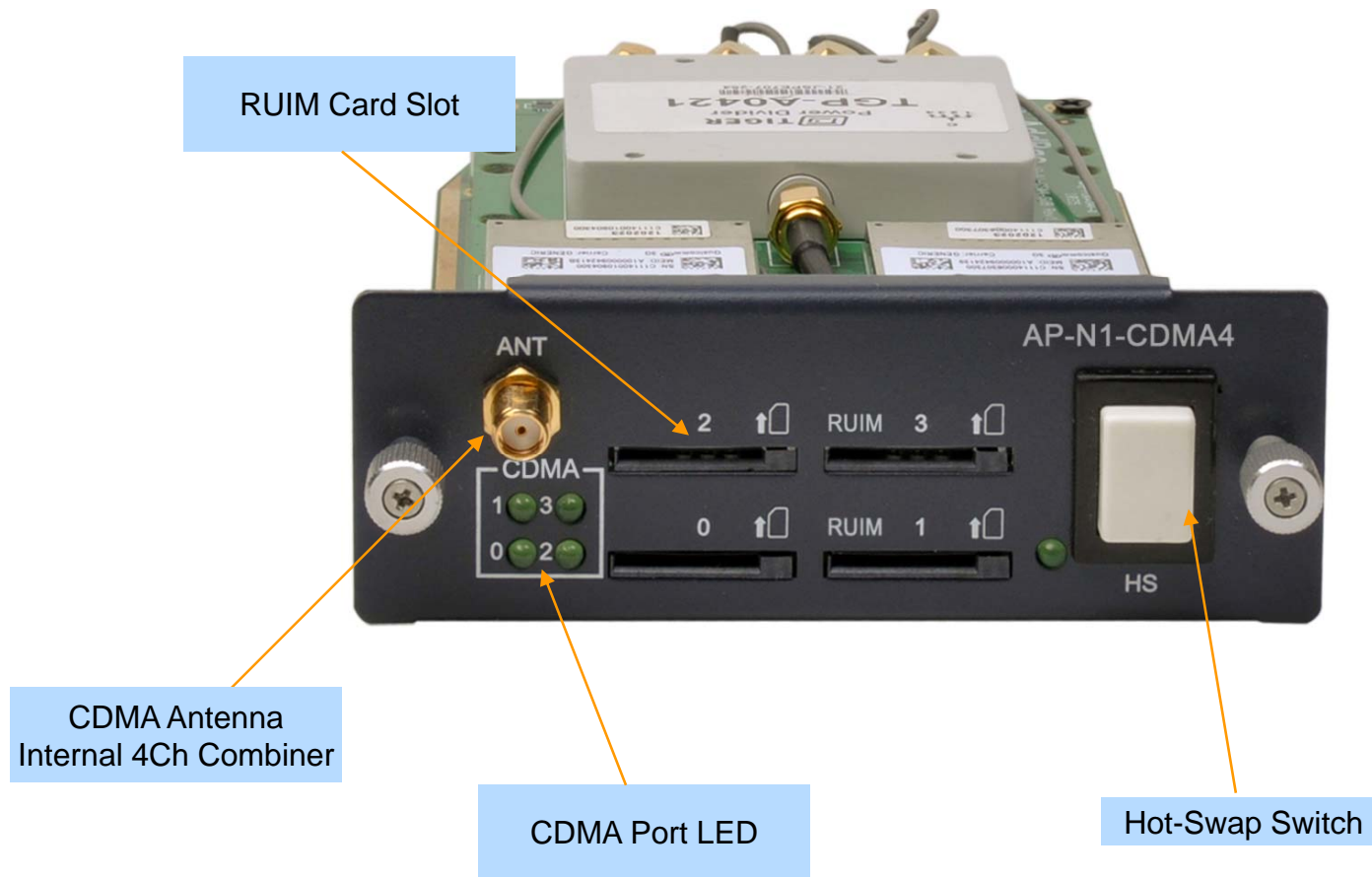

4-Port 3G Module



4-Port 3G Module

AP-N1-3G4 4-Port 3G Module

- WCDMA 2100MHz - Power Class 3 + 24dBm , etc
- GSM 900Mhz – Power Class 4 -2W
- GSM 1800MHz– Power Class 1-1W
- Network Backward Compatibility
- USIM Slot Interface
- Data Transfer Rate
 - HSUPA : Up to 7.2Mbps
 - HSDPA : Up to 3.6Mbps
- 4-Port 3G Module(AP-N1-3G4)
 - 4-Port USIM Card Slot
 - Port LEDs for Link Activation Indication
 - One(1) 3G Antenna Interface (Internal 4 Channel Combiner)
 - Hot-Swap Button

Hardware Specification

AP-N1-3G4 4-Port 3G Module

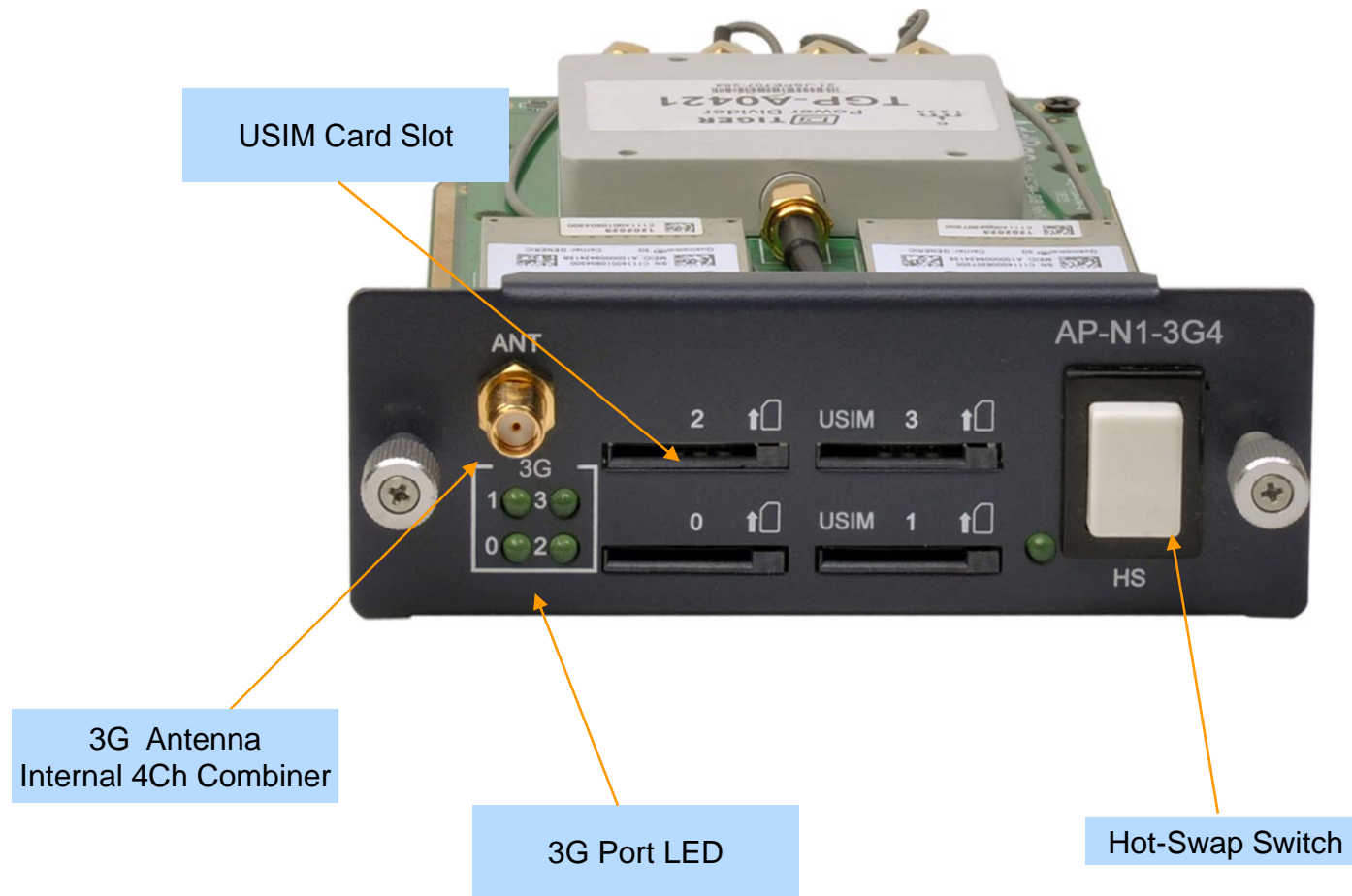



SMS Gateway Series



AP-GS3500 SMS Gateway

Main Features

AP-GS3500 Multi-Port 3G Gateway

- Ten(10) Module Slots for 4-Port 3G Module, 4-Port GSM Module, 8FXS/8FXO Analog Interface (Up to 36-Port 3G, 36-Port GSM, Up to 36-Port CDMA, Digital E1/T1 Module, CPU Module)
- H.323/SIP/MGCP Triple Concurrent Stack Embedded
- High Performance RISC & Programmable DSP Architecture
- G.711/G.726/G.723/G.729, T.38 Fax , VAD, etc
- Powerful Network Protocols (PPPoE, DHCP, Static Routing, etc)
- Two(2)10/100Mbps Fast Ethernet
- One(1) RS-232C Port for Command Line Interface
- Firmware Upgradeable Architecture
- VPMS (VoIP Plug&Play Management System) & NMS for Large Scale Deployment
- Advanced Voice QoS Mechanism
- Powerful Web based Management
- Rack Mountable Chassis with Dual Internal Power Supply

Hardware Specification

AP-GS3500 Multi-Port 3G Gateway

RISC
CPU

High-end
DSP

- RISC Microprocessor Computing Power
- Ten(10) Module Slot for 3G, GSM, CDMA, Analog/Digital Interface
- 4-Port 3G Module(AP-N1-3G4), Hot-Swap
 - One(1) 3G Antenna Interface (4 Channel Combiner), 4-Port USIM Card Slot
- 4-Port GSM Module(AP-N1-GSM4), Hot-Swap
 - One(1) GSM Antenna Interface (4 Channel Combiner), 4-Port SIM Card Slot
- 4-Port CDMA Module(AP-N1-CDMA4), Hot-Swap
 - One(1) CDMA Antenna Interface (4 Channel Combiner), 4-Port RUIM Card Slot
- VoIP Interface Module, Hot-Swap
 - 8-Port FXS Module, Digital E1/T1 Module (AP-N1-FXS8, AP-N1-FXO8, etc)
- Network Interface
 - Two(2) 10/100Mbps Fast Ethernet (RJ45)
- RS232C Console Interface for CLI
- Run LED, LAN LED, Port LEDs
- Dual Power Supply



Hardware Specification

AP-GS3500 Multi-Port 3G Gateway

RISC
CPU

High-end
DSP

Front Side View

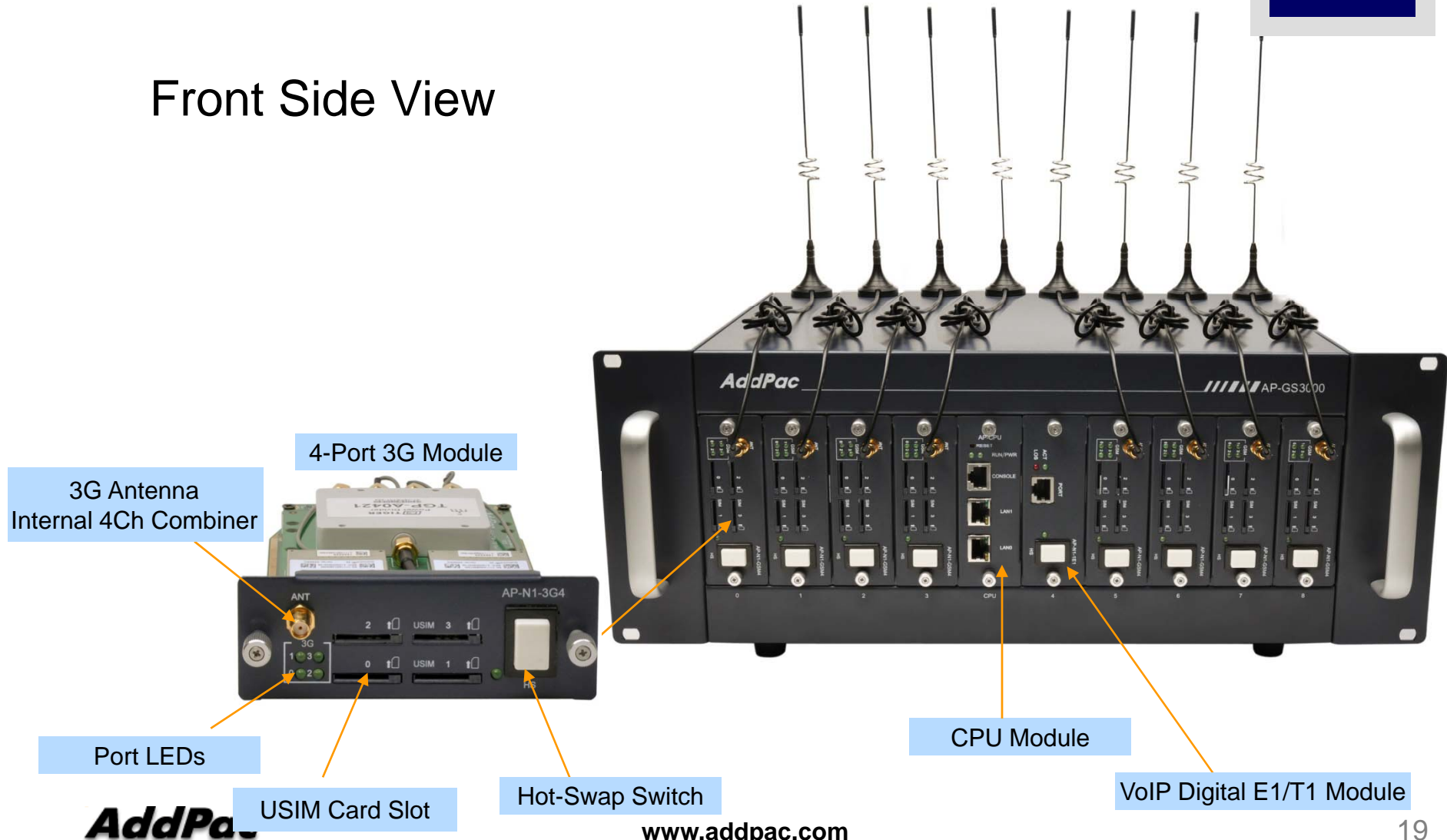

Hardware Specification

AP-GS3500 Multi-Port 3G Gateway

RISC
CPU

High-end
DSP

Back Side View

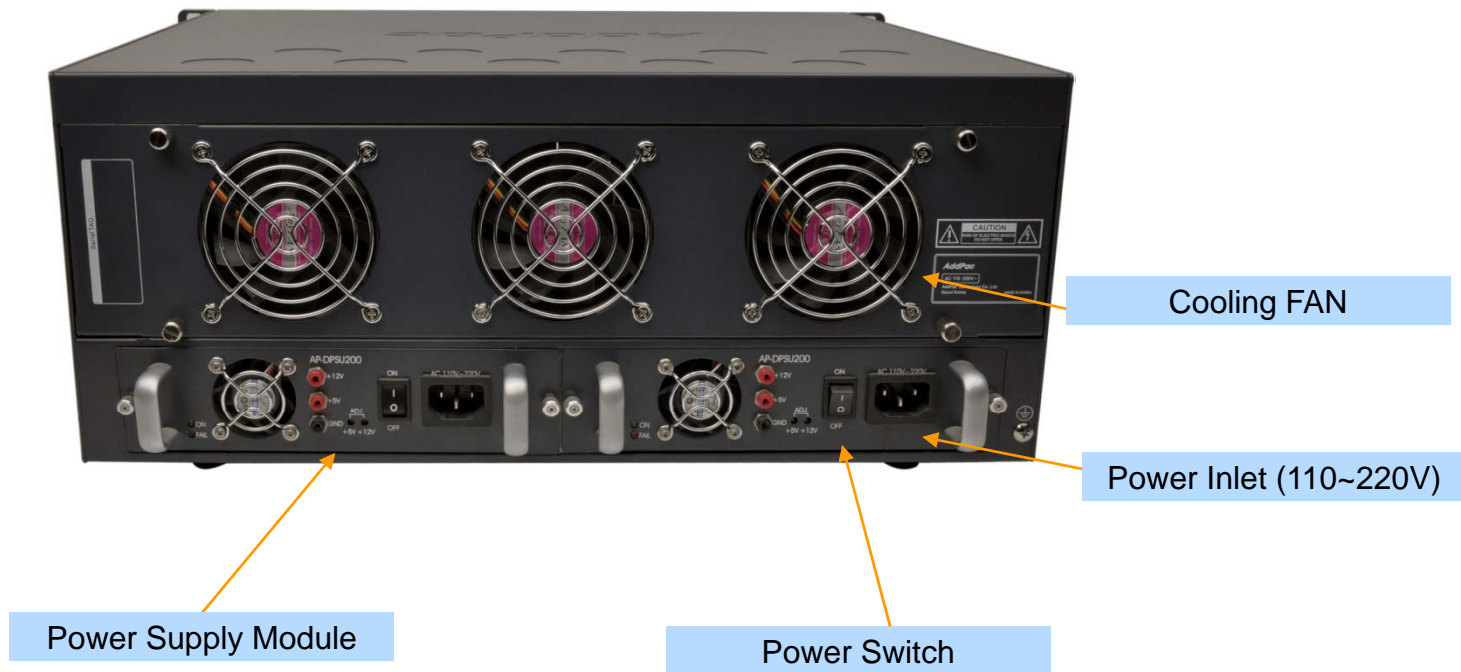

Hardware Specification(Voice Module)

AP-GS3500 Multi-Port 3G Gateway

RISC
CPU

High-end
DSP

AP-N1-3G4 4-Port 3G Module



AP-N1-GSM4 4-Port GSM Module



AP-N1-CDMA4 4-Port CDMA Module



AP-N1-FXS8 8-Port FXS Module



AP-N1-FXO8 8-Port FXO Module



AP-N1-FXS4O4 4-Port FXS&4-Port FXO Module



AP-N1-E1 1-Port Digital E1/T1 Module





AP-GS2500 SMS Gateway

Main Features

AP-GS2500 Multi-Port 3G Gateway

- Four(4) Module Slots for 4-Port 3G Module, 4-Port GSM Module, 8FXS/8FXO Analog Interface (Up to 12-Port 3G +8FXS/8FXO Module, 16-Port 3G)
- H.323/SIP/MGCP Triple Concurrent Stack Embedded
- High Performance RISC & Programmable DSP Architecture
- G.711/G.726/G.723/G.729, T.38 Fax , VAD, etc
- Powerful Network Protocols (PPPoE, DHCP, Static Routing, etc)
- Two(2)10/100Mbps Fast Ethernet
- One(1) RS-232C Port for Command Line Interface
- Firmware Upgradeable Architecture
- VPMS (VoIP Plug&Play Management System) & NMS for Large Scale Deployment
- Advanced Voice QoS Mechanism
- Powerful Web based Management
- Rack Mountable Chassis with Internal Power Supply

Hardware Specification

AP-GS2500 Multi-Port 3G Gateway

- RISC Microprocessor Computing Power
- Four(4) Module Slot for 3G, GSM, CDMA, Analog/Digital Interface
- 4-Port 3G Module(AP-N1-3G4), Hot-Swap
 - One(1) 3G Antenna Interface (4 Channel Combiner), 4-Port USIM Card Slot
- 4-Port GSM Module(AP-N1-GSM4), Hot-Swap
 - One(1) GSM Antenna Interface (4 Channel Combiner), 4-Port SIM Card Slot
- 4-Port CDMA Module(AP-N1-CDMA4), Hot-Swap
 - One(1) CDMA Antenna Interface (4 Channel Combiner), 4-Port RUIM Card Slot
- VoIP Interface Module, Hot-Swap
 - 8-Port FXS Module, Digital E1/T1 Module (AP-N1-FXS8, AP-N1-FXO8, etc)
- Network Interface
 - Two(2) 10/100Mbps Fast Ethernet (RJ45)
- RS232C Console Interface for CLI
- Run LED, LAN LED, Port LEDs
- Internal Power Supply



Hardware Specification

AP-GS2500 Multi-Port 3G Gateway

RISC
CPU

High-end
DSP

Front Side View

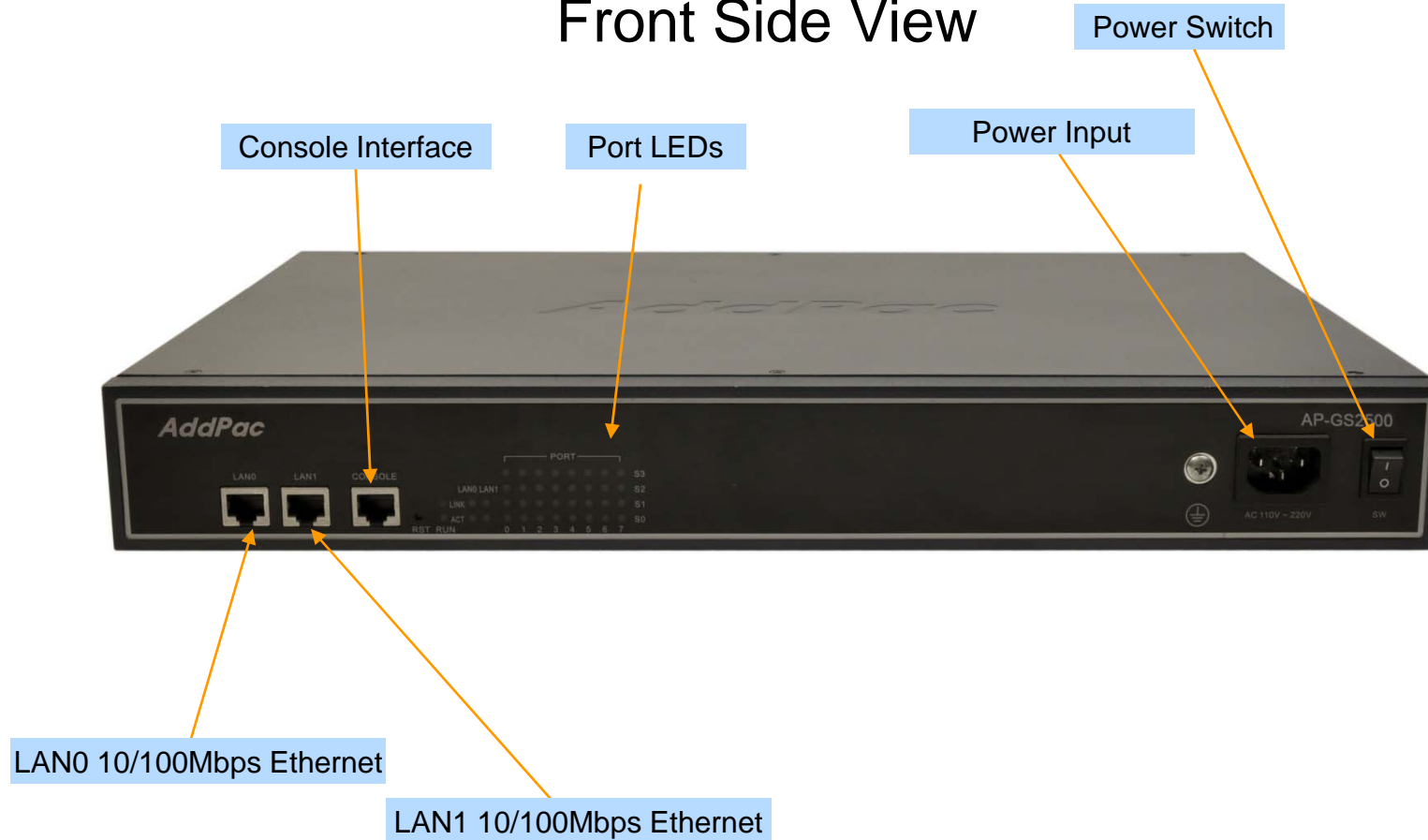

Hardware Specification

AP-GS2500 Multi-Port 3G Gateway

RISC
CPU

High-end
DSP

Back Side View



4-Port 3G Module

3G Antenna
Internal 4Ch Combiner

Port LEDs

USIM Card Slot

Hot-Swap Switch

AddPac

www.addpac.com

Hardware Specification

AP-GS2500 Multi-Port 3G Gateway

RISC
CPU

High-end
DSP

Back Side View



Hardware Specification

AP-GS2500 Multi-Port 3G Gateway

RISC
CPU

High-end
DSP



Hardware Specification(Voice Module)

AP-GS2500 Multi-Port 3G Gateway

AP-N1-3G4 4-Port 3G Module



AP-N1-GSM4 4-Port GSM Module



AP-N1-CDMA4 4-Port CDMA Module



AP-N1-FXS8 8-Port FXS Module



AP-N1-FXO8 8-Port FXO Module



AP-N1-FXS4O4 4-Port FXS&4-Port FXO Module

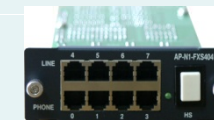

AP-N1-E1 1-Port Digital E1/T1 Module





Smart Web Manager for SMS Gateway

Contents

- Main Page Layout
- System Configuration
 - Network Setup, Language, NAT, PPTP, NTP
- Basic Configuration
 - Protocol, SIP Server , FXS Extension, GSM Extension
 - DTMF/CODEC, VoIP Dial Plan, GSM Dial Plan, Static Routing, Hot Line
- Advanced Configuration
 - Gain/CID, GSM PINs, FAX, Service, Filtering, Security
 - GSM Web Callback, GSM Callback
- Miscellaneous Configuration
 - Call Status, System Status, Alarm Status, GSM Status
 - Call Log, System Log, Ping, BTS Selection, GSM BTS Info
- LCR(Least Cost Routing)
 - Black & White List, Time Interval, Tariff Group, LCR Test
- SMS
 - Inbox, SMS New Message

Main Page Layout

Main Menu
For easy system setup, provide the various menu and category

- System
 - Network Setup
 - Language
 - NAT
 - PPTP
 - NTP
- Basic
 - Protocol
 - Server SIP
 - SIP Registration
 - FXS Extension
 - GSM Extension
 - DTMF/CODEC
 - VoIP Dial Plan
 - GSM Dial Plan
 - Static Route
 - Hot Line
- Advanced
 - Gain & CID
 - GSM PINs
 - Fax
 - Service
 - Filtering
 - Security
 - SNMP
 - WEB Callback
 - GSM Callback

Tool Bar
Provide frequently used tools like as System Update, Configuration Backup, Initialization, Restart, Telnet

Information
Display the current system version and status summary

H/W Version	2.0
SW Version	8.00d
MAC Address	0002.a400.0000
VoIP Protocol	SIP
Voice Interface Module	G(2)S(2)
Registration Status	Registered
Supported Codec List	
Network Information	Static 172.16.9.16
WAN LINK Status	100Mbps FULL Duplex Link UP
LAN LINK Status	Link Down
Current Time	Fri Jan 1 01:49:57 2010
System Startup Time	Fri Jan 1 00:00:00 2010
	0 days 01:49:57
	0

Workspace
Workspace for detailed action

Description
Display the help message if you move mouse over main menu

Information
AddPac Technology
Model : GS1002_G2
H/W Version : 2.0
S/W Version : 8.00d
Smart Web Version : 0.4
Smart Web Build : Mar 24 2010
Voice Interface : G(2)S(2)
Protocol : SIP
Status : Registered
CurrentCalls: 0 Call
Network : Static 172.16.9.16
Mac Address: 0002.a400.0000
Unread Message:
P0:0(0)
P0:1(0)

Description

System – Network Setup

The screenshot shows the 'Network Setup' page in the Smart Web Manager. The page is divided into several sections, each with a radio button for selection. The 'Static IP' section is selected. The 'Static IP' section includes fields for IP Address (172.16.9.16), Network Mask (255.255.0.0), Default Router (172.16.1.1), and DNS Server (Primary and Secondary). The 'PPPoE(ADSL)' section includes fields for Username and Password. The 'DHCP' section is also present. The 'VLAN' section includes a field for ID (0). The 'WAN Link Control' section has radio buttons for 'Auto' and 'Manual', and dropdown menus for Speed (100, 10) and Duplex (full, half). The 'MAC(Hardware) Address' section includes a field for the MAC address. The 'Information' panel on the right shows system details and unread messages. The 'Description' panel on the right provides a detailed explanation of the WAN Link Control settings.

Host Name
Create a representative name for the site to be installed

Static IP
This is static IP mode. Specify the addressed IP from the service provider

PPPoE
This is ADSL mode. This mode is used for addressing IP though authentication from the modem. At this time, the modem must be configured in a way that the device can be authenticated.

DHCP
This is dynamic IP mode which is set at default. The IP can be addressed from the external DHCP server.

VLAN
Configure VLAN mode and ID.

WAN Link
Controls and recognizes WAN port. Specify the connection speed of WAN port. connection automatically.

MAC
Change MAC address of WAN interface. Without address entry, use the basic MAC Address.

Information

AddPac Technology
Model : GS1002_G2
H/W Version : 2.0
S/W Version : 8.00d
Smart Web Version : 0.4
Smart Web Build : Mar 24 2010
Voice Interface
G(2)S(2)
Protocol : SIP
Status : Registered
CurrentCalls : 0 Call
Network : Static 172.16.9.16
Mac Address : 0002.a400.0000
Unread Message:
P0:0(0)
P0:1(0)

Description

This command sets up WAN port. The static IP address is to be assigned to the WAN port. The static IP address can be changed. MAC Address change can be used only when necessary. It is recommended to use the address created by the user not the address of the device

UnRead SMS Messages

System - Language

Smart Web Manager
www.addpac.com

System

- Network Setup
- NTP

Basic

- Protocol
- Server SIP
- SIP Registration
- FXS Extension
- GSM Extension
- DTMF/CODEC
- VoIP Dial Plan
- GSM Dial Plan
- Static Route
- Hot Line

Advanced

- Gain & CID
- GSM PIN

Configure Language

한국어

English

Apply

Information

AddPac Technology
Model : GS1002_G2
HW Version : 2.0
SW Version : 8.00d
Smart Web Version : 0.4
Smart Web Build : Mar 24 2010
Voice Interface
G(2)S(2)
Protocol : SIP
Status : Registered
CurrentCalls : 0 Call
Network : Static 172.16.9.16
Mac Address : 0002.a400.0000
Unread Message:
P0:0(0)
P0:1(0)

Description

Choose the basic language to be applied. English is set at default.

Configure Language
English, Korea

System - NAT

Smart Web Manager
www.addpac.com

System

- Network Setup
- Language
- NAT**
- PPTP
- NTP

Basic

- DTMF/CODEC
- VoIP Dial Plan
- GSM Dial Plan
- Static Route
- Hot Line

Advanced

- Gain & CID
- GSM PINs
- Fax
- Service
- Filtering
- Security

NAT Static Table

IP Protocol	Global Port	Local Address	Local Port	Control
tcp	<input type="text"/>	<input type="text"/>	<input type="text"/>	<input type="button" value="Add"/>

Information

AddPac Technology
Model : GS1002_G2
H/W Version : 2.0
S/W Version : 8.00d
Smart Web Version : 0.4
Smart Web Build : Mar 24 2010
Voice Interface
G(2)S(2)
Protocol : SIP
Status : Unregistered
CurrentCalls: 0 Call
Network : Static 172.16.9.16
Mac Address: 0002.a400.0000
Unread Message:
P0:0(0)
P0:1(0)

Description

When many PCs are connected to LAN, create a table for delivering TCP/UDP port to PC.

NAT Static Table

When many PCs are connected to LAN, create a table for delivering TCP/UDP port to PC

System - PPTP

The screenshot shows the 'Smart Web Manager' interface for configuring PPTP. The main content area is titled 'Tunneling' and contains three sections: 'Mode', 'Source & Destination', and 'Service'. Three yellow callout boxes provide additional context:

- Tunneling Mode:** Configure Tunneling mode. This points to the 'Mode' section where 'None(Disable Tunneling, default)' is selected.
- Tunneling source & destination:** Source LAN port & destination IP. This points to the 'Source' dropdown (FastEthernet0/0) and the 'Destination' text input field.
- Tunneling Service:** Service mode. This points to the 'Service' section where 'Voice and Data Use Tunnel Interface (default)' is selected.

The 'Information' sidebar on the right provides system details:

- AddPac Technology
- Model : GS1002_G2
- H/W Version : 2.0
- S/W Version : 8.00d
- Smart Web Version : 0.4
- Smart Web Build : Mar 24 2010
- Voice Interface: G(2)S(2)
- Protocol : SIP
- Status : Unregistered
- CurrentCalls : 0 Call
- Network : Static 172.16.9.16
- Mac Address : 0002.a400.0000
- Unread Message: P0:0(0), P0:1(0)

System - NTP

System

- Network Setup
- Language
- NAT
- PPTP
- **NTP**

Basic

- Protocol
- Server SIP
- SIP Registration
- FXS Extension
- GSM Extension
- DTMF/CODEC
- VoIP Dial Plan
- GSM Dial Plan
- Static Route

NTP

Enable Disable

Primary Server (Domain Name or IP Address)

Secondary Server (Domain Name or IP Address)

Interval (1~72 hours)

Hours Offset : (-23~23 hours) : (0~60 minute)

Information

AddPac Technology
Model : GS1002_G2
H/W Version : 2.0
S/W Version : 8.00d
Smart Web Version : 0.4
Smart Web Build : Mar 24 2010
Voice Interface
G(2)S(2)
Protocol : SIP
Status : Unregistered
CurrentCalls: 0 Call
Network : Static 172.16.9.16
Mac Address: 0002.a400.0000
Unread Message:
P0:0(0)
P0:1(0)

Description

NTP
Configure NTP server (s) & Options

Basic - Protocol

Smart Web Manager
www.addpac.com

System

- Network Setup
- Language
- NAT
- PPTP
- NTP

Basic

- **Protocol**
- Server SIP
- SIP Registration
- FXS Extension
- GSM Extension
- DTMF/CODEC
- VoIP Dial Plan
- GSM Dial Plan
- Static Route
- Hot Line

Advanced

- Gain & CID
- GSM PINs
- Fax
- Service
- Filtering
- Security
- SNMP
- WEB Callback
- GSM Callback

Miscellaneous

- Call Status
- System Status
- Alarm Status
- GSM Status
- Call Log
- System Log
- Ping
- BTS Selection
- GSM BTS Info

Protocol

SIP(Session Initiation Protocol)

Apply

Configure VoIP signaling protocol SIP , H.323 (optional)

Information

AddPac Technology
Model : GS1002_G2
H/W Version : 2.0
S/W Version : 8.00d
Smart Web Version : 0.4
Smart Web Build : Mar 24 2010
Voice Interface
G(2)S(2)
Protocol : SIP
Status : Unregistered
CurrentCalls: 0 Call
Network : Static 172.16.9.16
Mac Address: 0002.a400.0000
Unread Message:
P0:0(0)
P0:1(0)

Description

Configure the settings of the protocol to be used for VoIP communication

Basic – SIP Server

Smart Web Manager
www.addpac.com

SIP (Session Initiation Protocol)

Use SIP Server Yes No

Primary SIP Server Server address (IP or Domain Name) and Port (default 5060)

Secondary SIP Server Server address (IP or Domain Name) and Port (default 5060)

Local Domain name (SIP userpart of authentication)

SIP Signaling Port (default 5060, between 1 to 65535)

Register Expiration (in seconds, default 60, between 10 to 86400)

Session Re-Fresh INVITE UPDATE

Session Expire Time (in seconds, default 1800, between 30 to 86400, 0 = disable)

Apply

SIP Server
Primary & Secondary server,
Local domain name,
SIP Signaling Port (**reboot necessary**)
Timer
* register expire
* session refresh
* session expire

Information
AddPac Technology
Model : GS1002_G2
H/W Version : 2.0
S/W Version : 8.00d
Smart Web Version : 0.4
Smart Web Build : Mar 24 2010
Voice Interface
G(2)S(2)
Protocol : SIP
Status : Unregistered
CurrentCalls : 0 Call
Network : Static 172.16.9.16
Mac Address : 0002.a400.0000
Unread Message:
P0:0(0)
P0:1(0)

Description
Configure the settings for SIP.
Contact your service provider
for the settings

Basic – FXS Extension

Smart Web Manager
www.addpac.com

System

- Network Setup
- Language
- NAT
- PPTP
- NTP

Basic

- Protocol
- Server SIP
- SIP Registration
- **FXS Extension**
- GSM Extension

Advanced

- Gain & CID
- GSM PINs
- Fax
- Service
- Filtering
- Security
- SNMP
- WEB Callback
- GSM Callback

Miscellaneous

- Call Status
- System Status
- Alarm Status
- GSM Status
- Call Log
- System Log
- Ping
- BTS Selection
- GSM BTS Info

FXS Extension

Port Information

Port	P0	P1	P2	P3
SLOT0	GSM	GSM	FXS	FXS

FXS Extension Configuration

Index	Port	Numbers	Preference	HuntStop	Select
0	0/2	1234	0	0	<input type="checkbox"/>

Information

AddPac Technology
Model : GS1002_G2
H/W Version : 2.0
S/W Version : 8.00d
Smart Web Version : 0.4
Smart Web Build : Mar 24 2010
Voice Interface
G(2)S(2)
Protocol : SIP
Status : Unregistered
CurrentCalls : 0 Call
Network : Static 172.16.9.16
Mac Address : 0002.a400.0000
Unread Message:
P0:0(0)
P0:1(0)

Description

Set up for using FXS port to extension number (forwarding No)

Port Information
voice port type & physical port

FXS Extension
Configure phone-number for using inter-office Preference (0 : highest)

Basic – GSM Extension

Smart Web Manager
www.addpac.com

System

- Network Setup
- Language
- NAT
- PPTP

System

- Server SIP
- SIP Registration
- FXS Extension
- GSM Extension**

Advanced

- Gain & CID
- GSM PINs
- Fax
- Service
- Filtering
- Security
- SNMP
- WEB Callback
- GSM Callback

Miscellaneous

- Call Status
- System Status
- Alarm Status
- GSM Status
- Call Log
- System Log
- Ping
- BTS Selection
- GSM BTS Info

GSM Extension

Port Information

Port	P0	P1	P2	P3
SLOT0	GSM	GSM	FXS	FXS

GSM Extension Configuration

Index	Port	Numbers	Preference	HuntStop	Select
0	0/0	T	0	X	<input type="checkbox"/>

GSM Extension with Translation

Port	Destination Pattern	Digits to Insert	Number of Digits to Delete
P0:0	33	8	1
P0:1			0

Information

AddPac Technology
Model : GS1002_G2
H/W Version : 2.0
S/W Version : 8.00d
Smart Web Version : 0.4
Smart Web Build : Mar 24 2010
Voice Interface
G(2)S(2)
Protocol : SIP
Status : Unregistered
CurrentCalls : 0 Call
Network : Static 172.16.9.16
Mac Address: 0002.a400.0000
Unread Message:
P0:0(0)
P0:1(0)

Description

Set up for using GSM port to extension number (forwarding No)

Port Information
voice port type & physical port

GSM Extension
Configure GSM phone-number for receiving a call (usually 'T' is used for each port)

GSM Extension with Translation
Used to GSM callback

- The Received CID is not real serving number.
- The specified translation rule is applied.

Basic – DTMF/CODEC

CODEC
Configure voice codec preference
(g711a, g711u, g729, g7231, g726)

DTMF
Configure DTMF relay method
(in-band, RFC2833, out-of-band, CISCO type out-of-band)

Smart Web Manager
www.addpac.com

System

- Network Setup
- Language

Basic

- Protocol
- Server SIP
- SIP Registration
- FXS Extension
- GSM Extension
- **DTMF/CODEC**
- VoIP Dial Plan
- GSM Dial Plan
- Static Route
- Hot Line

Advanced

- Gain & CID
- GSM PINs
- Fax
- Service
- Filtering
- Security
- SNMP
- WEB Callback
- GSM Callback

Miscellaneous

- Call Status
- System Status
- Alarm Status
- GSM Status
- Call Log
- System Log
- Ping
- BTS Selection
- GSM BTS Info

DTMF/CODEC

Voice CODEC

Preference 1	None
Preference 2	None
Preference 3	None
Preference 4	None
Preference 5	None
Preference 6	None

DTMF Relay mode

- DTMF relay by In-band voice
- DTMF relay by RTP payload defined by RFC 2833
- DTMF relay by Out-of-band signal
- DTMF relay by Cisco out-of-band signal

Information

AddPac Technology
Model : GS1002_G2
H/W Version : 2.0
S/W Version : 8.00d
Smart Web Version : 0.4
Smart Web Build : Mar 24 2010
Voice Interface
G(2)S(2)
Protocol : SIP
Status : Unregistered
CurrentCalls: 0 Call
Network : Static 172.16.9.16
Mac Address: 0002.a400.0000
Unread Message:
P0:0(0)
P0:1(0)

Description

Configure the settings for GSM Dial Plan and Prefix table

Basic – VoIP Dial Plan

VoIP PLAN

Configure translation rule for VOIP Peer.
 - first, 'Number of Digits to Delete' option is applied.

- second, 'Digits to Insert' option is applied.

(ex) Origin called Number = 123456
 Number of Digits to Delete = 2
 Digits to Insert = "88"

 result = 883456

Smart Web Manager
www.addpac.com

System

- Network Setup
- Language
- NAT
- PPTP
- NTP

VoIP Dial Plan / Prefix

Plan Table

Index	Digits to Insert	Number of Digits to Delete	Digit Pattern	Control
0	2	0	T	<input type="checkbox"/>

Prefix Table

Index	Prefix	PlanIndex	Control
0	T	2	<input type="checkbox"/>

Information

AddPac Technology
 Model : GS1002_G2
 H/W Version : 2.0
 S/W Version : 8.00d
 Smart Web Version : 0.4
 Smart Web Build : Mar 24 2010
 Voice Interface
 G(2)S(2)
 Protocol : SIP
 Status : Unregistered
 CurrentCalls: 0 Call
 Network : Static 172.16.9.16
 Mac Address: 0002.a400.0000
 Unread Message:
 P0:0(0)
 P0:1(0)

Description

Configure the settings for the outbound call of main/remote and incoming E1 and routing

Gain & CID

- GSM PINs
- Fax
- Service
- Filtering
- Security
- SNMP
- WEB Callback
- GSM Callback

Miscellaneous

- Call Status
- System Status
- Alarm Status
- GSM Status
- Call Log
- System Log
- Ping
- BTS Selection
- GSM BTS Info

Prefix Table

Configure VoIP Peer with translation rule.
 (Serviced by SIP SERVER)

Basic – GSM Dial Plan

Smart Web Manager
www.addpac.com

System

- Network Setup
- Language
- NAT
- PPTP
- NTP

Port Information
voice port type & physical port

Port	P0	P1	P2	P3
SLOT0	GSM	GSM	FXS	FXS

Plan Table

Index	Digits to Insert	Number of Digits to Delete	Digit Pattern	Control
0	1	1	2T	<input type="checkbox"/>

Prefix Table

Index	Prefix	2nd Prefix	PlanIndex	Slot/Port	Control
0	33	2T	0	0/0	<input type="checkbox"/>

Information

AddPac Technology
Model : GS1002_G2
HW Version : 2.0
SW Version : 8.00d
Smart Web Version : 0.4
Smart Web Build : Mar 24 2010
Voice Interface
G(2)S(2)
Protocol : SIP
Status : Unregistered
CurrentCalls : 0 Call
Network : Static 172.16.9.16
Mac Address : 0002.a400.0000
Unread Message:
P0:0(0)
P0:1(0)

Description

Hot Line Setup

VoIP PLAN
Configure translation rule for GSM Peer.
- first, 'Number of Digits to Delete' option is applied.
- second, 'Digits to Insert' option is applied.

(ex) Origin called Number = 123456
Number of Digits to Delete = 2
Digits to Insert = "88"

result = 883456

Prefix Table
Configure GSM Peer with translation rule.

Miscellaneous

- WEB Callback
- GSM Callback
- Call Status
- System Status
- Alarm Status
- GSM Status
- Call Log
- System Log
- Ping
- BTS Selection
- GSM BTS Info

Basic – Static Route

Smart Web Manager
www.addpac.com

System

- Network Setup
- Language
- NAT
- PPTP
- NTP

Basic

- Protocol
- Server SIP
- SIP Registration
- FXS Extension
- GSM Extension
- DTMF/CODEC
- VoIP Dial Plan
- GSM Dial Plan
- **Static Route**
- Hot Line

Advanced

- Gain & CID
- GSM PINs
- Fax
- Service
- Filtering
- Security
- SNMP
- WEB Callback
- GSM Callback

Miscellaneous

- Call Status
- System Status
- Alarm Status
- GSM Status
- Call Log
- System Log
- Ping
- BTS Selection
- GSM RTS Info

Static Route

Set Remote Site Call(5-digit number is set to begin *2->*2...)

No	Remote Site IP	Prefix	Insert Digit	Delete Digit	Name of Remote Site	Answer Addr	Control
0	172.16.1.1	2...	172.16.9.16	0	Factory	T	<input type="checkbox"/>
*	<input type="text"/>	<input type="text"/>	<input type="text"/>	<input type="text"/>	<input type="text"/>	<input type="text"/>	<input type="checkbox"/>

Information

AddPac Technology
Model : GS1002_G2
H/W Version : 2.0
S/W Version : 8.00d
Smart Web Version : 0.4
Smart Web Build : Mar 24 2010
Voice Interface
G(2)S(2)
Protocol : SIP
Status : Unregistered
CurrentCalls : 0 Call
Network : Static 172.16.9.16
Mac Address : 0002.a400.0000
Unread Message:
P0:0(0)
P0:1(0)

Description

Static Route
Configure Static VoIP Peer for using Inter-Office .
(Already, I know IP & phone-number)

Basic – Hot Line

Smart Web Manager
www.addpac.com

Hot Line

Hot Line Configuration

Port	Hot Line Number	Digit Input Timeout <0~10 sec>
S0P0(G)	<input type="text"/>	n.a.
S0P1(G)	<input type="text"/>	n.a.
S0P2(S)	8888	5
S0P3(S)	<input type="text"/>	<input type="text"/>

Apply

Hot Line
- Used as baby-call(Connection PLAR)
- Timer (FXS port only : No Digit event is occurred for configured timer value, Auto-Dialing will be started)

Information
AddPac Technology
Model : GS1002_G2
H/W Version : 2.0
S/W Version : 8.00d
Smart Web Version : 0.4
Smart Web Build : Mar 24 2010
Voice Interface
G(2)S(2)
Protocol : SIP
Status : Unregistered
CurrentCalls: 0 Call
Network : Static 172.16.9.16
Mac Address: 0002.a400.0000
Unread Message:
P0:0(0)
P0:1(0)

Description

Advanced – Gain & CID

Smart Web Manager
www.addpac.com

System

- Network Setup
- Language
- NAT
- PPTP
- NTP

Basic

- Protocol
- Server SIP
- SIP Registration
- FXS Extension
- GSM Extension
- DTMF/CODEC
- VoIP Dial Plan
- GSM Dial Plan
- Static Route
- Hot Line

Advanced

- Gain & CID**
- GSM PINs
- Fax
- Service
- Filtering
- Security
- SNMP
- WEB Callback
- GSM Callback

Miscellaneous

- Call Status
- System Status
- Alarm Status
- GSM Status
- Call Log
- System Log
- Ping
- BTS Selection
- GSM RTS Info

Gain

Port	Port Type	InputGain	OutputGain	Caller ID
P0:0	GSM	0	0	<input checked="" type="checkbox"/>
P0:1	GSM	0	0	<input checked="" type="checkbox"/>
P0:2	FXS	0	0	<input checked="" type="checkbox"/>
P0:3	FXS	0	0	<input checked="" type="checkbox"/>

Apply

Information

AddPac Technology
Model : GS1002_G2
H/W Version : 2.0
S/W Version : 8.00d
Smart Web Version : 0.4
Smart Web Build : Mar 24 2010
Voice Interface
G(2)S(2)
Protocol : SIP
Status : Unregistered
CurrentCalls: 0 Call
Network : Static 172.16.9.16
Mac Address: 0002.a400.0000
Unread Message:
P0:0(0)
P0:1(0)

Description

Adjust the input voice volume from FXS/FXO/E1/E&M to DSP and the output volume from DSP to the phone or PSTN line;

Gain & CID
Configure Input-gain, output-gain and caller-ID.

Advanced – GSM PINs

Smart Web Manager
www.addpac.com

GSM PINs

PINs ⓘ

Port	PIN for SIM card
P0:0	<input type="text"/>
P0:1	<input type="text"/>

GSM PIN
Configure GSM PIN(Personal Identification Number)

Information

AddPac Technology
Model : GS1002_G2
H/W Version : 2.0
S/W Version : 8.00d
Smart Web Version : 0.4
Smart Web Build : Mar 24 2010
Voice Interface
G(2)S(2)
Protocol : SIP
Status : Unregistered
CurrentCalls: 0 Call
Network : Static 172.16.9.16
Mac Address: 0002.a400.0000
Unread Message:
P0:0(0)
P0:1(0)

Description

Configure GSM PINs

Advanced - Fax

Smart Web Manager
www.addpac.com

System

- Network Setup
- Language
- NAT
- PPTP
- NTP

Basic

- Protocol
- Server SIP
- SIP Registration
- FXS Extension
- GSM Extension
- DTMF/CODEC
- VoIP Dial Plan
- GSM Dial Plan
- Static Route
- Hot Line

Advanced

- Gain & CID
- GSM PINs
- Fax**
- Service
- Filtering
- Security
- SNMP
- WEB Callback
- GSM Callback

Miscellaneous

- Call Status
- System Status
- Alarm Status
- GSM Status
- Call Log
- System Log
- Ping
- BTS Selection
- GSM BTS Info

Fax

Fax Mode T.38 Inband T.38 Bypass

Fax Rate Disable 2400 4800 7200 9600 12000 14400

Apply

FAX
Configure fax mode & rate (VoIP Lines)

Information

AddPac Technology
Model : GS1002_G2
H/W Version : 2.0
S/W Version : 8.00d
Smart Web Version : 0.4
Smart Web Build : Mar 24 2010
Voice Interface
G(2)S(2)
Protocol : SIP
Status : Unregistered
CurrentCalls: 0 Call
Network : Static 172.16.9.16
Mac Address: 0002.a400.0000
Unread Message:
P0:0(0)
P0:1(0)

Description

Enable or disable T.38/Inband T.38, which is fax internet protocol and specify Baudrate

Advanced - Service

Smart Web Manager
www.addpac.com

System

- Network Setup
- Language
- NAT
- PPTP
- NTP

Basic

- Protocol
- Server SIP
- SIP Registration
- FXS Extension
- GSM Extension
- DTMF/CODEC
- VoIP Dial Plan
- GSM Dial Plan
- Static Route
- Hot Line

Advanced

- Gain & CID
- GSM PINs
- Fax
- **Service**
- Filtering
- Security
- SNMP
- WEB Callback
- GSM Callback

Miscellaneous

- Call Status
- System Status
- Alarm Status
- GSM Status
- Call Log
- System Log
- Ping
- BTS Selection
- GSM BTS Info

Service

Applicaton Services

- Enable Telnet Server Port: 23 (default 23, 1-65535)
- Enable HTTP Server Port: 80 (default 80, 1-65535)
- Enable FTP Control Port: 21 (default 21, 1-65535)
Data Port: 20 (default 20, 1-65535)
- Enable Syslog Primary Server: [] Port: [] (default 514)
Secondary Server: [] Port: [] (default 514)
Log Level: 0-emergency
Log Command: disable

Timer

- Inter Digit Time: 3 sec (default 3, 1-600)

Call Service

- Transfer: Hook-Flash Not-assigned
- Hold: Hook-Flash Not-assigned

SIP Transfer

- Mode: blind Attended

Apply

Information

AddPac Technology
Model : GS1002_G2
H/W Version : 2.0
S/W Version : 8.00d
Smart Web Version : 0.4
Smart Web Build : Mar 24 2010
Voice Interface
G(2)S(2)
Protocol : SIP
Status : Unregistered
CurrentCalls: 0 Call
Network : Static 172.16.9.16
Mac Address: 0002.a400.0000
Unread Message:
P0:0(0)
P0:1(0)

Description

Enable or disable Telnet, HTTP, FTP and specify the access port and Call Hold/Transfer and Timer .

Service

- Configure application service(Telnet, HTTP, ftp, syslog)
- Configure IDT(Inter Digit Time)
- Configure Call-Transfer-Mode & Hook-Flash-Usage-Type.
- Configure Call-Transfer-Mode.

Advanced - Filtering

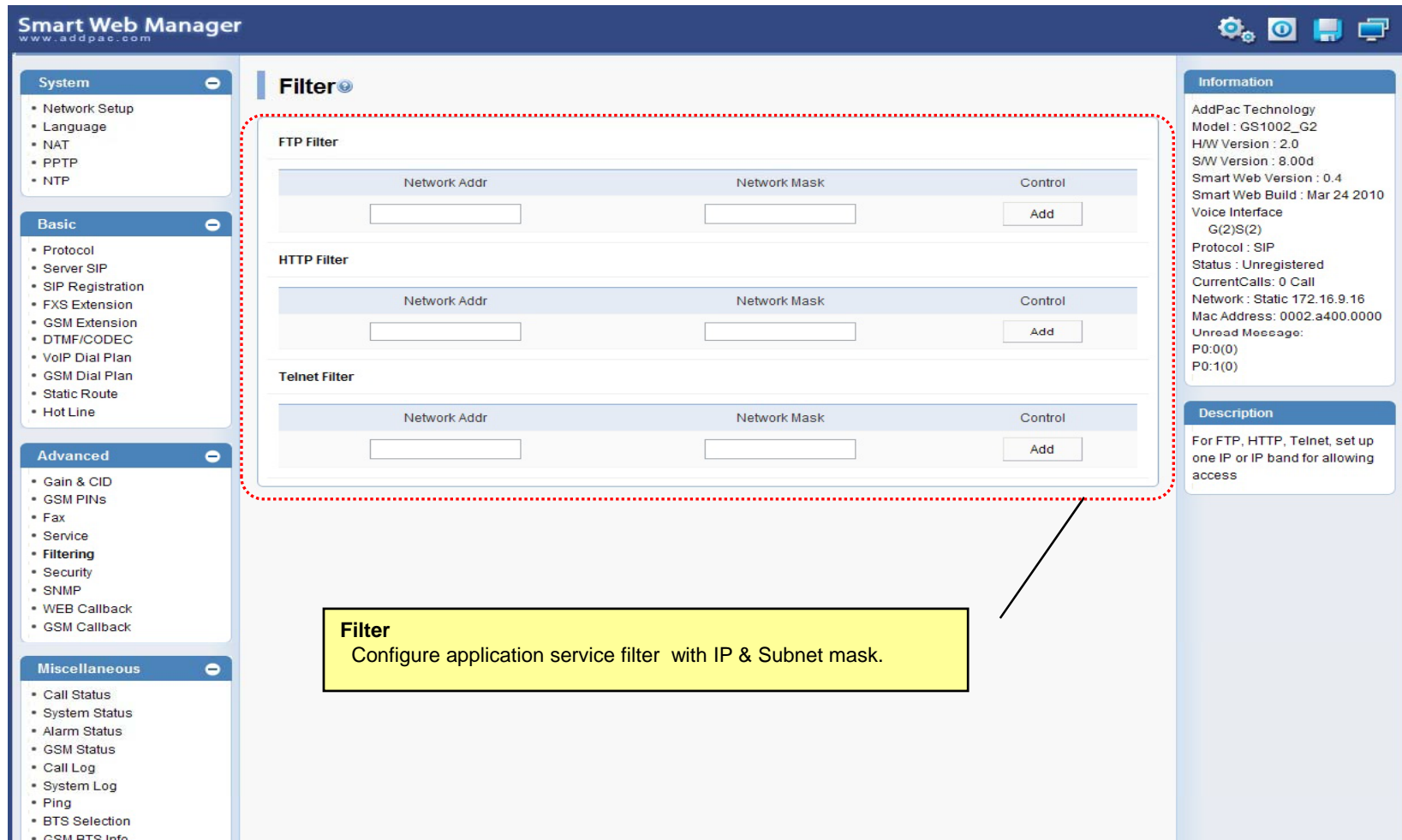

Smart Web Manager
www.addpac.com

System

- Network Setup
- Language
- NAT
- PPTP
- NTP

Basic

- Protocol
- Server SIP
- SIP Registration
- FXS Extension
- GSM Extension
- DTMF/CODEC
- VoIP Dial Plan
- GSM Dial Plan
- Static Route
- Hot Line

Advanced

- Gain & CID
- GSM PINs
- Fax
- Service
- **Filtering**
- Security
- SNMP
- WEB Callback
- GSM Callback

Miscellaneous

- Call Status
- System Status
- Alarm Status
- GSM Status
- Call Log
- System Log
- Ping
- BTS Selection
- GSM BTS Info

Filter

FTP Filter

Network Addr	Network Mask	Control
<input type="text"/>	<input type="text"/>	<input type="button" value="Add"/>

HTTP Filter

Network Addr	Network Mask	Control
<input type="text"/>	<input type="text"/>	<input type="button" value="Add"/>

Telnet Filter

Network Addr	Network Mask	Control
<input type="text"/>	<input type="text"/>	<input type="button" value="Add"/>

Information

AddPac Technology
Model : GS1002_G2
HW Version : 2.0
SW Version : 8.00d
Smart Web Version : 0.4
Smart Web Build : Mar 24 2010
Voice Interface
G(2)S(2)
Protocol : SIP
Status : Unregistered
CurrentCalls: 0 Call
Network : Static 172.16.9.16
Mac Address: 0002.a400.0000
Unread Message:
P0:0(0)
P0:1(0)

Description

For FTP, HTTP, Telnet, set up one IP or IP band for allowing access

Filter
Configure application service filter with IP & Subnet mask.

Advanced - Security

Smart Web Manager
www.addpac.com

System

- Network Setup
- Language
- NAT
- PPTP
- NTP

Basic

- Protocol
- Server SIP
- SIP Registration
- FXS Extension
- GSM Extension
- DTMF/CODEC
- VoIP Dial Plan
- GSM Dial Plan
- Static Route
- Hot Line

Advanced

- Gain & CID
- GSM PINs
- Fax
- Service
- Filtering
- **Security**
- SNMP
- WEB Callback
- GSM Callback

Miscellaneous

- Call Status
- System Status
- Alarm Status
- GSM Status
- Call Log
- System Log
- Ping
- BTS Selection
- GSM BTS Info

Security

IP Filtering Enable Disable

WarDialing Filtering Enable Disable

Allow Digit Length(IP to PSTN) Min Max

SIP Shutdown Enable Disable

Apply

Information

AddPac Technology
Model : GS1002_G2
HW Version : 2.0
SW Version : 8.00d
Smart Web Version : 0.4
Smart Web Build : Mar 24 2010
Voice Interface
G(2)S(2)
Protocol : SIP
Status : Unregistered
CurrentCalls: 0 Call
Network : Static 172.16.9.16
Mac Address: 0002.a400.0000
Unread Message:
P0:0(0)
P0:1(0)

Description

Configure the settings for IP authentication and protocol and incoming number

Security

- IP Filtering : Allowing only the inbound call which is registered to Call-Routing of the server by static IP.
- WarDialing : Allowing only the inbound call with the number registered to Inter-Office and phone-number.
- Digit Length : Allowing only the inbound call with the number registered to Inter-Office and phone-number
- SIP : SIP signaling packets are filtered.

Advanced – GSM Callback

GSM Callback
 The employee working at the out of office can use this function.

- The Call received from GSM network is automatically disconnected.
- GSM gateway calls to the calling number.

Calling Number White List
 The employee working at the out of office are usually registered.

GSM Callback

Calling Number Whitelist

Group	Index	DialPattern	Control
3	0	123T	<input type="checkbox"/>

Callback

GSM Port	My Number	WhiteList Group
P0:0		3
P0:1		N.A.

Callback
 The white list group is adapted to specific GSM port

Information

AddPac Technology
 Model : GS1002_G2
 HW Version : 2.0
 SW Version : 8.00d
 Smart Web Version : 0.4
 Smart Web Build : Mar 24 2010

Voice Interface
 G(2)S(2)
 Protocol : SIP
 Status : Unregistered
 CurrentCalls : 0 Call
 Network : Static 172.16.9.16
 Mac Address : 0002.a400.0000
 Unread Message:
 P0:0(0)
 P0:1(0)

Description

Execute GSM callback function and Configure callback whitelist

Miscellaneous – Call Status

Smart Web Manager
www.addpac.com

System

- Network Setup
- Language
- NAT
- DTMF/CODEC
- VoIP Dial Plan
- GSM Dial Plan
- Static Route
- Hot Line

Miscellaneous

- Call Status
- System Status
- Alarm Status
- GSM Status
- Call Log
- System Log
- Ping
- BTS Selection
- GSM BTS Info

Call Status

Port Status (Analog)

Slot	Port	Port Group			
		0()	1()	2()	3()
SLOT 0	Status	I	I	I	I
	Select	<input type="checkbox"/>	<input type="checkbox"/>	<input type="checkbox"/>	<input type="checkbox"/>

Unblock Block

Connection State : (Connected) (Disconnected || Blocked)
Call State : (Idle) (Ring || Dial) (Called) (Calling) (Blocked)

Call Status

Port	Direction	Established Time	Calling Number	Called Number	CODEC	Src/Dest. IP

Information

AddPac Technology
Model : GS1002_G2
H/W Version : 2.0
S/W Version : 8.00d
Smart Web Version : 0.4
Smart Web Build : Mar 24 2010
Voice Interface
G(2)S(2)
Protocol : SIP
Status : Unregistered
CurrentCalls : 0 Call
Network : Static 172.16.9.16
Mac Address : 0002.a400.0000
Unread Message:
P0:0(0)
P0:1(0)

Description

Verify port status and retrieve the present call information

Analog Port
Real-time display about analog port status (occupation, call status). Provide a specific port blocking function

Active Call Status
Real-time display about current active call status (calling party addr, called party addr. Codec, etc)

Miscellaneous – System Status

Smart Web Manager
www.addpac.com

System

- Network Setup
- Language
- NAT
- PPTP
- NTP

Advanced

- VoIP Dial Plan
- GSM Dial Plan
- Static Route
- Hot Line

Miscellaneous

- Call Status
- **System Status**
- Alarm Status
- GSM Status
- Call Log
- System Log
- Ping
- BTS Selection
- GSM BTS Info

Information

AddPac Technology
Model : GS1002_G2
H/W Version : 2.0
S/W Version : 8.00d
Smart Web Version : 0.4
Smart Web Build : Mar 24 2010

Voice Interface
G(2)S(2)
Protocol : SIP
Status : Unregistered
CurrentCalls: 0 Call
Network: Static 172.16.9.16
Mac Address: 0002.a400.0000
Unread Message:
P0:0(0)
P0:1(0)

Description

Verify the present port information, Server Register status, CPU and Memory usage

System Status

Voice Port

Port	LineType	Status	InGain	OutGain	TieType	TieDigits	CallNum	Tcalled	Tcalling
0/ 0	GSM	Idle	0	0	none		-1	-1	-1
0/ 1	GSM	Idle	0	0	none		-1	-1	-1
0/ 2	FXS	Idle	0	0	hot-line	8888	-1	-1	-1
0/ 3	FXS	Idle	0	0	none		-1	-1	-1

SIP-UA

Proxyserver Registration Information
proxyserver registration option = e164
Proxyserver list :

Server address	Port	Priority	Domain	Status (LastFailReason)
172.17.116.215	5060	128	any	Failed(Rx:OtherMsg)

Proxy Server registration status :

E.164	UserName	Password	Port	Status
1005	1005	NONE	0/ 2	Registered
33	33	NONE	0/ 0	Failed

SIP UA Timer counters
retry counter = 10

SIP UA Timer values
 tretry (sip retry timer) = 500 msec.
 tinterval (sip retry max interval timer) = 4 sec.
 treg (sip register timer) = 60 sec.
 tregtry (sip register retry timer) = 20 sec.
 texpires (sip invite expire timer) = 180 sec.
 tsipping (sip ping timer) = 45 sec.

SIP UA Session Timer value
 Min-SE = 1800 sec.
 Session-Expires = 1800 sec.

SIP DNS SRV Query : Disable
 SIP Call Transfer Mode : Basic
 SIP Media Channel Start Mode : Default
 SIP Reliable Provisional Response Option : Supported with value <100rel>
 SIP Response Option : default
 SIP Local Domain : NULL
 SIP Special Char : NULL
 SIP Routing Method of Incoming Call : Default
 SIP Remote-Party-ID : Disabled

System Status

- voice port status & information
- SIP-UA status & information
- gateway status & information
- system utilization information

Miscellaneous – Alarm Status

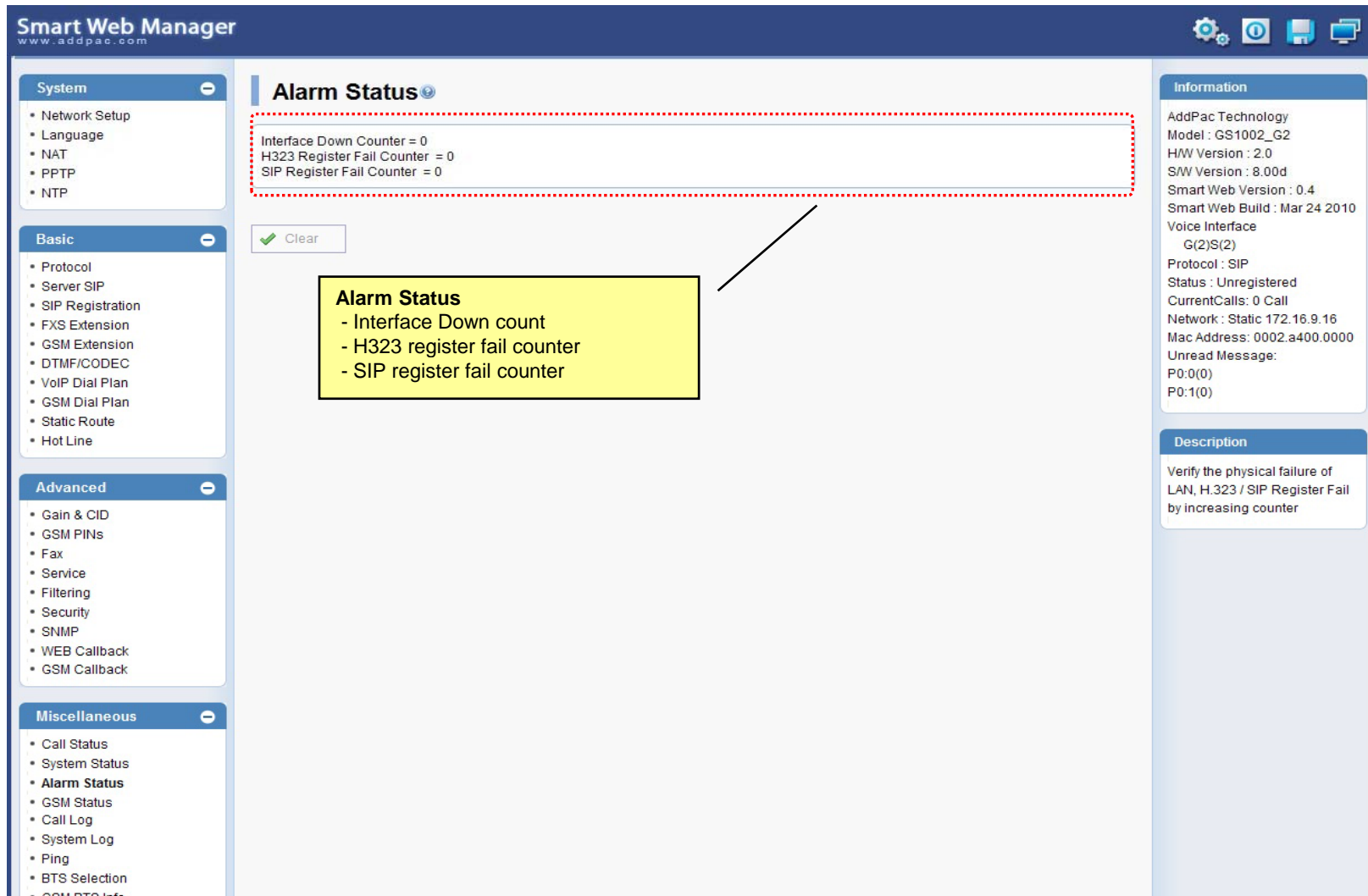

The screenshot shows the 'Smart Web Manager' interface with the 'Alarm Status' page selected. The left sidebar contains a navigation menu with categories: System, Basic, Advanced, and Miscellaneous. The 'Alarm Status' page displays a red dashed box around the following text:

Interface Down Counter = 0
H323 Register Fail Counter = 0
SIP Register Fail Counter = 0

Below this text is a 'Clear' button with a green checkmark icon. A yellow callout box points to the red dashed box and contains the following text:

Alarm Status
- Interface Down count
- H323 register fail counter
- SIP register fail counter

The right sidebar contains an 'Information' section with the following details:

AddPac Technology
Model : GS1002_G2
HW Version : 2.0
SW Version : 8.00d
Smart Web Version : 0.4
Smart Web Build : Mar 24 2010
Voice Interface
G(2)S(2)
Protocol : SIP
Status : Unregistered
CurrentCalls: 0 Call
Network : Static 172.16.9.16
Mac Address: 0002.a400.0000
Unread Message:
P0:0(0)
P0:1(0)

Below the information is a 'Description' section with the following text:

Verify the physical failure of LAN, H.323 / SIP Register Fail by increasing counter

Miscellaneous – GSM Status

Smart Web Manager
www.addpac.com

GSM Status

GSM Port Status & Information

Port	My Phone Number	Device Information		Accounting (Used/Quota/Free)	
		Register Status	Signal Strength	Voice Quota(secs)	SMS Quota(E.A.)
P0:0		REG	0dB	0 / 36000 / 36000	0 / 300 / 300
P0:1		REG	0dB	0 / -1 / -1	0 / -1 / -1

GSM Status

- my number
- GSM register status
- GSM signal strength
- Account information
 - * voice quota (used / quota / free)
 - * SMS quota (used / quota / free)

Information

AddPac Technology
Model : GS1002_G2
H/W Version : 2.0
S/W Version : 8.00d
Smart Web Version : 0.4
Smart Web Build : Mar 24 2010
Voice Interface
G(2)S(2)
Protocol : SIP
Status : Unregistered
CurrentCalls: 0 Call
Network : Static 172.16.9.16
Mac Address: 0002.a400.0000
Unread Message:
P0:0(0)
P0:1(0)

Description

Diaplay GSM wireless status

Miscellaneous – Call Log

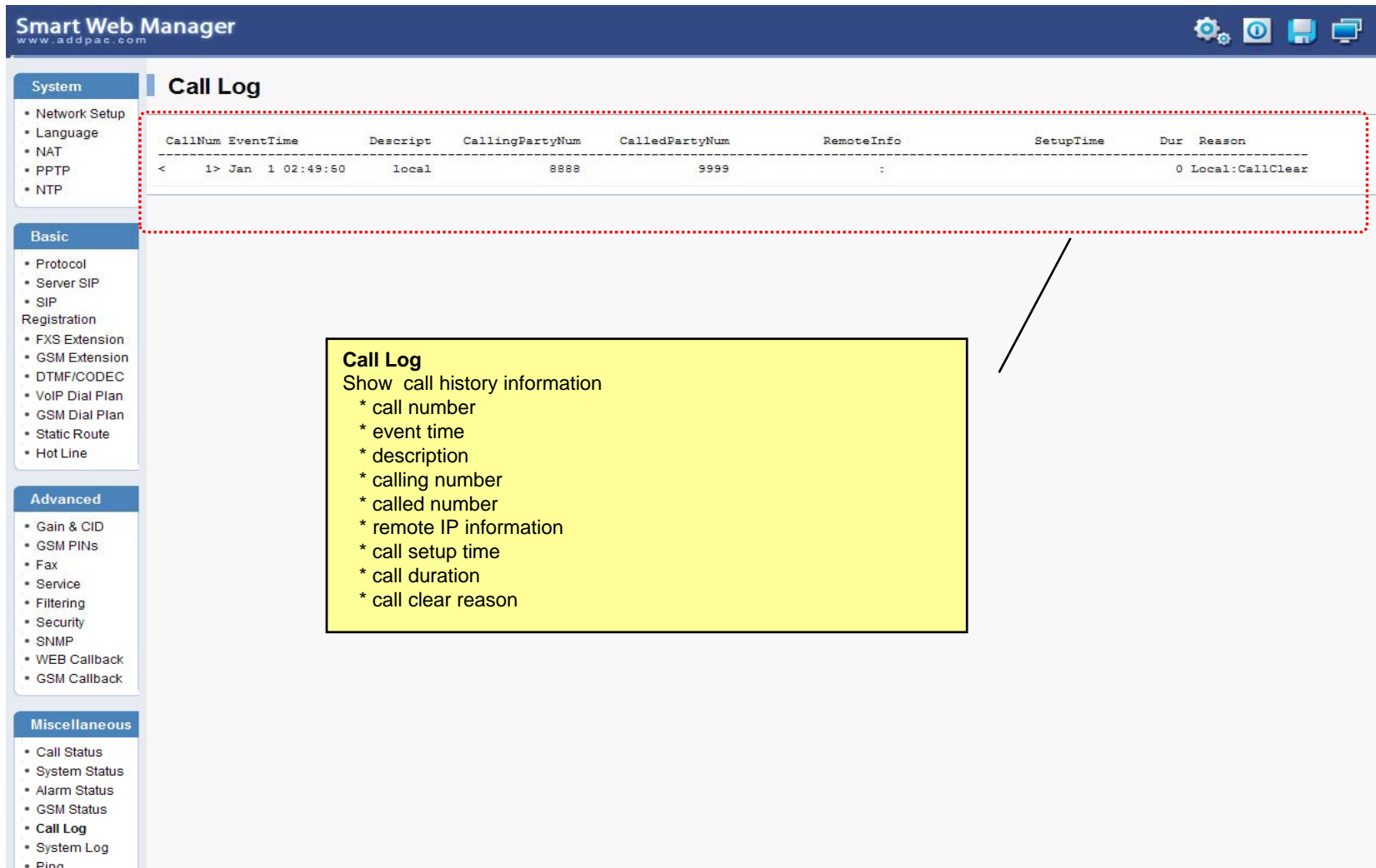

The screenshot shows the 'Smart Web Manager' interface with the 'Call Log' section active. The interface includes a left sidebar with navigation menus for System, Basic, Advanced, and Miscellaneous. The main content area displays a table of call log entries. A red dashed box highlights the table header and the first data row. A yellow callout box provides a list of fields shown in the table.

CallNum	EventTime	Descript	CallingPartyNum	CalledPartyNum	RemoteInfo	SetupTime	Dur	Reason
< 1>	Jan 1 02:49:50	local	8888	9999	:		0	Local:CallClear

Call Log
Show call history information

- * call number
- * event time
- * description
- * calling number
- * called number
- * remote IP information
- * call setup time
- * call duration
- * call clear reason

Miscellaneous – System Log

Smart Web Manager
www.addpac.com

System Log

command logging buffers (messages logged)

event logging buffers (messages logged)

System Log
- command log
- system alarm log (ex : interface down)

Information
AddPac Technology
Model : GS1002_G2
HW Version : 2.0
SW Version : 8.00d
Smart Web Version : 0.4
Smart Web Build : Mar 24 2010
Voice Interface
G(2)S(2)
Protocol : SIP
Status : Unregistered
CurrentCalls: 0 Call
Network : Static 172.16.9.16
Mac Address: 0002.a400.0000
Unread Message:
P0:0(0)
P0:1(0)

Description
Retrieve the system log

System
• Network Setup
• Language
• NAT
• PPTP
• NTP

Basic
• Protocol
• Server SIP
• SIP Registration
• FXS Extension
• GSM Extension
• DTMF/CODEC
• VoIP Dial Plan
• GSM Dial Plan
• Static Route
• Hot Line

Advanced
• Gain & CID
• GSM PINs
• Fax
• Service
• Filtering
• Security
• SNMP
• WEB Callback
• GSM Callback

Miscellaneous
• Call Status
• System Status
• Alarm Status
• GSM Status
• Call Log
• **System Log**
• Ping
• BTS Selection
• GSM BTS Info

Miscellaneous - Ping

Smart Web Manager
www.addpac.com

System

- Network Setup
- Language
- NAT

Advanced

- Protocol
- Server SIP
- SIP Registration
- FXS Extension
- GSM Extension
- DTMF/CODEC
- VoIP Dial Plan
- GSM Dial Plan
- Static Route
- Hot Line

Miscellaneous

- Call Status
- System Status
- Alarm Status
- GSM Status
- Call Log
- System Log
- **Ping**
- BTS Selection
- GSM BTS Info

Ping

Host address Start

Information

AddPac Technology
Model : GS1002_G2
H/W Version : 2.0
S/W Version : 8.00d
Smart Web Version : 0.4
Smart Web Build : Mar 24 2010
Voice Interface
G(2)S(2)
Protocol : SIP
Status : Unregistered
CurrentCalls: 0 Call
Network : Static 172.16.9.16
Mac Address: 0002.a400.0000
Unread Message:
P0:0(0)
P0:1(0)

Description

Verify the physical failure of LAN, H.323 / SIP Register Fail by increasing counter

PING
You can diagnose network status by PING.

PING
Show real time ping status.

Miscellaneous – BTS Selection

Smart Web Manager
www.addpac.com

GSM / BTS Control

Port	BTS Selection Mode	BCCH	RSSI & Timer
P0:0	Auto	72EA	-25B -1(sec)
P0:1	Auto	72EA	-25B -1(sec)

P0:0 Auto BCCH RSSI -10 dB Timer 0 sec

Apply

BTS control
Configure BTS selection option
* Auto mode
* forced BCCH
* forced RSSI level

Information
AddPac Technology
Model : GS1002_G2
HW Version : 2.0
SW Version : 8.00d
Smart Web Version : 0.4
Smart Web Build : Mar 24 2010
Voice Interface
G(2)S(2)
Protocol : SIP
Status : Unregistered
CurrentCalls: 0 Call
Network : Static 172.16.9.16
Mac Address : 0002.a400.0000
Unread Message:
P0:0(0)
P0:1(0)

Description
Configure BTS selection mode

Miscellaneous – GSM BTS Info

Smart Web Manager
www.addpac.com

GSM BCCH Cell Information

PORT 0:0 PORT 0:1

Information

AddPac Technology
Model : GS1002_G2
HW Version : 2.0
SW Version : 8.00d
Smart Web Version : 0.4
Smart Web Build : Mar 24 2010
Voice Interface
G(2)S(2)
Protocol : SIP
Status : Unregistered
CurrentCalls : 0 Call
Network : Static 172.16.9.16
Mac Address: 0002.a400.0000
Unread Message:
P0:0(0)
P0:1(0)

Description

Verify GSM wireless signal status

BCCH Cell Information
Shows serving cell information (center circle) and neighboring cell information.
* LAC : Location Area Code
* CI : Cell ID
* BSIC : Basic Station ID Code
* BCCH : Broadcast Control Channel
* RSSI : Receiver Signal Strength

System

- Network Setup
- Language
- NAT
- PPTP
- NTP

Basic

- Protocol
- Server SIP
- SIP Registration
- FXS Extension
- GSM Extension
- DTMF/CODEC
- VoIP Dial Plan
- GSM Dial Plan
- Static Route
- Hot Line

Advanced

- Gain & CID
- GSM PINs
- Fax
- Service
- Filtering
- Security
- SNMP
- WEB Callback
- GSM Callback

Miscellaneous

- Call Status
- System Status
- Alarm Status
- GSM Status
- Call Log
- System Log
- Ping
- BTS Selection
- GSM BTS Info

LCR – Black & White List

Smart Web Manager
www.addpac.com

GSM LCR / Black List & White List

BlackList

Index	DialPattern	Control
0	888T	<input type="checkbox"/>
		Delete
0		Add

WhiteList

Index	DialPattern	Control
0	2...	<input type="checkbox"/>
		Delete
0		Apply

Information

AddPac Technology
Model : GS1002_G2
HW Version : 2.0
SW Version : 8.00d
Smart Web Version : 0.4
Smart Web Build : Mar 24 2010
Voice Interface
G(2)S(2)
Protocol : SIP
Status : Unregistered
CurrentCalls : 0 Call
Network : Static 172.16.9.16
Mac Address : 0002.a400.0000
Unread Message:
P0:0(0)
P0:1(0)

Description

Configure black & white list

LCR Black & White List
Black List : The patterns are disallowed GSM outbound call.
White List : The patterns are allowed GSM outbound call.

LCR – Time Interval

The screenshot displays the Smart Web Manager interface for configuring GSM LCR / Time Interval Groups. The main content area is titled "GSM LCR / Time Interval Group" and contains a "TimeInterval" section. This section features a table with the following data:

Group	Days	StartTime(hh:mm)	EndTime(hh:mm)	Control
0	Weekdays	00:00	23:59	<input type="checkbox"/>

Below the table, there are input fields for adding a new group: "0" for the group ID, "weekend" for the days, and "0 0" for both the start and end times. There are also "Delete" and "Add" buttons.

A yellow callout box points to the table with the text: "Time Interval GSM outbound call is restricted by Time Interval".

The left sidebar contains a navigation menu with categories: System, Basic, Advanced, and Miscellaneous. The right sidebar contains "Information" and "Description" sections. The "Information" section lists system details such as AddPac Technology, Model: GS1002_G2, and Smart Web Build: Mar 24 2010. The "Description" section contains the text: "Configure time interval group".

LCR – Tariff Group

Smart Web Manager
www.addpac.com

GSM LCR / Tariff Group

Tariff Group

Group	Time Group	Restore Call Limit		Accounting Period		Free Quota		Control
Type	RestoreDay	First(sec)	Others(sec)	Voice(min)	SMS(E.A.)			
0	0	monthly	15	30	10	600	300	<input type="checkbox"/>
0	0	daily	1					Delete Add

TariffPort

Port	TariffGroup
P0:0	0
P0:1	N.A.
P0:2	N.A.
P0:3	N.A.

Information

AddPac Technology
Model : GS1002_G2
H/W Version : 2.0
S/W Version : 8.00d
Smart Web Version : 0.4
Smart Web Build : Mar 24 2010
Voice Interface
G(2)S(2)
Protocol : SIP
Status : Unregistered
CurrentCalls : 0 Call
Network : Static 172.16.9.16
Mac Address : 0002.a400.0000
Unread Message:
P0:0(0)
P0:1(0)

Description

Configure tariff group

Time Interval Group
Time interval Group is adapted to this tariff group.

Restore call limit
Quota restore time

Accounting Period
Used to voice call.
(ex)
- configured as First (30 seconds) Others(10 seconds)

first connect -- 30 seconds are accounted.
after 30 seconds -- 10 seconds are additionally accounted.
after 10 seconds – 10 seconds are additionally accounted.
and so on.

Tariff Group
Tariff group is adapted to specific GSM port.

Free quota
Free quota information.
Current Usage information is supported at GSM Status.

LCR – LCR Test

Smart Web Manager
www.addpac.com

System

- Network Setup
- Language
- NAT
- PPTP
- NTP

LCR Test

Caller:

Called Number:

```
< 1> LCR : =====
< 2> LCR : == GSM LCR(Least Cost Route) Simulator Start ==
< 3> LCR : =====
< 4> LCR : -- src digits : 8888(GSM) -> dst digits : 9999(GSM)
< 5> LCR : -- MatchAllProcess After Sorted
< 6> LCR : <0> id(3048) dest(T) prefer(0) selected(0)
< 7> LCR : -- Trying : <0> id(3048) dest(T)
< 8> LCR : -- Error: Outbound White Group(id:1) UnMatched
< 9> LCR : -----
< 10> LCR : -- Result : Fail
< 11> LCR : =====
< 12> LCR : == GSM LCR(Least Cost Route) Simulator End ==
< 13> LCR : =====
```

Information

AddPac Technology
Model : GS1002_G2
H/W Version : 2.0
S/W Version : 8.00d
Smart Web Version : 0.4
Smart Web Build : Mar 24 2010
Voice Interface
G(2)S(2)
Protocol : SIP
Status : Unregistered
CurrentCalls : 0 Call
Network : Static 172.16.9.16
Mac Address : 0002.a400.0000
Unread Message:
P0:0(0)
P0:1(0)

Description

LCR Test

LCR Test
LCR simulator

LCR Test
Show real time simulation status.

Advanced

- Gain & CID
- GSM PIN

SMS – Inbox

Smart Web Manager
www.addpac.com

GSM SMS / InBox

number of messages are 0 P0:0 OK

Index	Sender	Received	Message	Select
				Delete

GSM SMS / In Box

- total message
- unread messages (Blue color)
- received time
- content

Information

AddPac Technology
Model : GS1002_G2
HW Version : 2.0
SW Version : 8.00d
Smart Web Version : 0.4
Smart Web Build : Mar 24 2010
Voice Interface
G(2)S(2)
Protocol : SIP
Status : Unregistered
CurrentCalls : 0 Call
Network : Static 172.16.9.16
Mac Address : 0002.a400.0000
Unread Message:
P0:0(0)
P0:1(0)

Description

SMS – SMS New Message

The screenshot shows the 'Smart Web Manager' interface for sending an SMS message. The main content area is titled 'GSM SMS / New Message'. It features a form with the following fields:

- Phone Number:
- Message:
- Port:

Below the form is a 'Send' button. A red dashed box highlights the form fields. A yellow callout box with a black border contains the text: 'New Message send a new message to the other GSM mobile phone.' An arrow points from this callout box to the form area. Above the form, it says 'Max size is 80 characters'.

The left sidebar contains a navigation menu with the following categories:

- System
 - Network Setup
 - Language
 - NAT
 - PPTP
 - NTP
- Basic
 - Protocol
 - Server SIP
 - SIP Registration
 - FXS Extension
 - GSM Extension
 - DTMF/CODEC
 - VoIP Dial Plan
 - GSM Dial Plan
 - Static Route
 - Hot Line
- Advanced
 - Gain & CID
 - GSM PINs
 - Fax
 - Service
 - Filtering
 - Security
 - SNMP
 - WEB Callback
 - GSM Callback
- Miscellaneous
 - Call Status
 - System Status
 - Alarm Status
 - GSM Status
 - Call Log
 - System Log
 - Ping
 - BTS Selection
 - GSM BTS Info

The right sidebar contains an 'Information' section with the following details:

- AddPac Technology
- Model: GS1002_G2
- HW Version: 2.0
- SW Version: 8.00d
- Smart Web Version: 0.4
- Smart Web Build: Mar 24 2010
- Voice Interface
 - G(2)S(2)
- Protocol: SIP
- Status: Unregistered
- CurrentCalls: 0 Call
- Network: Static 172.16.9.16
- Mac Address: 0002.a400.0000
- Unread Message:
 - P0:0(0)
 - P0:1(0)

Below the information is a 'Description' section with a text area.



Thank you!

AddPac Technology Co., Ltd.
Sales and Marketing

Phone +82.2.568.3848 (KOREA)

FAX +82.2.568.3847 (KOREA)

E-mail sales@addpac.com