



# AP-GS708S

## 8-Port GSM VoIP Gateway

High Performance GSM VoIP Gateway Solution



# **AddPac**

**AddPac Technology**

Sales and Marketing

[www.addpac.com](http://www.addpac.com)

# Contents

- Product Overview
- Hardware Specification
- GSM Module Specification
- APOS Technology
- VoIP (Voice over IP) service
- Advanced QoS Features
- Network Protocols
- Network Management
- Smart Web Management
- Security Management
- Application Service
- Ordering Information



# Product Overview

## AP-GS708S 8-Port GSM VoIP Gateway

- 8-Port GSM VoIP Gateway Solution
- 8-Port SIM Slots, 8-Port Antenna Interface
- GSM VoIP Interface(LAN) Support
- H.323/SIP Dual Concurrent Stack Embedded
- High Performance RISC & Programmable DSP Architecture
- G.711/G.726/G.723/G.729, T.38 Fax , VAD, etc
- Powerful Network Protocols (PPPoE, DHCP, Static Routing, etc)
- Two(2) 10/100Mbps Fast Ethernet (IP Share ,etc)
- One(1) RS-232C Port for Command Line Interface
- Firmware Upgradeable Architecture
- Smart NMS for Large Scale Deployment
- Advanced Voice QoS Mechanism
- Light and Compact Design with External Power Supply

# Product Highlights

AP-GS708S 8-Port GSM VoIP Gateway

## Powerful GSM VoIP Gateway

State-of-art Signaling  
H.323, SIP  
Concurrent Dual Stack

Light and  
Compact Design

Advanced Smart Web  
Manager Support

High Performance RISC CPU  
+ Programmable DSP

Excellent Voice Quality  
G.729/G.723/G726/G711

Broadband IP Networking  
With Two(2) 10/100Mbps  
Fast Ethernet

APOS™ Technology  
Firmware Upgradeable Architecture

Smart NMS Support

Powerful Network Protocol  
Support

Powerful Trouble Shooting &  
Debugging Feature Support

Advanced Voice  
Traffic QoS Mechanism

**AddPac**

[www.addpac.com](http://www.addpac.com)

# APOS Technology

AP-GS708S 8-Port GSM VoIP Gateway

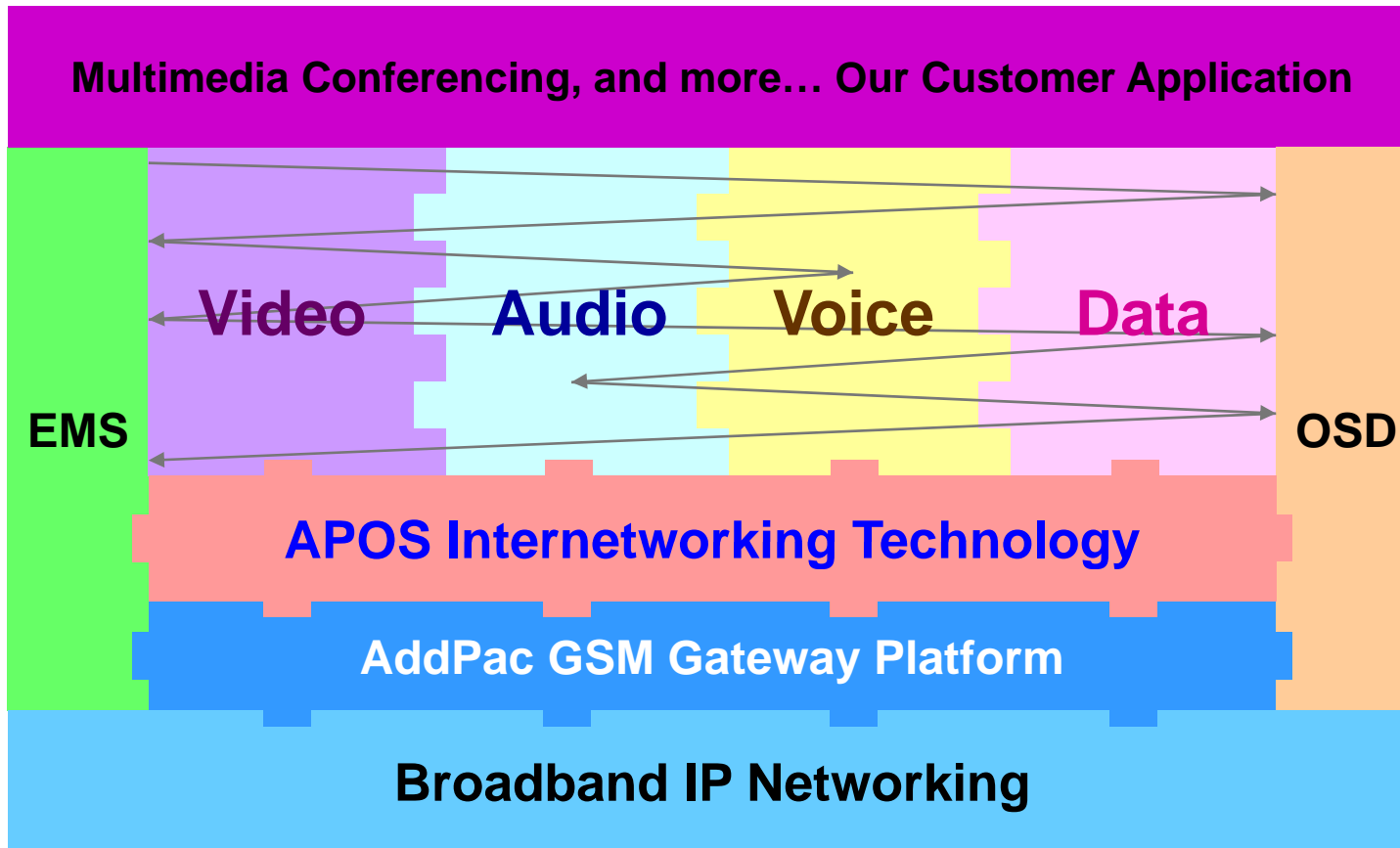

- APOS : AddPac Internetworking Operating System
- OSD : On- Screen Display
- EMS : Element Management System

# Hardware Specification

AP-GS708S 8-Port GSM VoIP Gateway

RISC  
CPU

High-end  
DSP

- RISC Microprocessor Computing Power
- Powerful High-End DSP for VoIP Interface
- 8-Port GSM VoIP Gateway
- 8-Port SIM Card Slots
- 8-Port GSM Antenna Interface
- Network Interface for VoIP Direct Interface
  - Two(2) 10/100Mbps Fast Ethernet (RJ45)
- RS232C Console Interface for CLI
- Run LED, LAN LED, Port LEDs at Front Side
- Compact and Light Design with External Power Supply

# Hardware Specification

AP-GS708S 8-Port GSM VoIP Gateway

RISC  
CPU

High-end  
DSP

AP-GS708S GSM VoIP Gateway	Basic Specifications
GSM Port	8-Port GSM VoIP Interface
GSM Antenna Interface	8-Port GSM Antenna Interface
SIM Card Slot Interface	8-Port GSM SIM Card Slot
Ethernet Interface	Two(2) 10/100Mbps Fast Ethernet (RJ-45)
Console Interface	One(1) RS-232C Interface for CLI (RJ45)
Flash Memory	4Mbyte High-speed Flash Memory
Base Memory	32Mbyte High-speed SDRAM
Power Requirement	Power Supply Adaptor / VAC 110~220V, 50/60Hz, 12V/3.4A
Operating Temperature	0°C ~ 45°C (32 °F ~ 122°F)
Storage Temperature	-40°C ~ 85°C (-40°C ~ 185°F)
Relative Humidity	5% ~ 95% (Non-condensing)
Dimension(H x W x D)	44mm x 265mm x 165mm
Weight	0.66Kg

# Hardware Specification

AP-GS708S 8-Port GSM VoIP Gateway

RISC  
CPU

High-end  
DSP

## Front Side View

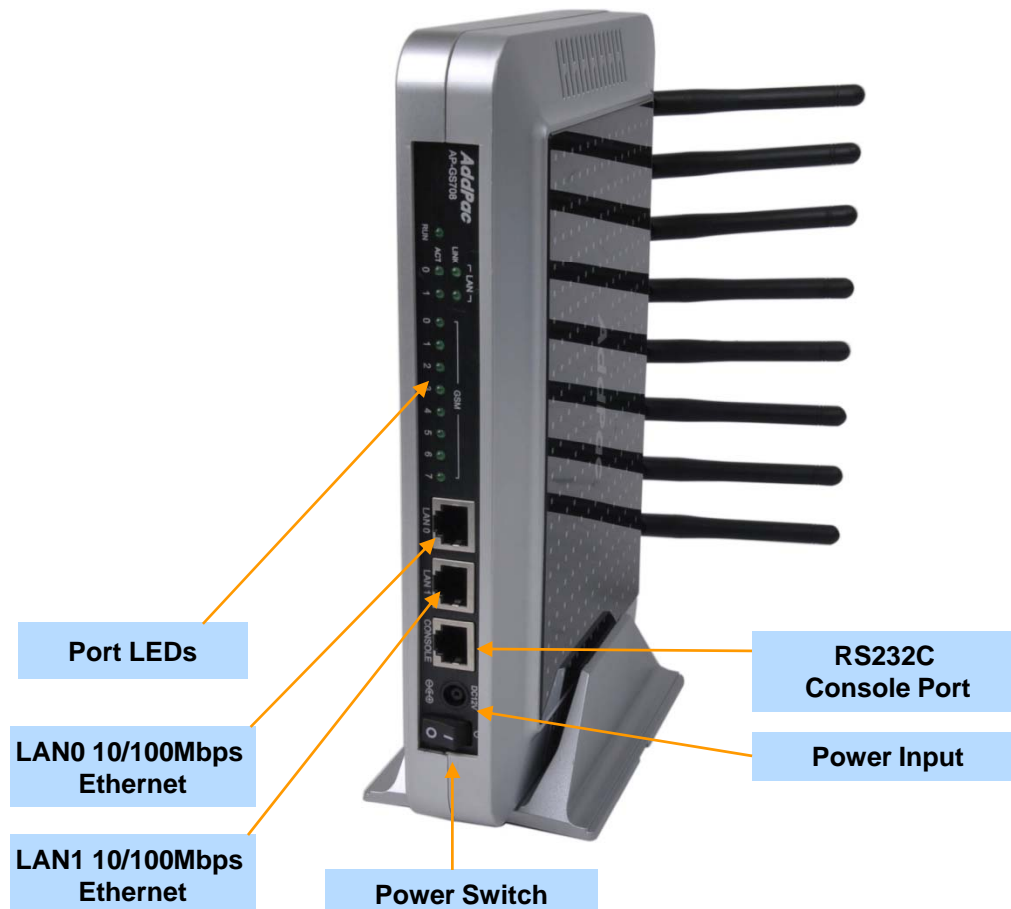

**AddPac**

[www.addpac.com](http://www.addpac.com)



# Hardware Specification

AP-GS708S 8-Port GSM VoIP Gateway

RISC  
CPU

High-end  
DSP

## Back Side View

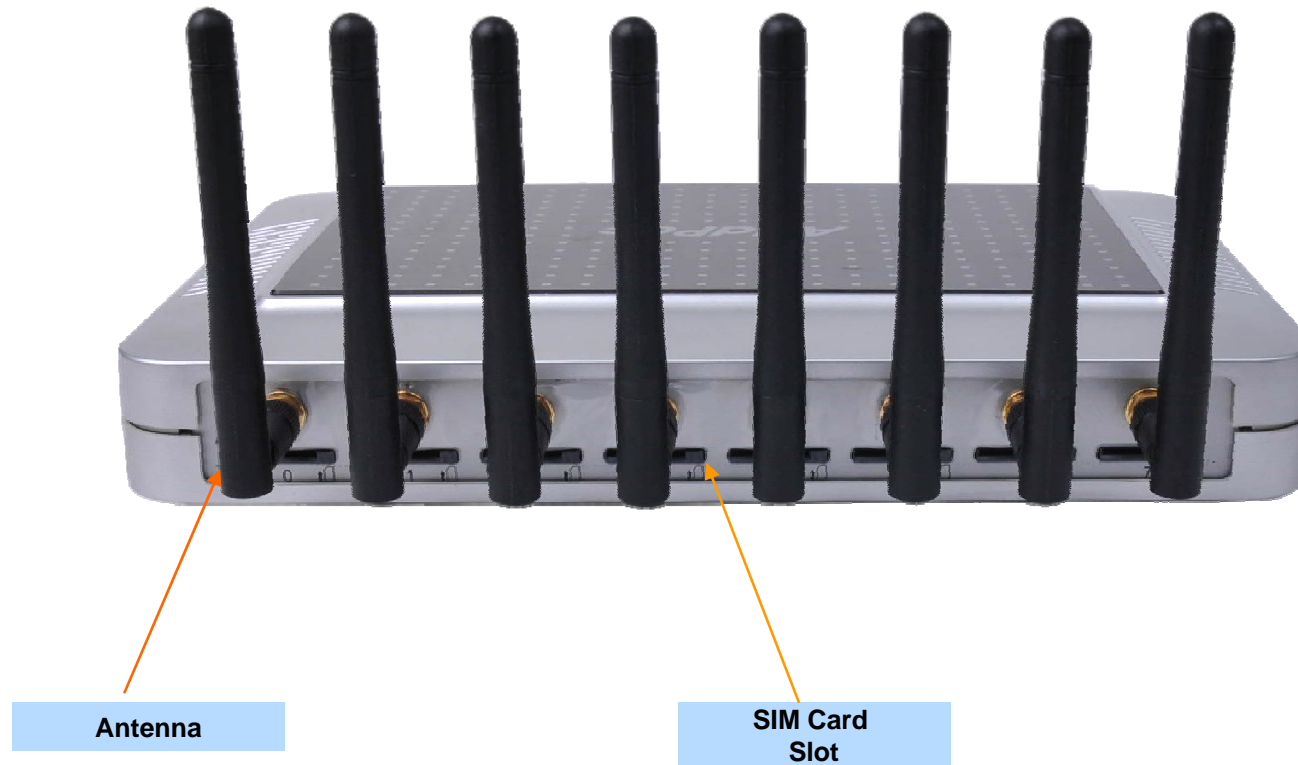

# Hardware Specification

AP-GS708S 8-Port GSM VoIP Gateway

RISC  
CPU

High-end  
DSP

## GSM VoIP Gateway Service Diagram

AP-GS708S Internal H/W Block Diagram

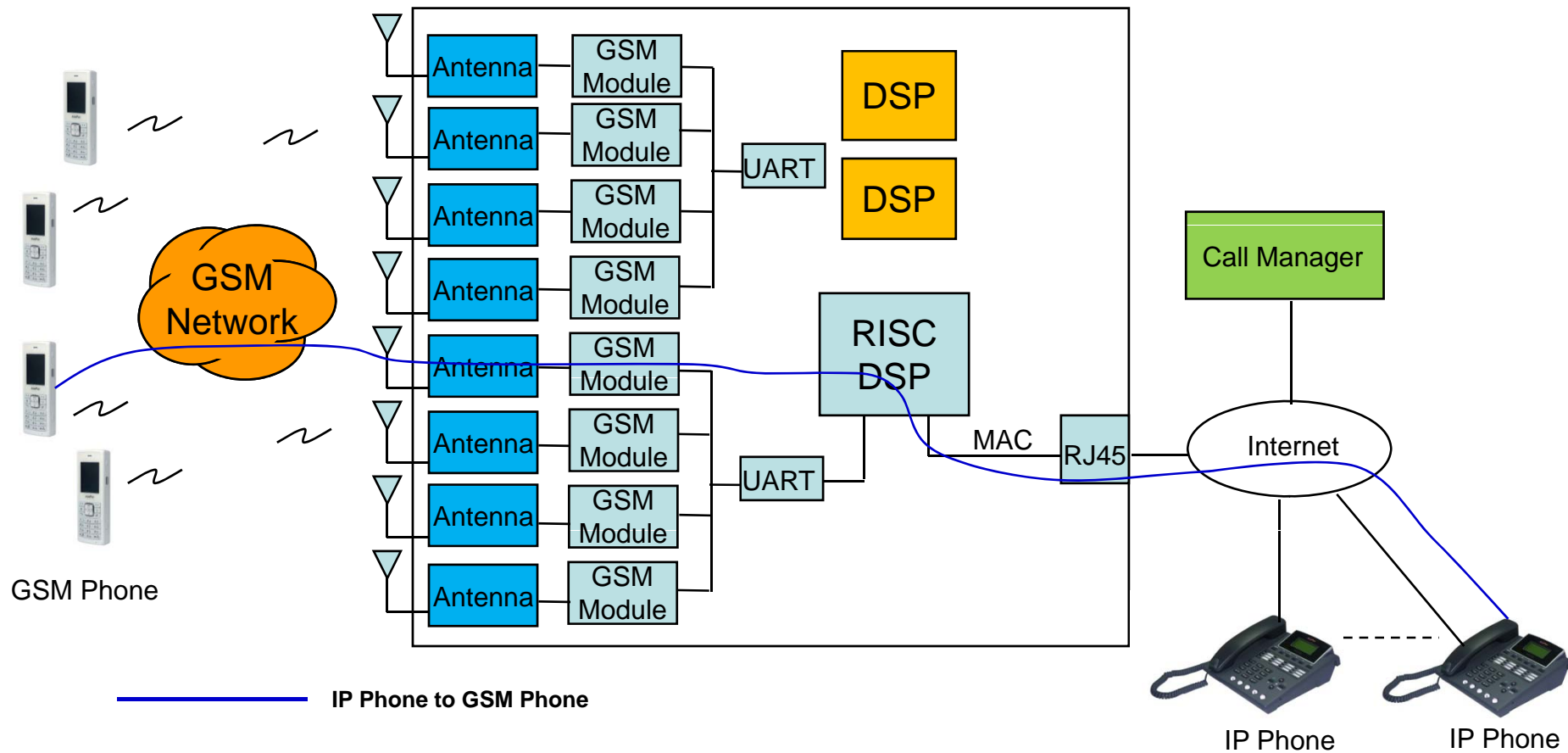

# VoIP (Voice over IP) Service

AP-GS708S 8-Port GSM VoIP Gateway

- H.323, SIP Dual Stack
- H.323
  - ITU-T Standard H.323 v3 Support
  - Support H.245 Tunneling
  - Including H.235 Security Features
- SIP
  - IETF RFC3261 or RFC2543 SIP Standard

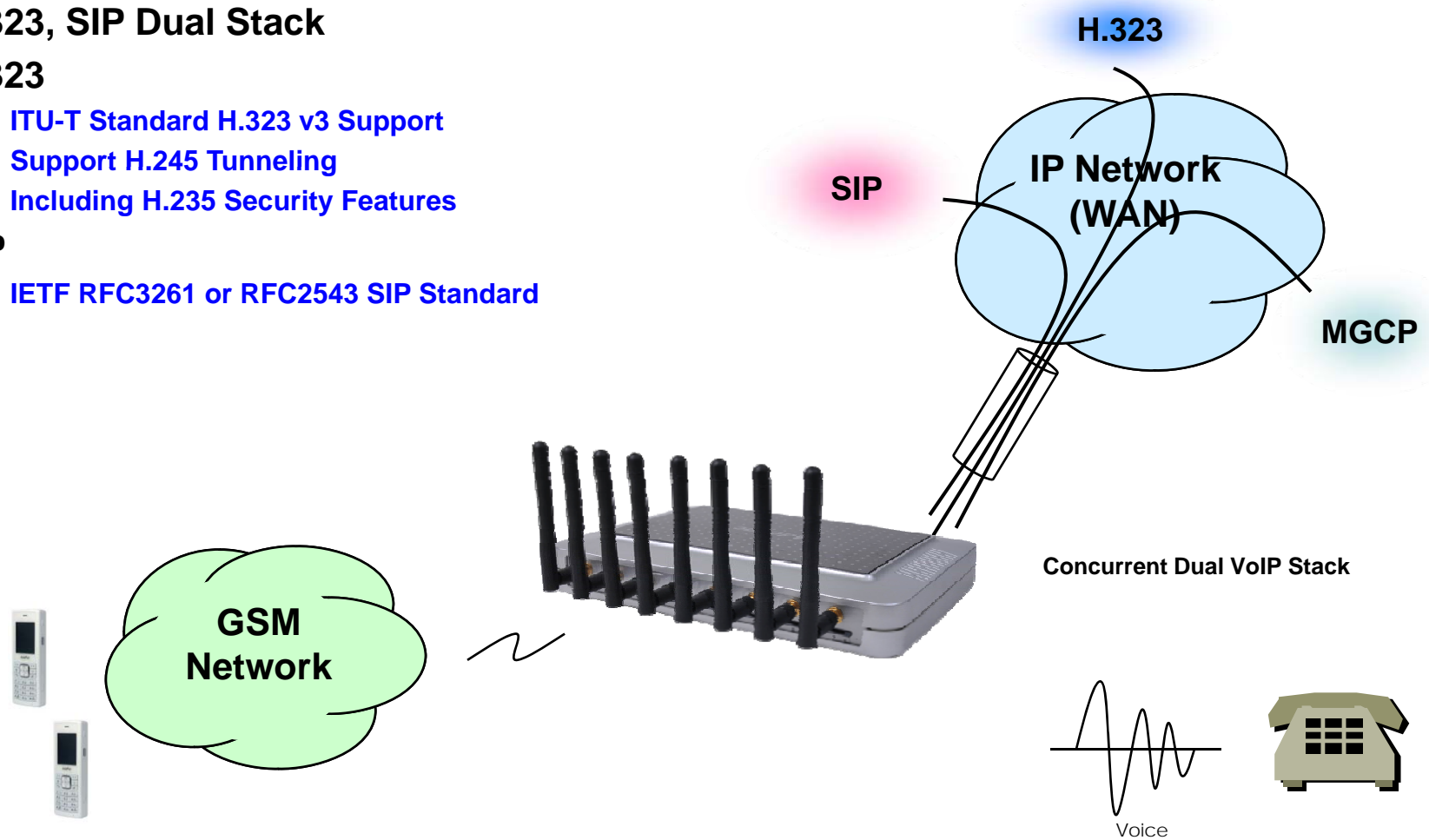

# VoIP (Voice over IP) Service

## AP-GS708S 8-Port GSM VoIP Gateway

- **H.323**

- Fast connect, normal connect support
- H.245 tunneling support
- Q.931 response message setting for inbound VoIP calls
- H.245 logical channel open timing selection function
- Start H.245 procedure support
- DTMF / Hook flash relay with H.245 alphanumeric / signal
- Secondary gatekeeper support
- Gatekeeper assignment according to the domain name
- Gatekeeper discovery with multicast
- Lightweight RRQ support
- Signaling TCP port assignment
- Resource threshold setting with RAI
- H.235 clear-token, crypto-token support
- canMapAlias support
- Technical prefix (supported prefix) support
- Public IP assignment in NAT environment

- **SIP**

- Gateway-based / Endpoint-based registration support
- Secondary proxy-server assignment function
- SIP signaling port change function
- SIP proxy server assignment according to the domain name
- T.38 real-time fax relay support
- DTMF relay support with RFC2833 / OPTION message
- Re-INVITE support

# VoIP (Voice over IP) Service

## AP-GS708S 8-Port GSM VoIP Gateway

- **Voice Codec**

- G.711 A-Law, G.711 U-Law
- G.726 r16, G.726 r32
- G.729A
- G.723.1 r63, G.723.1 r53
- VAD (Voice Activity Detection) function support
- DTMF relay support (H.323, SIP, MGCP common) based on RFC2833

- **RTP**

- Redundant RTP packet transmission in case of severe packet loss
- Dynamic jitter buffer management and RTP packet jitter and loss compensation with heuristic & DSP error concealment
- Static jitter buffer setting support
- Voice frame per RTP packet number control for each codec
- In-band ring-back tone support
- Virtual ring-back tone support
- Tone parameter change support

- **FAX**

- Fax relay mode supporting T.38, inband-T.38, bypass mode
- Lost packet compensation with redundant setting in case of T.38 fax relay
- Fax relay mode, rate setting for remote end

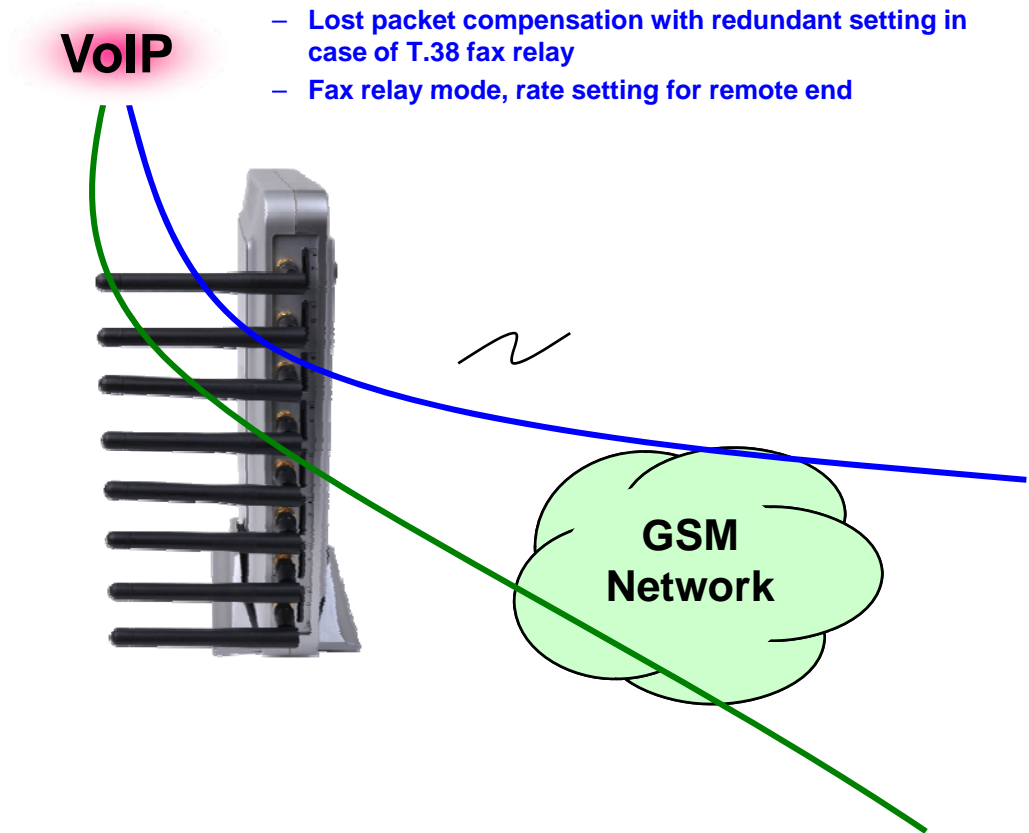

# VoIP (Voice over IP) Service

## AP-GS708S 8-Port GSM VoIP Gateway

### • VoIP Call Controls

- Hot line connection function with PLAR (Private Line Auto Ring Down)
- Leased line emulation function
- Connection monitoring function
- Fault tolerant with Redundancy and Call Distribution among Gateways for load balancing
- Call attempt with IP address
- H.323, SIP, MGCP inbound call connection for each voice port
- Multiple E.164 setting for one voice port
- One E.164 or digit pattern can be assigned to more than one voice port
- Hunting with Longest match/ priority/ sequence/ random
- One stage call setup by Digit forwarding
- Call barring with specific digit patterns
- Calling and called number conversion for PSTN outbound calls
- PSTN rerouting in case of VoIP call attempt failure

### • VoIP Call Controls (cont.)

- Call transfer for internal calls
- Call pickup for internal calls
- Calling and called number conversion for VoIP outbound calls
- Calling and called number conversion for VoIP inbound calls
- Fax broadcasting call control

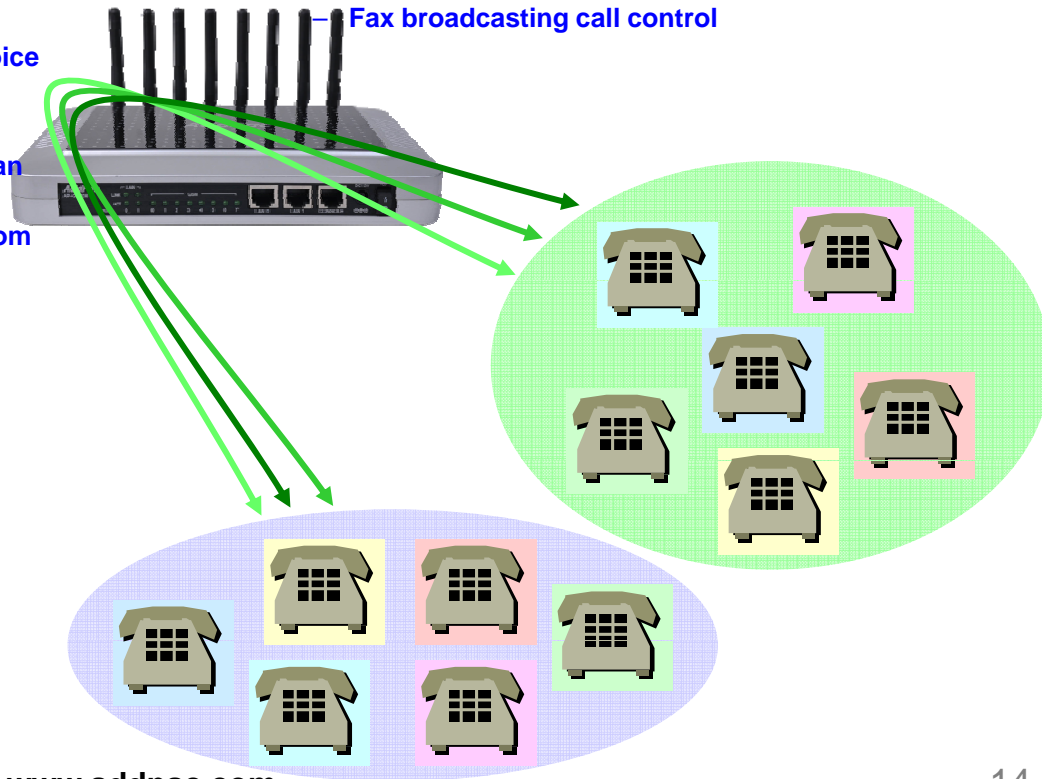

# Advanced QoS Features

## AP-GS708S 8-Port GSM VoIP Gateway

- Enhances **Transmit** Voice QoS Features
  - Voice Traffic Priority Queuing
  - QoS Service Profiling
  - Providing Virtual Network Transmit Algorithm
  - Real-time Voice Traffic QoS Support
  - RTP Packet Transmit Interval Control
  - Supporting RTP Packet Redundancy Scheme
  - IP Header Control such as ToS, Diffserv
- Enhances **Receive** Voice QoS Features
  - Dynamic Jitter Buffer Management
  - Error Concealment
  - Support T.38 FAX Data Error Recovery Scheme

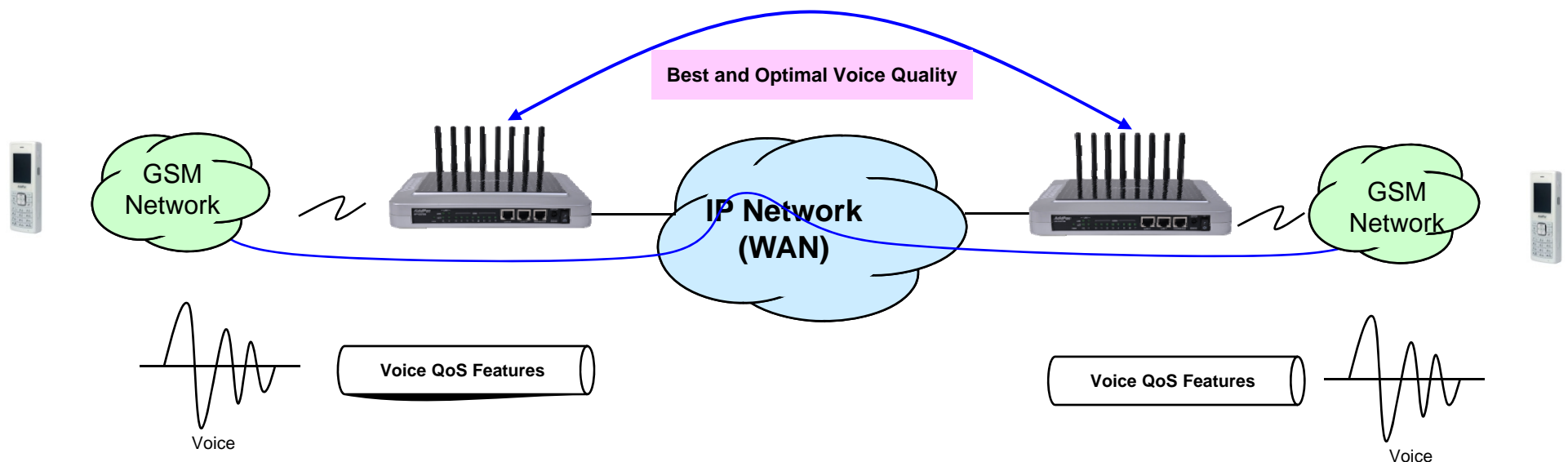

# Network Protocols

## AP-GS708S 8-Port GSM VoIP Gateway

- **Basic Network Protocols**
  - ARP, IPv4, TCP, UDP, ICMP, SCTP, IGMP, MLD
- **Routing Protocol**
  - IPv4 : Static
- **Service Protocol**
  - FTP, Telnet, TFTP, DHCP Server/Relay, SNMP Server
  - CDP (Cisco Discovery Protocol)
  - DNS Resolver, DDNS(nsupdate)
  - Bridge
  - Syslog
- **IPv4 Address Configuration**
  - Fixed (Static)
  - DHCP
  - PPPoE
- **Miscellaneous**
  - Cisco Style CLI
  - Standard & Extended IPv4 Access List
  - Multi-level User Account Management
  - IP accounting
  - STUN Client

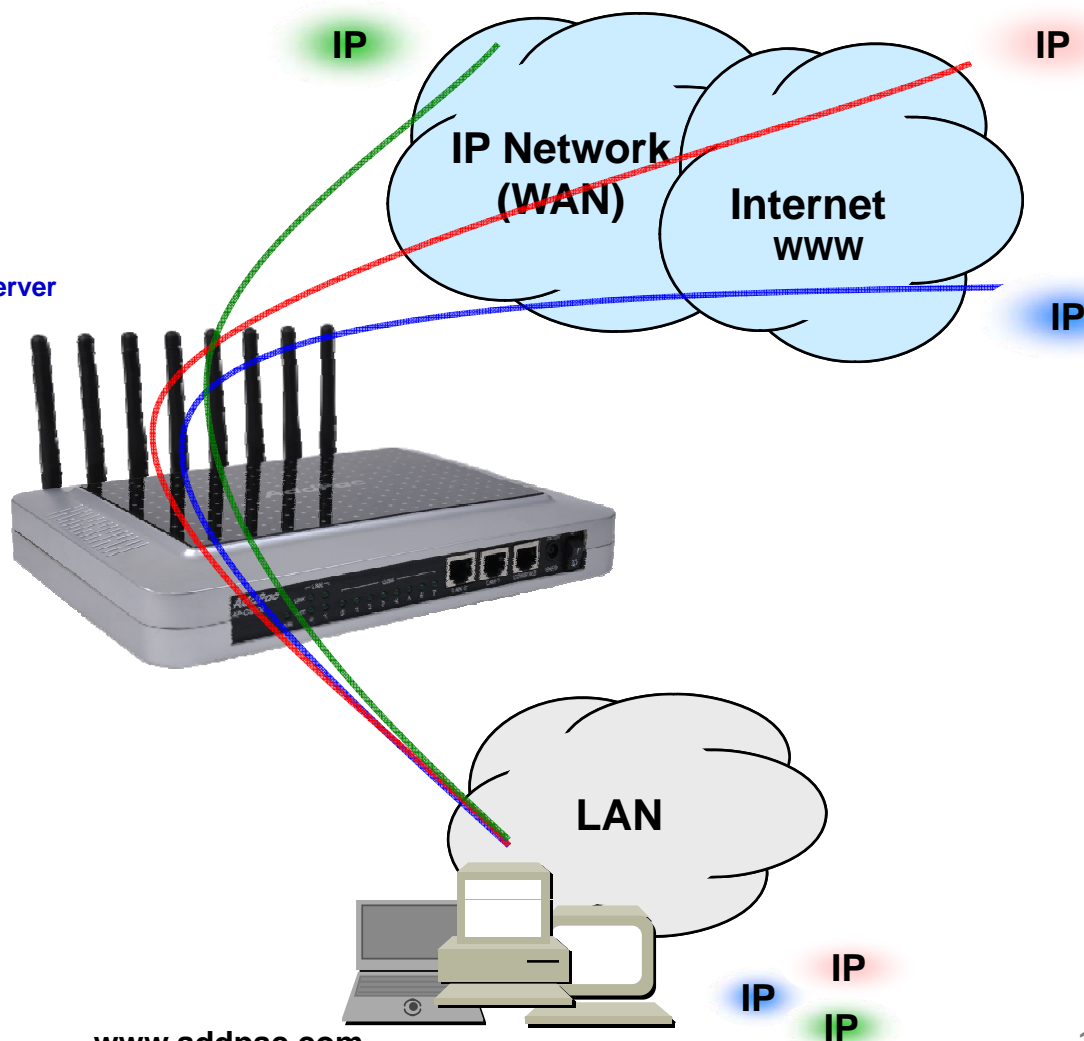



# Network Management

## AP-GS708S 8-Port GSM VoIP Gateway

- **SNMP**

- Standard Simple Network Management Protocol( SNMP) Agent support
- MIB v1 and v2 Support

- **Web-based Management**

- Smart Easy Setup
- Standard Voice Interface
- Standard PSTN Back-up Interface

- **Watch-dog Function**

- Hardware, Software watch-dog services

- **Remote Management**

- Telnet
- Rlogin

- **Auto Upgrade Service**

- HTTP server based APOS image and configuration file auto-upgrade support

- **Batch Job Function**

- Text based script downloading

- **Interoperable with AP-SNMS Service**

- AddPac Smart Network Management System

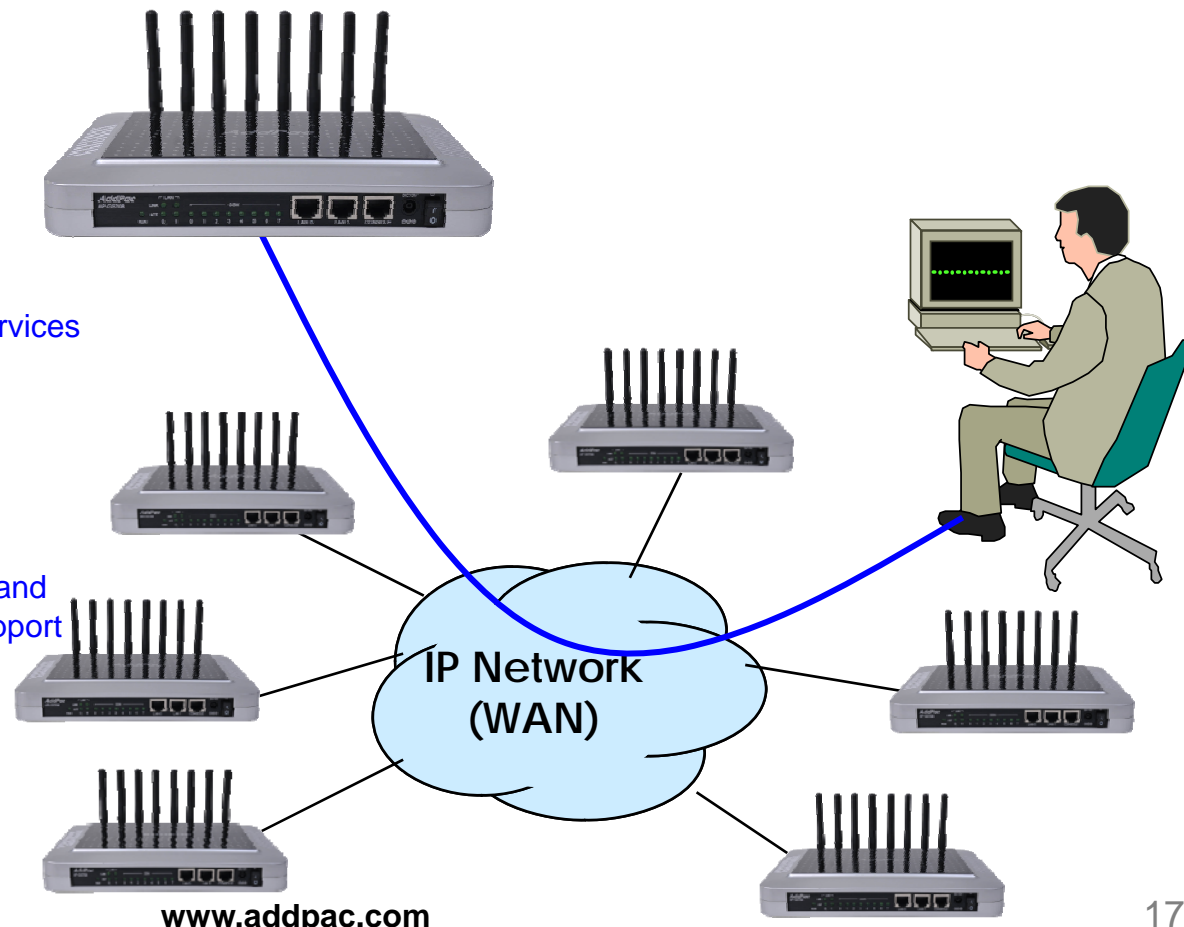

# Smart Web Manager : Main Page Layout

## AP-GS708S 8-Port GSM VoIP Gateway

**Main Menu**  
For easy system setup, provide the various menu and category

- System
  - Network Setup
  - Language
  - NTP
  - Backup/Restore
- Basic
  - Protocol
  - Server SIP
  - Server H.323
  - Tel Number
  - FXS/FXO/E1 Group
  - E1 Trunk
  - DTMF/CODEC
  - Dial Plan/Prefix
  - Static Route
  - Hot Line
- Advanced
  - Gain
  - Fax
  - Service
  - Filtering
  - Security
  - SNMP
- Miscellaneous
  - Call Status
  - System Status
  - Alarm Status
  - Call Log
  - System Log
  - Test Call
  - Ping

**Tool Bar**  
Provide frequently used tools like as System Update, Configuration Backup, Initialization, Restart, Telnet

**System Information**

HW Version	2.0
S/W Version	ap1800k_web_g2_v8_47T.bin 8.47
MAC Address	0002.a511.2245
VoIP Protocol	SIP
Voice Interface Module	S(4)O(4) : E1(2)
Registration Status	Unregistered
Supported Codec List	g711alaw g711ulaw g7231r53 g7231r63 g726r32 g729
Network Information	Static 172.16.50.114
WAN LINK Status	100Mbps FULL Duplex Link UP
LAN LINK Status	Link Down
Current Time	Thu Oct 1 13:06:23 2009
System Startup Time	Thu Oct 1 12:56:46 2009
System Running Time	0 days 00:09:37
Total Calls	0

**Information**  
Display the current system version and status summary

**Information**

AddPac Tehonology  
Model : AP1800K\_G2  
HW Version : 2.0  
S/W Version : 8.47  
Smart Web Version : 0.3  
Smart Web Build : Oct 1 2009  
Voice Interface  
S(4)O(4) : E1(2)  
Protocol : SIP  
Status : Unregistered  
CurrentCalls : 0 Call  
Network : Static 172.16.50.114  
Mac Address: 0002.a511.2245

**Description**

WAN 포트에 대한 설정입니다. Static IP의 경우 고정 IP 주소로 사업자로 부터 할당 받은 주소 정보를 입력합니다. DHCP와 PPPoE의 경우 유동 IP로 장비의 주소가 변경될 수 있습니다. DHCP 및 PPPoE는 사용자 환경에 맞도록 설정하십시오. MAC 주소 변경은 필요시 장비에 설정된 주소를 사용하지 않고사용자가 설정한 주소를 사용하는 방안으로 반드시 필요한 경우에 한하여 사용하여야 합니다.

**Workspace**  
Workspace for detailed action

**Description**  
Display the help message if you move mouse over main menu

©AddPac Tehonology 2008-2009. all rights reserved.

# Smart Web Manager : SIP Server (Example)

AP-GS708S 8-Port GSM VoIP Gateway

**Smart Web Manager**  
www.addpac.com

**SIP (Session Initiation Protocol)**

Use SIP Server  Yes  No

Primary SIP Server   Server address (IP or Domain Name) and Port (default 5060)

Secondary SIP Server   Server address (IP or Domain Name) and Port (default 5060)

Local Domain name  (SIP userpart of authentication)

SIP Signaling Port  (default 5060, between 1 to 65535)

Register Expiration  (in seconds, default 60, between 10 to 86400)

Session Re-Fresh  INVITE  UPDATE

Session Expire Time  (in seconds, default 1800, between 30 to 86400, 0 = disable)

Apply

**SIP Server**  
Primary & Secondary server,  
Local domain name,  
SIP Signaling Port ( **reboot necessary** )  
Timer  
\* register expire  
\* session refresh  
\* session expire

**Information**  
AddPac Technology  
Model : GS1002\_G2  
H/W Version : 2.0  
S/W Version : 8.00d  
Smart Web Version : 0.4  
Smart Web Build : Mar 24 2010  
Voice Interface  
G(2)S(2)  
Protocol : SIP  
Status : Unregistered  
CurrentCalls : 0 Call  
Network : Static 172.16.9.16  
Mac Address : 0002.a400.0000  
Unread Message:  
P0:0(0)  
P0:1(0)

**Description**  
Configure the settings for SIP.  
Contact your service provider  
for the settings

# Smart Web Manager : GSM Extension (Example)

## AP-GS708S 8-Port GSM VoIP Gateway

**Smart Web Manager**  
www.addpac.com

**System**

- Network Setup
- Language
- NAT
- PPTP

**System**

- Server SIP
- SIP Registration
- FXS Extension
- **GSM Extension**

**Advanced**

- Gain & CID
- GSM PINs
- Fax
- Service
- Filtering
- Security
- SNMP
- WEB Callback
- GSM Callback

**Miscellaneous**

- Call Status
- System Status
- Alarm Status
- GSM Status
- Call Log
- System Log
- Ping
- BTS Selection
- GSM BTS Info

### GSM Extension

**Port Information**

Port	P0	P1	P2	P3
SLOT0	GSM	GSM	FXS	FXS

**GSM Extension Configuration**

Index	Port	Numbers	Preference	HuntStop	Select
0	0/0	T	0	X	<input type="checkbox"/>

**GSM Extension with Translation**

Port	Destination Pattern	Digits to Insert	Number of Digits to Delete
P0:0	33	8	1
P0:1			0

**Information**

AddPac Technology  
Model : GS1002\_G2  
HW Version : 2.0  
SW Version : 8.00d  
Smart Web Version : 0.4  
Smart Web Build : Mar 24 2010  
Voice Interface  
G(2)S(2)  
Protocol : SIP  
Status : Unregistered  
CurrentCalls : 0 Call  
Network : Static 172.16.9.16  
Mac Address : 0002.a400.0000  
Unread Message:  
P0:0(0)  
P0:1(0)

**Description**

Set up for using GSM port to extension number (forwarding No)

**Port Information**  
voice port type & physical port

**GSM Extension**  
Configure GSM phone-number for receiving a call  
(usually 'T' is used for each port)

**GSM Extension with Translation**  
Used to GSM callback  
- The Received CID is not real serving number.  
- The specified translation rule is applied.

# Security Management

## AP-GS708S 8-Port GSM VoIP Gateway

- IP packet filtering
- IP access list
- User authentication function
  - Password Authentication Protocol (PAP)
  - Challenge Handshake Authentication Protocol (CHAP)
- Enable/Disable specific protocols
- Auto-square connect of Telnet session
- Account Management function for multi-level user
- SNMP/TELNET/FTP/HTTP/TFTP port assignment function
- SNMP/TELNET/FTP access list management
- Boot mode security checking function

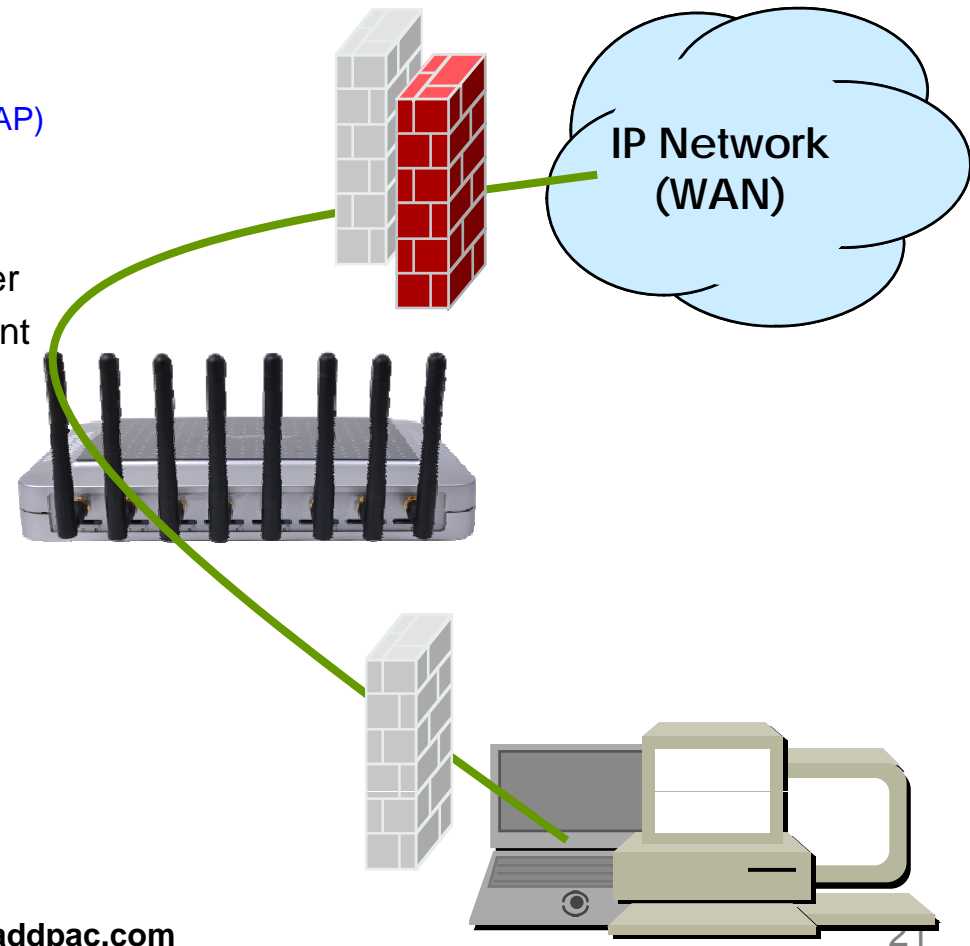

# Standard Application

## AP-GS708S 8-Port GSM VoIP Gateway

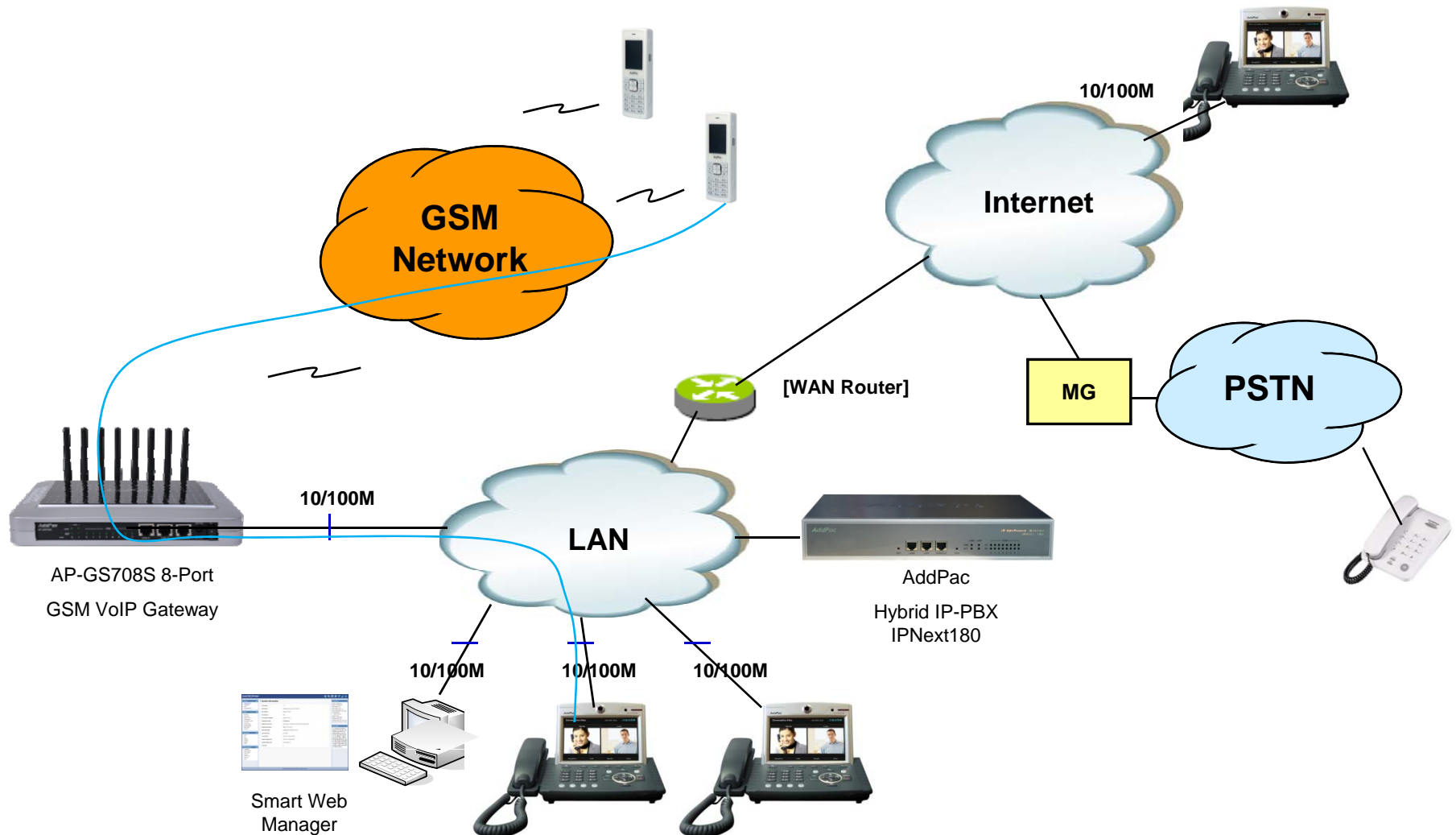

**AddPac**

[www.addpac.com](http://www.addpac.com)

# Ordering Information

- **AP-GS708S GSM Gateway Hardware**
  - AP-GS708S GSM VoIP Gateway Main Body
  - RISC Microprocessor with High-end Programmable DSP Architecture
  - 2-port 10/100Mbps Fast Ethernet(RJ45)
  - 1-Port RS232C Console Interface(RJ45)
  - Including Network Cable, Antenna, etc.
- **Built-in APOS Internetworking Software for AP-GS708S**
- **Including 1 Year Hardware Warranty**
- **Product Documents**
  - Install and Operation Guide (PDF)
- **Pricing**
  - AddPac Technology Regional Sales Manager
  - Authorized Sales and Marketing Representatives
  - Please Contact [www.addpac.com](http://www.addpac.com)

# GSM Gateway Series

# Thank you!

**AddPac Technology Co., Ltd.**  
Sales and Marketing

Phone +82.2.568.3848 (KOREA)

FAX +82.2.568.3847 (KOREA)

E-mail [sales@addpac.com](mailto:sales@addpac.com)