

# AP5800 (256 Port) Large Scale VoIP Gateway

High Performance VoIP Gateway Solution

Preliminary Product Overview



**AddPac**

**AddPac Technology**

Sales and Marketing

[www.addpac.com](http://www.addpac.com)

# Contents

- Product Overview
- Hardware Specification
- APOS Technology
- VoIP (Voice over IP) service
- Advanced QoS Features
- Network Protocols
- Network Management
- Security Management
- VPMS VoIP Management
- Application Service
- Ordering Information



# Product Overview

## AP5800 Large Scale VoIP Gateway

- H.323/SIP/MGCP Concurrent Stack Embedded
- High Performance RISC Microprocessor for System Control
- Dual Power Redundancy (AC, DC ) selectable at ordering
- Optional Dual CPU Board Support for Active, Standby System Redundancy
- Hot-Swap Function Support
- Up to 256 Analog Interface Port (32Port Board x 8 ea) Support
- Two(2) 10/100/1000Mbps Giga-bit Ethernet Interface
- G.711/G.726/G.723/G.729, T.38 Fax , VAD, etc
- Powerful Network Protocols (PPPoE, DHCP, Static Routing, etc)
- Firmware Upgradeable Architecture
- VPMS (VoIP Plug&Play Management System) for Large Scale Deployment
- Advanced Voice QoS Mechanism

# Product Highlights

## AP5800 Large Scale VoIP Gateway

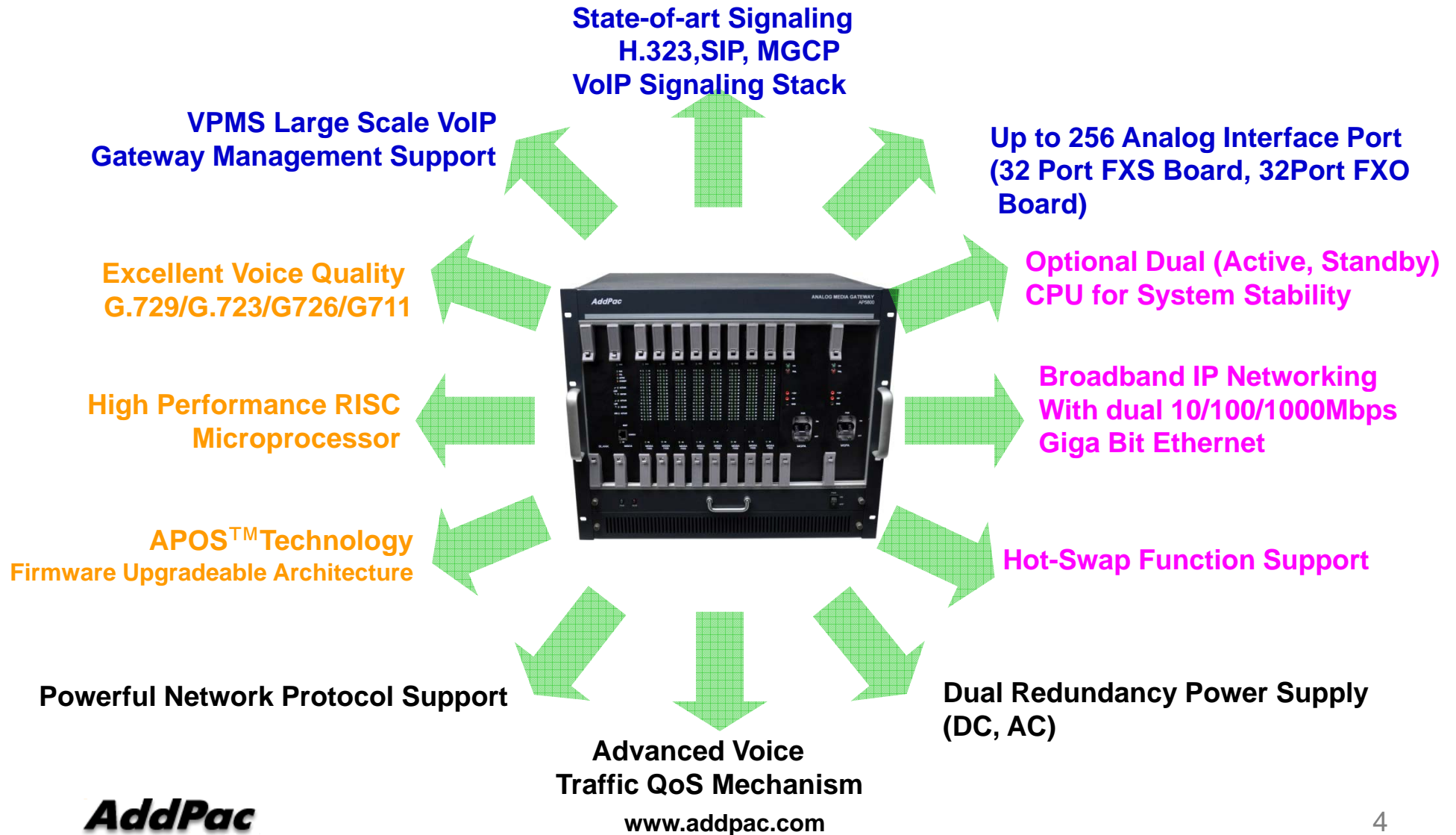

# APOS Technology

AP5800 Large Scale VoIP Gateway

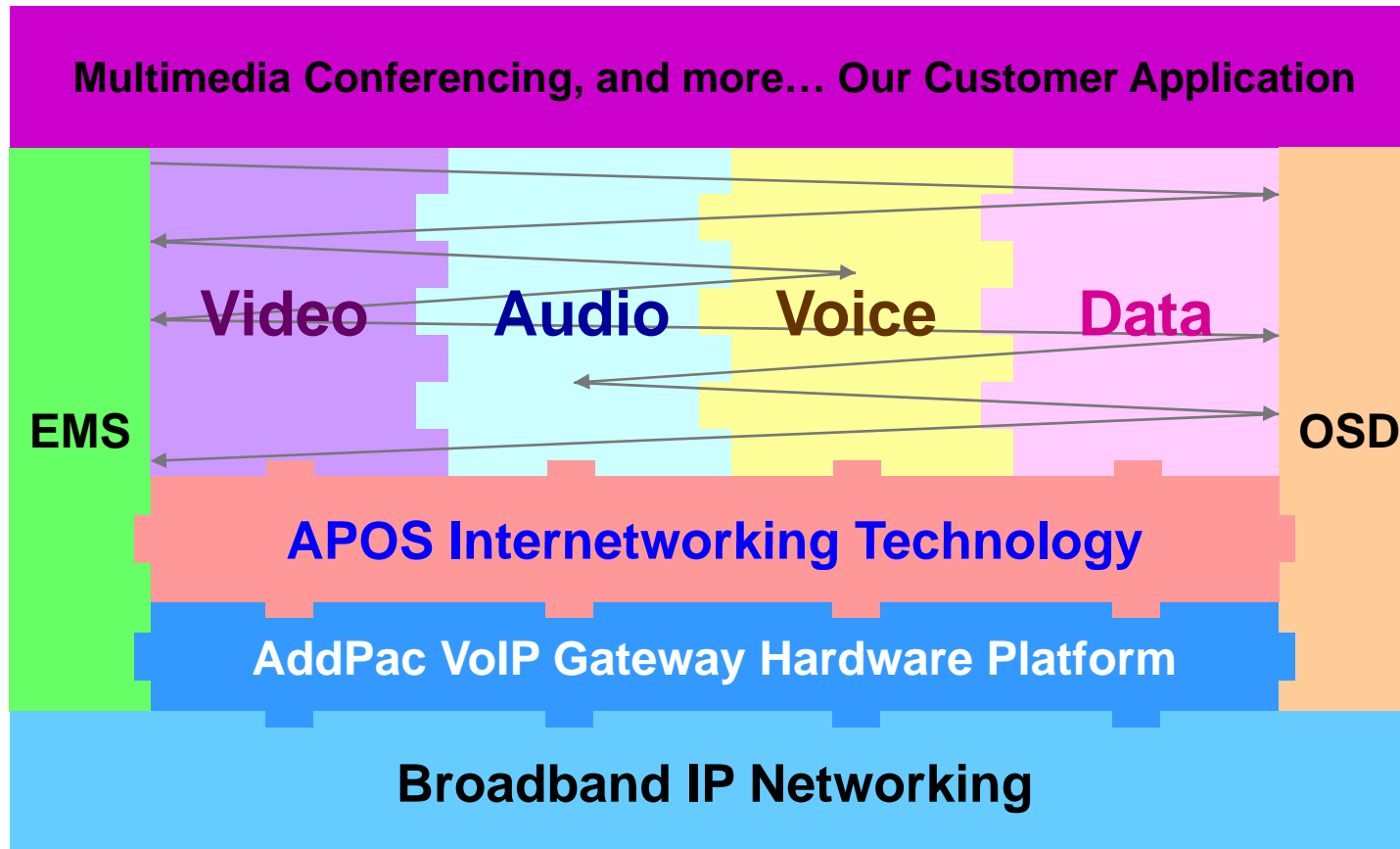

- APOS : AddPac Internetworking Operating System
- OSD : On- Screen Display
- EMS : Element Management System

# Hardware Specification

## AP5800 Large Scale VoIP Gateway

RISC  
CPU

High-end  
DSP



- Console Port
- Standby CPU (Option)
- Active CPU
- 32Port FXS Board
- FAN Tray
- Power Module A
- Power Module B



- AC Power Input
- 32-Port Analog Interface Connector
- Gigabit Ethernet Interface

**AddPac**

[www.addpac.com](http://www.addpac.com)

# Hardware Specification

## AP5800 Large Scale VoIP Gateway

### Hardware Specifications

<b>AP5800 VoIP Gateway</b>	<b>Basic Specifications</b>
<b>CPU</b>	High-End RISC Microprocessor Option : Dual Redundancy CPU (Active, Standby)
<b>Voice Interface</b>	Up to 256-Port FXS Voice Interface Up to 256-Port FXO Voice Interface
	32-Port Analog FXS Board, FXO Board
<b>Ethernet Interface</b>	2-Ports 10/100/1000Mbps Gigabit Ethernet Interface(RJ-45)
<b>Flash Memory/CPU</b>	512Mbyte NAND Flash Memory
<b>Base Memory/CPU</b>	1Gbyte High Speed DDR2
<b>Power Requirement</b>	Dual Power Supply / VAC 110~220V, 50/60Hz, 880Watt
<b>Operating Temperature</b>	0°C ~ 45°C (32 °F ~ 122°F)
<b>Storage Temperature</b>	-40°C ~ 85°C (-40°C ~ 185°F)
<b>Relative Humidity</b>	5% ~ 95% (Non-condensing)
<b>Dimensions</b>	400mm x 482mm x 340mm (H x W x D)



# Hardware Specification : AP5800 Modules

AP5800 Large Scale VoIP Gateway

## **MGCA**

Media Gateway Control Board Assembly



## **MGSA-32FXS**

Media Gateway Subscriber Board Assembly  
: 32-Port FXS for Long Distance

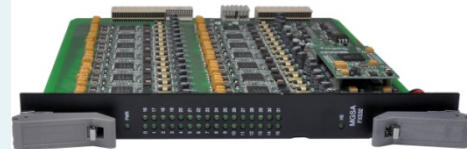

## **MGSA-32FXS-N1**

Media Gateway Subscriber Board Assembly

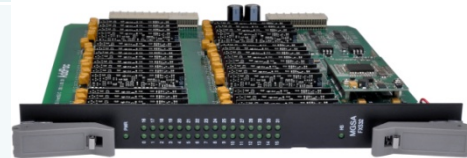

## **MGSA-32FXO**

Media Gateway Subscriber Board Assembly  
: 32-Port FXO

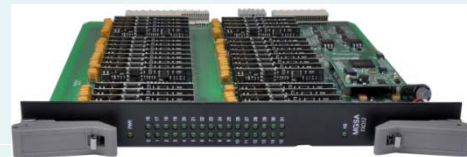

## **MGPA**

Media Gateway Power Supply Assembly





# VoIP (Voice over IP) Service

## AP5800 Large Scale VoIP Gateway

- **H.323, SIP, and MGCP VoIP Signaling Stack**
- **H.323**
  - ITU-T Standard H.323 v3 Support
  - Support H.245 Tunneling
  - Including H.235 Security Features
- **SIP**
  - IETF RFC3261 or RFC2543 SIP Standard
- **MGCP**
  - IETF RFC2705bis-02 Standard MGCP 1.0

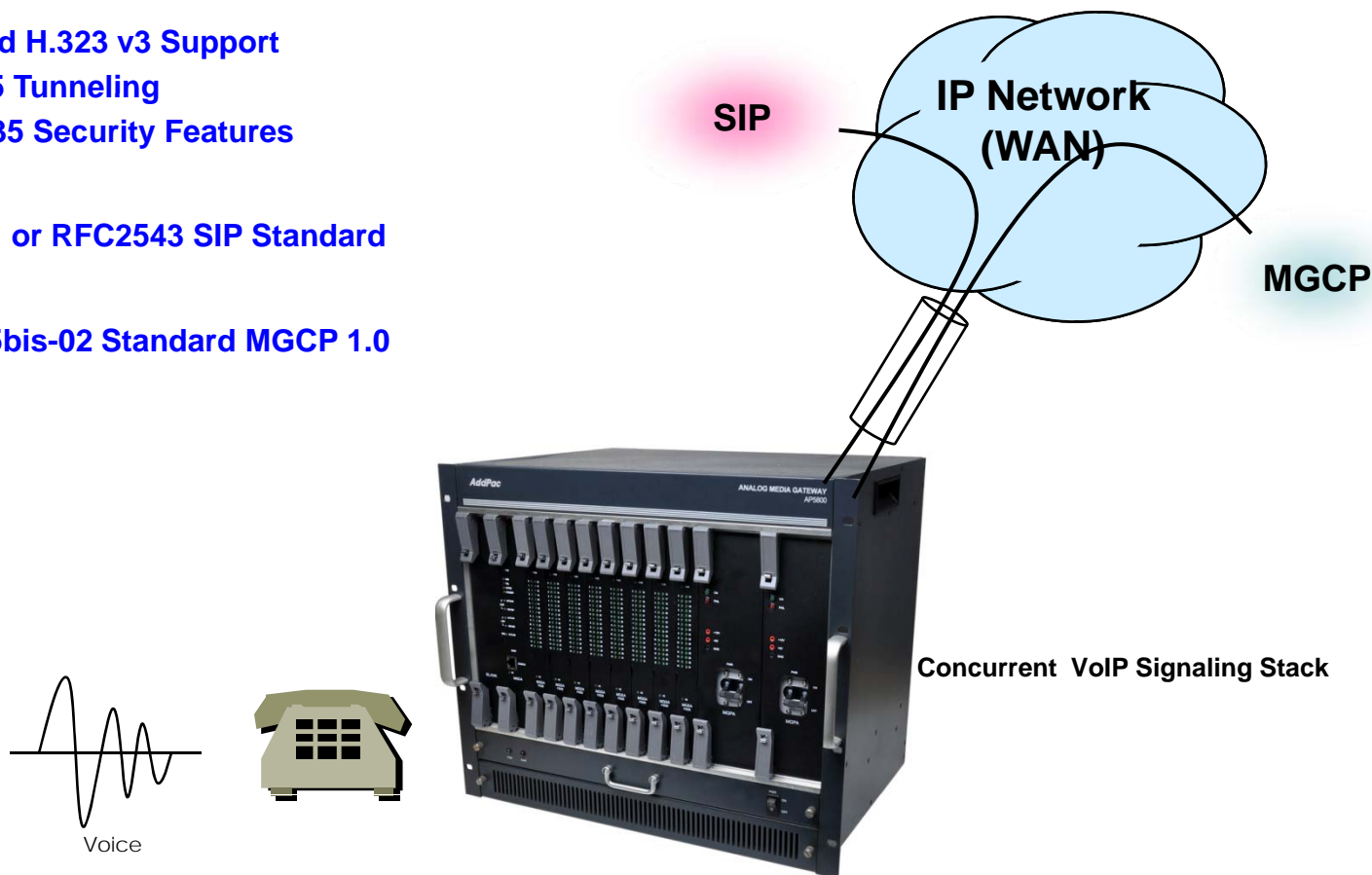

# VoIP (Voice over IP) Service

## AP5800 Large Scale VoIP Gateway

- **H.323**

- Fast connect, normal connect support
- H.245 tunneling support
- Q.931 response message setting for inbound VoIP calls
- H.245 logical channel open timing selection function
- Start H.245 procedure support
- DTMF / Hook flash relay with H.245 alphanumeric / signal
- Secondary gatekeeper support
- Gatekeeper assignment according to the domain name
- Gatekeeper discovery with multicast
- Lightweight RRQ support
- Signaling TCP port assignment
- Resource threshold setting with RAI
- H.235 clear-token, crypto-token support
- canMapAlias support
- Technical prefix (supported prefix) support
- Public IP assignment in NAT environment

- **SIP**

- Gateway-based / Endpoint-based registration support
- Secondary proxy-server assignment function
- SIP signaling port change function
- SIP proxy server assignment according to the domain name
- T.38 real-time fax relay support
- DTMF relay support with RFC2833 / OPTION message
- Re-INVITE support

- **MGCP**

- Secondary call agent assignment function
- Default package assignment
- Announcement Server Package, Generic Media Package, Handset Package, Line Package, Trunk Package support
- MGCP call agent assignment according to the domain name
- T.38 real-time fax relay support
- DTMF relay support based on RFC2833

# VoIP (Voice over IP) Service

## AP5800 Large Scale VoIP Gateway

- **Voice Codec**

- G.711 A-Law, G.711 U-Law
- G.726 r16, G.726 r32
- G.729A
- G.723.1 r63, G.723.1 r53
- VAD (Voice Activity Detection) function support
- DTMF relay support (H.323, SIP, MGCP common) based on RFC2833

- **RTP**

- Redundant RTP packet transmission in case of severe packet loss
- Dynamic jitter buffer management and RTP packet jitter and loss compensation with heuristic & DSP error concealment
- Static jitter buffer setting support
- Voice frame per RTP packet number control for each codec
- In-band ring-back tone support
- Virtual ring-back tone support
- Tone parameter change support

- **FAX**

- Fax relay mode supporting T.38, inband-T.38, bypass mode
- Lost packet compensation with redundant setting in case of T.38 fax relay
- Fax relay mode, rate setting for remote end

VoIP

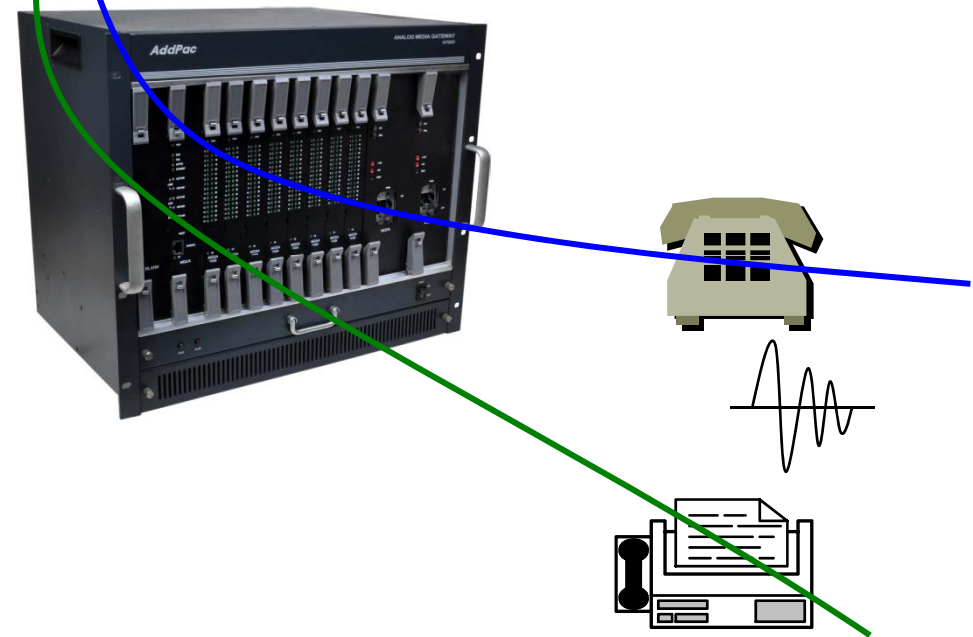

# VoIP (Voice over IP) Service

## AP5800 Large Scale VoIP Gateway

### • VoIP Call Controls

- Hot line connection function with PLAR (Private Line Auto Ring Down)
- Leased line emulation function
- Connection monitoring function
- Fault tolerant with Redundancy and Call Distribution among Gateways for load balancing
- Call attempt with IP address
- SIP, MGCP inbound call connection for each voice port
- Multiple E.164 setting for one voice port
- One E.164 or digit pattern can be assigned to more than one voice port
- Hunting with Longest match/ priority/ sequence/ random
- One stage call setup by Digit forwarding
- Call barring with specific digit patterns
- Calling and called number conversion for PSTN outbound calls
- PSTN rerouting in case of VoIP call attempt failure

### • VoIP Call Controls (cont.)

- Call transfer for internal calls
- Call pickup for internal calls
- Calling and called number conversion for VoIP outbound calls
- Calling and called number conversion for VoIP inbound calls
- Fax broadcasting call control

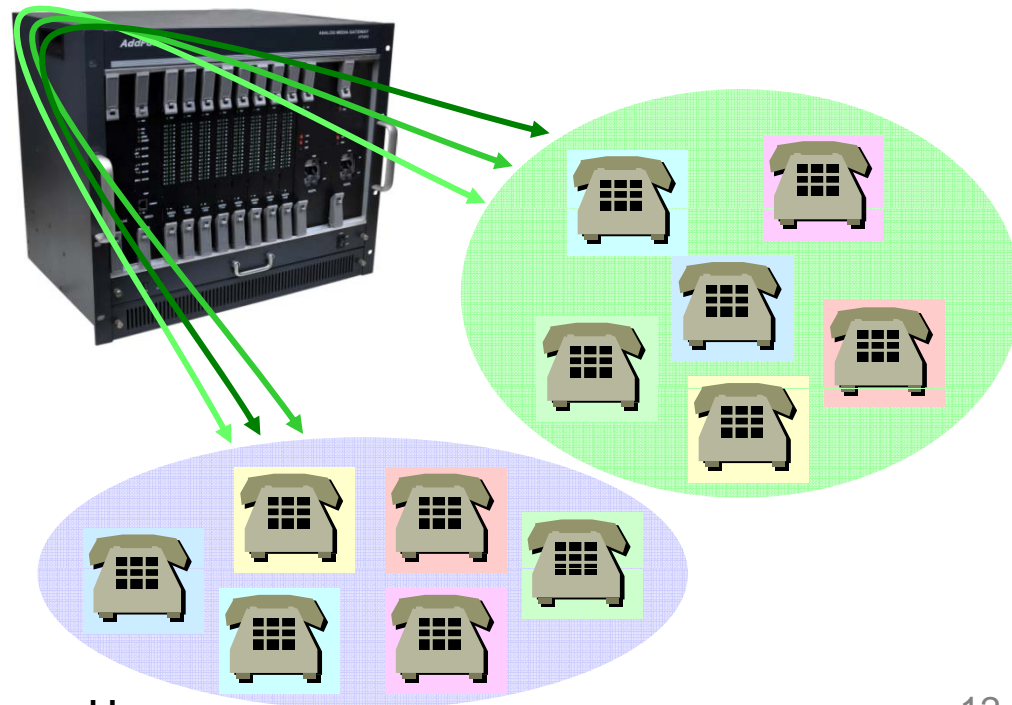

# Advanced QoS Features

## AP5800 Large Scale VoIP Gateway

- Enhances **Transmit** Voice QoS Features
  - Voice Traffic Priority Queuing
  - QoS Service Profiling
  - Providing Virtual Network Transmit Algorithm
  - Real-time Voice Traffic QoS Support
  - RTP Packet Transmit Interval Control
  - Supporting RTP Packet Redundancy Scheme
  - IP Header Control such as ToS, Diffserv
- Enhances **Receive** Voice QoS Features
  - Dynamic Jitter Buffer Management
  - Error Concealment
  - Support T.38 FAX Data Error Recovery Scheme

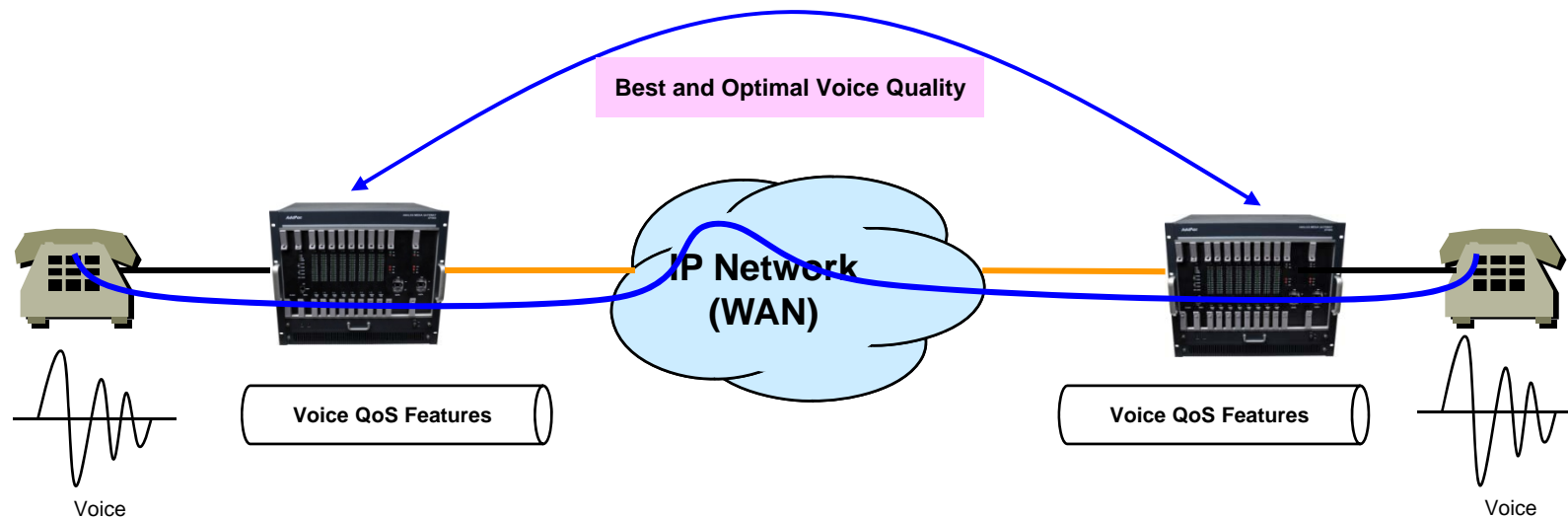

# Network Protocols

## AP5800 Large Scale VoIP Gateway

### Basic Network Protocols

- ARP, IPv4, TCP, UDP, ICMP, SCTP, IGMP, MLD

### Routing Protocol

- IPv4 : Static

### Service Protocol

- FTP, Telnet, TFTP, DHCP Server/Relay, SNMP Server
- CDP (Cisco Discovery Protocol)
- DNS Resolver , DDNS(nsupdate)
- Bridge
- Syslog

### IPv4 Address Configuration

- Fixed (Static)
- DHCP
- PPPoE

### Miscellaneous

- Cisco Style CLI
- Standard & Extended IPv4 Access List
- Multi-level User Account Management
- IP accounting
- STUN Client

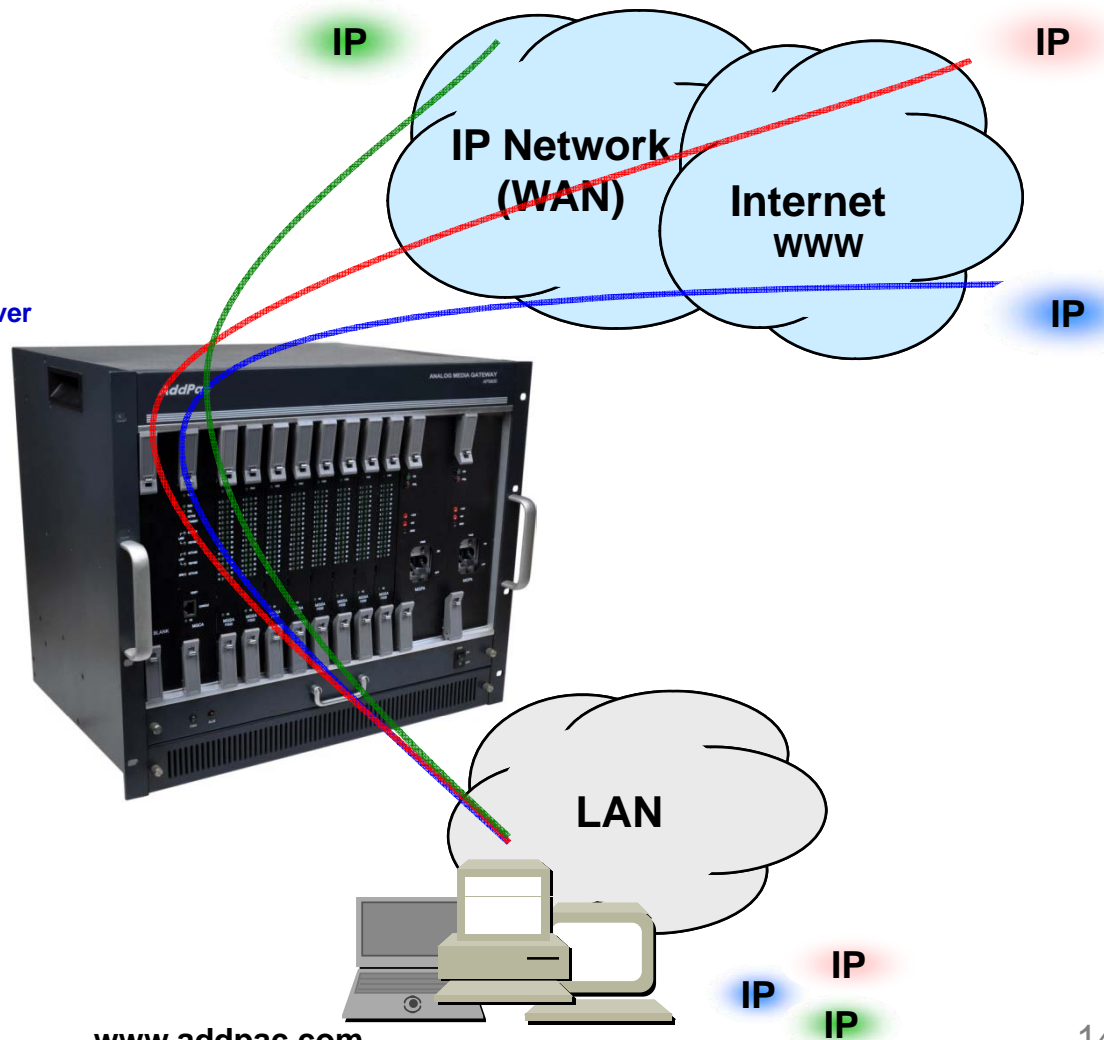

# Network Management

## AP5800 Large Scale VoIP Gateway

- **SNMP**
  - Standard Simple Network Management Protocol( SNMP) Agent support
  - MIB v1 and v2 Support
- **Watch-dog Function**
  - Hardware, Software watch-dog services
- **Remote Management**
  - Telnet
  - Rlogin
- **Auto Upgrade Service**
  - HTTP server based APOS image and configuration file auto-upgrade support
- **Batch Job Function**
  - Text based script downloading
- **Interoperable with AP-VPMS Service**
  - AddPac VoIP Plug & Play Management System (AP-VPMS)

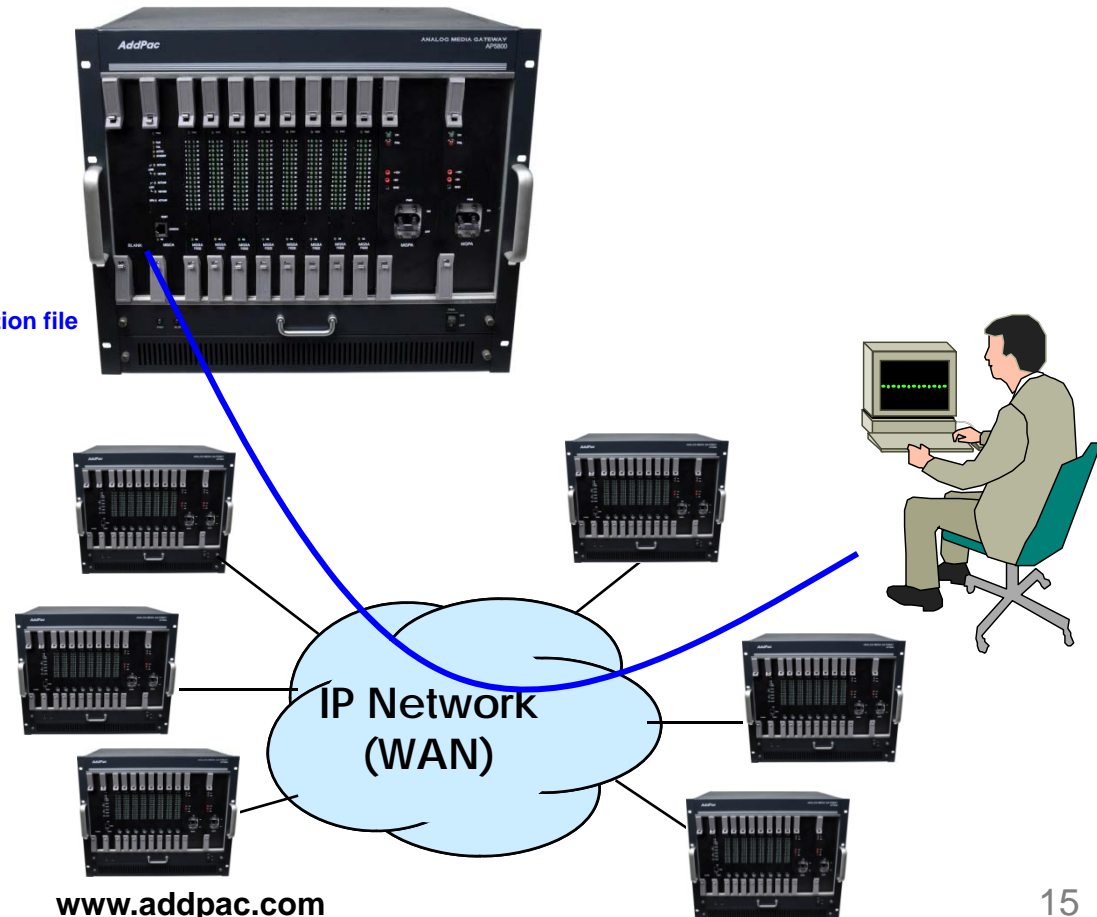



# Security Management

## AP5800 Large Scale VoIP Gateway

- IP packet filtering
- IP access list
- User authentication function
  - Password Authentication Protocol (PAP)
  - Challenge Handshake Authentication Protocol (CHAP)
- Enable/Disable specific protocols
- Auto-square connect of Telnet session
- Account Management function for multi-level user
- SNMP/TELNET/FTP/HTTP/TFTP port assignment function
- SNMP/TELNET/FTP access list management
- Boot mode security checking function

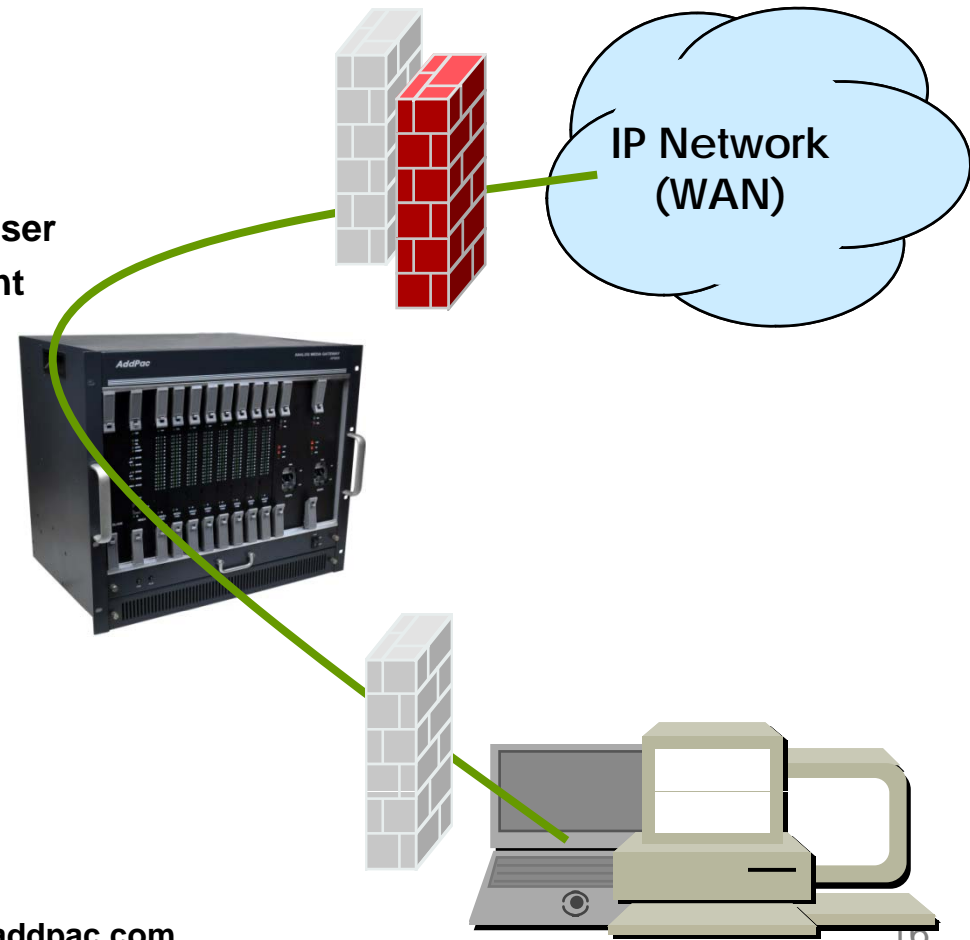

# VPMS (VoIP Plug&Play Management System)

## AP5800 Large Scale VoIP Gateway

- **AddPac AP-VPMS Support**
  - AddPac VoIP Plug & Play System (VPMS)
  - Best EMS Solutions for AddPac VoIP G/W
- **Requirements Hardware Platform**
  - Over 1GHz Intel Pentium 4 Machine
  - Over 1GB Main Memory
  - Over 40GB Hard Disk Memory
  - Microsoft Windows Advanced Server or Windows 2000 Server or Windows XP Professional
  - DBMS : Microsoft MS-SQL Server 2000

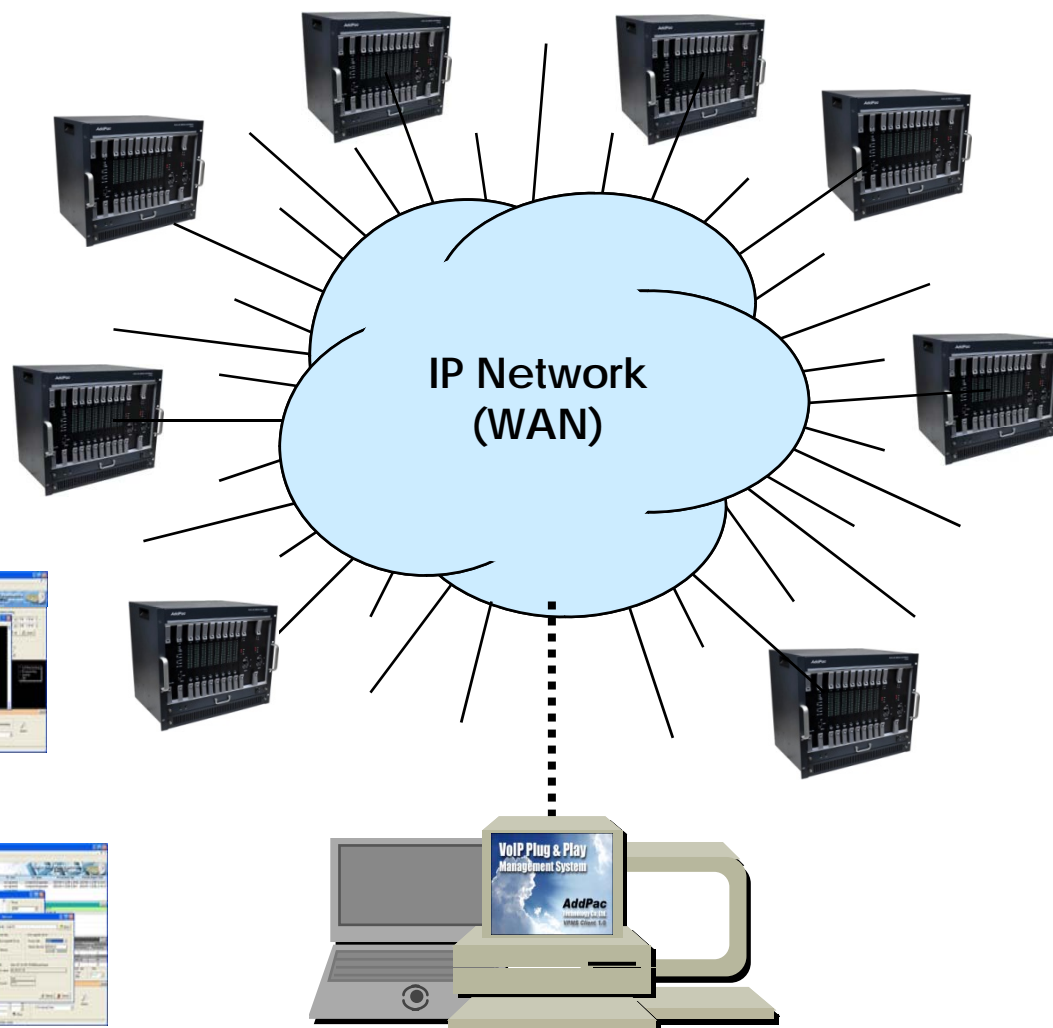

# Standard Application

## AP5800 Large Scale VoIP Gateway

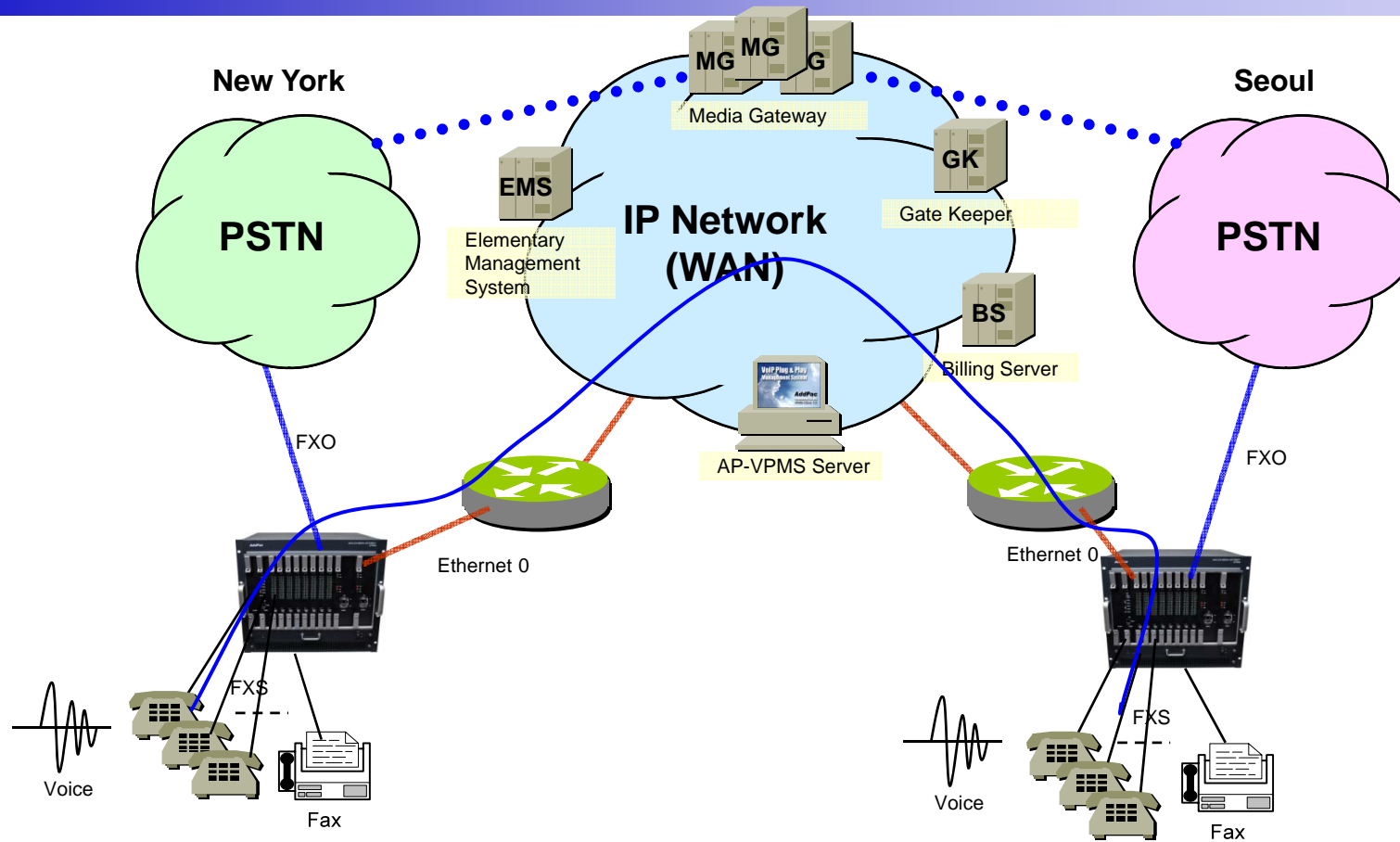

 FXS Analog Voice Interface

 FXO Analog Voice Interface

 Voice+Data. Ethernet or WAN Interface

 TRUNK n x E1 Voice Interface for PSTN Interworking



Leased Line/ATM/Frame-Relay/IP Router, xDSL/Cable Modem, etc.



AddPac AP5800 Media Gateway



Analog Phone

# Ordering Information

- **AP5800 VoIP Gateway Hardware**
  - AP5800 VoIP Gateway Main Body
  - Single CPU, Dual Power Supply
  - 128 Port/256 Port FXS, FXO Interface Configuration
  - Including Network Cable & Power Supply, etc.
- **Built-in APOS Internetworking Software for AP5800**
- **Including 1 Year Hardware Warranty**
- **Product Documents**
  - Install and Operation Guide (PDF)
- **Pricing**
  - AddPac Technology Regional Sales Manager
  - Authorized Sales and Marketing Representatives
  - Please Contact [www.addpac.com](http://www.addpac.com)

# VoIP Gateway Series

# Thank you!

**AddPac Technology Co., Ltd.**  
Sales and Marketing

Phone +82.2.568.3848 (KOREA)

FAX +82.2.568.3847 (KOREA)

E-mail [sales@addpac.com](mailto:sales@addpac.com)