

# IP Telephony Solution for Train Traffic Control Center (General Train)



**AddPac**

**AddPac Technology**

Sales and Marketing

[www.addpac.com](http://www.addpac.com)

# Contents

- IP Telephony Network Diagram for General Train Traffic Control Center (Korail)
- IP Telephony Solution Components (Example)
  - AP6800 Large Scale VoIP Gateway (Long Distance Support)
  - IPNext3000 Call Manager
  - AP-NR2000L IP Voice Recording Server
  - AP-MC1500 Voice MCU
  - AP2620 VoIP Gateway with Voice Recording Feature
  - AP-IP300 IP Phone
  - AP-PT50 Extend Speed-Dial Box
  - AP-SAC Smart Attendant Console
  - AP-SNMS Smart IP Telephony NMS

# IP Telephony Network Diagram for Korail(cont..)

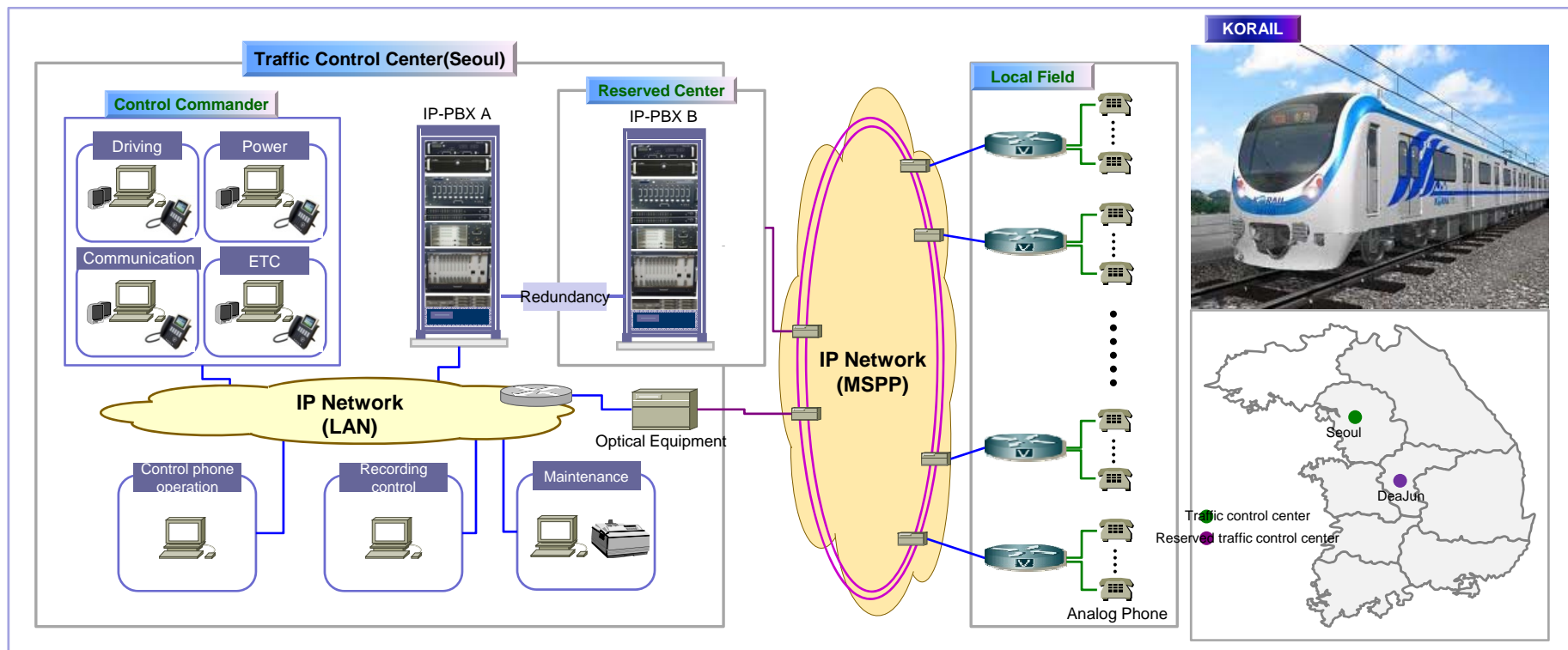

# IP Telephony Network Diagram for Korail

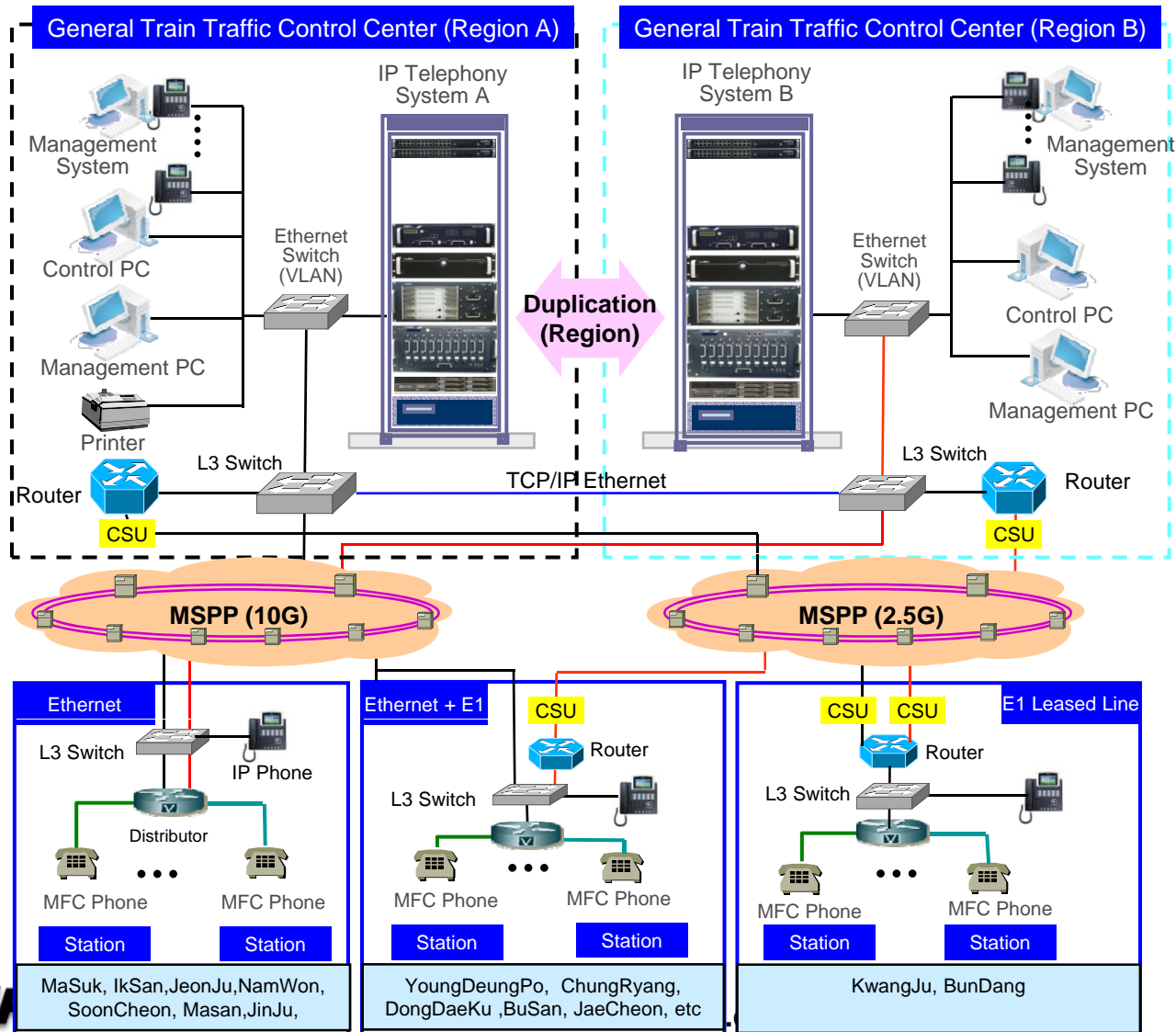

**Add**





# IP Telephony Solution Components



# AP6800 VoIP Gateway

(Large Scale, Long Distance)

# Large Capacity VoIP Gateways

Product	AP6500	AP6800
		
Available VoIP Modules	AP-N1-FXS32 AP-N1-FXO32	AP-N1-FXS32 AP-N1-FXO32
Analog Ports	Up to 128 (32-Port Module x 4)	Up to 256 (32-Port Module x 8)
Signaling	SIP, H.323	SIP, H.323
CPU Redundancy (Dual CPU)	Support (Option)	Support (Option)
E&M	N/A	N/A
Module Slot for VoIP Module	4 Slots	8 Slots
LAN Port	2	2
Console	1	1
Dual Power Supply (Option)	Support	Support

# Main Features

## AP6800 Large Scale VoIP Gateway

- SIP/MGCP Concurrent **Redundancy** Stack Embedded
- High Performance RISC Processor
- Dual CPU Redundancy (Active, Standby) for System Stability
- Dual Power Redundancy (AC, DC ) selectable at ordering
- Hot-Swap Function Support
- Up to 256 Analog Interface Port (32Port Board x 8 Ea) Support
- Two(2) 10/100/1000Mbps Giga-Bit Ethernet Interface
- G.711/G.726/G.723/G.729, T.38 Fax , VAD, etc
- Powerful Network Protocols (PPPoE, DHCP, Static Routing, etc)
- Firmware Upgradeable Architecture
- VPMS (VoIP Plug&Play Management System) for Large Scale Deployment
- Advanced Voice QoS Mechanism



# Hardware Specification

## AP6800 Large Scale VoIP Gateway

RISC  
CPU

High-end  
DSP



Console Port

Active CPU

Standby CPU

32Port FXS Board

Power Module A

Power Module B

FAN Tray

AC Power Input

32 Port Analog Interface Connector

Giga Ethernet Interface

**AddPac**

[www.addpac.com](http://www.addpac.com)

# Hardware Specification

## AP6800 Large Scale VoIP Gateway

RISC  
CPU

High-end  
DSP

### Hardware Specifications

AP6800 VoIP Gateway	Basic Specifications
Dual Redundancy CPU	High-End RISC Microprocessor, Dual Redundancy CPU (Active, Standby)
Voice Interface	Up to 256-Port FXS Voice Interface Up to 256-Port FXO Voice Interface
	32-Port Analog FXS Board, FXO Board
Ethernet Interface	2-Ports 10/100/1000Mbps Giga Ethernet Interface(RJ-45)
Flash Memory/CPU	8Mbyte High-speed Flash Memory
Base Memory/CPU	64/128Mbyte High-speed SDRAM
Power Requirement	Dual Power Supply / VAC 110~220V, 50/60Hz, 880Watt
Operating Temperature	0°C ~ 45°C (32 °F ~ 122°F)
Storage Temperature	-40°C ~ 85°C (-40°C ~ 185°F)
Relative Humidity	5% ~ 95% (Non-condensing)
Dimensions	400mm x 482mm x 340mm (H x W x D)



CPU Board

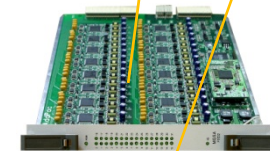

32Port  
FXS Board



Power Supply  
Board

# IPNext3000 Call Manager



# Main Features

## IPNext3000 Call Manager

- IP based Advanced PBX Solution
- IPv4/IPv6 based Dual Network Protocol Support
- Internal/External RTP Proxy Function Support
  - External RTP Proxy Server for Private Address : AP-RS2000
- Internal/External Presence Function Support with Smart Messenger
  - External Presence Server : AP-PS2000
- Powerful Management and User Friendly Features
- Fault Tolerant and Scalability Architecture
- High-performance Video, Audio, and Voice Service
- Firmware Upgradeable Architecture
- Dual System Redundancy Architecture
  - Two(2) 3.5 Inch Hard Disk (RAID 1) / System
  - Two(2) Gigabit Ethernet Interface / System
- Dual Redundancy Power Module

# Hardware Specification

## IPNext3000 Call Manager

RISC  
CPU

- 64bit High-End Microprocessor Computing Power
- Main Chassis
  - Dual Redundancy CPU Boards for System Fault Tolerant
    - Two(2) 10/100Mbps Gigabit Ethernet
    - One(1) RS-232C Console (RJ45)
    - Two(2) 3.5 Inch Hard Disk Interface Slot (RAID 1)
  - Dual Redundancy Power Supply Module
  - Hot-Swap Features



# Hardware Specification

## IPNext3000 Call Manager

RISC  
CPU

### IPNext3000 Front Side

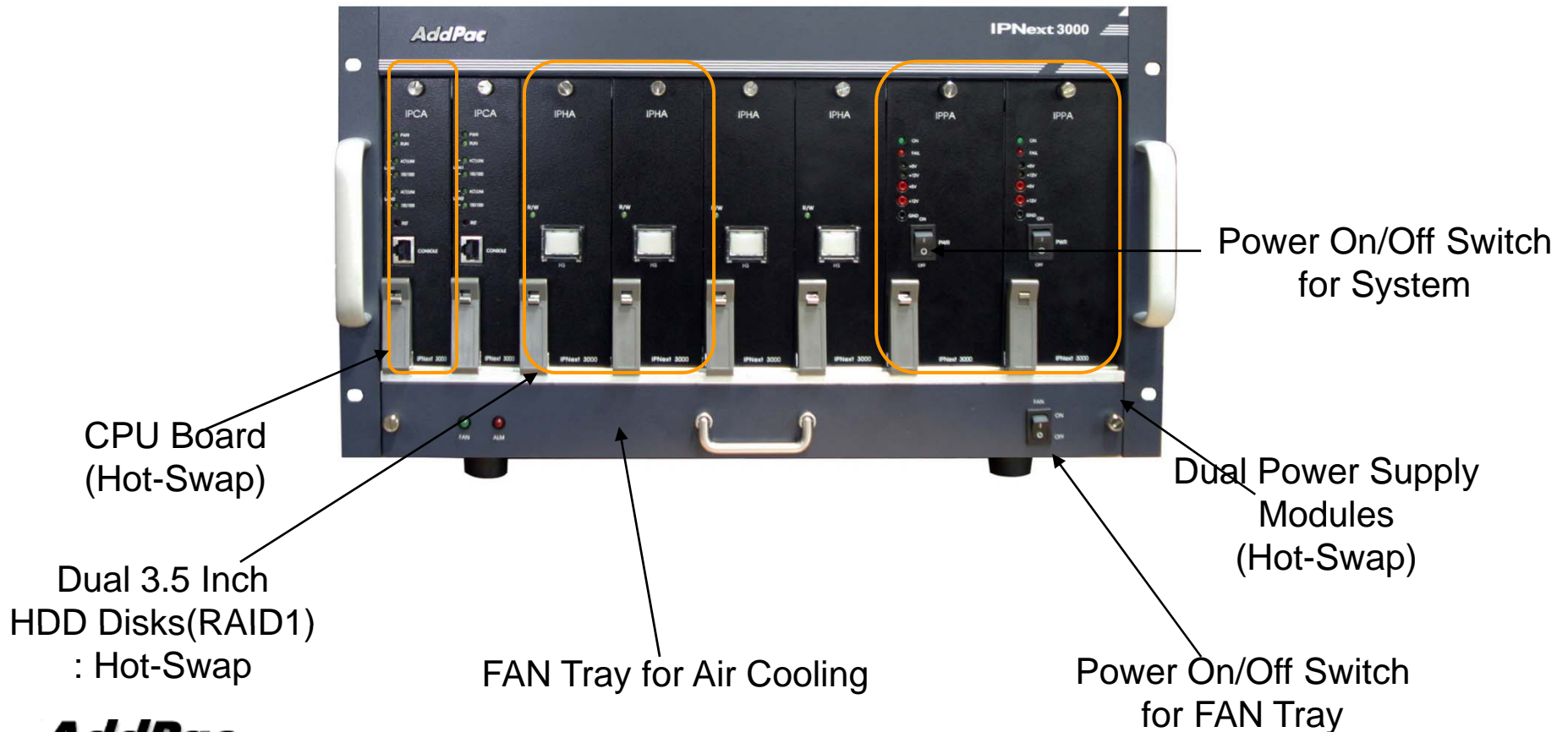

**AddPac**

[www.addpac.com](http://www.addpac.com)

# Hardware Specification

IPNext3000 Call Manager



## IPNext3000 Back Side

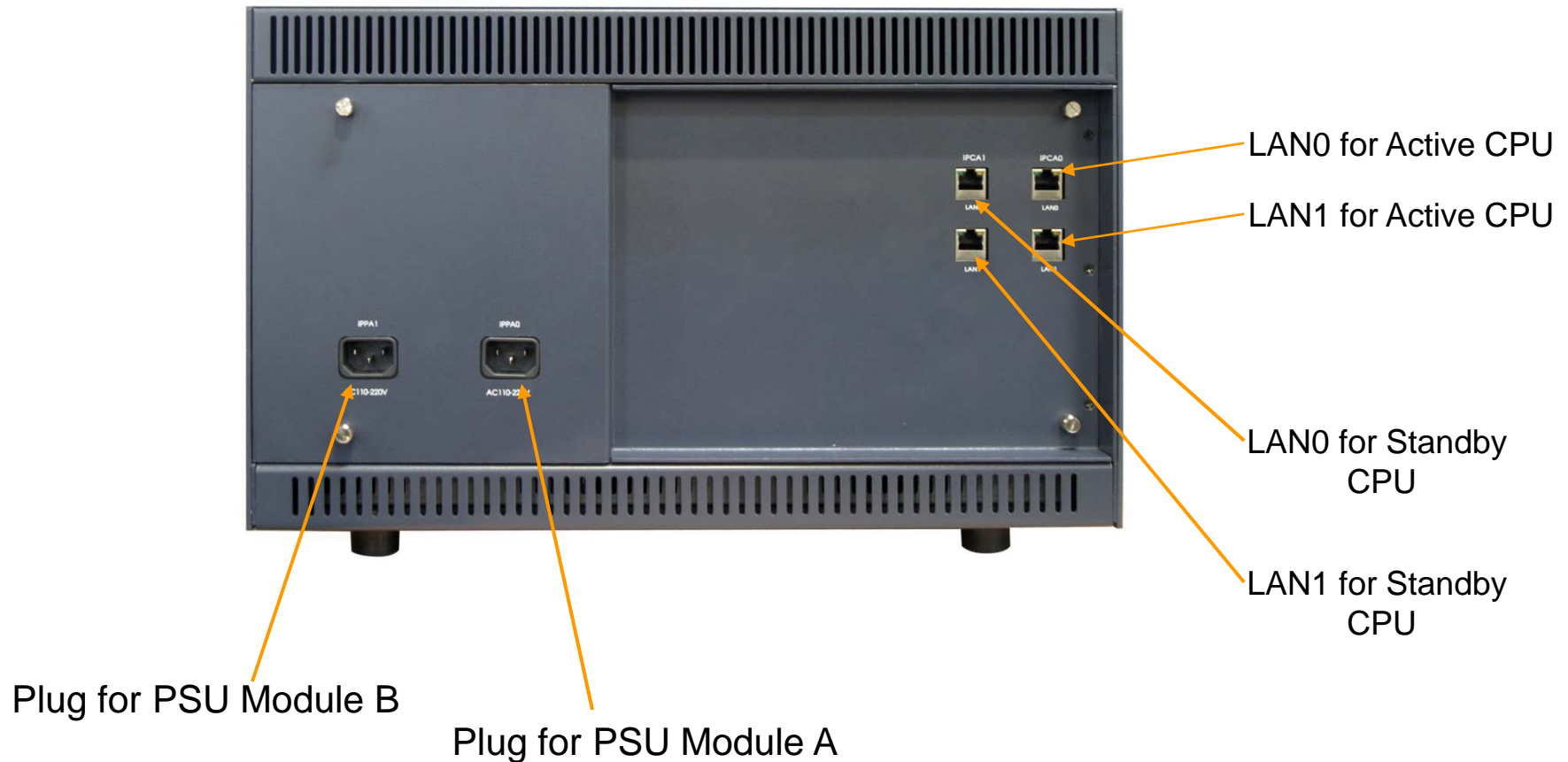

# System Redundancy Features

IPNext3000 Call Manager

IPNext3000 System Block Diagram

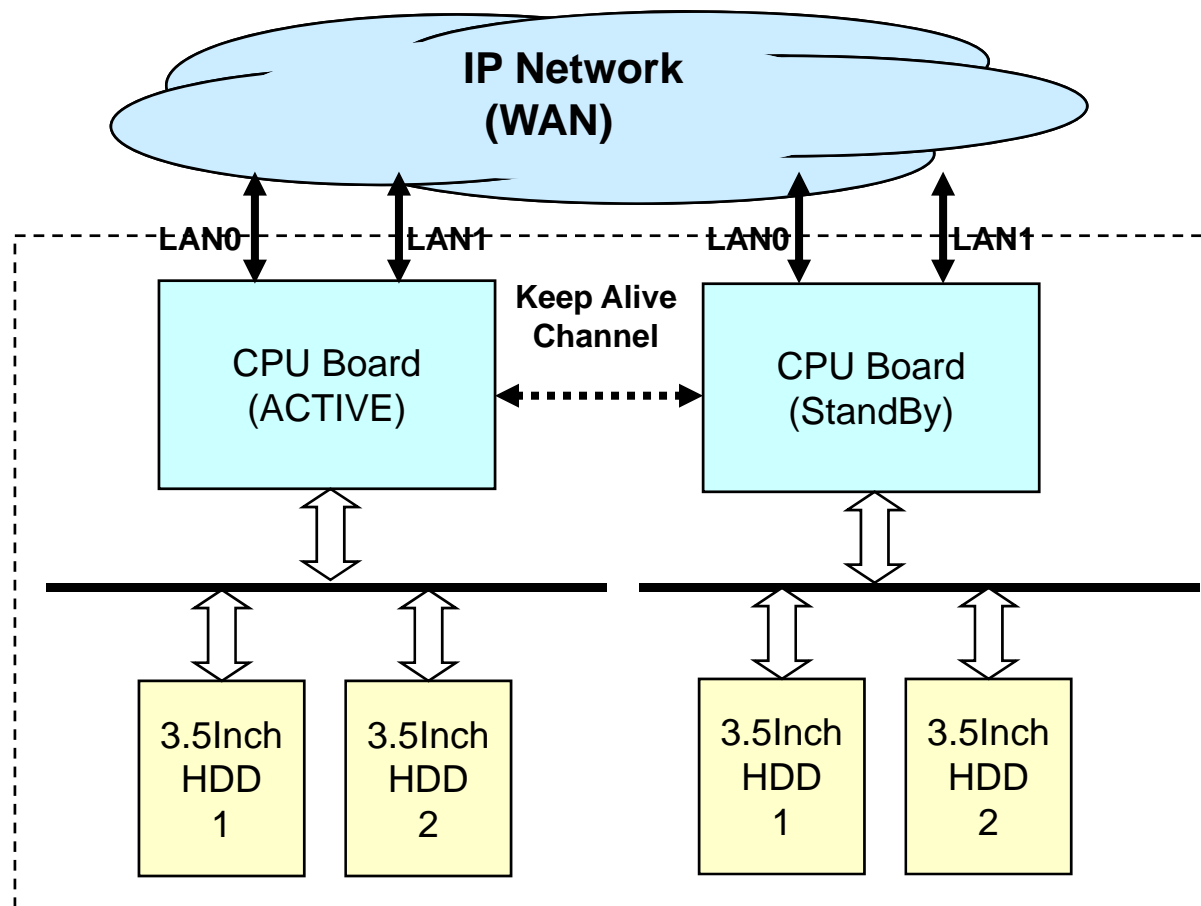



# System Redundancy Features

## IPNext3000 Call Manager

- Active– Active Duplication Scheme
- Active – Standby Duplication Scheme
- VRRP based Duplication Scheme

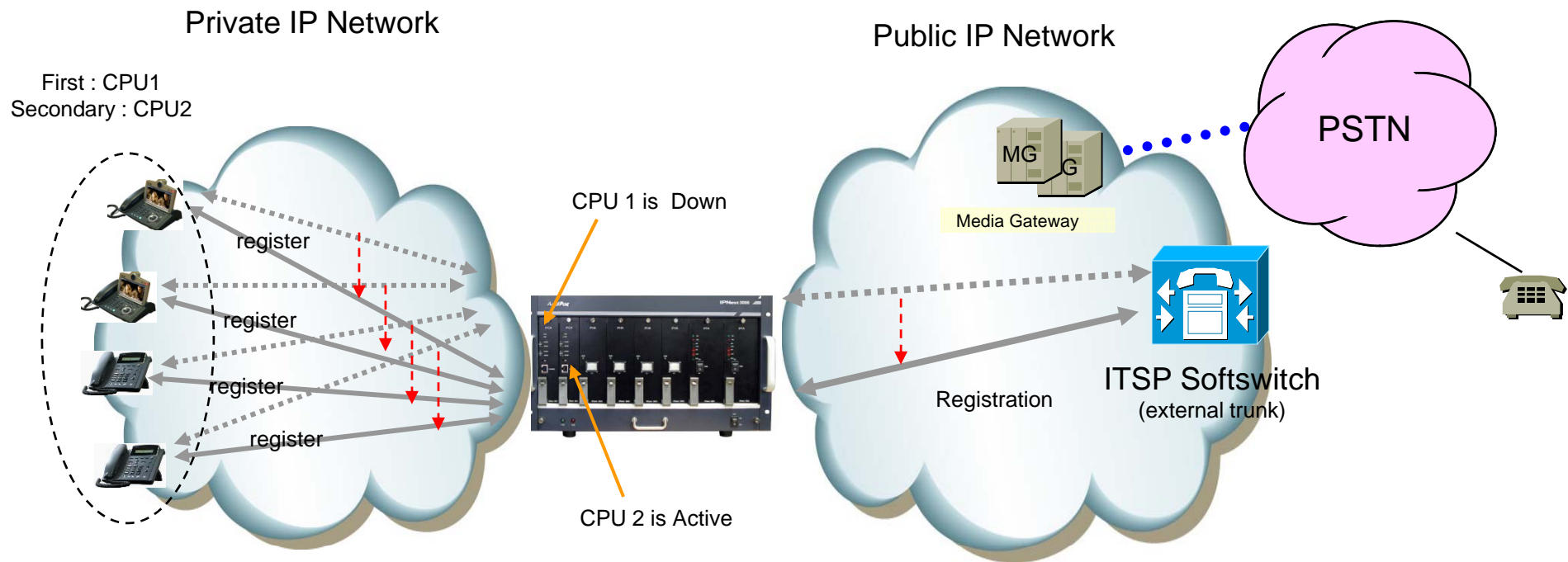

Active – Standby Duplication Scheme (example)

# AP-NR2000L IP Voice Recording Server

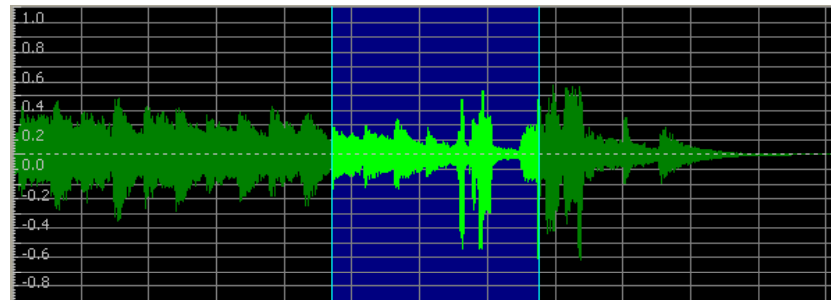

# Main Features

## AP-NR2000L IP Voice Recoding Server

- IP based Network Voice Recording Server
- Powerful Management and User Friendly Features
- Fault Tolerant and Scalability Architecture
- High-performance Voice Recoding Service
- External Voice Transcoder(ex:AP-VTC1000) Interworking Support
- Firmware Upgradeable Architecture
- Two(2) Gigabit Ethernet Interface
- Ten(10) 3.5Inch IDE type Hard Module Slot
- RAID 1 Hard Disk Backup
- Smart Digital Voice Recording Management Software

# Hardware Specification

## AP-NR2000L IP Voice Recoding Server

High-End  
RISC  
CPU

- RISC Microprocessor Computing Power
- Main Chassis
  - Network Interface
    - Two(2) 10/100/1000Mbps Gigabit Ethernet
    - One(1) RS-232C Console (RJ45)
  - Ten(10) Hard Disk Interface Slot for RAID1 Configuration

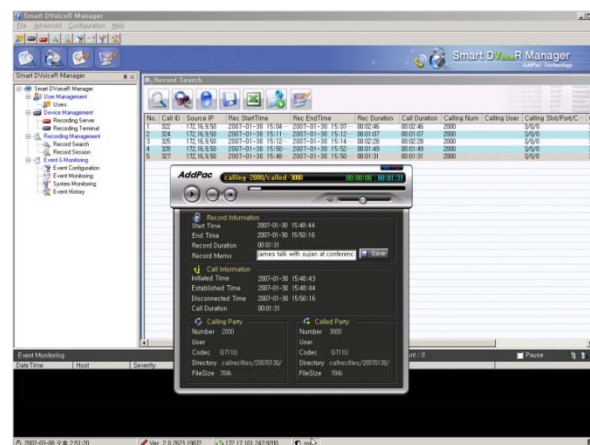

# Hardware Specification

AP-NR2000L IP Voice Recoding Server

High-End  
RISC  
CPU

## Front Side

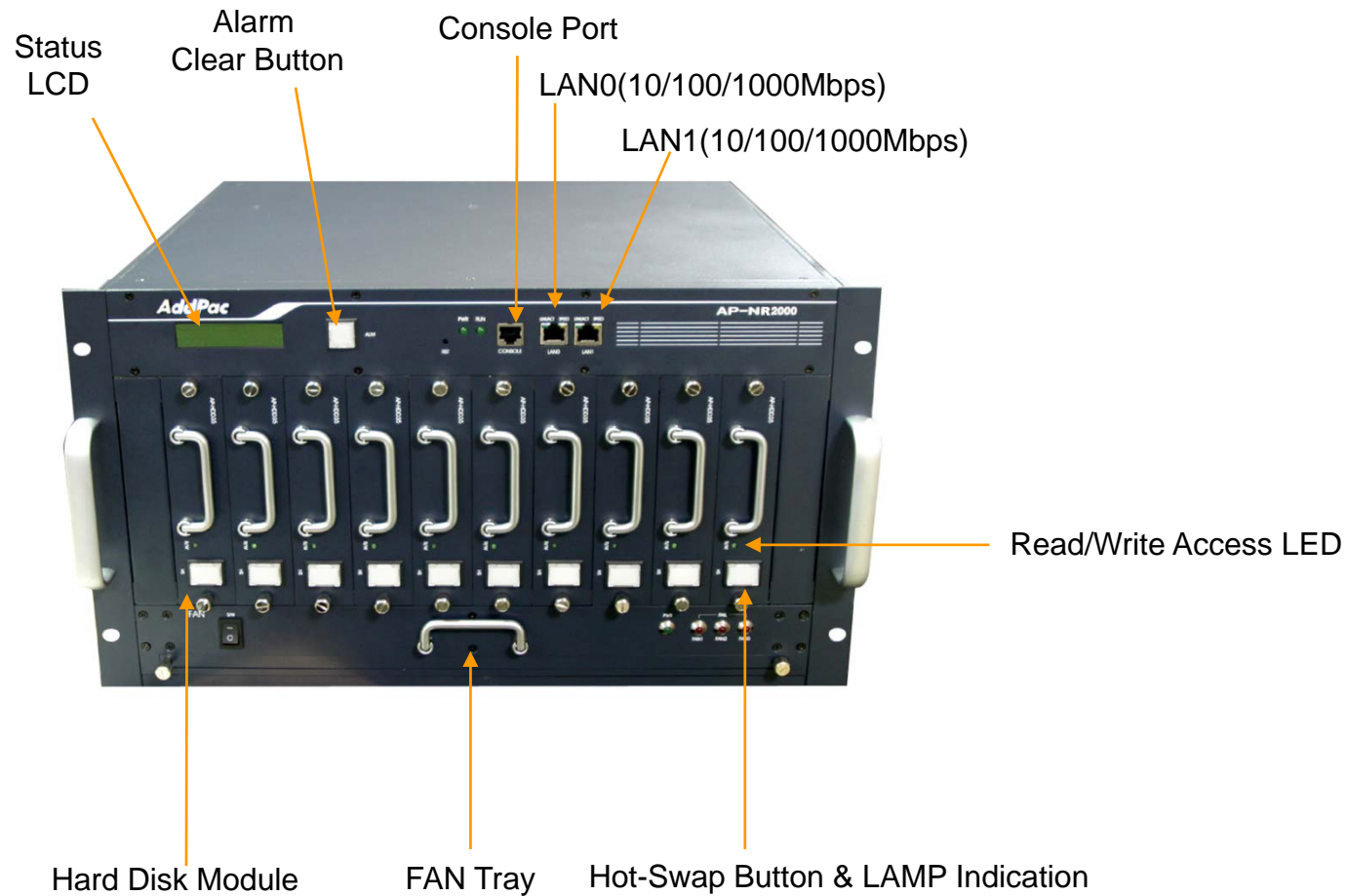

# Hardware Specification

AP-NR2000L IP Voice Recoding Server

High-End  
RISC  
CPU

## Back Side



Power Supply  
Module

Power ON/OFF  
Switch

Power Inlet

# Smart DVoiceR Management Program

AP-NR2000L IP Voice Recoding Server

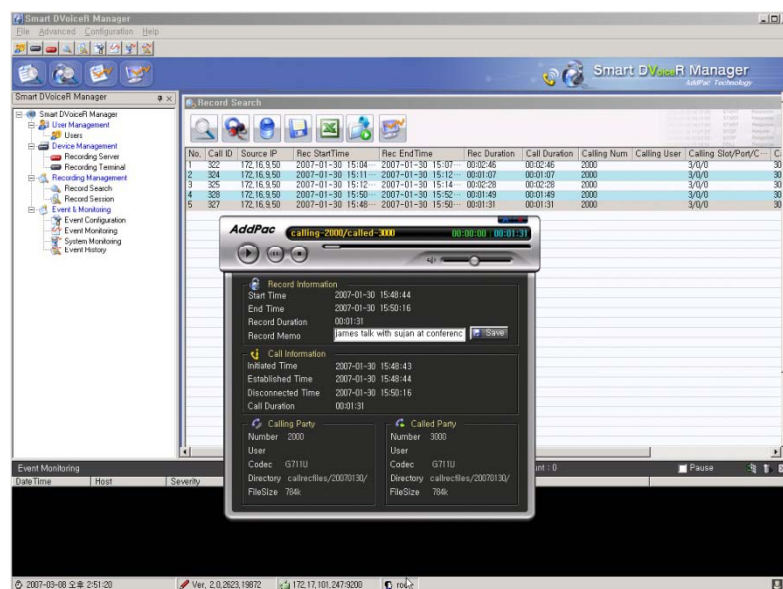

- Call History Management (search/modify/delete/save)
- Media Play Management (Play/Stop/Seek/Pause)
- Live Call List Management, Live Call Monitoring
- Local Backup (File Manager Support, PC HDD, DVD) and Local Play
- User Management (registration/modify/delete/search)
- Server Status (CPU/Memory/HDD) & Event Monitoring
- Waveform Analyzing Function
- Recording Source Management (VoIP Gateway, IP Phone, etc)
- Live Recording Board

# Network Service Diagram

## AP-NR2000L IP Voice Recoding Server

◆ Enterprise Application  
(Digital Interface)

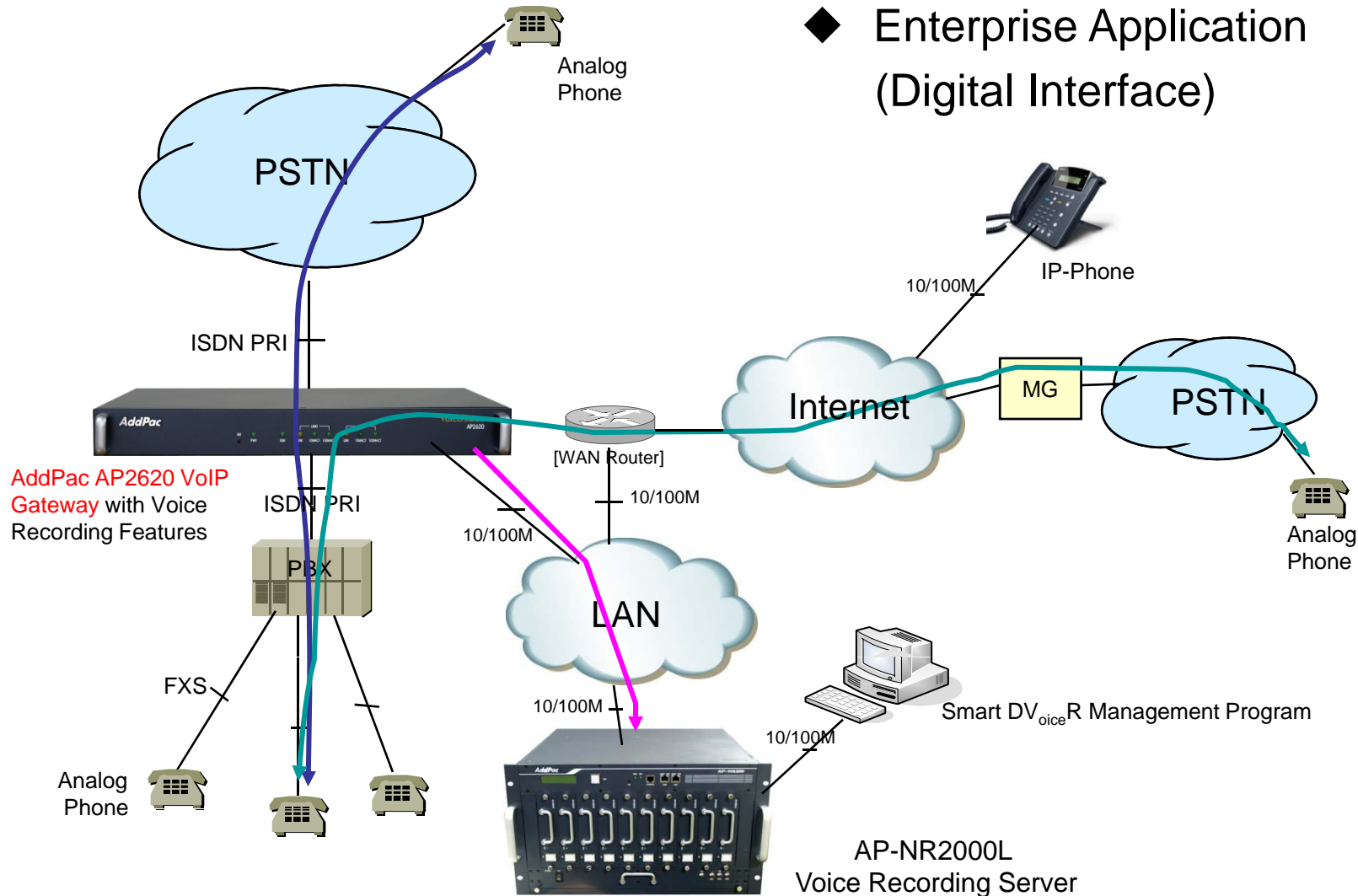





# AP-MC1500 Audio MCU

# Main Features

## AP-MC1500 Voice MCU

- IP based Hardware Audio Mixing Solution
- Two(2) DSP Module Slots for Audio Mixing
- 64Ch, 128ch Audio Mixing DSP Modules
- Compact PCI Style Hot-Swap Support
- Support Various Conference System Model
- Scalability and Flexibility
- High-performance Voice Mixing Service
- SIP and H.323 VoIP Signaling Support
- Various Voice Codec Support (G.711,G.729, G.723, etc)
- Two(2) 10/100Mbps Fast Ethernet Interface
- Firmware Upgradeable Architecture
- Audio Solution with Outstanding Network Service Capability

# Hardware Specification

AP-MC1500 Audio MCU

PowerPC  
CPU

High-end  
DSP

- High Performance RISC Microprocessor Computing Power
- Built-in High-end Programmable DSP Hardware Architecture
- Main Chassis
  - Network Interface
    - Two(2) 10/100Mbps Fast Ethernet
    - One(1) RS-232C Console (RJ45)



# Hardware Specification

AP-MC1500 Audio MCU

PowerPC  
CPU

High-end  
DSP



DSP Module

Hot-Swap Ejector

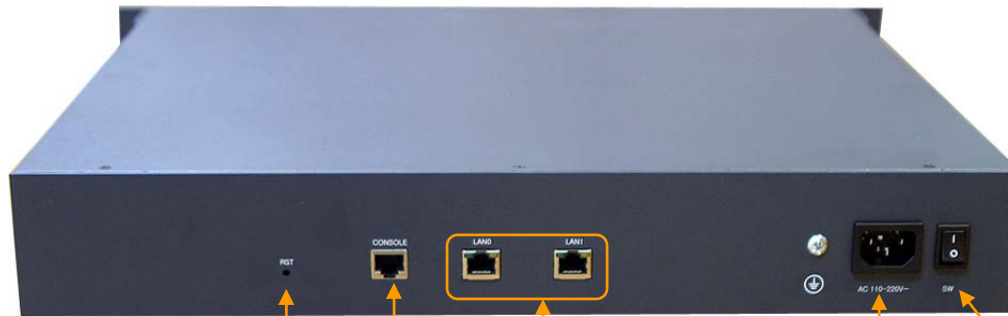

Reset

Console Port

Two(2)  
LAN Port

Power Inlet

Power Switch

# Hardware Specification

## AP-MC1500 Audio MCU

PowerPC  
CPU





High-end  
DSP

- MCU Module (HIM-AMCU128)
  - High quality Audio Mixing
  - 128Channel Audio Mixing
  - Compact PCI Style Hot-Swap Function
  - High-End Programmable DSPs
  - Parallel DSP Processing for High Quality Audio Mixing
  - Concurrent Different Audio Codec Support
- MCU Module (HIM-AMCU64)
  - High quality Audio Mixing
  - 64 Channel Audio Mixing
  - Compact PCI Style Hot-Swap Function
  - High-End Programmable DSPs
  - Parallel DSP Processing for High Quality Audio Mixing
  - Concurrent Different Audio Codec Support
  - Cascade Support

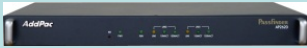

# AP2620 VoIP Gateway with Voice Recording Feature

# VoIP Gateways with Voice Recording Extension

Product	AP2620	AP2640	AP2650	AP-MG3000
				
Available Modules	AP-FXS4 AP-FXO4 AP-FXS2O2 AP-E&M4 AP-E1	AP-FXS8 AP-FXO8 AP-FXS4O4 AP-E&M8 AP-E1	AP-FXS8 AP-FXO8 AP-FXS4O4 AP-E&M8 AP-E1	APv2-1E1 APv2-2E1 APv2-4E1
Analog Ports	Up to 8	Up to 32	Up to 32	N/A
Signaling	SIP, H.323	SIP, H.323	SIP, H.323	SIP, H.323
Digital E1/T1	Up to 2E1/T1	Up to 2E1/T1	Up to 2E1/T1	Up to 4E1/T1
E&M	Support	Support	Support	N/A
Module Slot	Two(2)	Four(4)	Four(4)	Two(2)
LAN Port	2	2	2	2
Console	1	1	1	1
Power	Single PSU	Single PSU	Dual PSU	Single PSU

# Main Features

## AP2620 VoIP Gateway

- Voice Recording Interface Support
- FXS, FXO, E&M, Digital E1/T1 VoIP Interface
- Two(2) Module Slots for Analog/Digital VoIP Interface
- Up to 2E1/T1 Digital Interface
- Up to 8 Port Analog Interface
- IPv4/IPv6 Address Support
- SIP, H.323, MGCP VoIP Signaling Support
- Firmware Upgradeable Architecture
- Rack Mountable Chassis





# AP-IP300 IP Phone



# Main Features

## AP-IP300 IP Phone

- 4.3 Inch Color LCD Display
- External I/O Interface
  - Audio In/Out
  - Two(2) Fast Ethernet Interface
  - PSTN FXO Interface (optional)
- PoE (Power over Ethernet) Support
- 25 Speed Dial button with Presence Indication Lamp
- Audio Broadcasting Controller & Terminal
- Providing Powerful Push-to-Talk Service
- Powerful Color GUI
- IPv4/IPv6 Address Support
- SIP, H.323 Signaling Support
- High-end Error Resilient Against Various Packet Error

# Hardware Specification

## AP-IP300 IP Phone

- RISC+DSP Microprocessor Computing Power (Dual Processor Architecture)
- High Quality 4.3 Inch Color LCD Panel
- 25 Speed Dial Key & User Presence Indication LED
- Optional PSTN Backup Interface
  - FXO Interface
- High quality Audio and Voice Interface
  - Stereo Audio Input Connector
  - Stereo Audio Output Connector
- Network Interface
  - Two(2) 10/100Mbps Fast Ethernet
- USB Host Mode Interface
  - USB Memory(Flash, HDD), etc
- Power Supply
  - Power over Ethernet
  - External Power Adaptor (5V, 3A)



# Hardware Specification



AP-IP300 IP Phone





# AP-PT50 Extend Key Box

# IP Extend Key Pack Comparison Table

Model	AP-PT100	AP-PT50	AP-PT20
Service Features			
Key Type	7 inch LCD Touch Screen	Push Button with User Presence Indication LAMP	Push Button with User Presence Indication LAMP
Key Number	Default : 9(row) x 4(column) = 36	60 Key	40 Key
User Presence Indication	Support	LED on, LED off, LED Blink	LED on, LED off, LED Blink
Multiple Cascading	Support	Support	Support
Speaker	Support	Support	Support
LAN Port	2	2	2
PoE(Optional)	Support	Support	Support
Application	IP Phone or Video Phone Extend Key Pack	IP Phone or Video Phone Extend Key Pack	IP Phone or Video Phone Extend Key Pack

# Main Features

## AP-PT50 IP Extend Key Pack

- Speed Dialing Terminal with User Presence Indication LAMP
- 60 (3 Column x 20 Row) Speed-Dial Key Buttons
- Inter-working with IP Terminal, Presence Server, Call Manager
- Multiple Terminal Cascading Feature
- User Presence Indication LED (on, off, blink)
- User Presence Group Feature
- Firmware Upgradeable Architecture
- PoE (Power over Ethernet) Function

# Hardware Specification

AP-PT50 IP Extend Key Pack

RISC  
CPU

- RISC+DSP Microprocessor Computing Power
- 60 Speed Dial Key with User Presence LAMP
- Optional PoE (Power over Ethernet) Interface
- Network Interface
  - Two(2) 10/100Mbps Fast Ethernet
- Power Supply
  - Power over Ethernet (Option)
  - External Power Adaptor (5V, 2A)
  - Power Switch
- Connector for Cascading





# Hardware Specification

AP-PT50 IP Extend Key Pack

RISC  
CPU

## Front Side

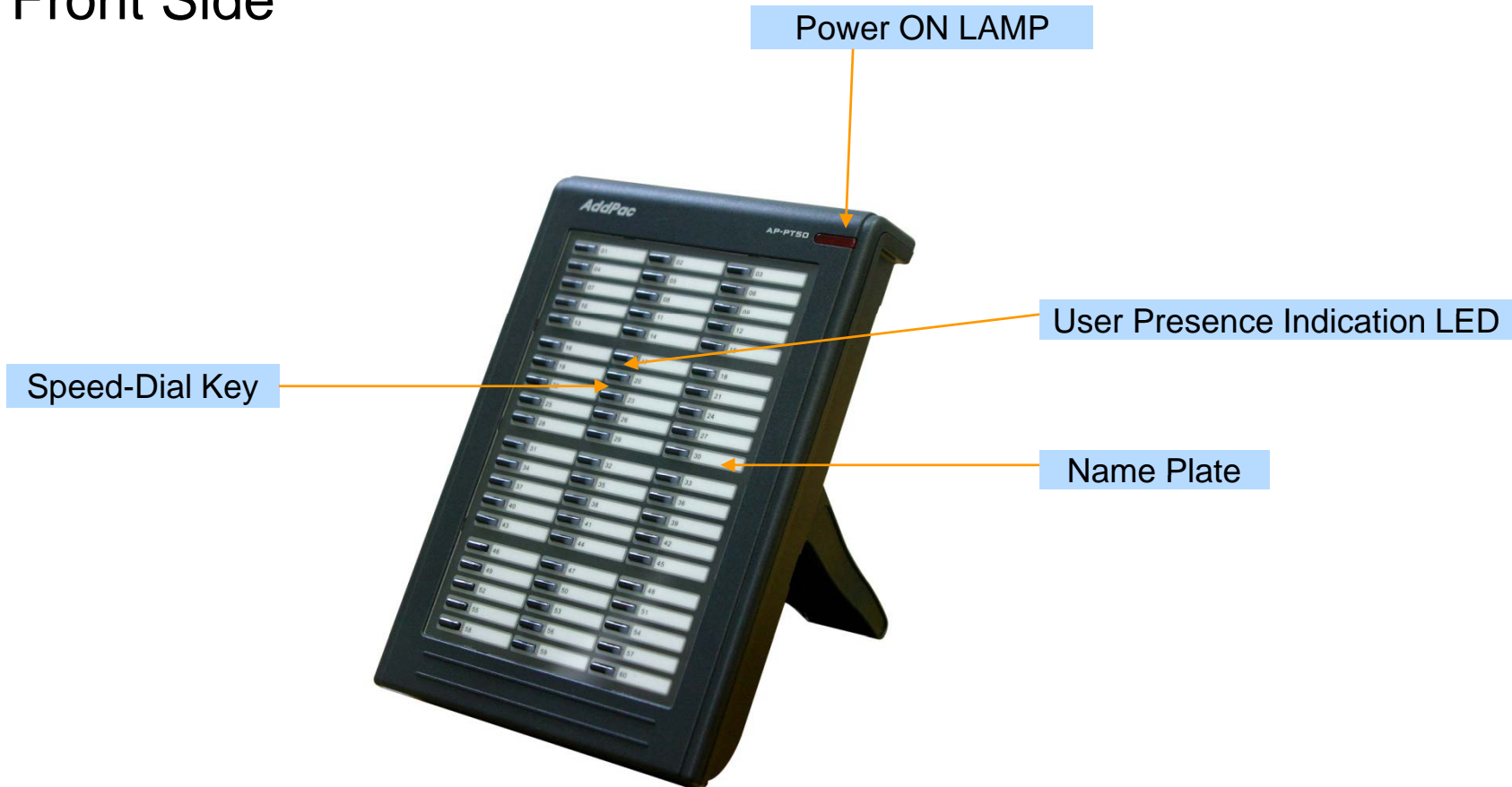



# Hardware Specification

AP-PT50 IP Extend Key Pack

RISC  
CPU

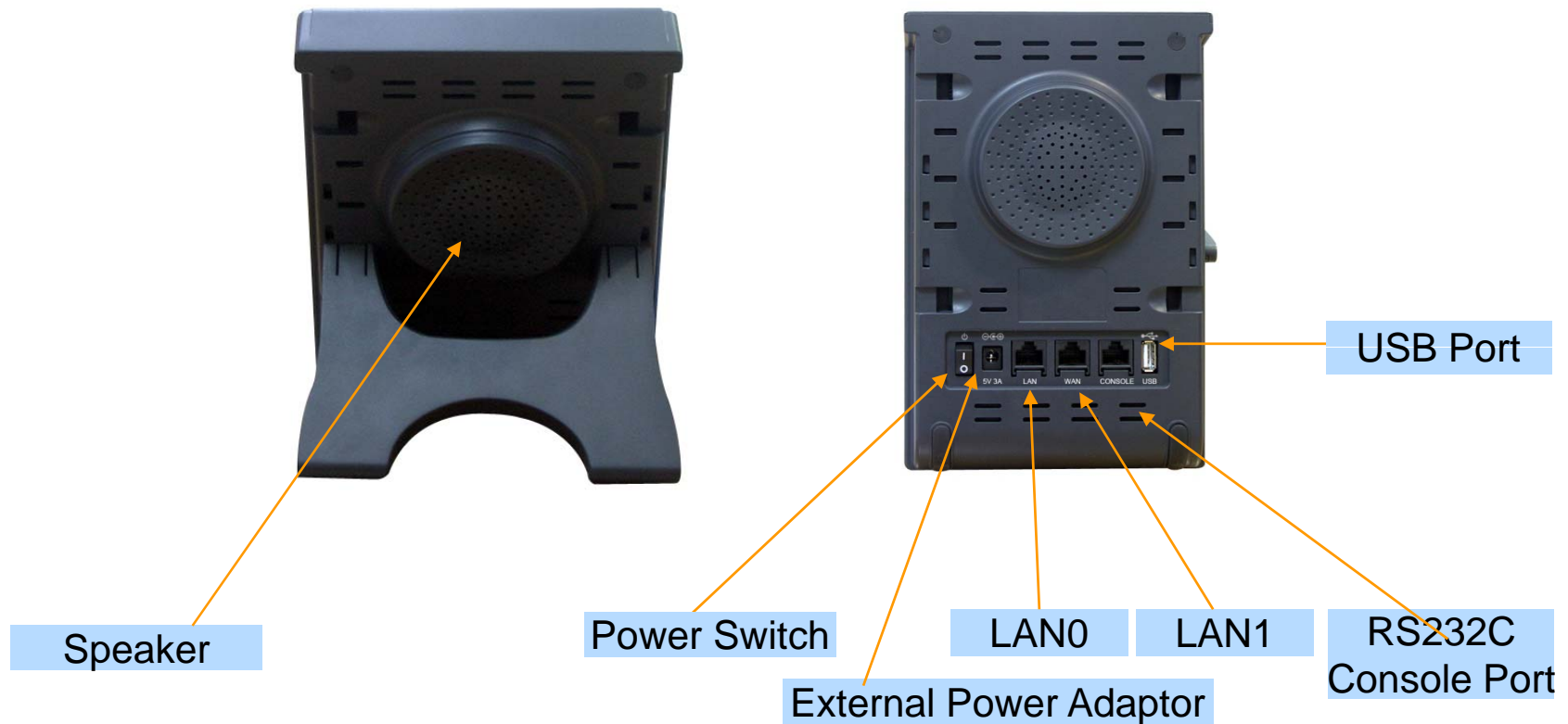
## Back Side





# AP-SAC Smart Attendant Console (Touch Screen Version)

# Contents

- Overview
- Touch Screen based Attendant Console System Diagram
- Touch Screen based Attendant Console Feature
- Touch Screen based Attendant Console UI
  - Login Feature
  - Main Screen Feature

# Overview

## Support Efficiently Call Routing and Smart Presence Service

- Touch Screen based Attendant Console Function
  - Support Call Routing Service
  - Support User Presence Information
  - Support Phone Number Presence Information
  - Support Attendant Phone Call Control
  - Support Call Status Display
  - Support Group Call(Conference)
  - Support Various Monitoring Group

# Touch Screen based Attendant Console System Diagram

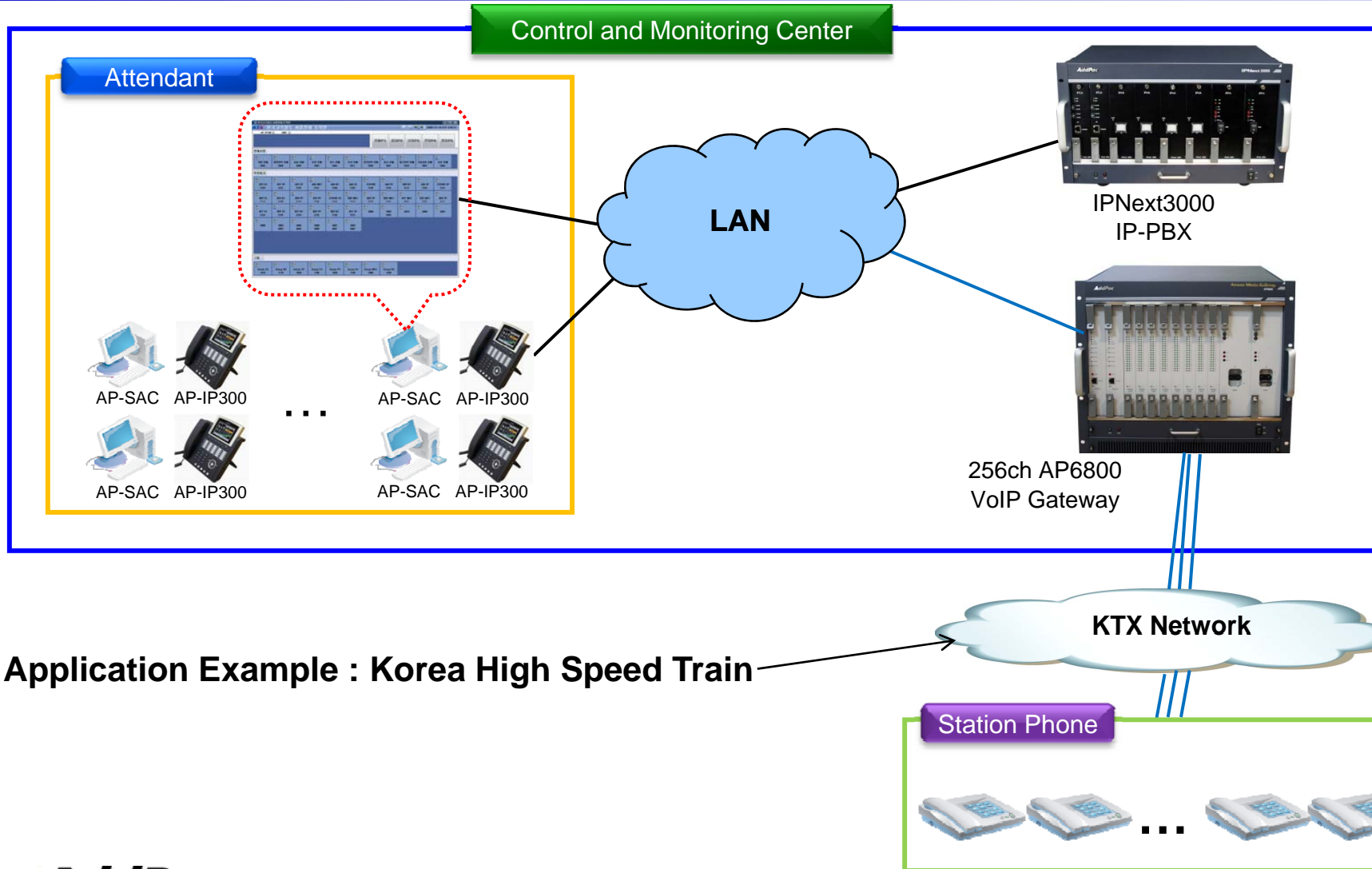

Application Example : Korea High Speed Train

# Touch Screen based Attendant Console Feature

- User Login Service
  - User Login and Logout Feature
- Monitoring and Group Management Service
  - Support Various Group
    - Attendant and Direct Phone Group
    - Office Phone Group
    - Conference Call Group
  - Support Group Management Feature
    - Add Group, Rename Group, Delete Group
    - Add User, Delete User
    - Add Conference Room, Delete Conference Room

# Touch Screen based Attendant Console Feature

- Monitoring and Group Management Service
  - Presence Feature
    - Phone Presence Status
      - Online, Working, Away, Absence
      - Be In Conference, Call Busy
    - User Presence Status
      - PC Online, Phone Online, PC-Phone Online
      - Working, Away, Absence
      - Be In Conference, Call Busy
    - Display Call Status
      - Display Call Status Icon for Talking Time
  - Call Control Feature
    - Interoperate with Monitoring Phone Information
    - Manual Call Dial
    - Drag and Drop Call Transfer and Manual Call Transfer



# Touch Screen based Attendant Console Feature

- Attendant Phone Call Control Service
  - Display Phone Call Status
    - Display Call Status Icon for Call Stat
    - Display Talking Call Status Icon for Talking Time
    - Support Multi-Call
  - Phone Call Control Feature
    - Dial to Monitoring Phone and Conference
    - Incoming Call Answer
    - Active Call Hold and UnHold
    - Call Transfer
    - Call Disconnect
    - Interoperate with Monitoring Phone Information
      - Drag and Drop Call Transfer and Manual Call Transfer

# Touch Screen based Attendant Console User Login

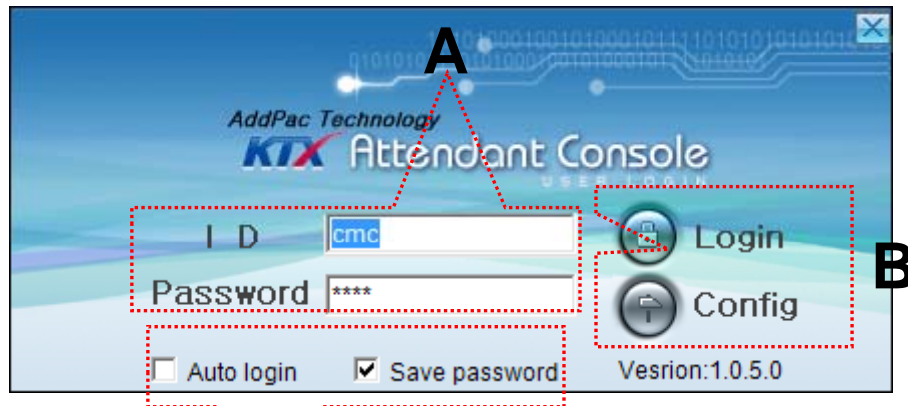

[Figure 1]

C

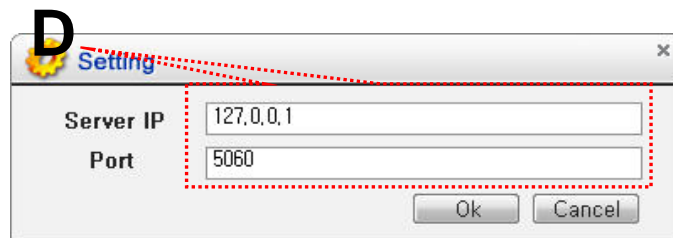

[Figure 2]



[Figure 3]

- Attendant Console Login
  - [Figure 1] shows the login picture of KTX Attendant Console program. “E” of [Figure3] is Icon of KTX Attendant Console Program.
  - When program is started initially, user should set the network configuration parameter such as IP address, Port number of Presence Server.[Figure2]
  - After inputting ID and Password, press the login button

# Touch Screen based Attendant Console Main Screen –Call Control

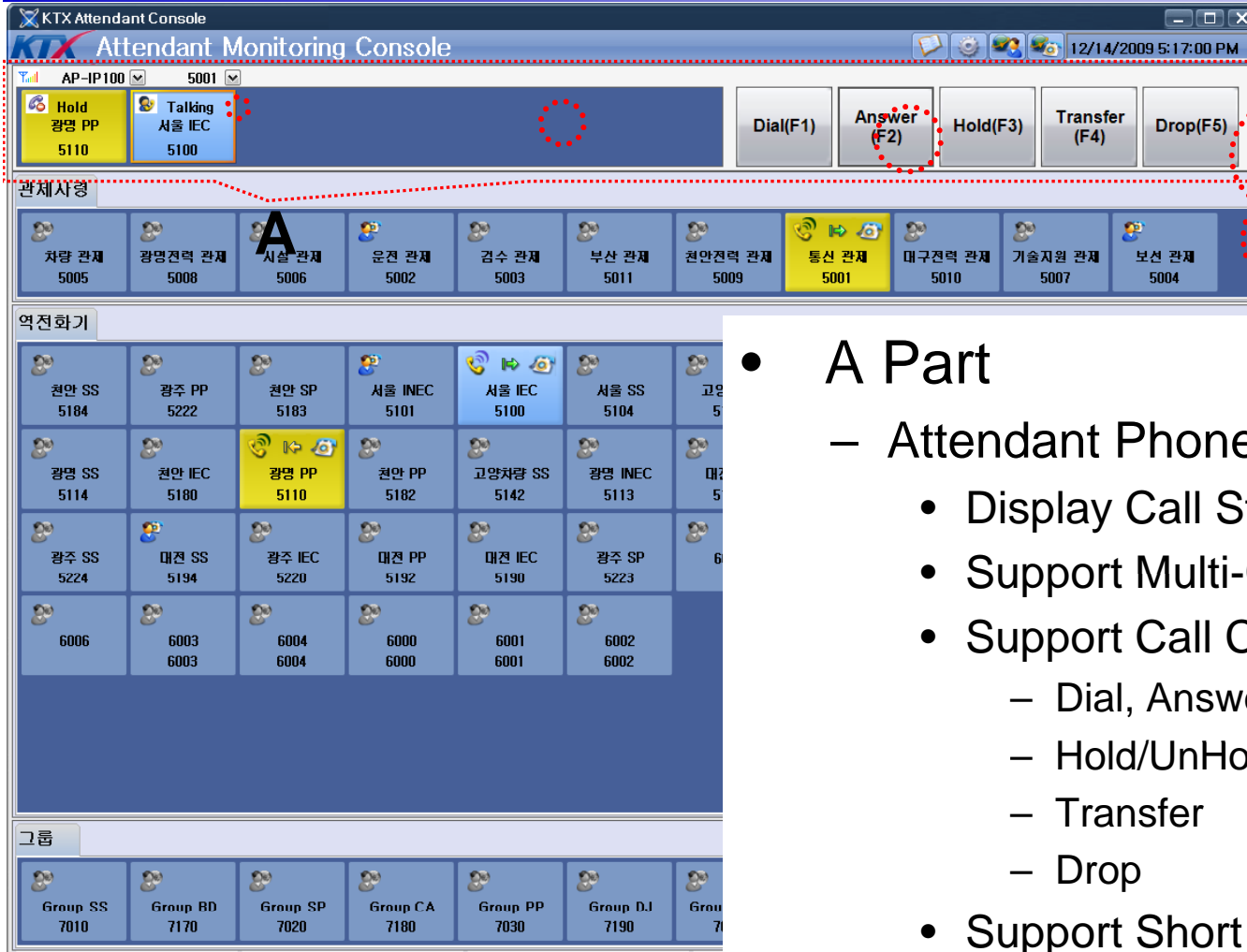

- A Part
  - Attendant Phone Call Control Part
    - Display Call Status
    - Support Multi-Call Display
    - Support Call Control Feature
      - Dial, Answer
      - Hold/UnHold
      - Transfer
      - Drop
  - Support Short Key Call Control

# Touch Screen based Attendant Console Main Screen –Monitoring



## • B Part

### – Monitoring Group Part

- Support Various Group
  - Attendant and Direct Phone Group
  - Office Phone Group
- Support Group Management Feature
  - Add Group, Rename Group, Delete Group
  - Add User, Delete User
- Provide Various User Presence Status
  - » PC Online, PC-Phone Online, Phone Online
  - » Offline, Away, Absence
  - » Be in Conference, Call Busy
- Display Call Status



# Touch Screen based Attendant Console Main Screen –Monitoring Group

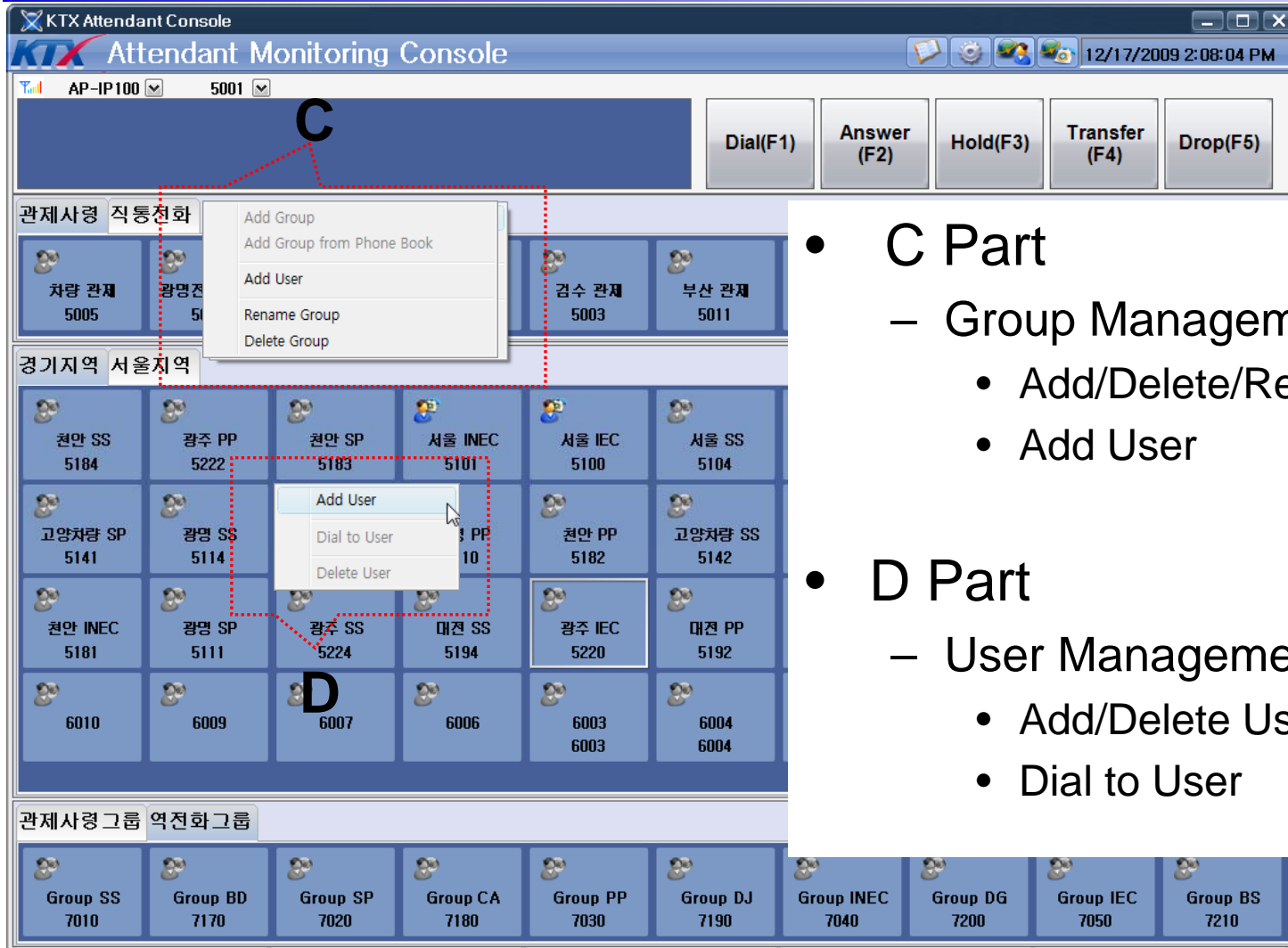

- C Part
  - Group Management Feature
    - Add/Delete/Rename Group
    - Add User
  
- D Part
  - User Management Feature
    - Add/Delete User
    - Dial to User

# Touch Screen based Attendant Console Main Screen – Group Call

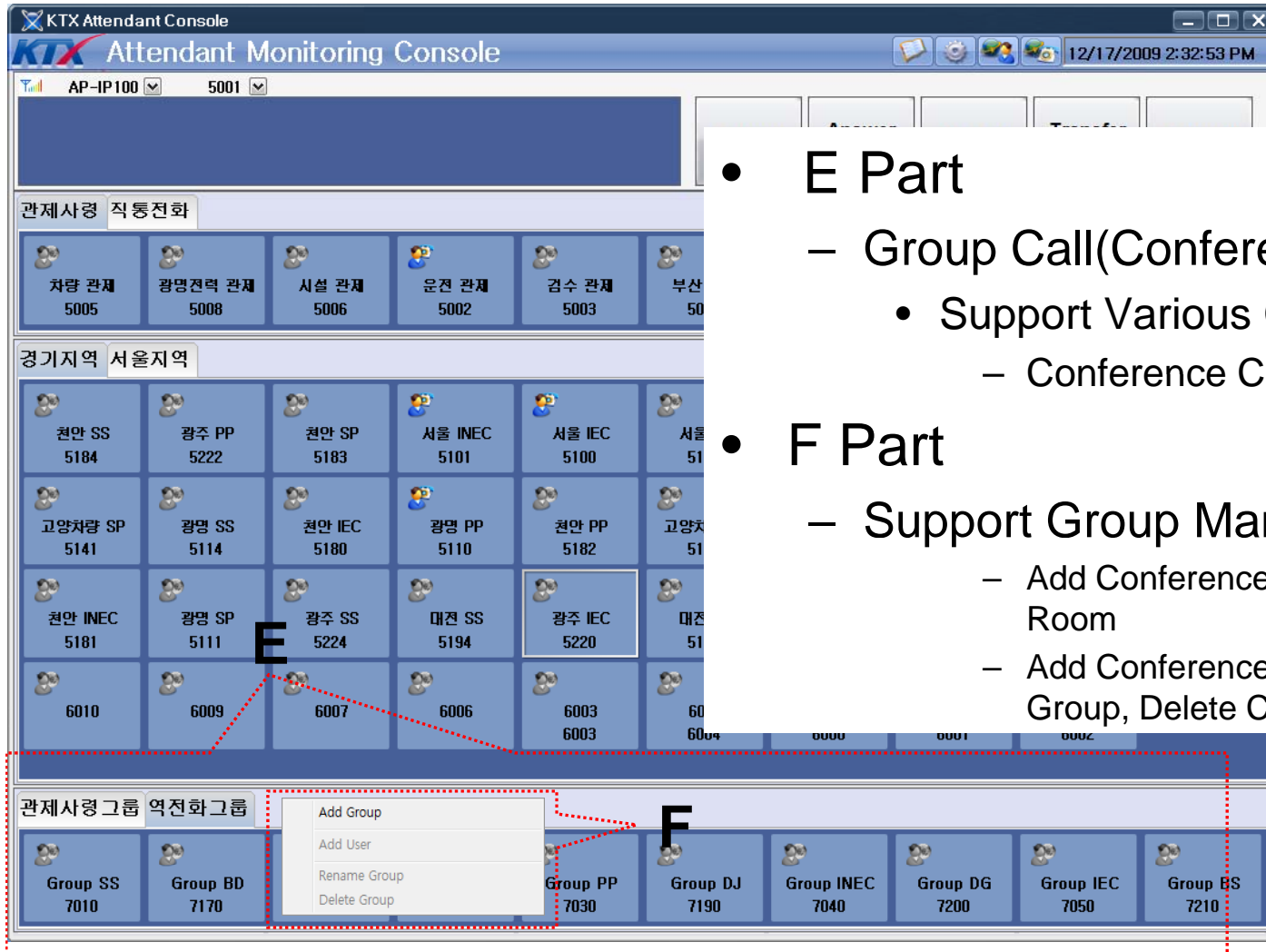

- E Part
  - Group Call(Conference) Part
    - Support Various Group
      - Conference Call Group
- F Part
  - Support Group Management Feature
    - Add Conference Room, Delete Conference Room
    - Add Conference Group, Rename Conference Group, Delete Conference Group



# Smart NMS

Smart Network Management System

# Main Features

- Web-based Management
- Network Resource Management
- Device Fault Management
- Device Fault History Management
- Device Status Information
- Notification Management
- Fault Statistics
- Model & Service Management

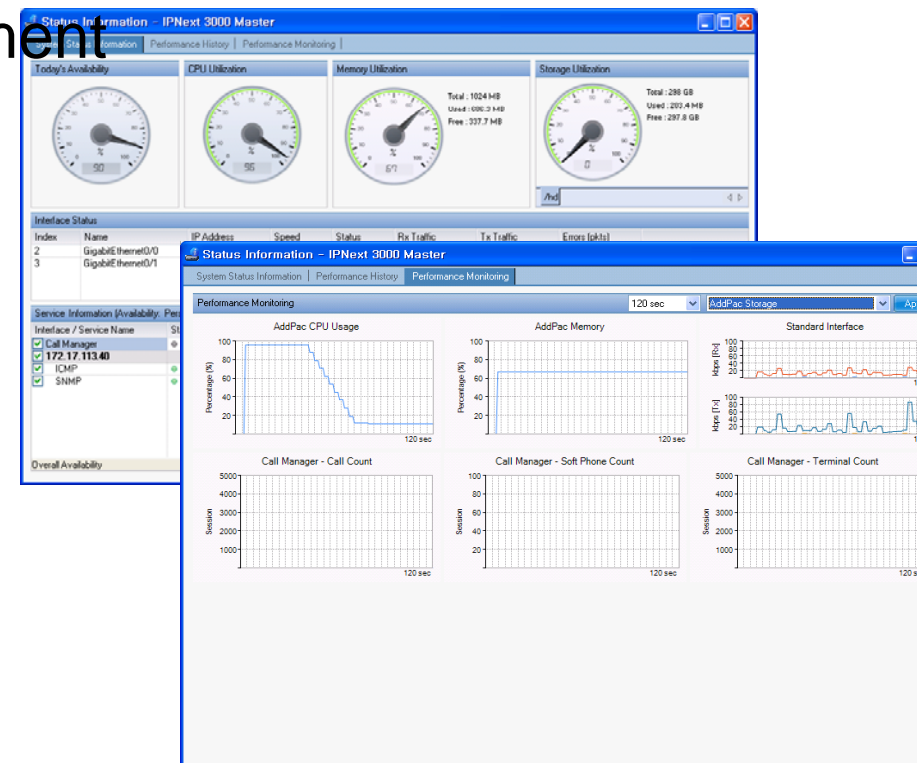





# Thank you!

AddPac Technology Co., Ltd.  
Sales and Marketing

Phone +82.2.568.3848 (KOREA)

FAX +82.2.568.3847 (KOREA)

E-mail [sales@addpac.com](mailto:sales@addpac.com)