

# AP-VAC50

## IP Video Door Phone

High Performance IP Video Door Phone Solution

WiFi Application for Wireless  
Network Configuration



***AddPac***

**AddPac Technology**

Sales and Marketing

# Contents

- Normal Wired Network Configuration Diagram
- Wireless Network Configuration using WiFi Access Point
- Multi-Attendant SIP based Call Model (Example)



AP-VP280  
IP Video Phone



AP-VAC50  
IP Video Door Phone



AP-ACS1000  
(SIP Call Manager + Door Access Control)

# Normal Wired Network Configuration

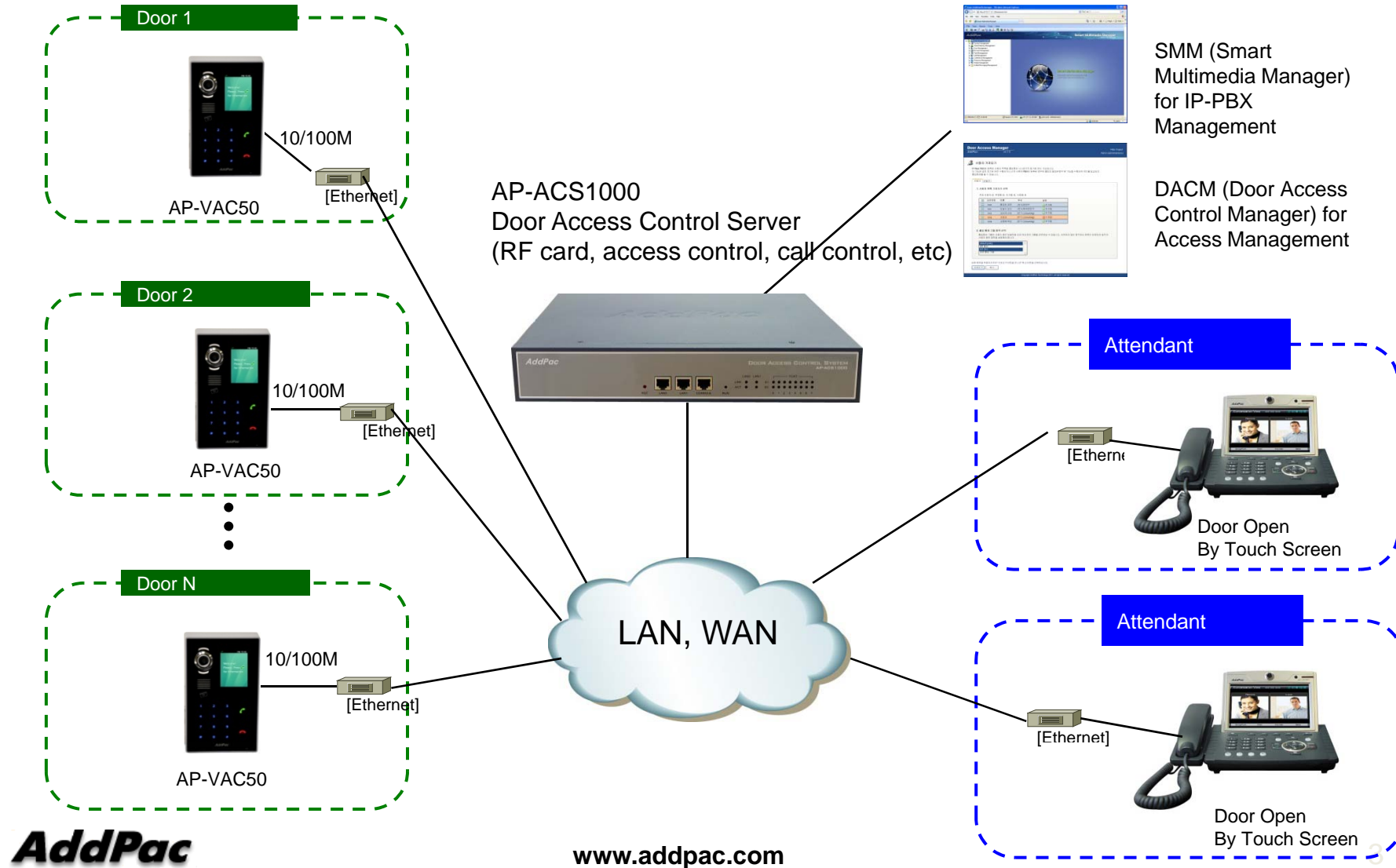

# Normal Wired Network Configuration

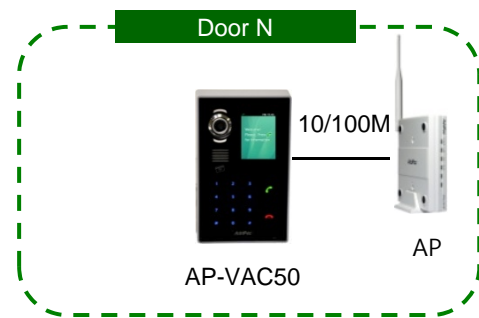
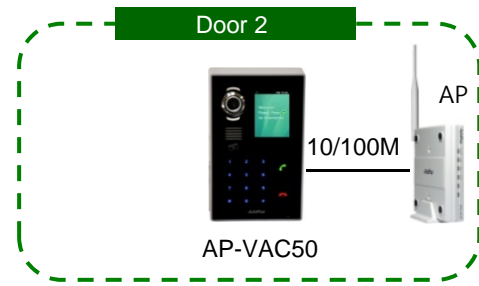
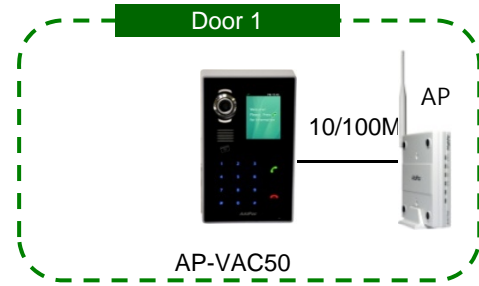

AP-ACS1000  
Door Access Control Server  
(RF card, access control, call control, etc)



SMM (Smart Multimedia Manager) for IP-PBX Management

DACM (Door Access Control Manager) for Access Management

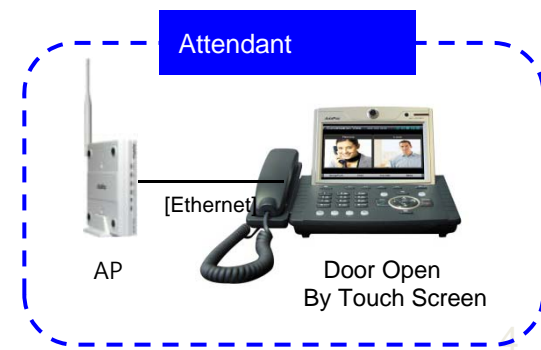
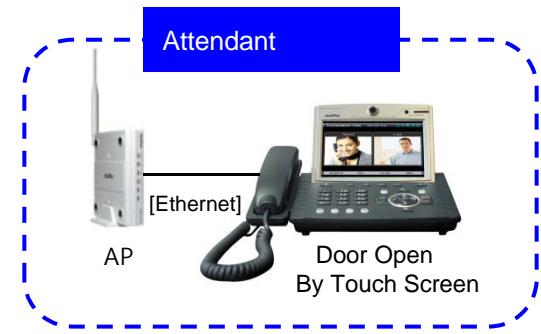

# Normal Multi-Attendant SIP Call Model Signaling Flow

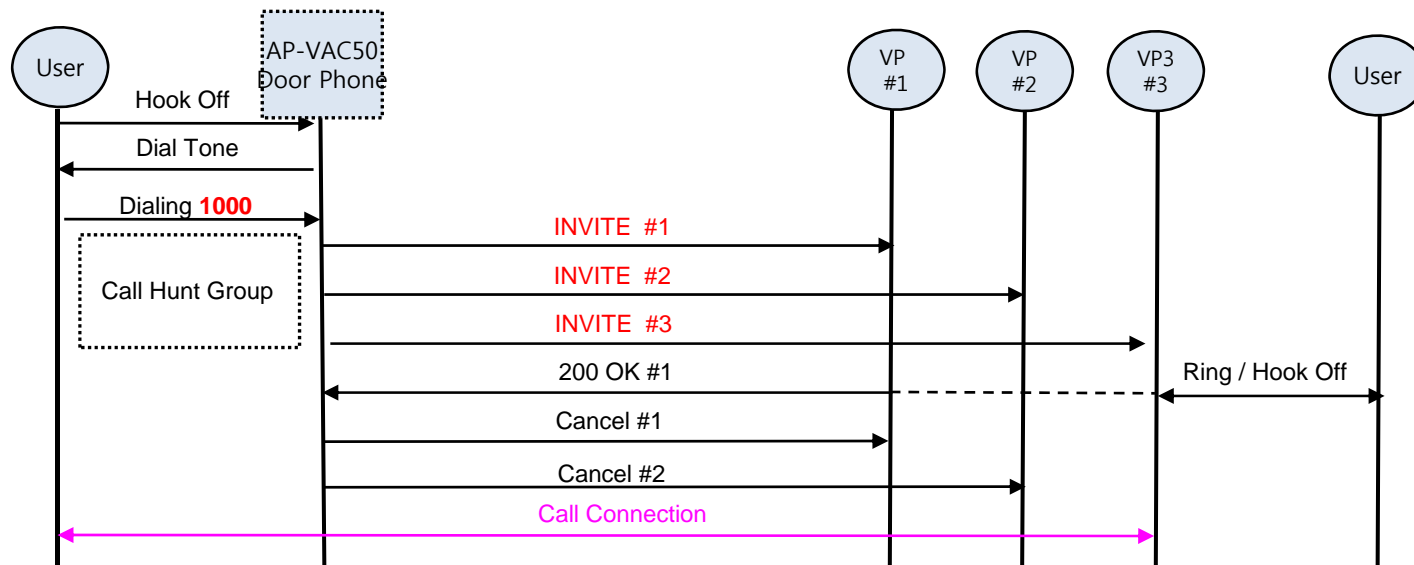
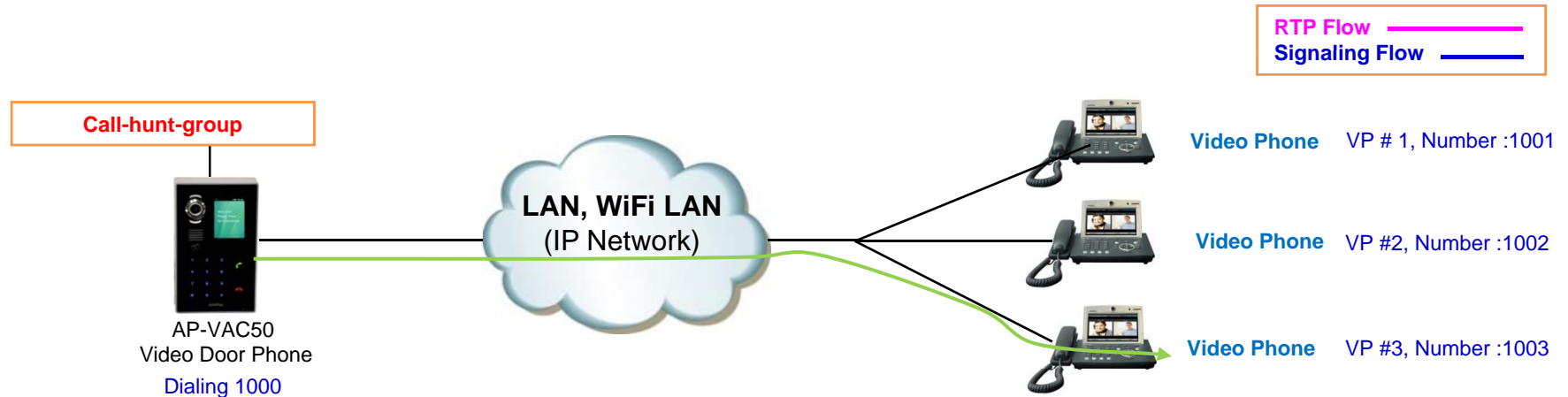



# Thank you!

**AddPac Technology Co., Ltd.**  
Sales and Marketing

Phone +82.2.568.3848 (KOREA)

FAX +82.2.568.3847 (KOREA)

E-mail [sales@addpac.com](mailto:sales@addpac.com)