

AP-VAC50

IP Video Door Phone

High Performance IP Video Door Phone Solution

Interworking with Smart Communicator
(AddPac Soft Video Phone)



AP-VAC50



AP-SMP100 Smart Communicator

AddPac

AddPac Technology

Sales and Marketing

Contents

- Network Diagram
 - Integrated Door Access Control and Call Control
 - Legacy PBX Environment
 - Legacy IP-PBX Environment
 - Interworking with Smart Communicator
- DACS System Message Flow
 - Registration and Keep Alive
 - Access Privilege and Schedule Download
 - RF Card Read/Write and Registration
 - Door Open by RF Card or Password
 - Door Open by AP-SMP100 Smart Communicator



Network Diagram

Integrated Door Access Control and Call Control

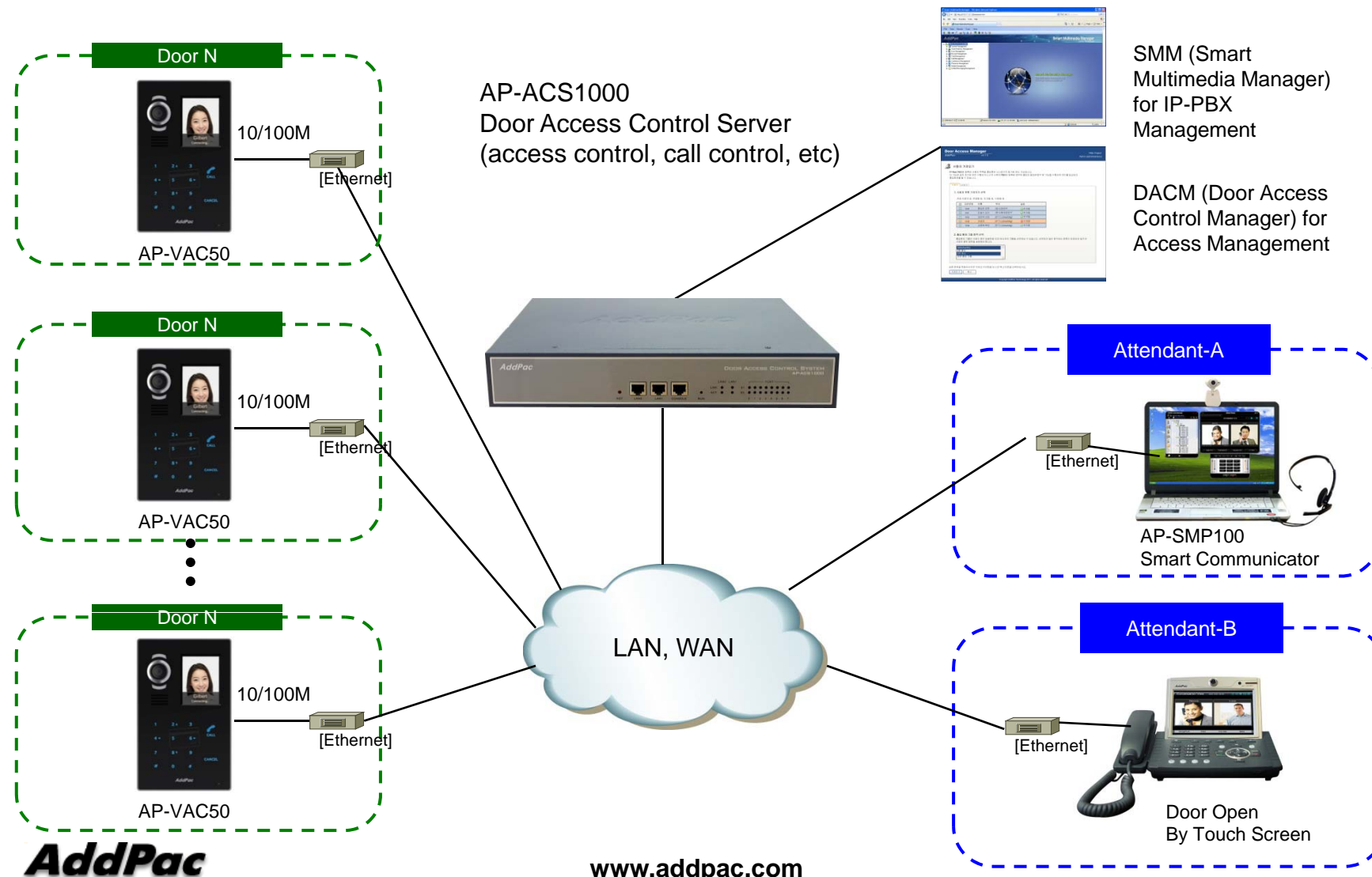

Network Diagram

Legacy PBX Environment

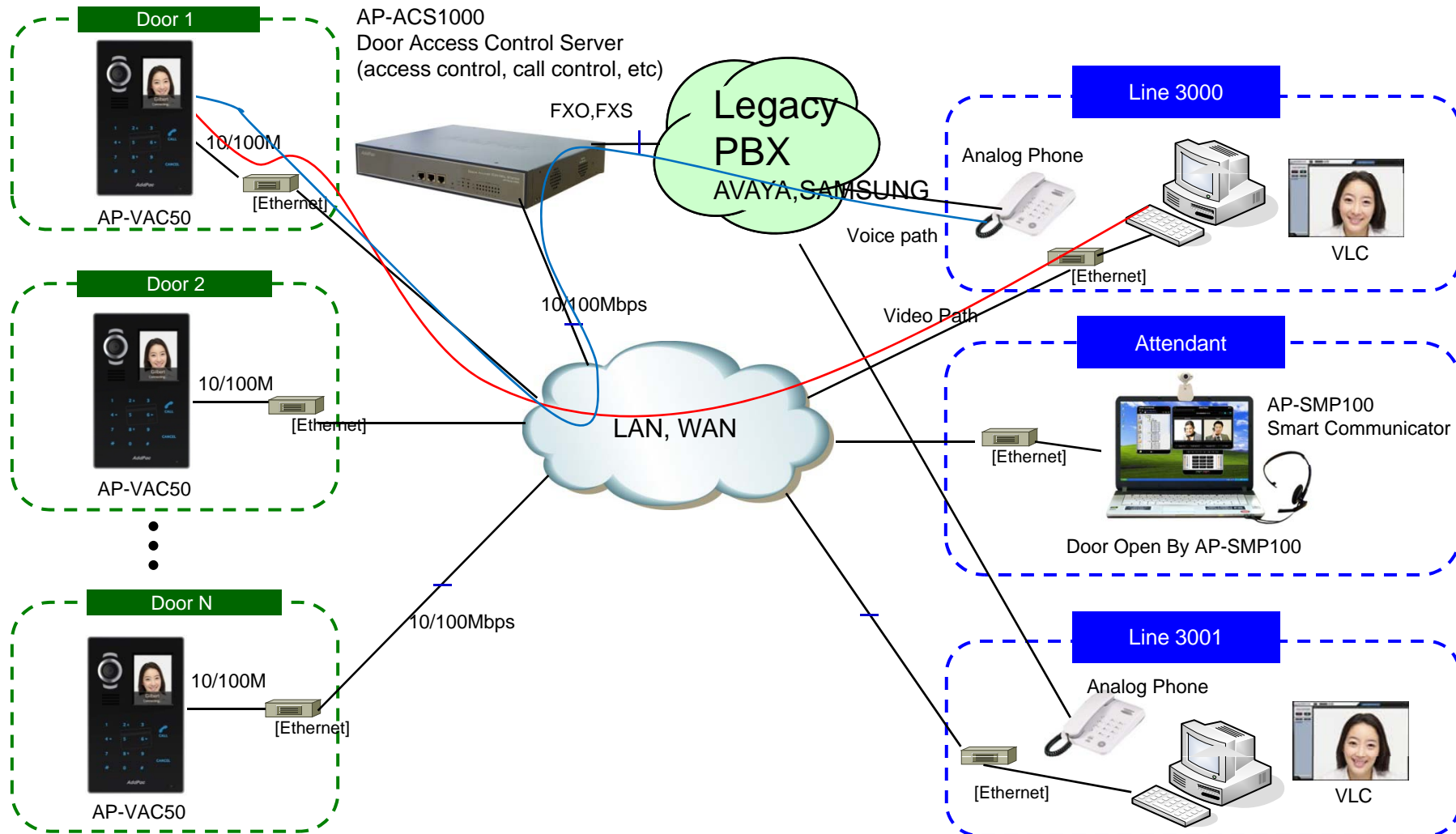

Network Diagram

Legacy IP-PBX Environment

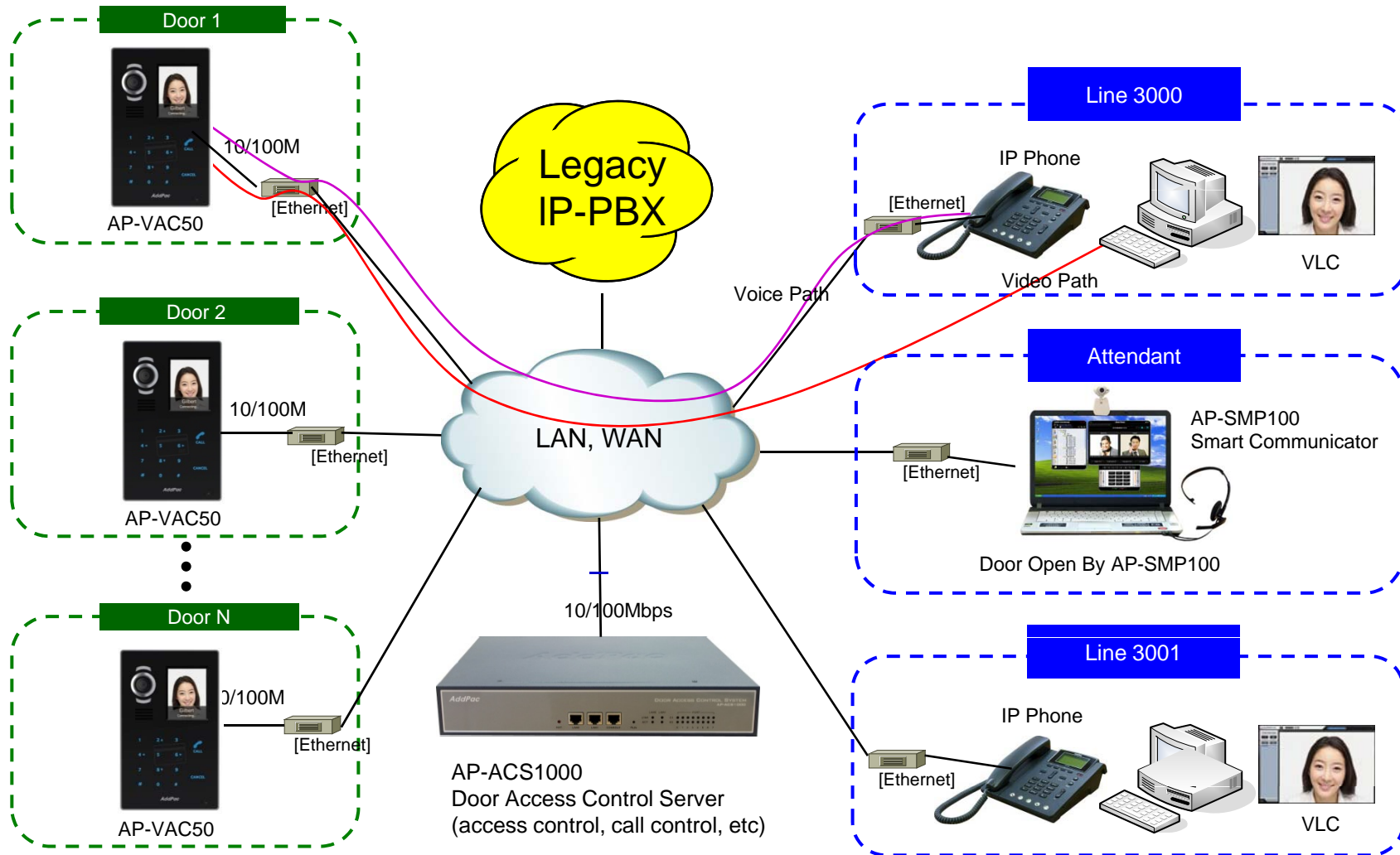

Network Diagram

Interworking with Smart Communicator

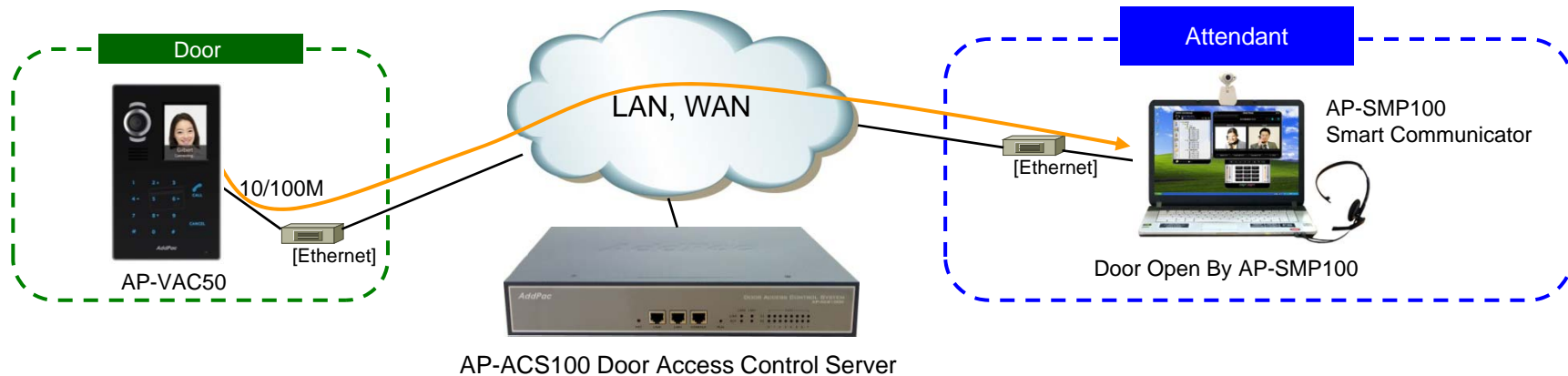

- Door Open By AP-SMP100 Soft key (Feature Code)
- AP-VAC50 security Option
 - Video Display Mute (Local View Only)
- AP-SMP100 security Option
 - Local Camera Mute (Privacy) On/Off
 - Support Camera Mute Image



DACS System Message Flow

DACS System Message Flow

Registration and Keep Alive

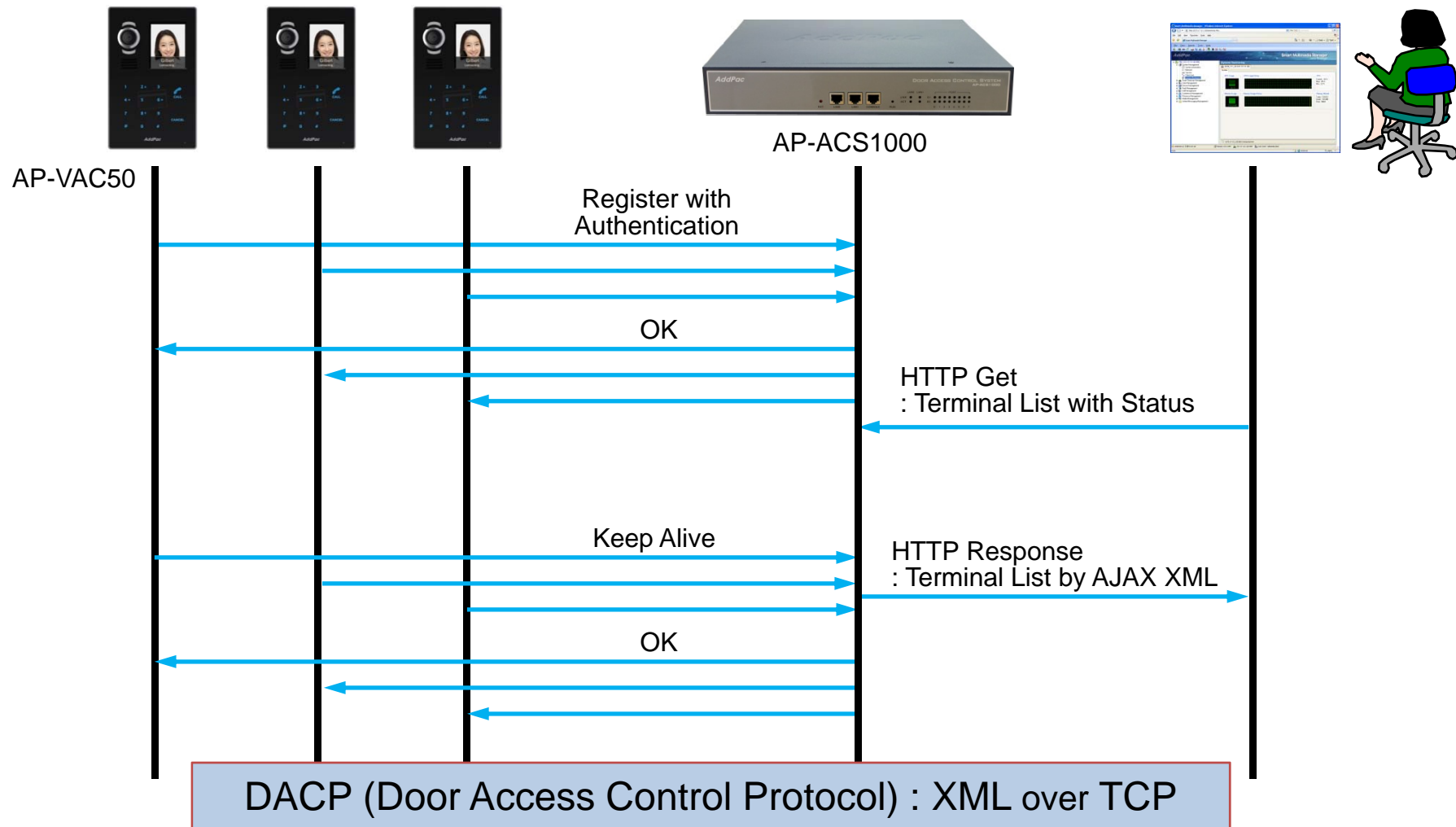

DACS System Message Flow

Access Privilege and Schedule Download

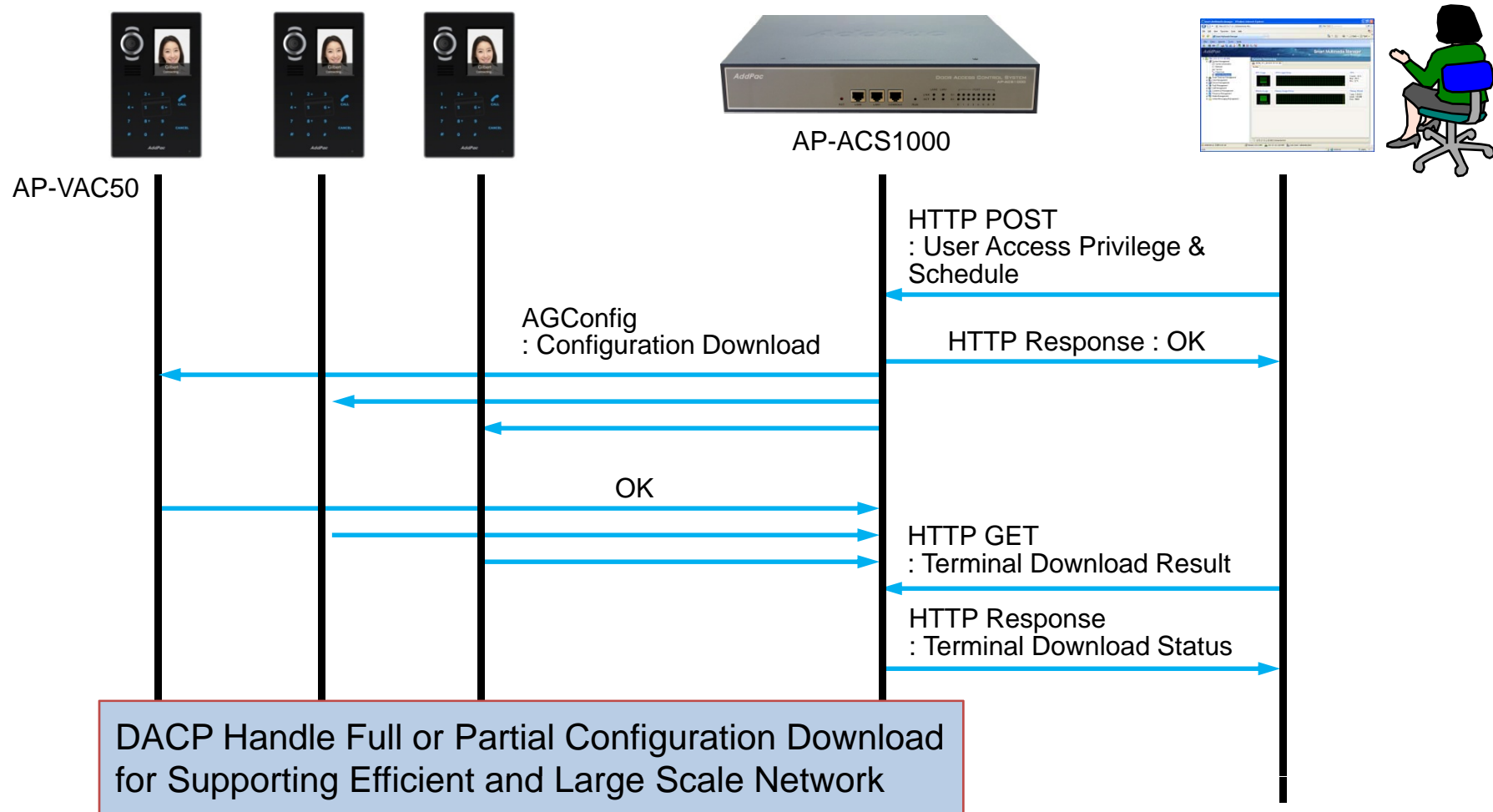

DACS System Message Flow

RF Card Read/Write and Registration

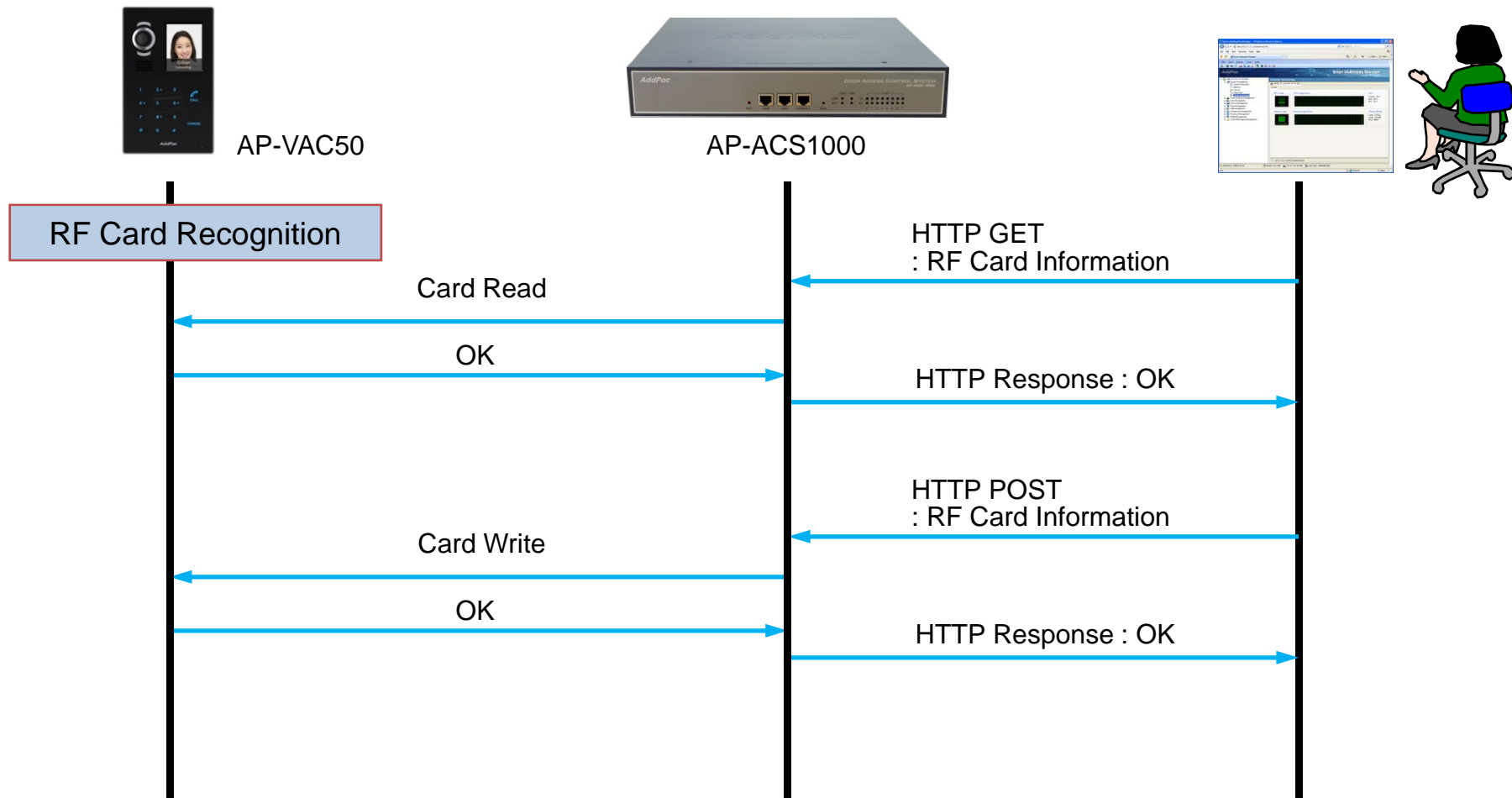

DACS System Message Flow

Door Open by RF Card or Password

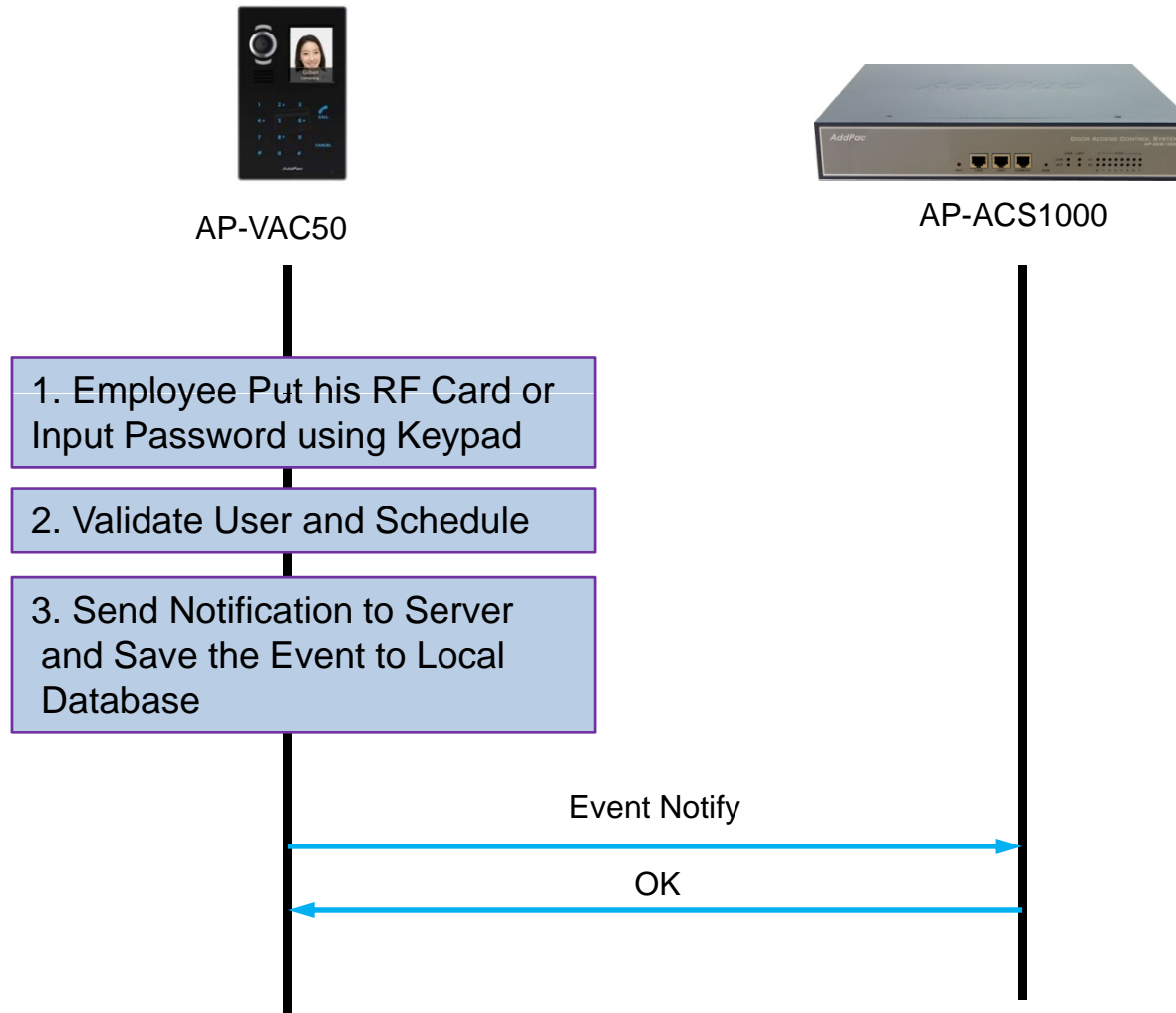

DACS System Message Flow

Door Open by AP-SMP100 Smart Communicator

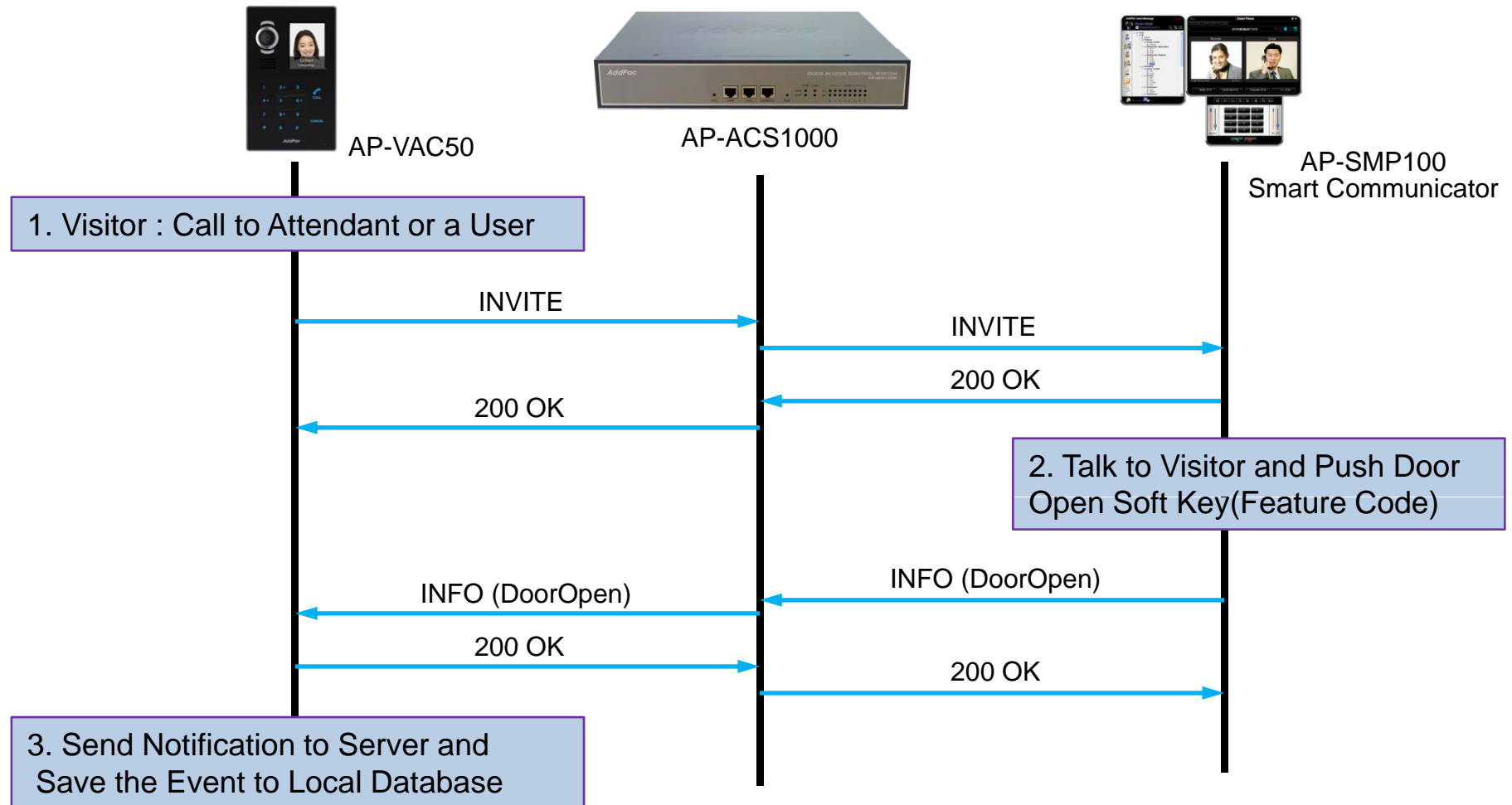



Thank you!

AddPac Technology Co., Ltd.
Sales and Marketing

Phone +82.2.568.3848 (KOREA)

FAX +82.2.568.3847 (KOREA)

E-mail sales@addpac.com