

AP-MG3000 IP Call Center Application

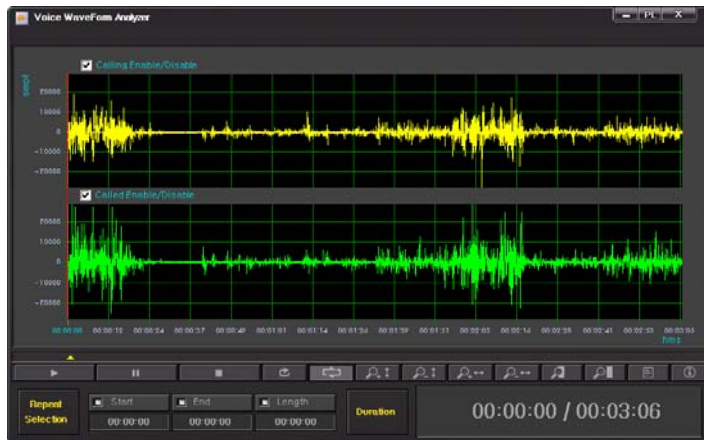

AddPac

AddPac Technology

Sales and Marketing

Contents

- Network Diagrams
- Product Specifications
 - IPNext3000 SIP Server for Call Center
 - AP-AS10000 Application Server
 - Voice Recording Server : AP-NR3000 (commercial server)
 - Voice Transcoder (Option): AP-VTC1000
 - Media Gateways for Voice Recording Extension: AP-MG3000, etc
 - Smart Digital Voice Recording Management Program

Network Diagram

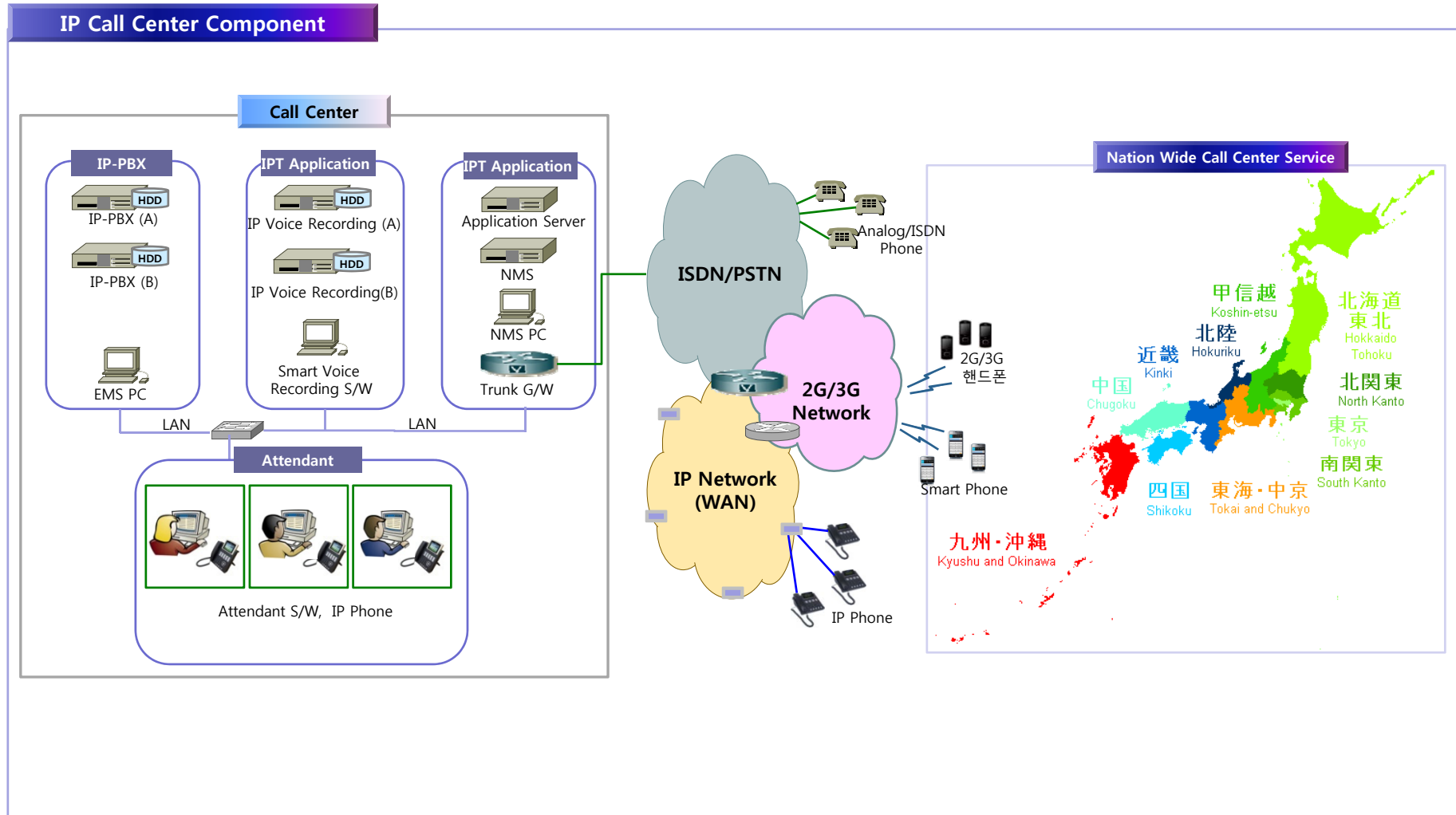

Network Diagram

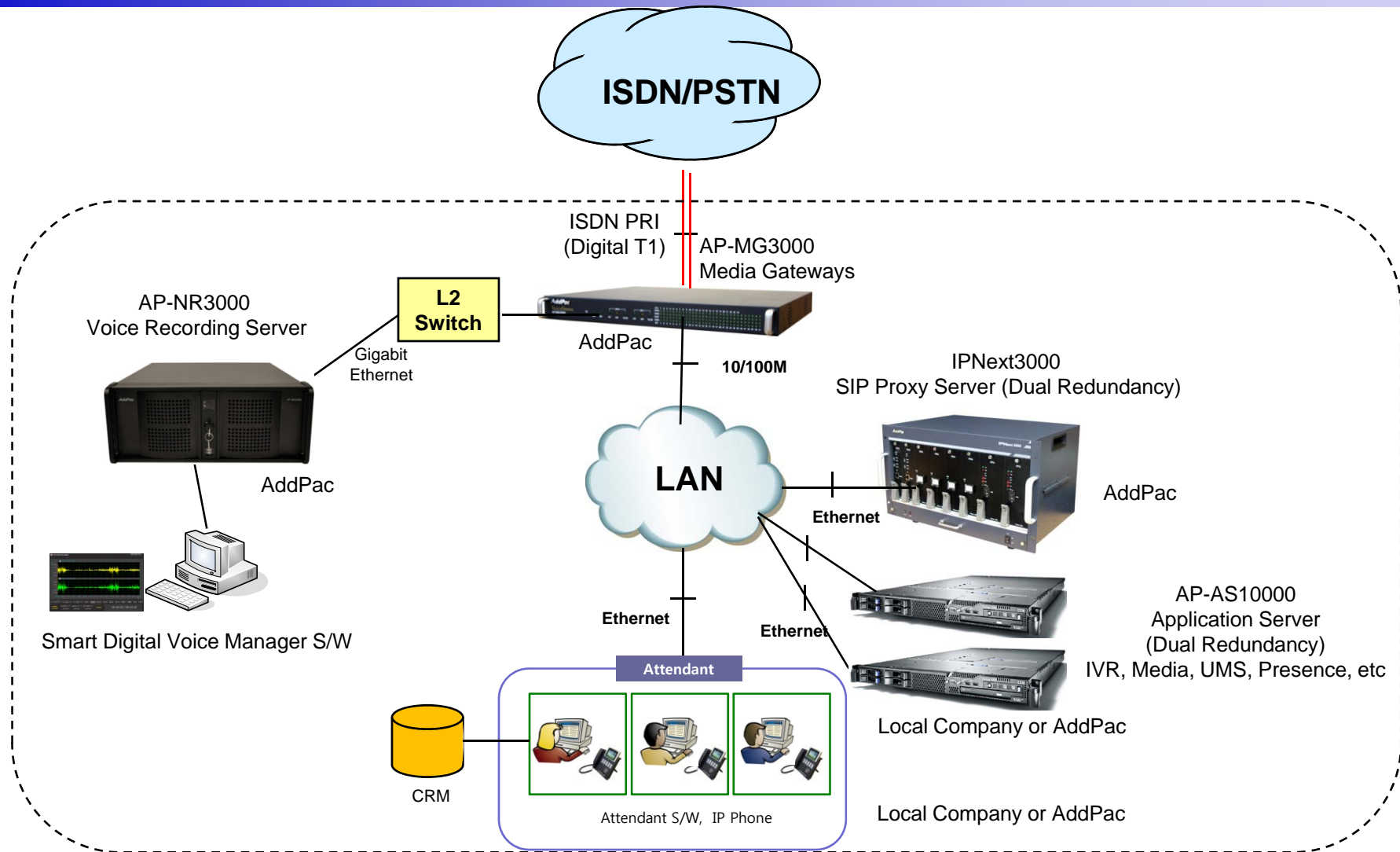



IPNext3000 SIP Proxy Server

Product Overview

- SIP Application Server, Proxy, Registrar and Location Server(RFC3261)
- IPv4/IPv6 based Dual Network Protocol Support
- Internal RTP Proxy Function Support
- Internal Presence Function Support with Smart Messenger
- SIP, H.323 Signaling for Outbound Calls
- Various Call Scenario (Call Pickup, Call Park, Call Transfer, etc)
- Various IP Terminal Support
- Powerful Management and User Friendly Features
- Fault Tolerant and Scalability Architecture
- High-performance Video, Audio, and Voice Service
- Firmware Upgradeable Architecture
- Dual System Redundancy Architecture
 - Two(2) 3.5 Inch SATA Hard Disk (RAID 1) / System
 - Two(2) Gigabit Ethernet Interface / System
- Dual Redundancy Power Module

H/W Diagram

IPNext 3000 Front Side

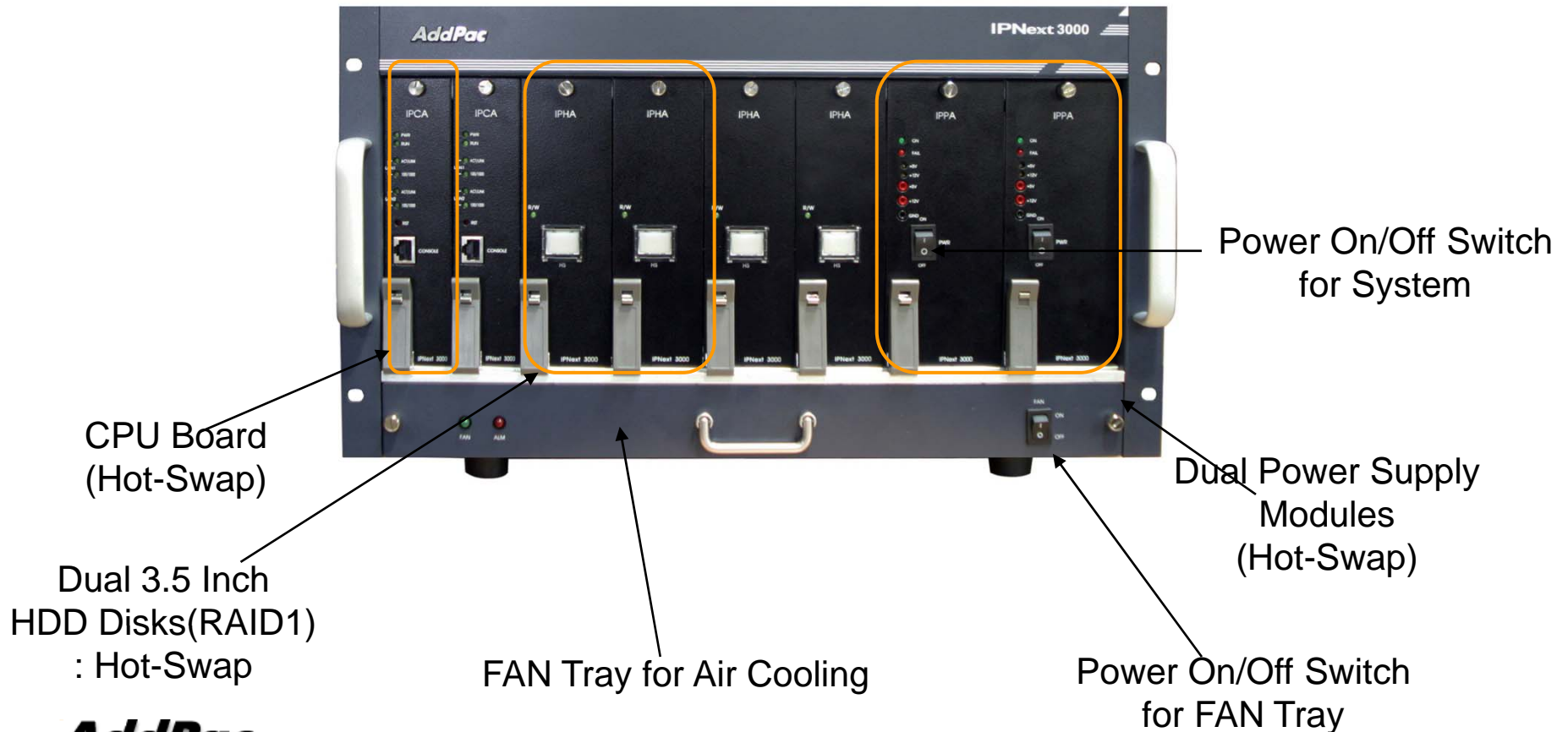

H/W Diagram

IPNext 3000 Back Side

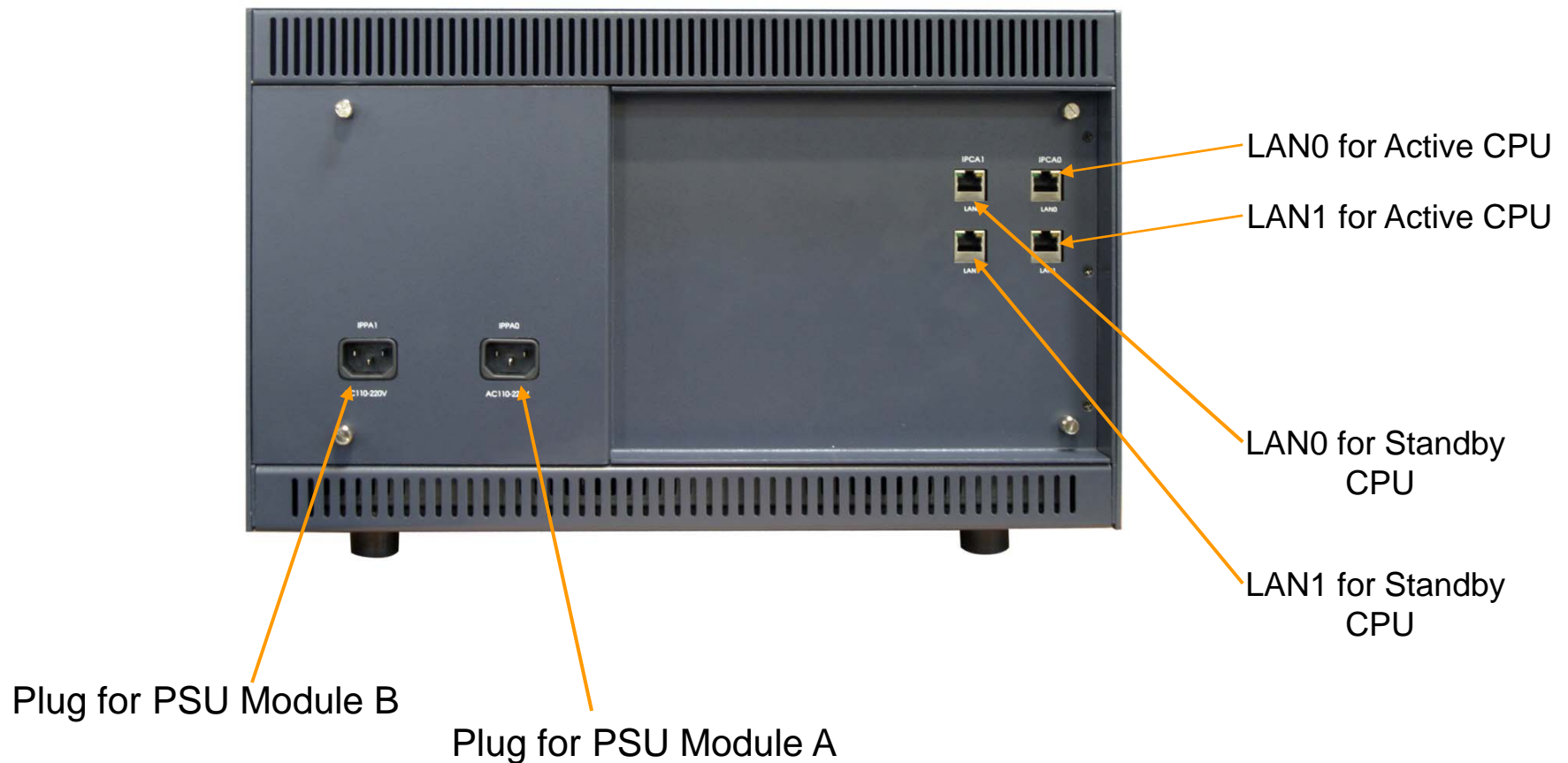

Redundancy Architecture

IPNext3000 System Block Diagram

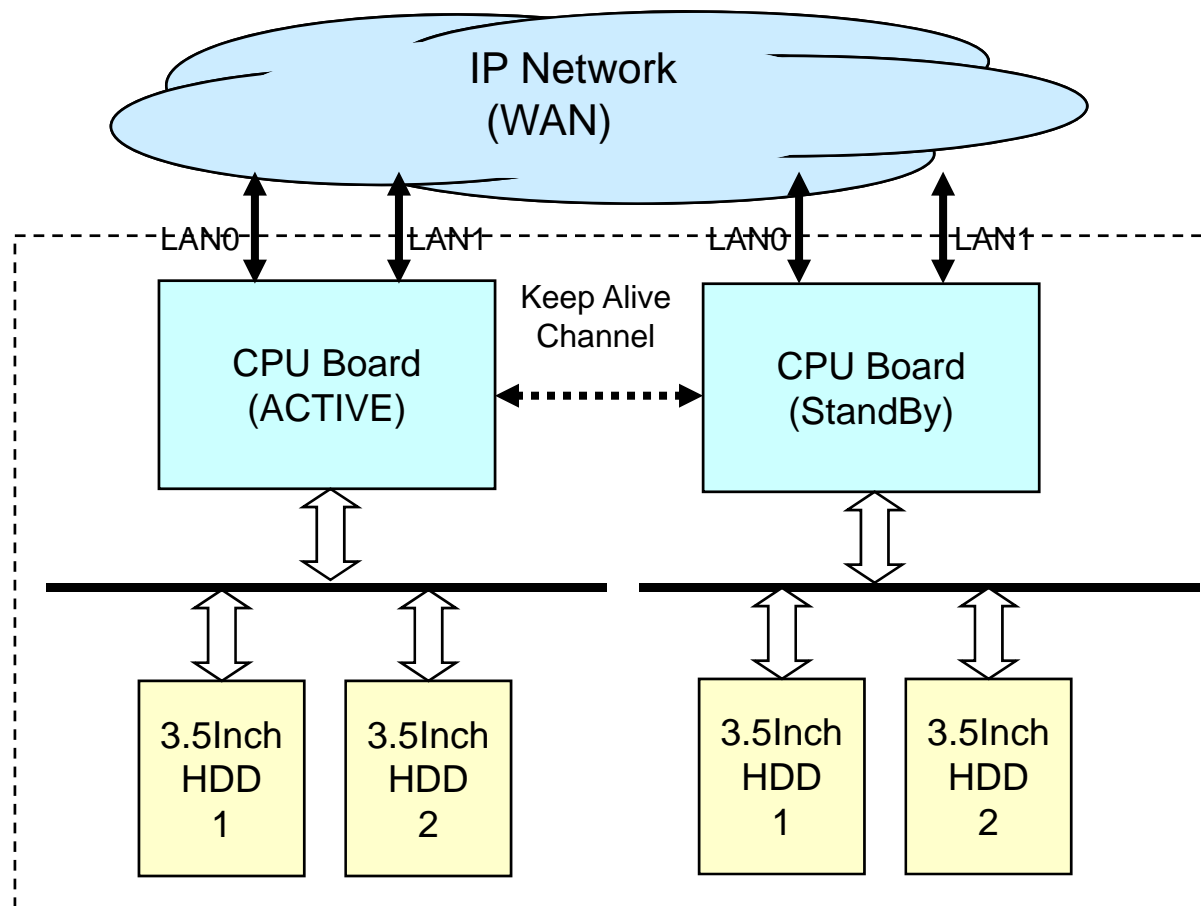



AP-AS10000 Application Server (option)

Product Overview

- Commercial Hardware Platform(IBM, HP, etc)
- Linux Operating System
- IPv4/IPv6 based Dual Network Protocol Support
- IVR Service
- Media Service
- UMS Service* (IP-PBX Appl.)
- Presence Service*(IP-PBX Appl.)
- RTP Proxy Service for Private IP* (IP-PBX Appl.)
- Firmware Upgradeable Architecture





AP-NR3000 IP Voice Recording Server

Product Overview

AP-N3000 Network Voice Recoding Server

- IP based Network Voice Recording Server
- Linux Operating System
- Powerful Management and User Friendly Features
- High-performance Voice Recoding Service
- External Media Gateway(ex:AP-MG3000) Interworking Support
- Firmware Upgradeable Architecture
- One(1) 10/100/1000Mbps Gigabit Ethernet Interface
- One(1) DVD Writer for Audio File Backup
- Up to Four(4) 3.5Inch SATA Hard Disk Interface Support
- USB Interface Support (Front Side, Back Side)

Hardware Specification

AP-N3000 Network Voice Recoding Server

- High Performance Computing Power
- Main Chassis
 - Network Interface
 - One(1) 10/100/1000Mbps Fast Ethernet
 - Video Output Interface
 - HDMI, DVI,RGB Video Output
 - USB 2.0 Interfaces for Mouse, Keyboard, etc
 - One(1) DVD Writer for Video File Backup
 - Up to Four(4) Hard Disk





Voice Transcoder

AP-VTC1000 Voice Transcoder





- Embedded Platform
- High-End 64bit RISC Processor
- Real-time Voice Transcoding (Ex: G.729->G.711, etc)
- RTP/RTSP Support
- RISC Microprocessor Computing Power
- Network Interface
 - Two(2) 10/100Mbps Fast Ethernet
 - One(1) RS-232C Console
- DSP Module for Voice Transcoding
 - 32 Channel DSP Module
 - 64 Channel DSP Module
 - Voice Codec : G.711, G.729, G. 723.1, G.726, etc



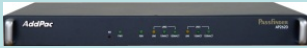

Media Gateways for Voice Recording Extension

VoIP Gateways with Voice Recording Extension

Product	AP2620	AP2640	AP2650	AP-MG3000
				
Available Modules	AP-FXS4 AP-FXO4 AP-FXS2O2 AP-E&M4 AP-E1	AP-FXS8 AP-FXO8 AP-FXS4O4 AP-E&M8 AP-E1	AP-FXS8 AP-FXO8 AP-FXS4O4 AP-E&M8 AP-E1	APv2-1E1 APv2-2E1 APv2-4E1
Analog Ports	Up to 8	Up to 32	Up to 32	N/A
Signaling	SIP, H.323	SIP, H.323	SIP, H.323	SIP, H.323
Digital E1/T1	Up to 2E1/T1	Up to 2E1/T1	Up to 2E1/T1	Up to 4E1/T1
E&M	Support	Support	Support	N/A
Module Slot	Two(2)	Four(4)	Four(4)	Two(2)
LAN Port	2	2	2	2
Console	1	1	1	1
Power	Single PSU	Single PSU	Dual PSU	Single PSU

AP-MG3000 Media Gateway

- Voice Recording Interface Support
- ISDN PRI Digital E1/T1 VoIP Interface
- Up to 4T1 Interface
- IPv4/IPv6 Address Support
- Two(2) Module Slots for Digital E1/T1 Interface
- SIP, H.323, MGCP VoIP Signaling Support
- Firmware Upgradeable Architecture





Smart DVoiceR Management Program for Voice Recording Server

Smart DVoice^R Management Program

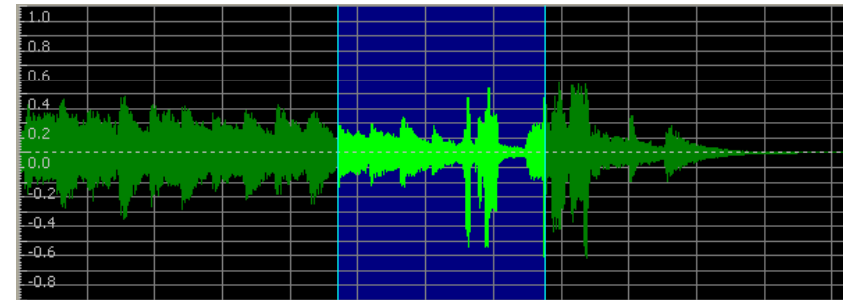
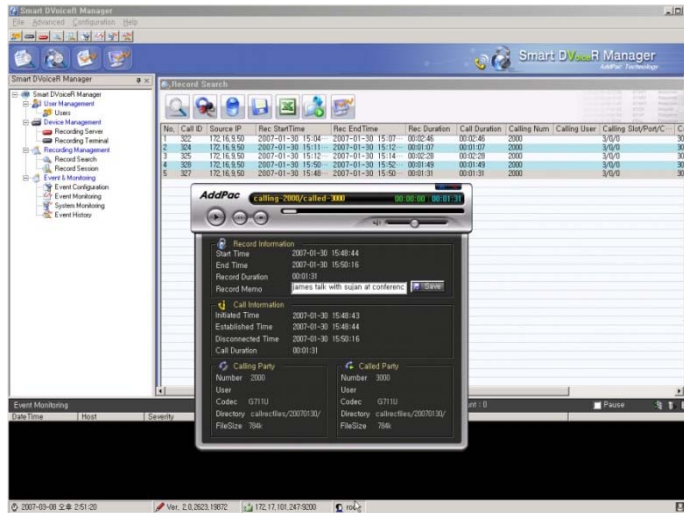

- Call History Management (search/modify/delete/save)
- Media Play Management (Play/Stop/Seek/Pause)
- Live Call List Management, Live Call Monitoring
- Local Backup (File Manager Support, PC HDD, DVD) and Local Play
- User Management (registration/modify/delete/search)
- Server Status (CPU/Memory/HDD) & Event Monitoring
- Waveform Analyzing Function
- Recording Source Management (VoIP Gateway, IP Phone, etc)
- Live Recording Board



Thank you!

AddPac Technology Co., Ltd.
Sales and Marketing

Phone +82.2.568.3848 (KOREA)

FAX +82.2.568.3847 (KOREA)

E-mail sales@addpac.com