

AP1601N

IP High Quality Audio Broadcasting Terminal

High Performance IP based Multichannel IP High Quality Audio Broadcasting Terminal



MBMS Management Software



AP1601N Broadcasting Terminal



HQA Module



AP-ABS5000 Broadcasting Server

AddPac

AddPac Technology

Sales and Marketing

www.addpac.com

Contents

- Product Overview
- Product Highlight
- Hardware Specification
- APOS™ Service Features
- IP Audio Broadcasting Signal Flow
- Unicast & Multicast Service Feature
- MBMS v2.0 Software Features
- IP Audio Broadcasting Solution
- Application Area
- Ordering Information

Product Overview

AP1601N IP High Quality Audio Broadcasting Terminal

- IP based Audio Broadcasting Terminal Solution
- Hardware Architecture for Audio Broadcasting Terminal Service
- One(1) Module Slot for Audio Encoding & Decoding Service
- Remote Broadcasting Service at terminal side
- High Quality Audio Codec Support (G.711, etc)
- Unicast and Multicast Broadcasting Scheme
- Enhanced MBMS (Multimedia Broadcasting Management System) Support
- One(1) channel Audio IN/OUT Port
- On-AIR Blue LAMP
- High-Quality Audio/Voice Service
- Firmware Upgradeable Architecture
- Broadcasting Solution with Outstanding Network Service Capability

Product Highlights

AP1601N IP High Quality Audio Broadcasting Terminal

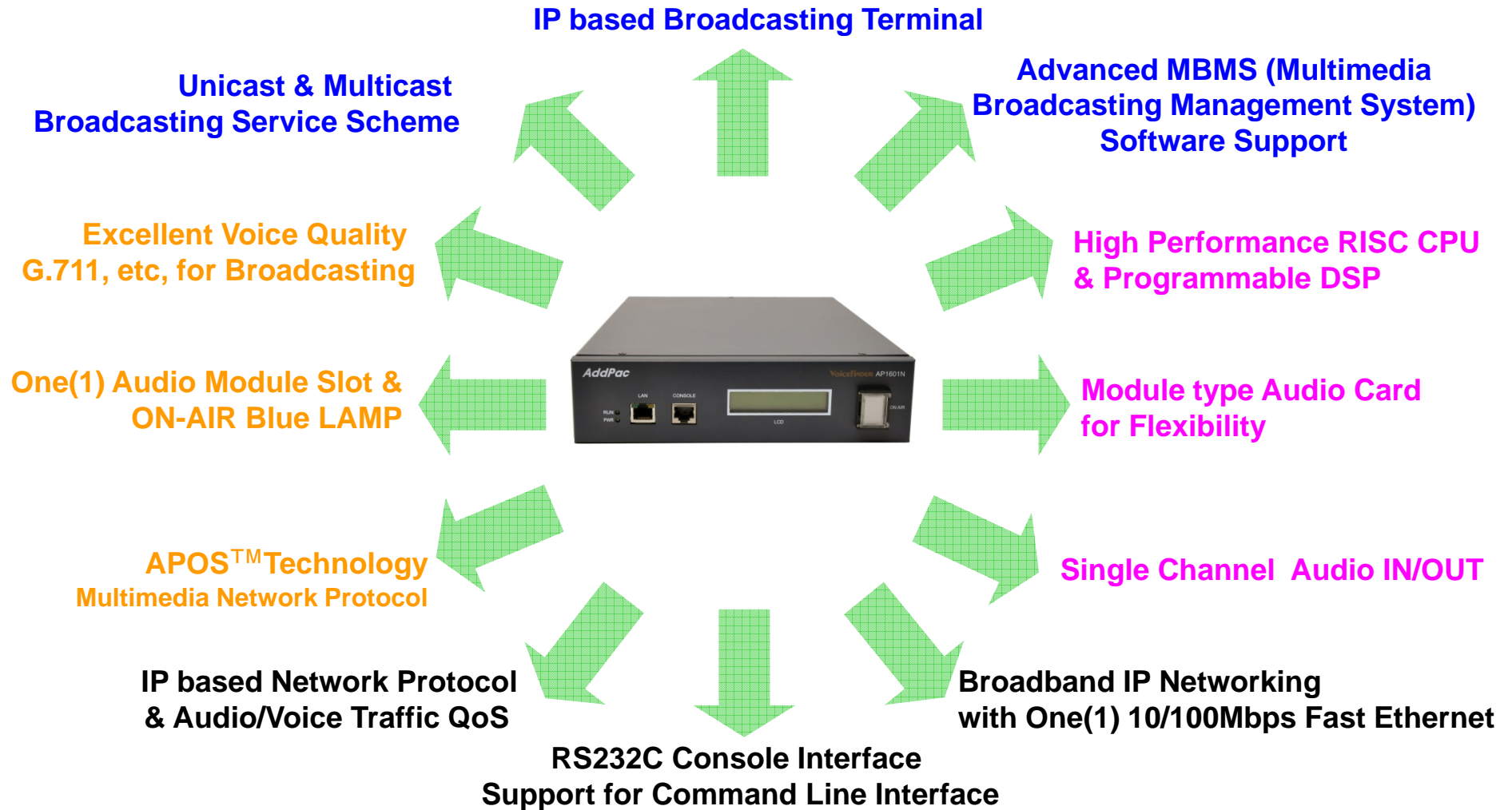

Hardware Specification

AP1601N IP High Quality Audio Broadcasting Terminal



RISC
CPU



High-end
DSP

- RISC Microprocessor Computing Power
- High-end Programmable DSP Hardware Architecture
- One(1) Module Slot for Audio Broadcasting Codec Module
- High Quality Audio Encoding/Decoding Service
- ON-AIR Blue LAMP
- High Quality Audio and Voice Interface
 - Stereo Audio Input Connector
 - Stereo Audio Output Connector
- Network Interface
 - One(1) 10/100Mbps Fast Ethernet (RJ45)
 - One(1) RS-232C Interface (RJ45) for Command Line Interface

Hardware Specification

AP1601N IP High Quality Audio Broadcasting Terminal

RISC
CPU

High-end
DSP

AP1601N Front Side



Fast Ethernet
(LAN0, LAN1)

RS232C Console

Status LCD

On-Air Blue LAMP

AddPac

www.addpac.com

AP1601N Back Side



Audio
Input

Audio
Output

Audio Port
Active LED

Audio Broadcasting Service
Module

Hardware Specification

AP1601N IP High Quality Audio Broadcasting Terminal

RISC
CPU

High-end
DSP

AP-N1-HQA1000 Board



Audio IN
(MIC, Line IN)

Audio OUT
(HP, Line OUT)

ON-AIR Blue LAMP

Hardware Specification

AP1601N IP High Quality Audio Broadcasting Terminal

RISC
CPU

High-end
DSP

AP1601N Audio Module

Audio Module Type (AP-N1-HQA1000)	Audio Module Features
 The image shows the AP-N1-HQA1000 audio module, a black rectangular device with a green PCB on top. It features several ports: a microphone input (MIC), a line input (LINE IN), a line output (LINE OUT), and a headphone output (HP). There are also two 3.5mm stereo jacks for audio input and output. A small display or indicator is visible on the right side of the front panel.	One(1)-Channel Audio In/Out Port
	Audio Encoding/Decoding Service
	Audio IN : MIC, Line IN Audio OUT : Headphone, Line OUT 3.5mm Stereo JACK
	High Quality G.711, etc, Audio Codec

AP-HQA Module

AP1601N IP High Quality Audio Broadcasting Terminal

RISC
CPU

High-end
DSP

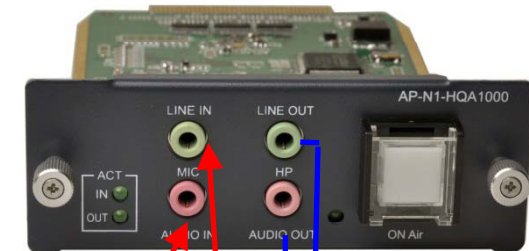

Connect with 1:2 Stereo Jack

Connect with 2:1 Stereo Jack

Direct MIC

- High quality codec realizes high quality audio service
- Direct MIC-In/ Headphone In Port for monitoring
- Real time High Quality Audio Band Broadcasting



Headphone

APOS™ Service Features

AP1601N IP High Quality Audio Broadcasting Terminal

- **APOS Internetworking Software**

- AddPac Operating System (APOS)
- Support Industry Standard
- Integrated Networking Protocols
- Optimized Performance & Functionality
- Easy to use, Installation, and Maintenance

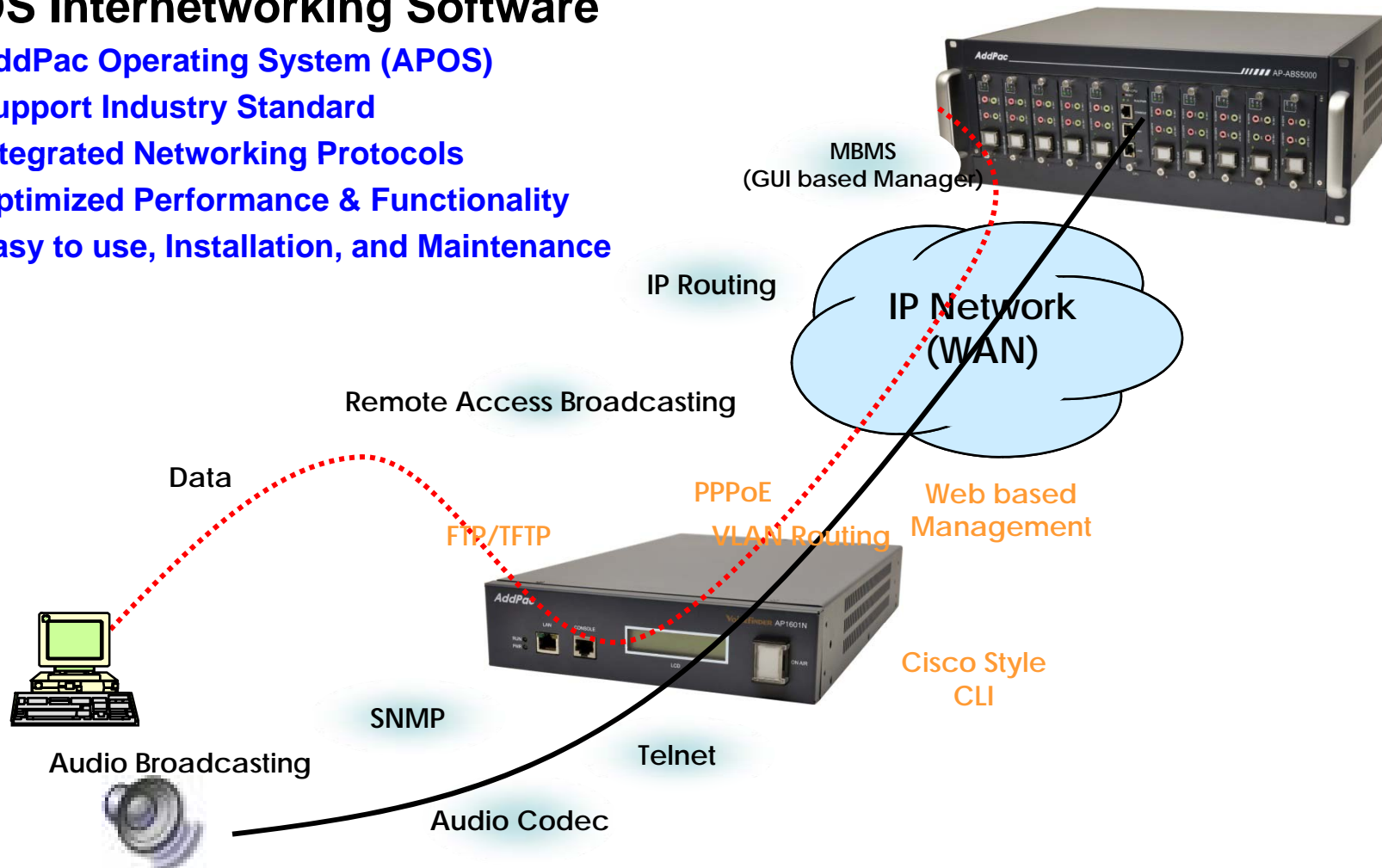

APOS™ Service Features

AP1601N IP High Quality Audio Broadcasting Terminal

- **IP Routing Protocols**

- Multi-protocol Internetworking Services
- Static & Default IP routing

- **WAN Protocols**

- Point-to-Point Protocol (PPPoE for ADSL)
- IEEE 802.3 Ethernet
- PPTP support for secure communication

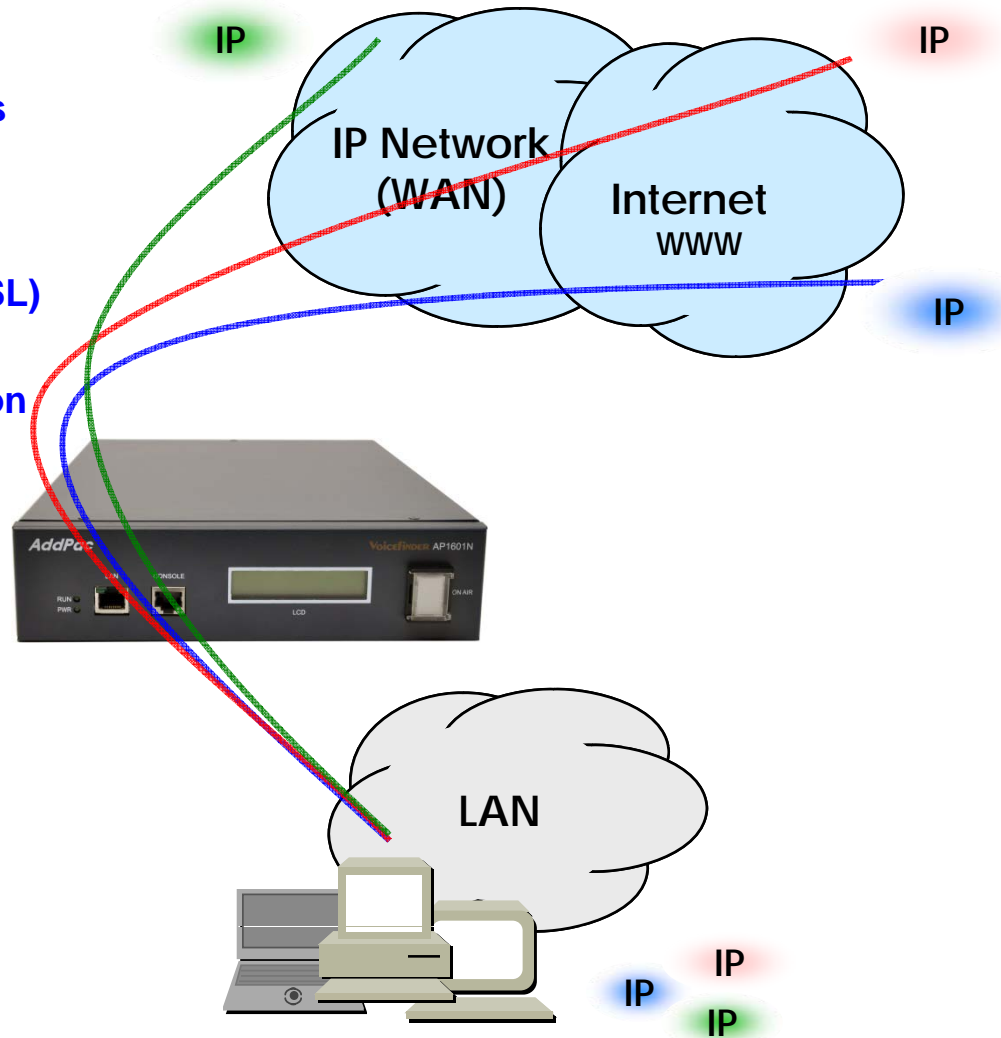

APOS™ Service Features

AP1601N IP High Quality Audio Broadcasting Terminal

- **Network Managements**
 - Standard SNMP Agent (MIB v2) Support
 - Remote Management using Console, Telnet
 - Web based Management using HTTP Server Interface
- **Security Functions**
 - Standard & Extended IP Access List
 - Enable/Disable for Specific Network Protocols
 - Multi-level User Account Management
 - Auto-disconnect for Telnet/Console Sessions
 - PPP User Authentication Supports (PAP & CHAP)
- **Operation & Managements**
 - System Performance Analysis for Process, CPU, Connection Interface
 - Debugging, System Auditing, and Diagnostics Support
 - System Booting and Auto-rebooting with Watchdog Feature
 - System Managements with Data Logging
 - IP Traffic Statistics with Accounting

APOS™ Service Features

AP1601N IP High Quality Audio Broadcasting Terminal

- **Network Protocols**

- DHCP Server & Relay Functions
- Network Address Translation (NAT) Function
- Port Address Translation (PAT) Function
- Transparent Bridging (IEEE Standard) Function
 - Spanning Tree Bridging Protocol Support
 - Remote Bridging Support
 - Concurrent Routing and Bridging Support
- Cisco Style Command Line Interface (CLI)
- Network time Protocol (NTP) Support

- **MBMS (Multimedia Broadcast Management System)**

- MS Windows Graphical User Interface (GUI) based Audio Broadcasting Management
- Service Group Configuration
- Scheduled Broadcasting
- Status Monitoring
- Report Service
- Embedded Media file Manager

APOS™ Service Features

AP1601N IP High Quality Audio Broadcasting Terminal

- Audio Codec for AP-HQA Module
 - G.711 Audio Codec, etc

IP Broadcasting

- RTP Protocols
 - Redundant RTP packet transmission in case of severe packet loss
 - Dynamic jitter buffer management and RPT packet jitter and loss compensation with heuristic & DSP error concealment
 - Static jitter buffer setting support
 - Voice frame per RTP packet number control for each codec



IP Audio Broadcasting Signal Flow

AP1601N IP High Quality Audio Broadcasting Terminal

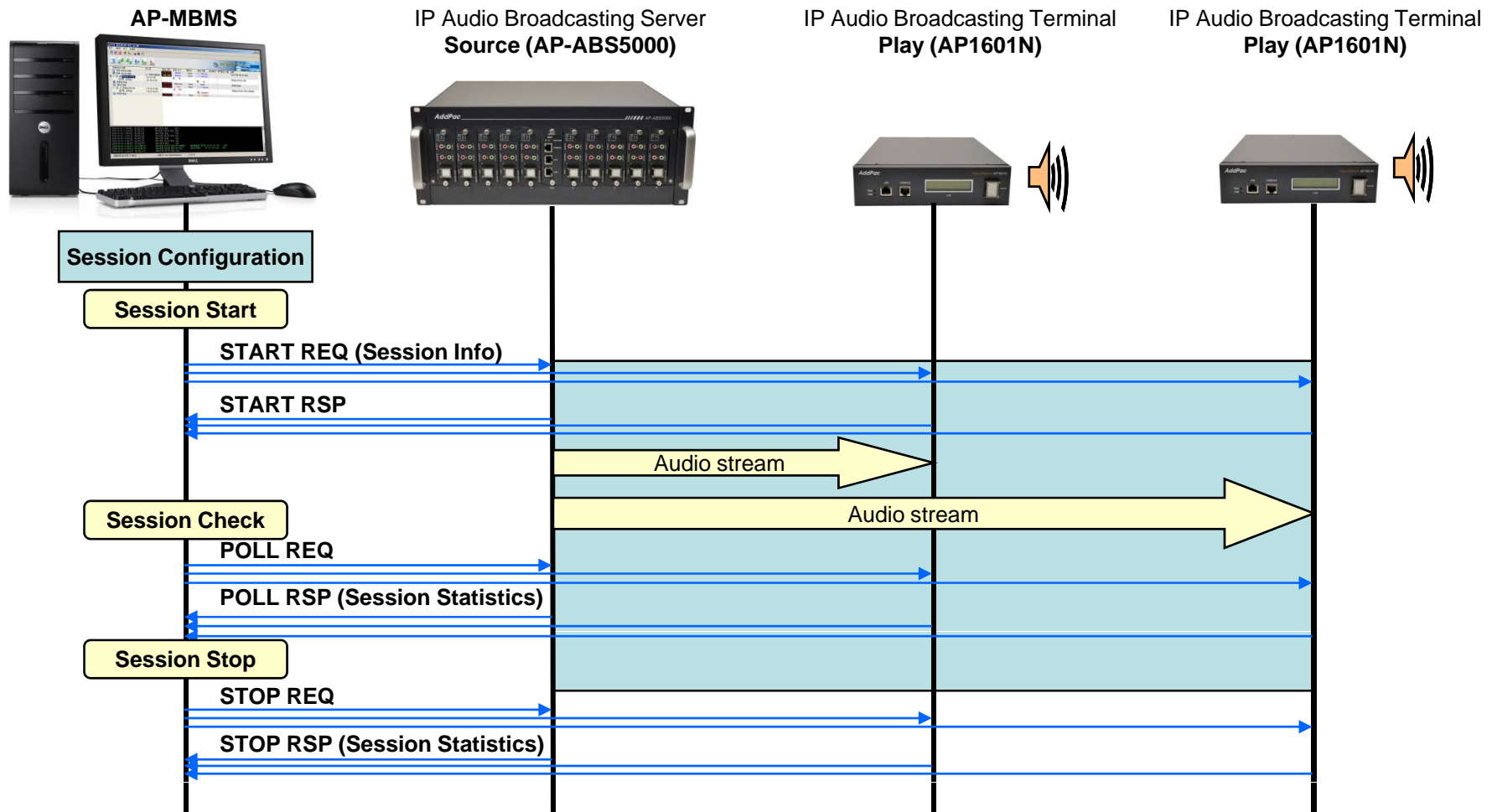

Multicast Service Network Diagram

AP1601N IP High Quality Audio Broadcasting Terminal

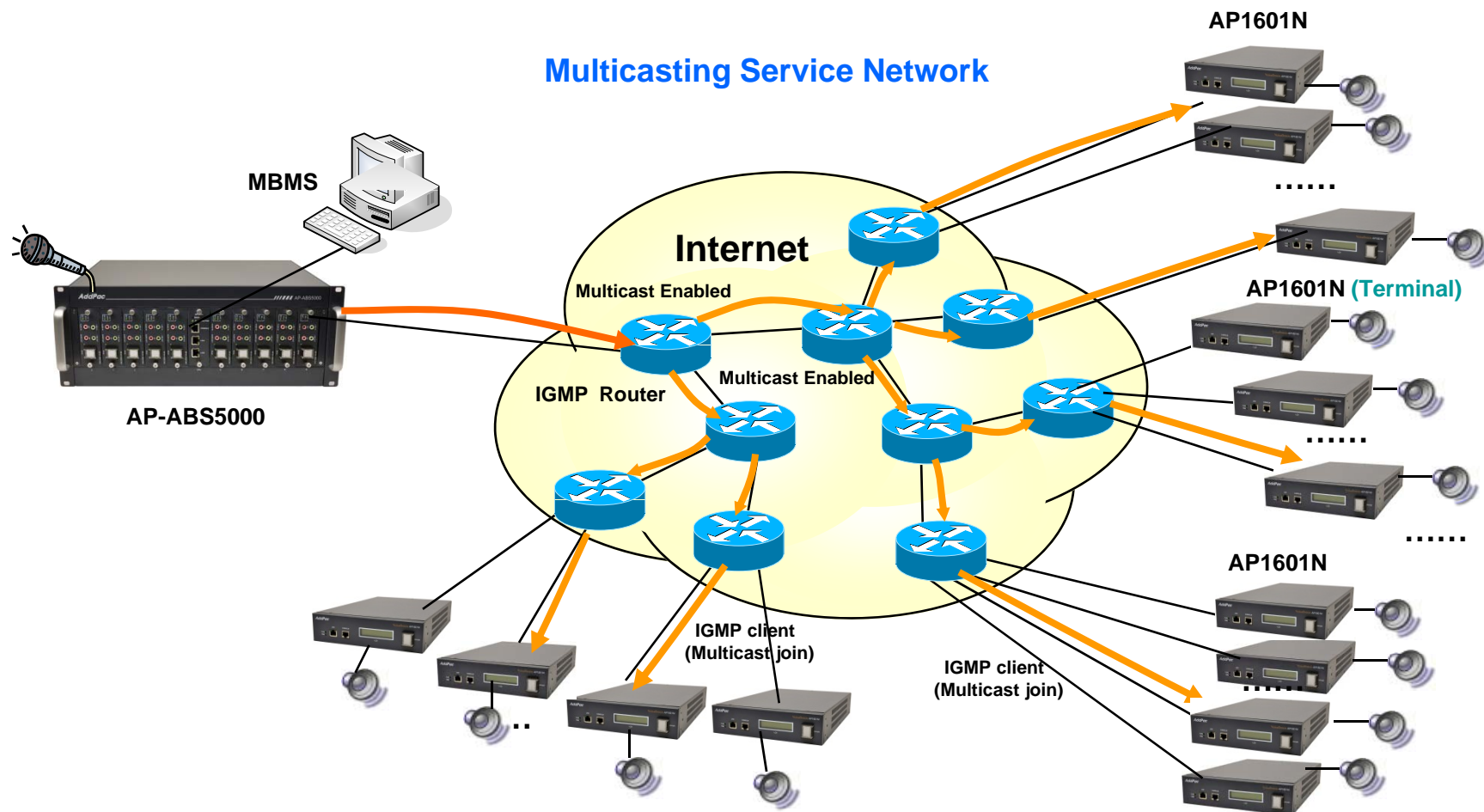

- Multicast protocol based such as **IGMP Protocol**
- Available to broadcast multi destination with single channel bandwidth

Unicast Service Network Diagram

AP1601N IP High Quality Audio Broadcasting Terminal

Unicasting Service Network

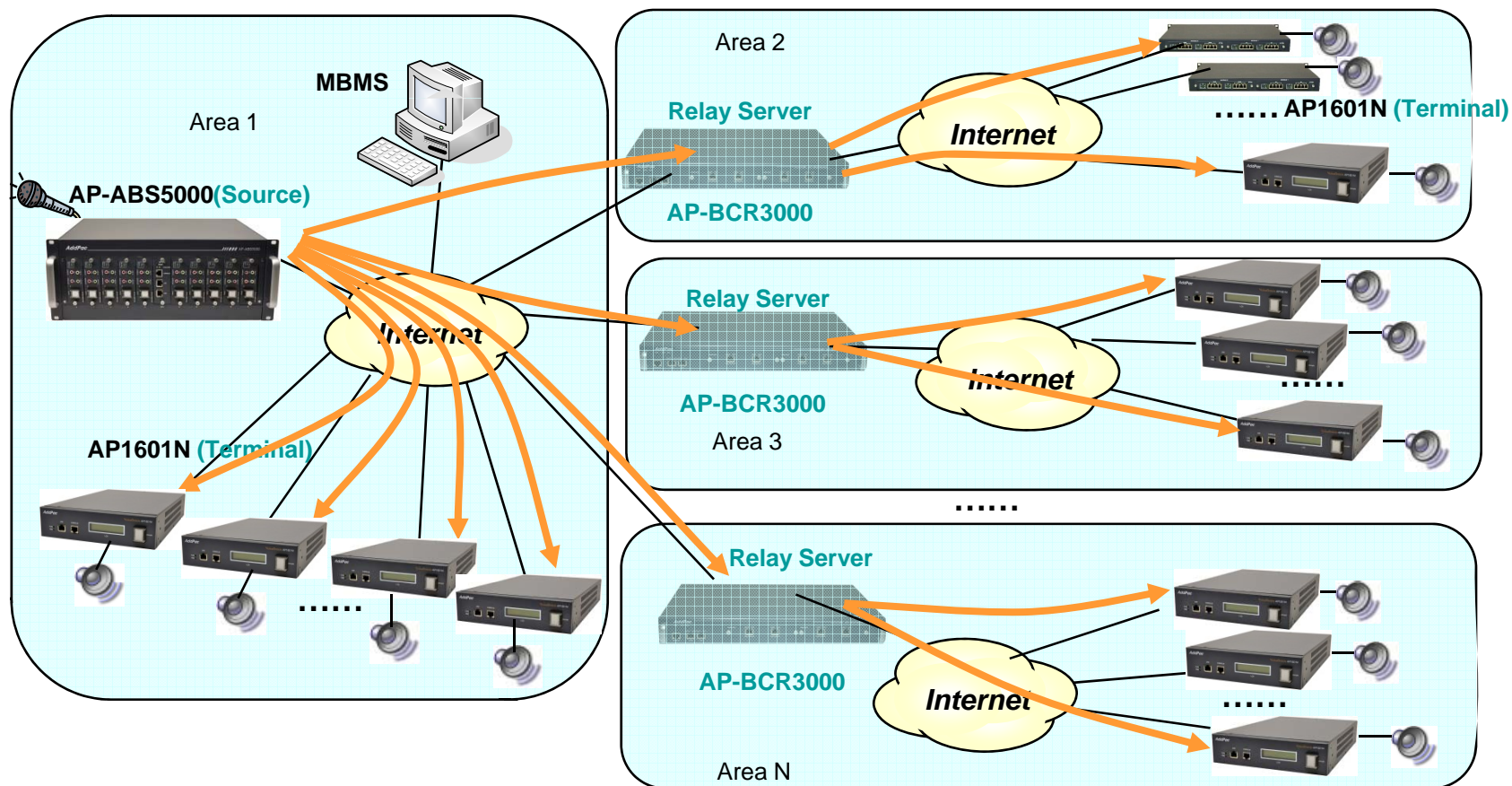

MBMS 2.0 Software Features

AP1601N IP High Quality Audio Broadcasting Terminal

- User Registration Management
- User Access Restriction
- Broadcasting System Management
- Broadcasting Session Management
- Scheduling Broadcasting and On-time Broadcasting
- Emergency Broadcasting Management
- Scheduling Stop Management
- Event Log Management
- MBMS System Redundancy & Auto Data Backup

MBMS 2.0 Software Features

AP1601N IP High Quality Audio Broadcasting Terminal



MBMS S/W Startup (Example)

AP1601N IP High Quality Audio Broadcasting Terminal

방송세션 이름	호스트	방송 상태	방송 소스	릴레이	방송 단말	방송예약	예약방송 이름	설명
전체 비디오 방송		ON-AIR	Normal	None	1 / 1 Normal			학교 전체 비디오 방송
전체 오디오 방송	화재긴급방송	ON-AIR	Normal	None	1 / 1 Normal			
▶ 방송실 오디오	172.16.7.55		Ok		Ok			방송실 오디오 서버
교무실1	172.16.19.101				Ok			
운동장 방송		ON-AIR	Unknown	None	None			운동장 방송
1학년 방송		ON-AIR	Fail	None	1 / 1 Normal			
▶ 방송실 비디오	172.16.19.102		Fail		NoSESS			방송실 비디오 서버 (AP5840)
교무실1	172.16.19.101				NoSESS			
2학년 방송		ON-AIR	Fail	None	0 / 1 Normal			

[2006-05-09 11:44:46]	BC_POLL [5]	SNA=1학년 방송	[Ok]				
[2006-05-09 11:44:58]	BC_POLL [1]	SNA=전체 오디오 방송	[Ok]				
[2006-05-09 11:45:06]	BC_POLL [5]	SNA=1학년 방송	[Ok]				
[2006-05-09 11:45:16]	BC_POLL [1]	SNA=전체 오디오 방송	[Ok]				
[2006-05-09 11:45:26]	BC_POLL [5]	SNA=1학년 방송	[Ok]				
[2006-05-09 11:45:37]	BC_POLL [1]	SNA=전체 오디오 방송	[Ok]				
[2006-05-09 11:45:46]	BC_POLL [5]	SNA=1학년 방송	[Ok]				
[2006-05-09 11:45:51]	BC_START [1]	SNA=전체 오디오 방송	NTY=SOURCE	ENA=방송실 오디오	IP=172.16.7.55	[Ok]	
[2006-05-09 11:45:51]	BC_START [1]	SNA=전체 오디오 방송	NTY=PLAY	ENA=교무실1	IP=172.16.19.101	[Ok]	
[2006-05-09 11:45:56]	BC_POLL [1]	SNA=전체 오디오 방송	[Ok]				

2006-05-09 오전 11:46:01 사용자: root (administrator) 1,0,0,14

Broadcasting Equipment Management (Example)

AP1601N IP High Quality Audio Broadcasting Terminal

방송장비 이름 (방송 이름)	호스트 주소 (ON...	장비 모델명	입력포트	출력 포트	설명	포트 이름
과학실	1.1.1.1	AP1601				
교무실 1	172.16.19.101	AP2520				
1학년 방송			1-1	1-1		
2학년 방송			0-1	0-1		
전체 오디오 방송			1-1	1-1		
미술실	1.1.1.2	AP2120				
방송실 비디오	172.16.19.102	AP5840			방송실 비디오...	
1학년 방송			2-1	2-0		
2학년 방송			1-1	1-0		
전체 비디오 방송			1-1	1-0	학교 전체 비...	
방송실 오디오	172.16.7.55	AP3150			방송실 오디오...	
전체 오디오 방송			7-1	7-1		
비디오 단말	172.16.39.24	AP-VP300			vp200 단말	
전체 비디오 방송			0-1	0-0	학교 전체 비...	

Total : 6 Selected count : 1

2006-05-09 오후 12:00:43 사용자: root (administrator) 1.0.0.14

Broadcasting Configuration (Example)

AP1601N IP High Quality Audio Broadcasting Terminal

학교 멀티미디어 방송 시스템

관리 사용자 보기 도움말

학교 멀티미디어 방송 시스템
AddPac

방송채널 구성

방송채널 이름: 전체 오디오 방송

방송 장비 이름	IP 주소
방송실 오디오	172.16.7.55
교무실1	172.16.19.101

방송 장비 이름	IP 주소	설명	포트 설명
과학실	1,1,1,1		
AP-AUDIO2	(0/1, 0/1)		
AP-AUDIO2	(0/0, 0/0)		
교무실1	172.16.19.101		
AP-AUDIO2	(1/0, 1/0)		
AP-AUDIO2	(1/1, 1/1)		
AP-AUDIO2	(0/1, 0/1)		
AP-AUDIO2	(0/0, 0/0)		
미술실	1,1,1,2		
AP-AUDIO2	(1/1, 1/1)		
AP-AUDIO2	(1/0, 1/0)		
방송실 비디오	172.16.19.102	방송실 비디...	
AP-AV1000	(2/1, 2/0)		
AP-AV1000	(1/1, 1/0)		
방송실 오디오	172.16.7.55	방송실 오디오...	
AP-AUDIO2	(7/1, 7/1)		
AP-AUDIO2	(7/0, 7/0)		
AP-AUDIO2	(6/1, 6/1)		
AP-AUDIO2	(6/0, 6/0)		
AP-AUDIO2	(5/1, 5/1)		

Total : 6

2006-05-09 오후 12:18:22 사용자: root (administrator) 1,0,0,14

Broadcasting Scheduling (Example)

AP1601N IP High Quality Audio Broadcasting Terminal

방송세션 이름	예약 방송 이름	예약 방송 종류	요일	시작 시간	종료 시간	설명
전체 오디오 방송	2교시 종료	월요일-금요일		10:50:00	10:50:15	
전체 오디오 방송	2교시 시작	월요일-금요일		10:00:00	10:00:15	
전체 오디오 방송	1교시 종료	월요일-금요일		09:50:00	09:50:15	
전체 오디오 방송	1교시 시작	월요일-금요일		09:00:00	09:00:15	
전체 오디오 방송	점심 방송	월요일-금요일		12:00:00	13:00:00	
전체 오디오 방송	아침 방송	월요일-금요일		07:30:00	08:30:00	
전체 오디오 방송	3교시 종료	월요일-금요일		11:50:00	11:50:15	
전체 오디오 방송	3교시 시작	월요일-금요일		11:00:00	11:00:15	

Event Log (Example)

AP1601N IP High Quality Audio Broadcasting Terminal

The screenshot displays the '이벤트 이력 조회' (Event History Query) window. The window title is '이벤트 이력 조회' and it contains a table of event logs. The table has the following columns: 일자&시간 (Date & Time), 이벤트 (Event), 동작 (Action), 방송종류 (Broadcast Type), 방송이름 (Broadcast Name), 장비종류 (Equipment Type), 장비이름 (Equipment Name), IP주소 (IP Address), 장비상태 (Equipment Status), and 예약방송이름 (Reserved Broadcast Name). The table contains multiple rows of data, including 'Request', 'Response', 'START', and 'STOP' events for 'UNICAST' broadcasts. The status 'Not Response' is visible for several entries.

일자&시간	이벤트	동작	방송종류	방송이름	장비종류	장비이름	IP주소	장비상태	예약방송이름
2006-05-08 14:43:33	Request	STOP	UNICAST	테스트 오디오 방송					
2006-05-08 14:43:05	Request	START	UNICAST	테스트 오디오 방송					
2006-05-08 14:43:03	Request	START	UNICAST	테스트 오디오 방송					
2006-05-08 14:42:56	Request	STOP	UNICAST	테스트 오디오 방송					
2006-05-08 14:42:49	Request	START	UNICAST	테스트 오디오 방송					
2006-05-08 14:42:48	Request	START	UNICAST	테스트 오디오 방송					
2006-05-08 14:42:48	Request	START	UNICAST	테스트 오디오 방송					
2006-05-08 14:42:48	Request	START	UNICAST	테스트 오디오 방송					
2006-05-08 14:42:47	Request	STOP	UNICAST	테스트 오디오 방송					
2006-05-08 14:42:46	Request	START	UNICAST	테스트 오디오 방송					
2006-05-08 14:42:46	Request	STOP	UNICAST	테스트 오디오 방송					
2006-05-08 14:07:19	Request	START	UNICAST	테스트 비디오 방송					
2006-05-08 14:07:17	Response	STOP	UNICAST	테스트 오디오 방송	PLAY	교실	172.16.19.1...	Not Response	
2006-05-08 14:07:17	Response	STOP	UNICAST	테스트 오디오 방송	SOURCE	방송실	172.16.7.55	Not Response	
2006-05-08 14:07:16	Request	STOP	UNICAST	테스트 오디오 방송					
2006-05-08 14:07:07	Response	START	UNICAST	테스트 오디오 방송	PLAY	교실	172.16.19.1...	Not Response	
2006-05-08 14:07:07	Response	START	UNICAST	테스트 오디오 방송	SOURCE	방송실	172.16.7.55	Not Response	
2006-05-08 14:07:06	Request	START	UNICAST	테스트 오디오 방송					
2006-05-08 14:05:09	Request	STOP	UNICAST	테스트 비디오 방송					
2006-05-08 13:57:05	Request	START	UNICAST	테스트 비디오 방송					

At the bottom of the window, there is a status bar showing: 2006-05-09 오후 12:16:56, 사용자: root (administrator), 1,0,0,14.

IP HQ Audio Broadcasting Solution

Audio Broadcasting Manager S/W	HQ Audio Broadcasting Server AP-ABS5000	Audio Broadcasting Router (Relay Server)	HQ Audio Broadcasting Terminal AP1601N	AMP. On/Off Power Switch Box AP-PSB
				
<p>Window based Audio Broadcasting Management Software.</p>	<p>Embedded Hardware based Audio Codec. Ten(10) HQ Audio Codec Module. G.711, etc, Audio Codec.</p>	<p>1:N Audio Broadcasting Router. Gigabit Ethernet Support</p>	<p>Embedded Hardware based Audio Terminal One(1) HQ Audio Codec Module. G.711, etc, Audio Codec.</p>	<p>AMP. Power ON/OFF Switch Box. Background Noise Remove at OFF-AIR</p>

Application Service (IP Broadcasting Service)

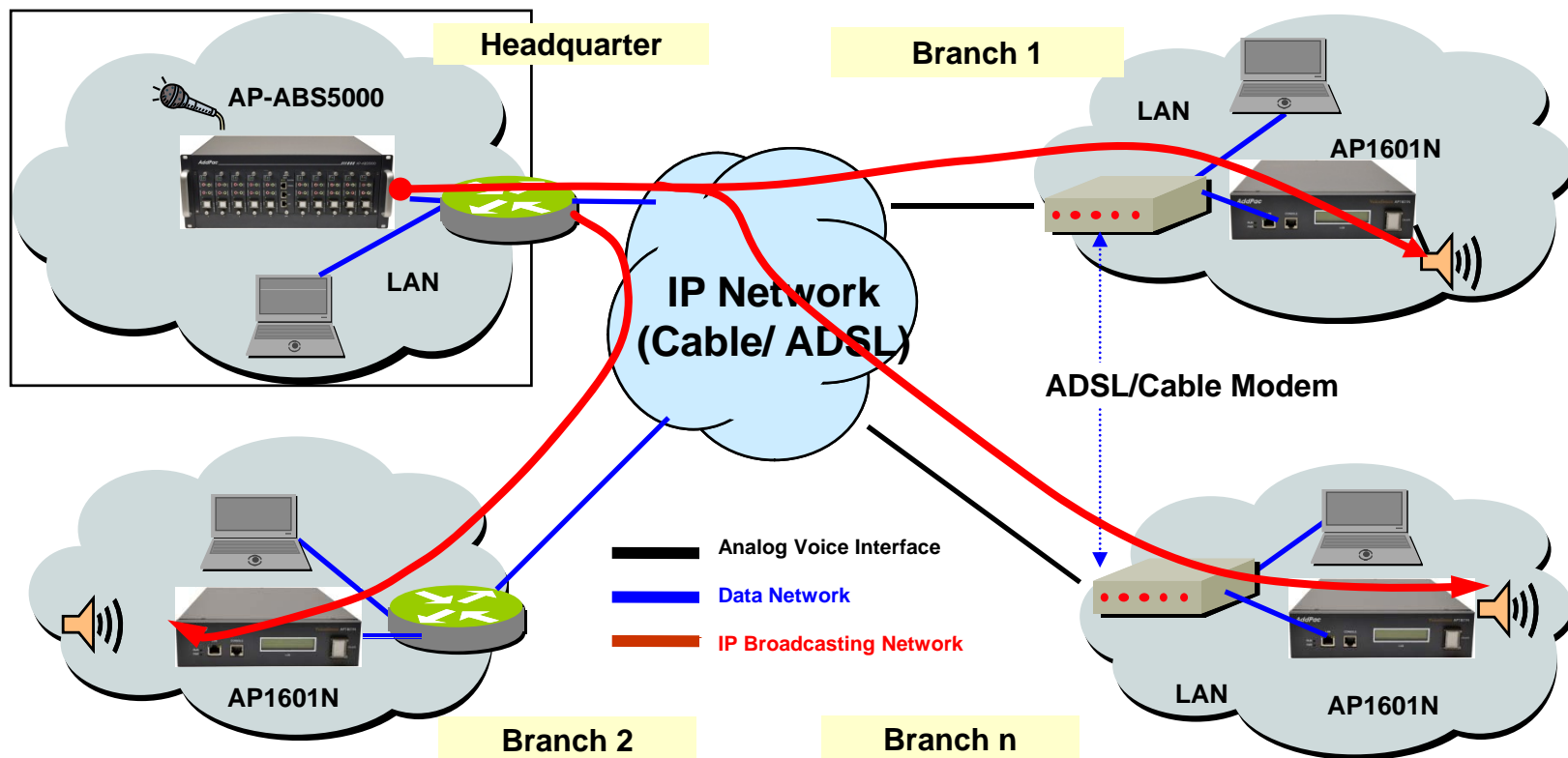

Ordering Information

- **AP1601N IP High Quality Audio Broadcasting Terminal Hardware**
 - AP1601N Main Body
 - RISC Microprocessor with High-end Programmable DSP Architecture
 - 1-ports 10/100Mbps Fast Ethernet and 1-port RJ45 RS-232C Console
 - One(1) AP-HQA1000 Module
 - Including Network Cable Set & Power Supply, etc.
- **Built-in APOS Internetworking Software for AP1601N**
- **Including 1 Year Hardware Warranty**
- **Product Documents**
 - Install and Operation Guide (PDF)
- **Pricing**
 - AddPac Technology Regional Sales Manager
 - Authorized Sales and Marketing Representatives
 - Please Contact www.addpac.com



Thank you!

AddPac Technology Co., Ltd.
Sales and Marketing

Phone +82.2.568.3848 (KOREA)

FAX +82.2.568.3847 (KOREA)

E-mail sales@addpac.com