



# AP2650PMG

## PTT Media Gateway

High Performance PTT Media Gateway Solution

## Product Overview



**AddPac**

**AddPac Technology**

Sales and Marketing

[www.addpac.com](http://www.addpac.com)

# Contents

- Product Overview
- APOS Technology
- Hardware Specification
- PTT Service over Circuit Switch Network
- LMR Service Examples
- RoIP System Message Flow Diagram
- PTT Media Gateway Message Flow Diagram
- VoIP (Voice over IP) Service
- Advanced QoS Features
- Network Protocols
- Network Management
- Security Management
- Application Service
- Ordering Information

# Product Overview

## AP2650PMG PTT Media Gateway

- PTT over IP Service Support
- Radio Systems(Motorola, etc) are Extended to Circuit Switch Network(PSTN, Cellular) via IP Network
- High Performance RISC & Programmable DSP Architecture
- Two(2) 10/100Mbps Fast Ethernet (IP Share ,etc)
- High Performance LAN-to-LAN Routing Capability
- Four(4) Module Slots for PTT Media Gateway Service
- VoIP Codec : G.711/G.726/G.723/G.729, VAD, etc
- Powerful Network Protocols (PPPoE, DHCP, Static Routing, etc)
- IPv4/IPv6 Dual Stack Support
- SIP/H.323 Dual Concurrent Signaling Protocols
- Firmware Upgradeable Architecture
- Advanced Voice QoS Mechanism
- Powerful Web based Management
- RS232C Port Support for Command Line Interface
- Dual Power Supply for Redundancy

# Product Highlights

## AP2650PMG PTT Media Gateway

### PTT Media Gateway Solution for Circuit Switch Network (PSTN, Cellular)

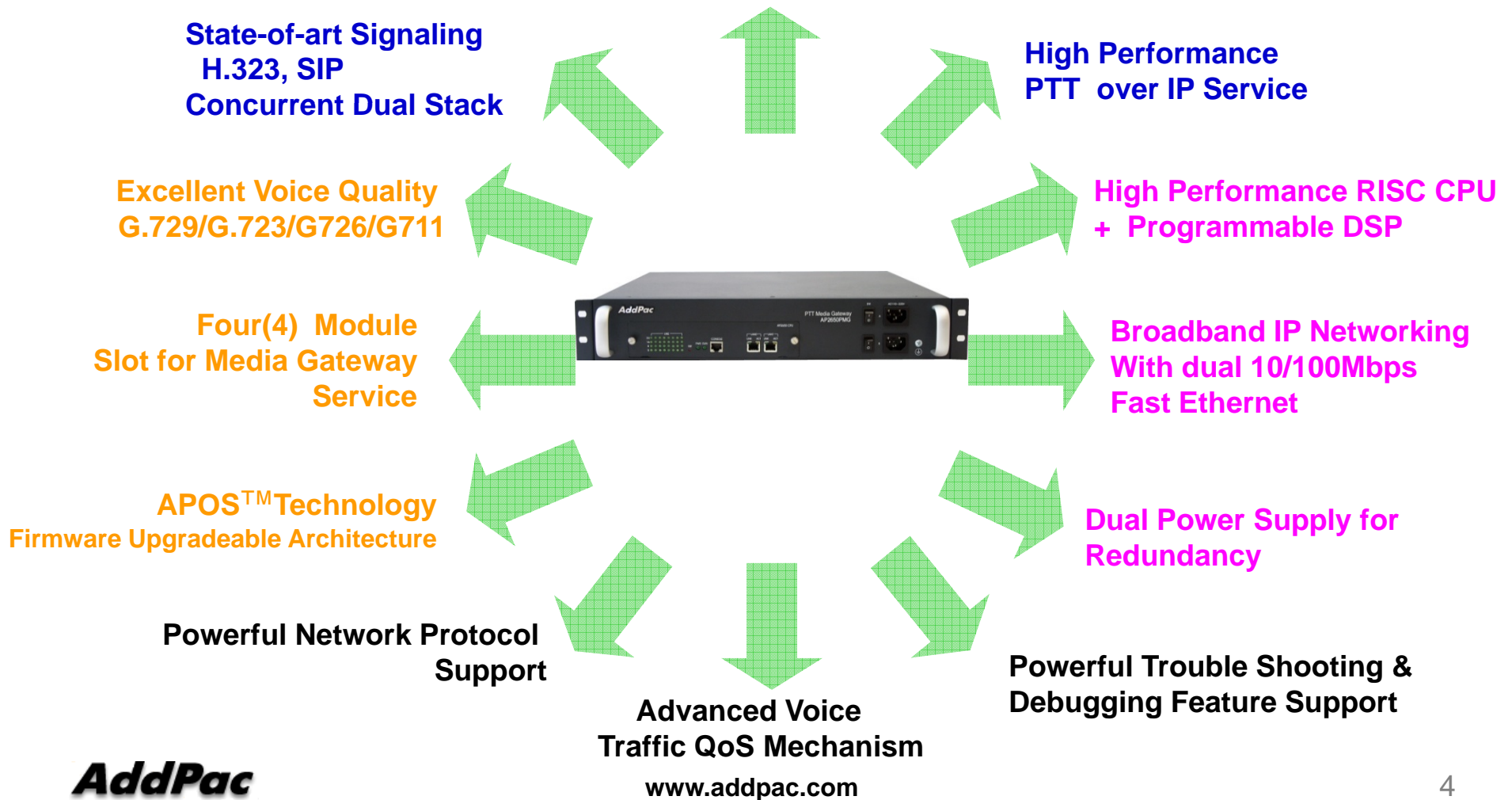

# APOS Technology

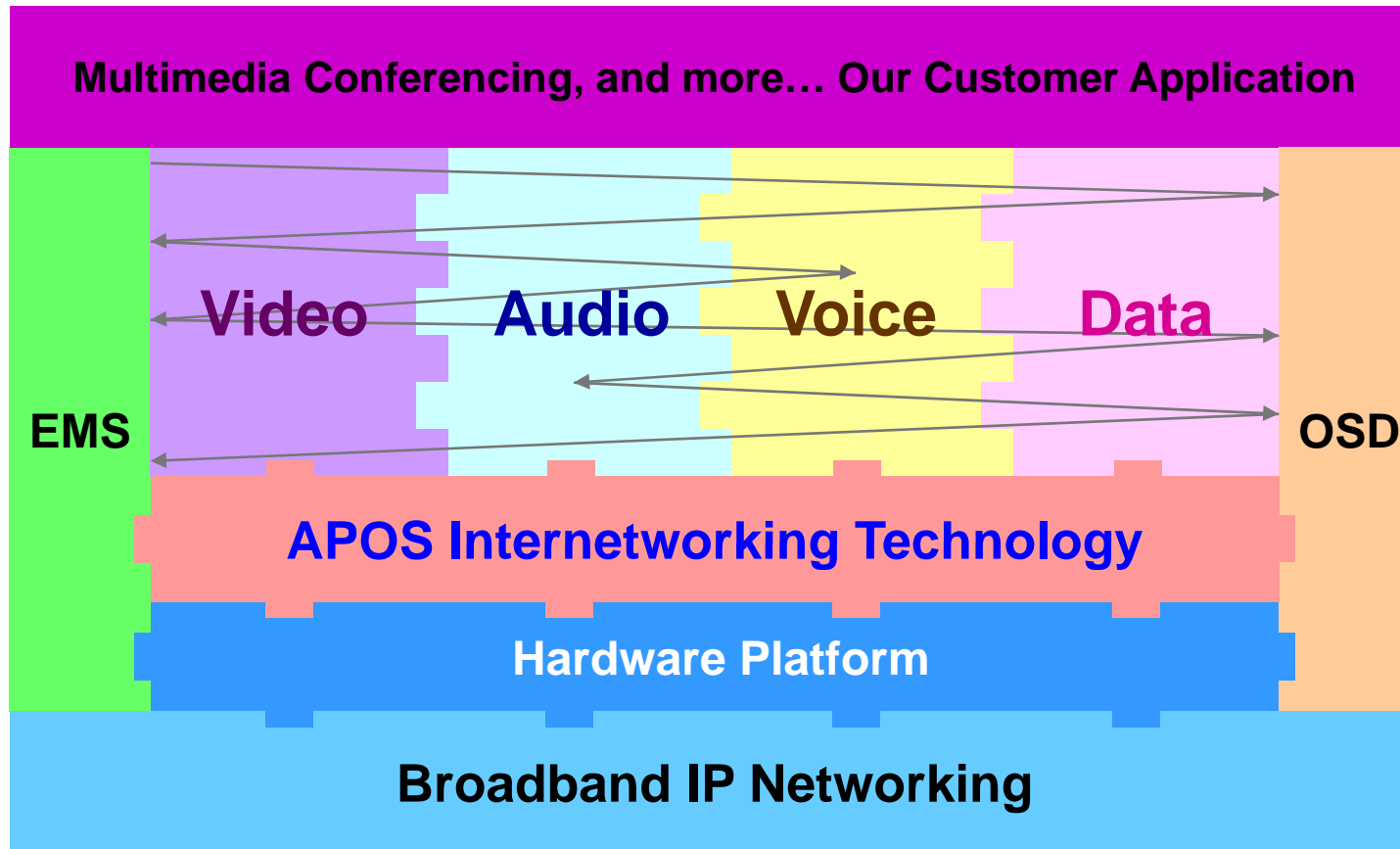

- APOS : AddPac Internetworking Operating System
- OSD : On- Screen Display
- EMS : Element Management System

# Hardware Specification

AP2650PMG PTT Media Gateway

RISC  
CPU

High-end  
DSP

- RISC Microprocessor Computing Power
- Main Chassis
  - Module Type System Processor Interface
    - Two(2) 10/100Mbps Fast Ethernet
    - One(1) RS-232C Console (RJ45)
  - Four(4) Module Slots for FXS, FXO, Digital E1/T1, etc
  - Dual Power Supply



RS232C  
Console Port

LAN0(10/100Mbps)

LAN1 (10/100Mbps)

Power Switch

Power Inlet

**AddPac**

[www.addpac.com](http://www.addpac.com)

# Hardware Specification





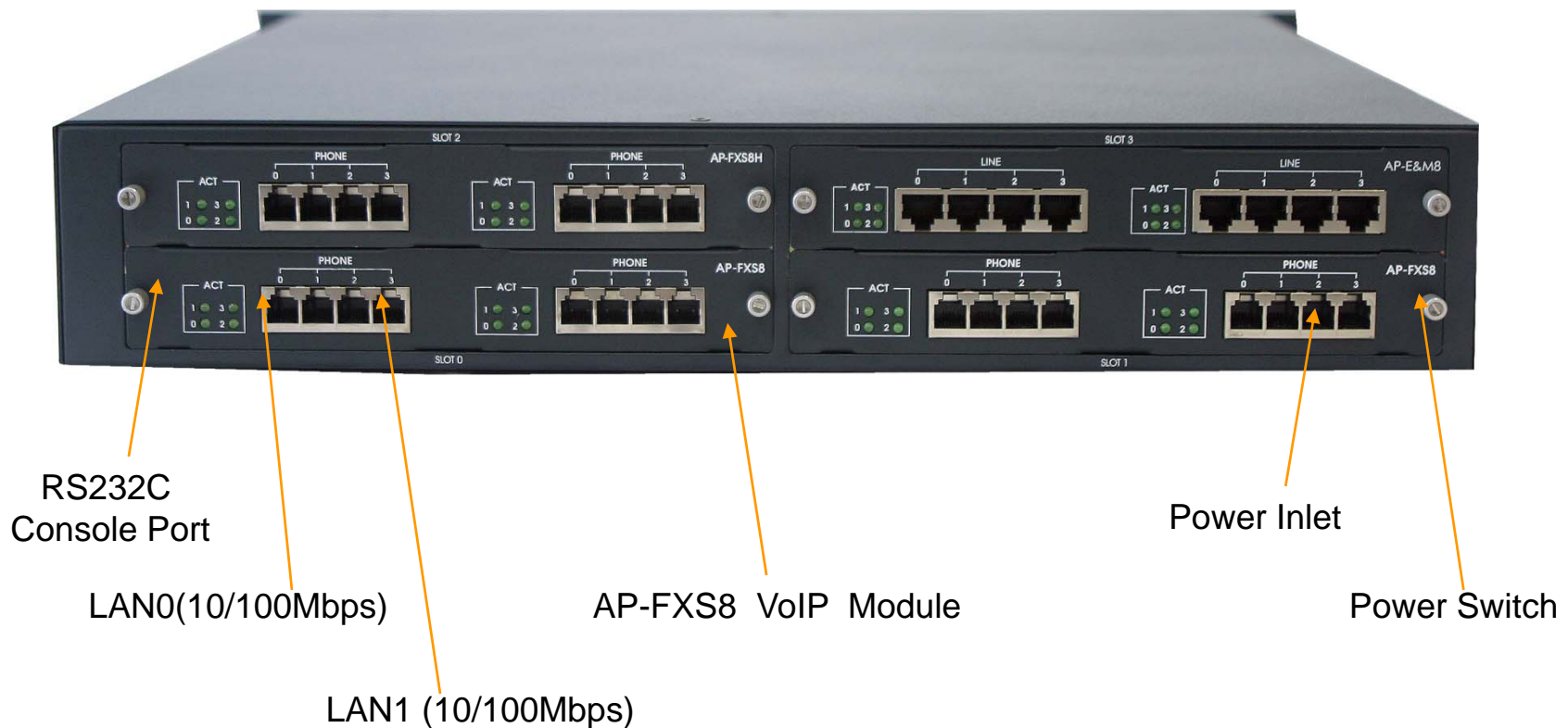

## AP2650PMG PTT Media Gateway

### AP2650PMG Back Side



# Hardware Specification

## AP2650PMG PTT Media Gateway

Target	VoIP Modules	Module Features	Module Picture
AP2120N AP2640 AP2650	<b>AP-FXS8</b>	8-Port FXS Module	
AP2120N AP2640 AP2650	<b>AP-FXO8</b>	8-Port FXS Module	
AP2120N AP2640 AP2650	<b>AP-FXS4O4</b>	4-Port FXS&4-Port FXO Module	
AP2120N AP2640 AP2650	<b>AP-E&amp;M8</b>	8-Port E&M Module	
AP2640 AP2650	<b>AP-E1</b>	1-Port Digital E1/T1 Module	
AP2640 AP2650	<b>AP-2E1</b>	2-Port Digital E1/T1 Module	



# PTT Service over Circuit Switch Network

## AP2650PMG PTT Media Gateway

- **AddPac PTT Service Solution Features**
  - PTT Media Gateway(AP2650PMG) joins the PSTN analog phones, Cellular Phones to the IP network through open SIP standard and RTP.
  - Analog phones, Cellular phones are connected to PTT media gateway through Circuit Switch Network such as PSTN, Cellular Network, etc.
  - AddPac IP PTT terminals (AP-IP230, AP-IP300 IP Phones, AP-WP100 WiFi-Phone, etc) support the traditional analog phone user interface(PTT).
  - AddPac IP PTT terminals easy PTT group management user interface.
  - IP-PBX support call management, PTT group management, PTT control and various additional service.
  - PTT Server(AP-PTS3000) support powerful media data relay, broadcasting, multicasting and PTT group management..

# LMR Service Examples

## AP2650PMG PTT Media Gateway

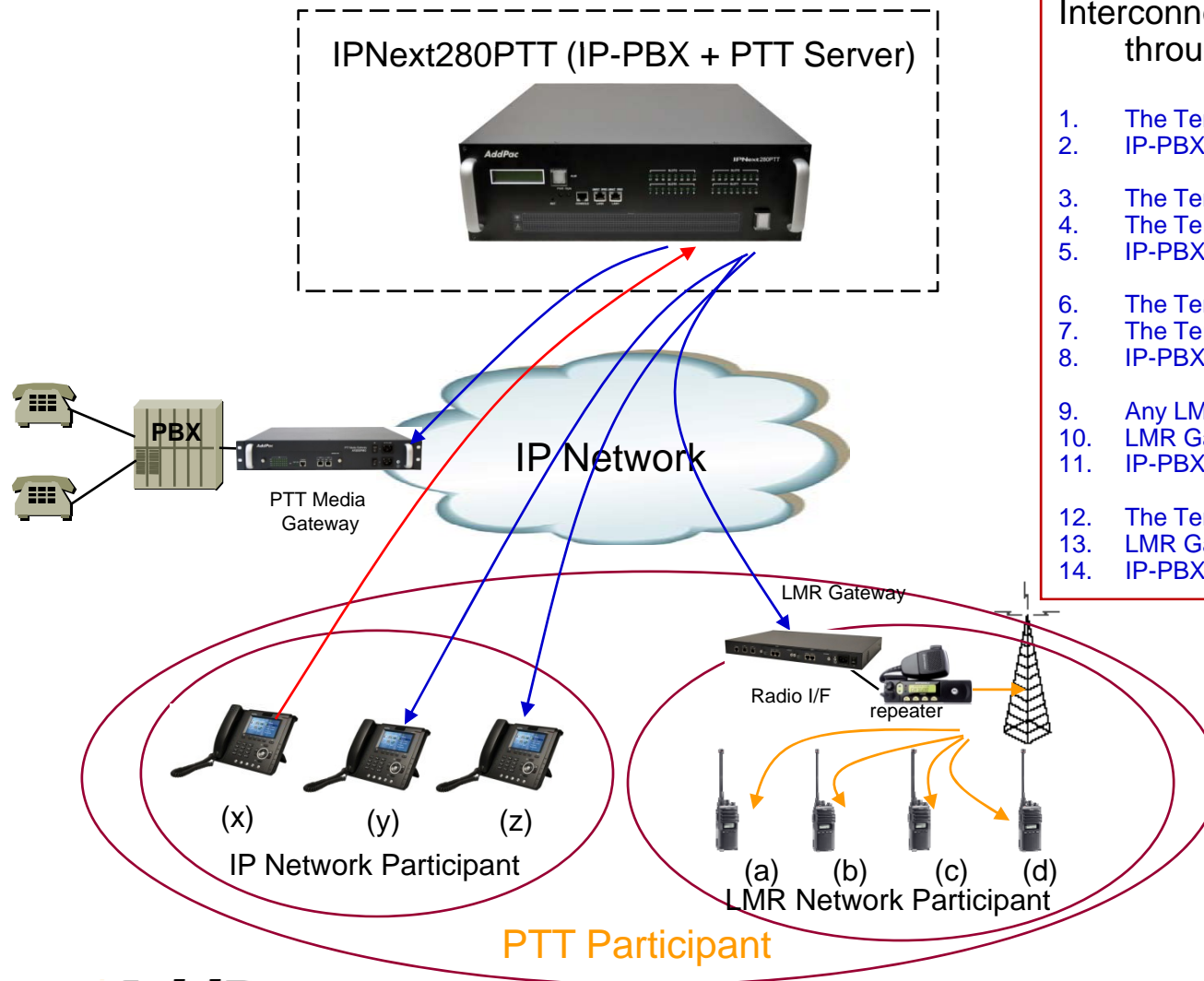

### Interconnection LMR systems to IP network through AddPac RoIP solution.

1. The Terminal(x) originate a PTT conference.
2. IP-PBX send invitation message to all participant.
3. The Terminal(x) presses the 'floor button' to talk.
4. The Terminal(x) send a 'floor-request' message.
5. IP-PBX and PTT servers control media-relay.
6. The Terminal(x) releases the 'floor button'.
7. The Terminal(x) send a 'release-request' message.
8. IP-PBX and PTT servers control media-relay.
9. Any LMR Terminal(a~d) presses the 'floor button' to talk.
10. LMR Gateway send a 'floor-request' message.
11. IP-PBX and PTT servers control media-relay.
12. The Terminal(a) releases the 'floor button'.
13. LMR Gateway send a 'release-request' message.
14. IP-PBX and PTT servers control media-relay.

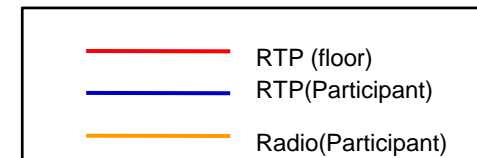

# RoIP System Message Flow

## AP2650PMG PTT Media Gateway

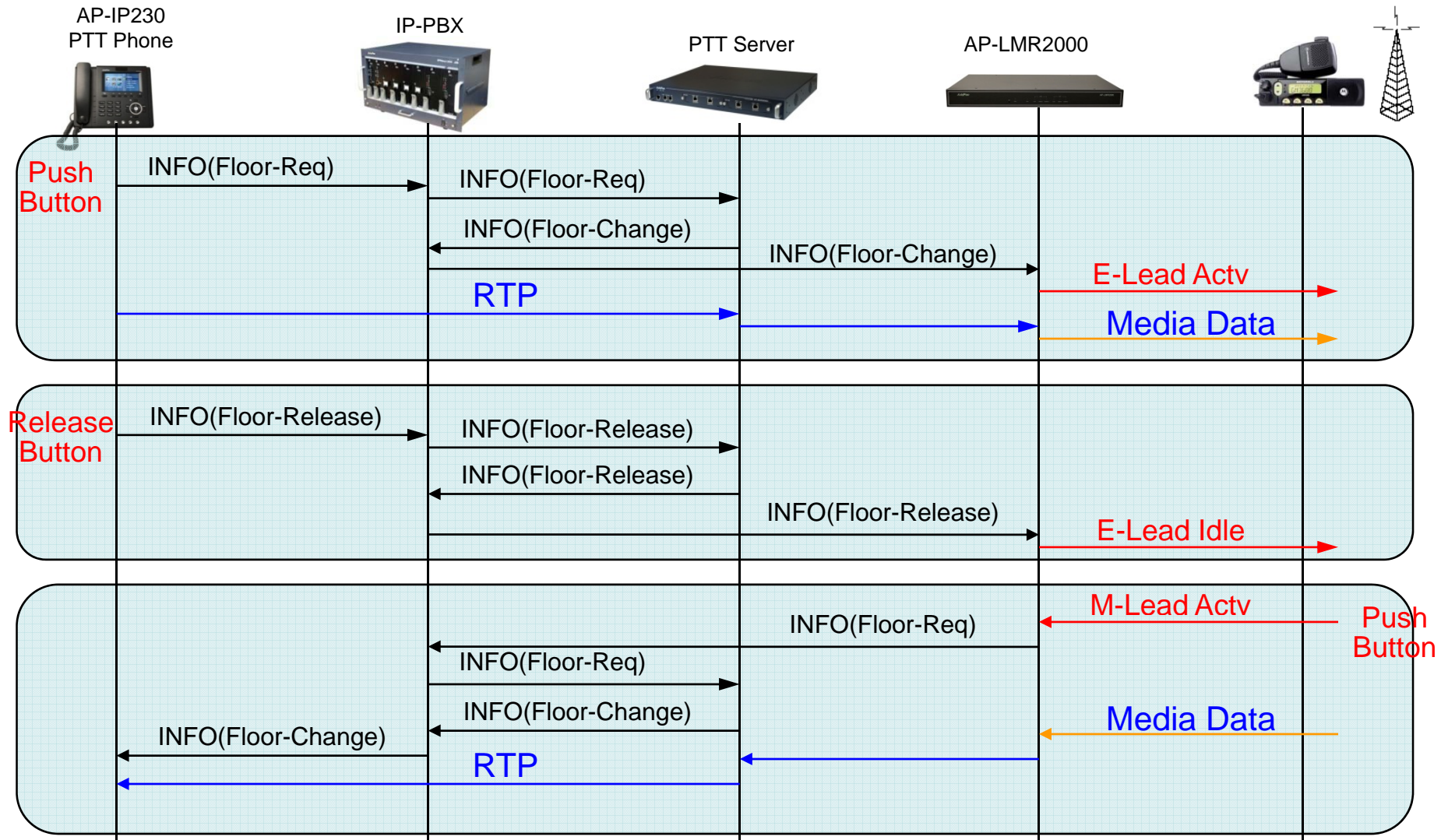

# PMG System Message Flow

## AP2650PMG PTT Media Gateway

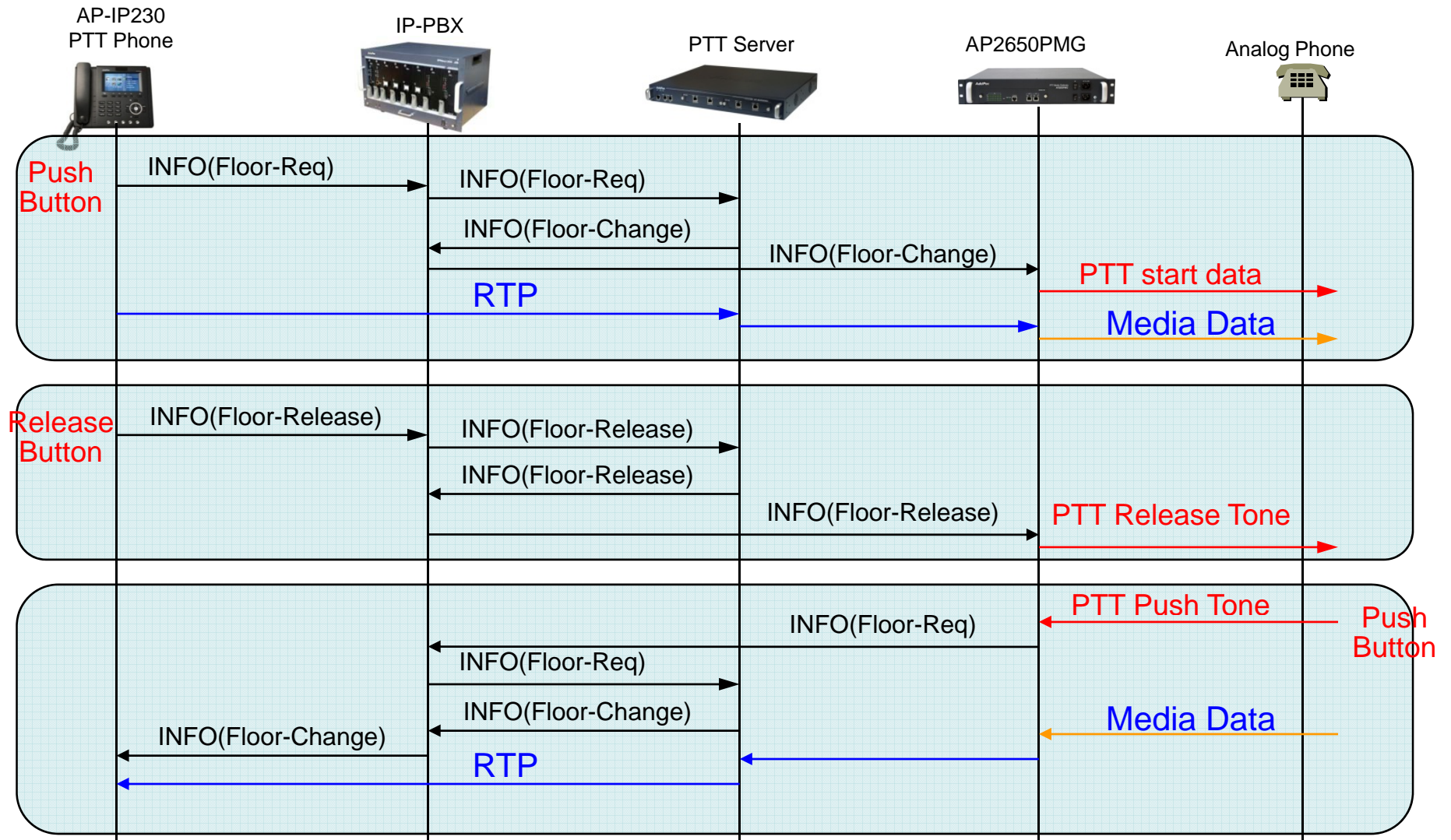

# VoIP (Voice over IP) Service

AP2650PMG PTT Media Gateway

- **H.323, SIP Dual Stack**
- **H.323**
  - ITU-T Standard H.323 v3 Support
  - Support H.245 Tunneling
  - Including H.235 Security Features
- **SIP**
  - IETF RFC3261 or RFC2543 SIP Standard

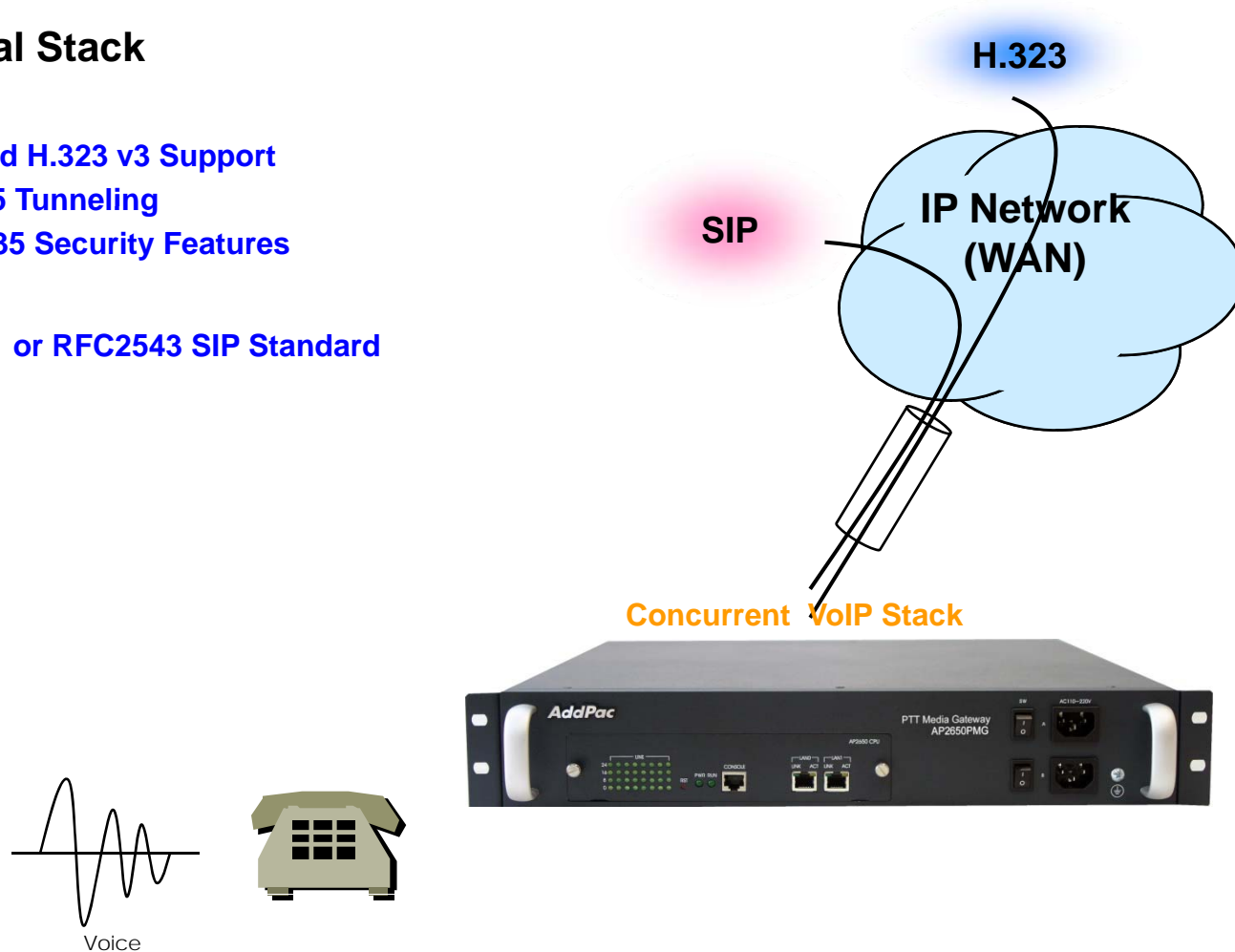

# VoIP (Voice over IP) Service

## AP2650PMG PTT Media Gateway

- **H.323**

- Fast connect, normal connect support
- H.245 tunneling support
- Q.931 response message setting for inbound VoIP calls
- H.245 logical channel open timing selection function
- Start H.245 procedure support
- DTMF / Hook flash relay with H.245 alphanumeric / signal
- Secondary gatekeeper support
- Gatekeeper assignment according to the domain name
- Gatekeeper discovery with multicast
- Lightweight RRQ support
- Signaling TCP port assignment
- Resource threshold setting with RAI
- H.235 clear-token, crypto-token support
- canMapAlias support
- Technical prefix (supported prefix) support
- Public IP assignment in NAT environment

- **SIP**

- Gateway-based / Endpoint-based registration support
- Secondary proxy-server assignment function
- SIP signaling port change function
- SIP proxy server assignment according to the domain name
- T.38 real-time fax relay support
- DTMF relay support with RFC2833 / OPTION message
- Re-INVITE support

# VoIP (Voice over IP) Service

## AP2650PMG PTT Media Gateway

- **Voice Codec**
  - G.711 A-Law, G.711 U-Law
  - G.726 r16, G.726 r32
  - G.729A
  - G.723.1 r63, G.723.1 r53
  - VAD (Voice Activity Detection) function support
  - DTMF relay support (H.323, SIP, MGCP common) based on RFC2833
- **RTP**
  - Redundant RTP packet transmission in case of severe packet loss
  - Dynamic jitter buffer management and RPT packet jitter and loss compensation with heuristic & DSP error concealment
  - Static jitter buffer setting support
  - Voice frame per RTP packet number control for each codec
  - In-band ring-back tone support
  - Virtual ring-back tone support
  - Tone parameter change support



# VoIP (Voice over IP) Service

## AP2650PMG PTT Media Gateway

### • VoIP Call Controls

- Hot line connection function with PLAR (Private Line Auto Ring Down)
- Leased line emulation function
- Connection monitoring function
- Fault tolerant with Redundancy and Call Distribution among Gateways for load balancing
- Call attempt with IP address
- H.323, SIP, MGCP inbound call connection for each voice port
- Multiple E.164 setting for one voice port
- One E.164 or digit pattern can be assigned to more than one voice port
- Hunting with Longest match/ priority/ sequence/ random
- One stage call setup by Digit forwarding
- Call barring with specific digit patterns
- Calling and called number conversion for PSTN outbound calls
- PSTN rerouting in case of VoIP call attempt failure

### • VoIP Call Controls (cont.)

- Call transfer for internal calls
- Call pickup for internal calls
- Calling and called number conversion for VoIP outbound calls
- Calling and called number conversion for VoIP inbound calls
- Fax broadcasting call control

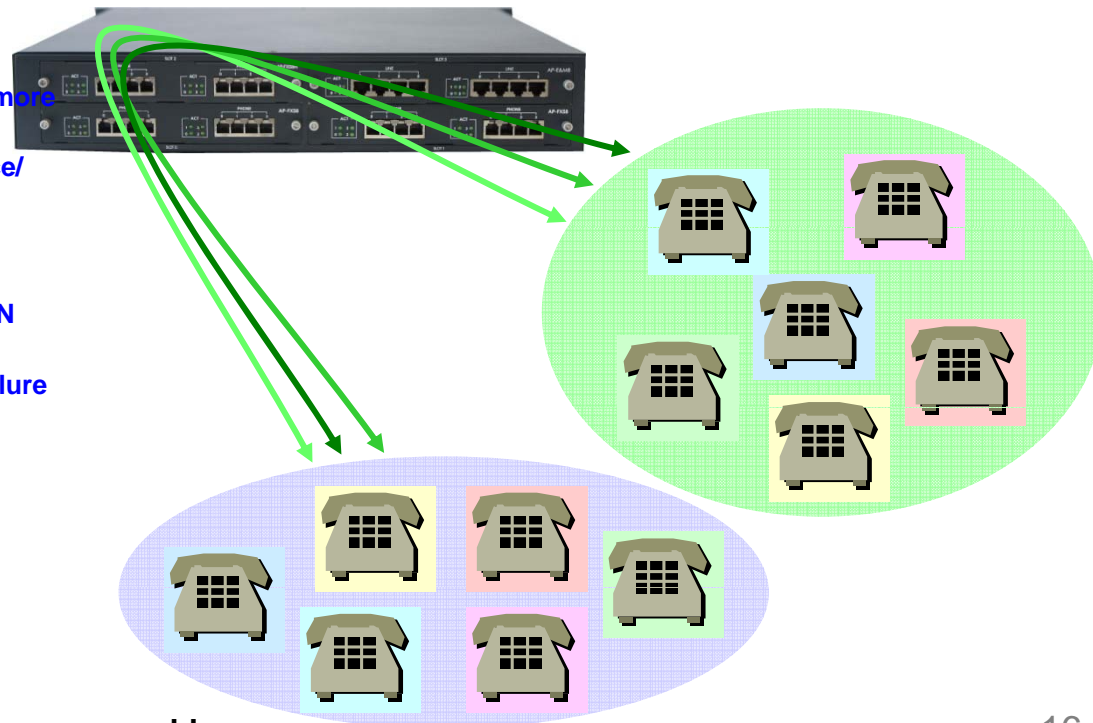



# Advanced QoS Features

## AP2650PMG PTT Media Gateway

- Enhances **Transmit** Voice QoS Features
  - Voice Traffic Priority Queuing
  - QoS Service Profiling
  - Providing Virtual Network Transmit Algorithm
  - Real-time Voice Traffic QoS Support
  - RTP Packet Transmit Interval Control
  - Supporting RTP Packet Redundancy Scheme
  - IP Header Control such as ToS, Diffserv
- Enhances **Receive** Voice QoS Features
  - Dynamic Jitter Buffer Management
  - Error Concealment
  - Support T.38 FAX Data Error Recovery Scheme

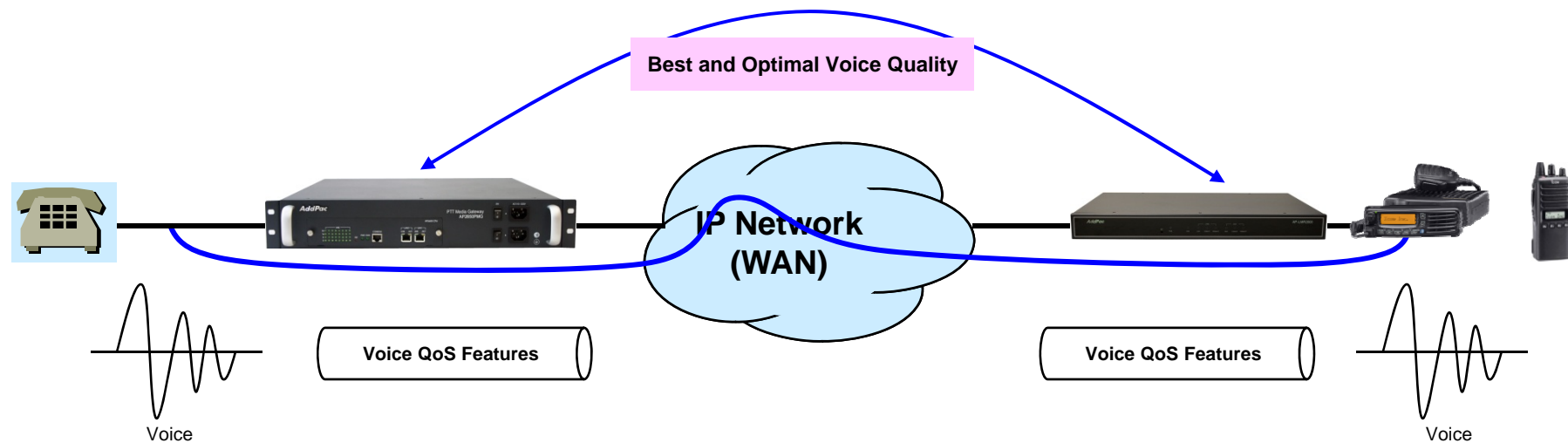

# Network Protocols

AP2650PMG PTT Media Gateway

## Basic Network Protocols

- ARP, IPv4, TCP, UDP, ICMP, SCTP, IGMP, MLD

## Routing Protocol

- IPv4 : Static

## Service Protocol

- FTP, Telnet, TFTP, DHCP Server/Relay, SNMP Server
- CDP (Cisco Discovery Protocol)
- DNS Resolver , DDNS(nsupdate)
- Bridge
- Syslog

## IPv4 Address Configuration

- Fixed (Static)
- DHCP
- PPPoE

## Miscellaneous

- Cisco Style CLI
- Standard & Extended IPv4 Access List
- Multi-level User Account Management
- IP accounting
- STUN Client

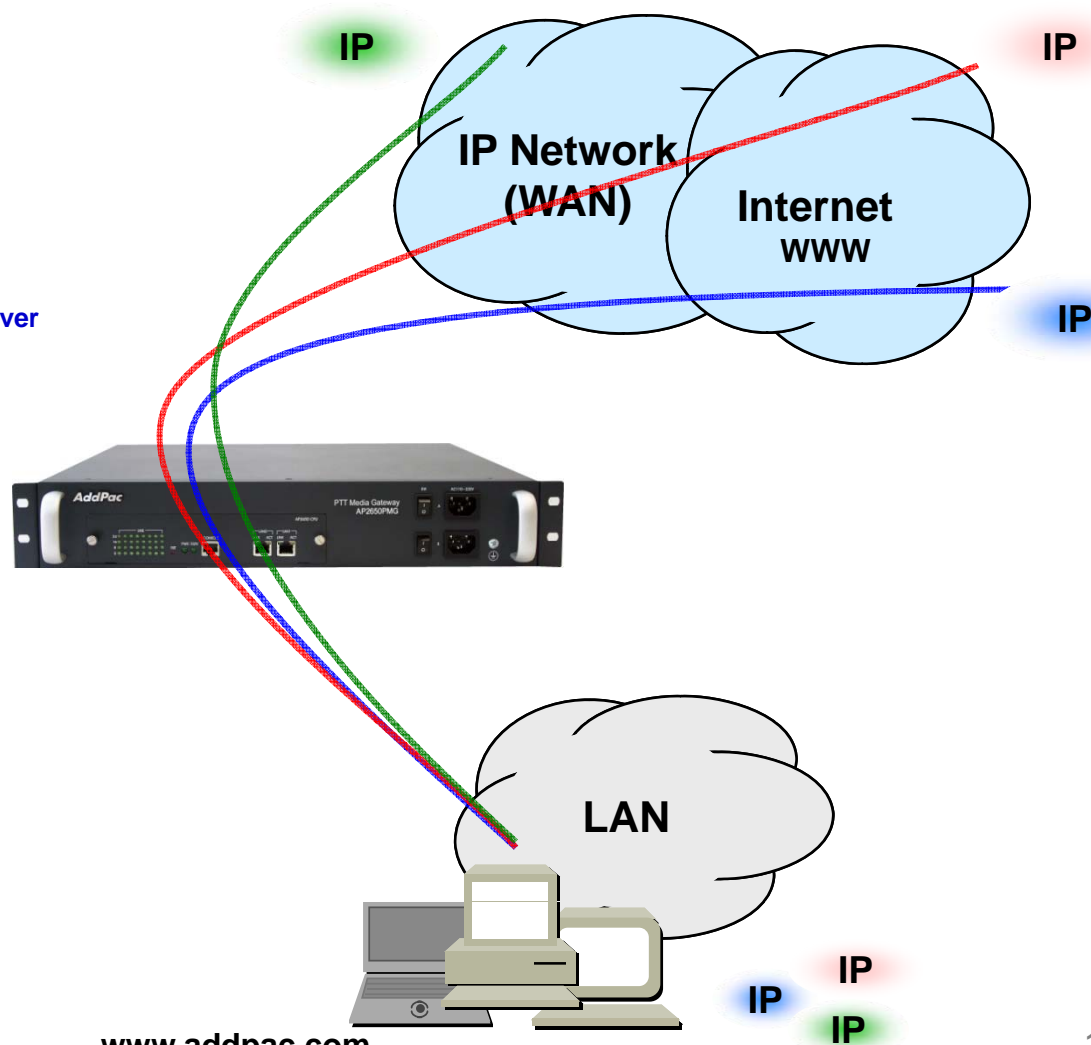

# Network Management

## AP2650PMG PTT Media Gateway

- **SNMP**

- Standard Simple Network Management Protocol( SNMP) Agent support
- MIB v1 and v2 Support

- **Web-based Management**

- Smart Easy Setup
- Standard Voice Interface
- Standard PSTN Back-up Interface

- **Watch-dog Function**

- Hardware, Software watch-dog services

- **Remote Management**

- Telnet
- Rlogin

- **Auto Upgrade Service**

- HTTP server based APOS image and configuration file auto-upgrade support

- **Batch Job Function**

- Text based script downloading

- **Interoperable with AP-VPMS Service**

- AddPac VoIP Plug & Play Management System (AP-VPMS)

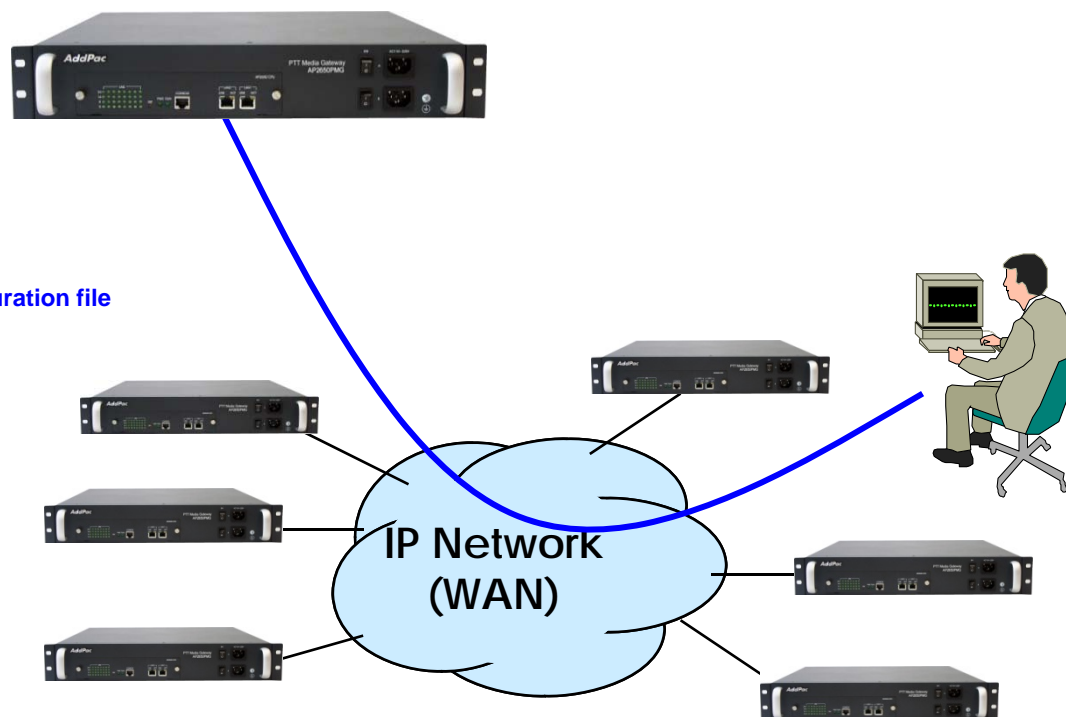

# Security Management

## AP2650PMG PTT Media Gateway

- IP packet filtering
- IP access list
- User authentication function
  - Password Authentication Protocol (PAP)
  - Challenge Handshake Authentication Protocol (CHAP)
- Enable/Disable specific protocols
- Auto-square connect of Telnet session
- Account Management function for multi-level user
- SNMP/TELNET/FTP/HTTP/TFTP port assignment function
- SNMP/TELNET/FTP access list management
- Boot mode security checking function

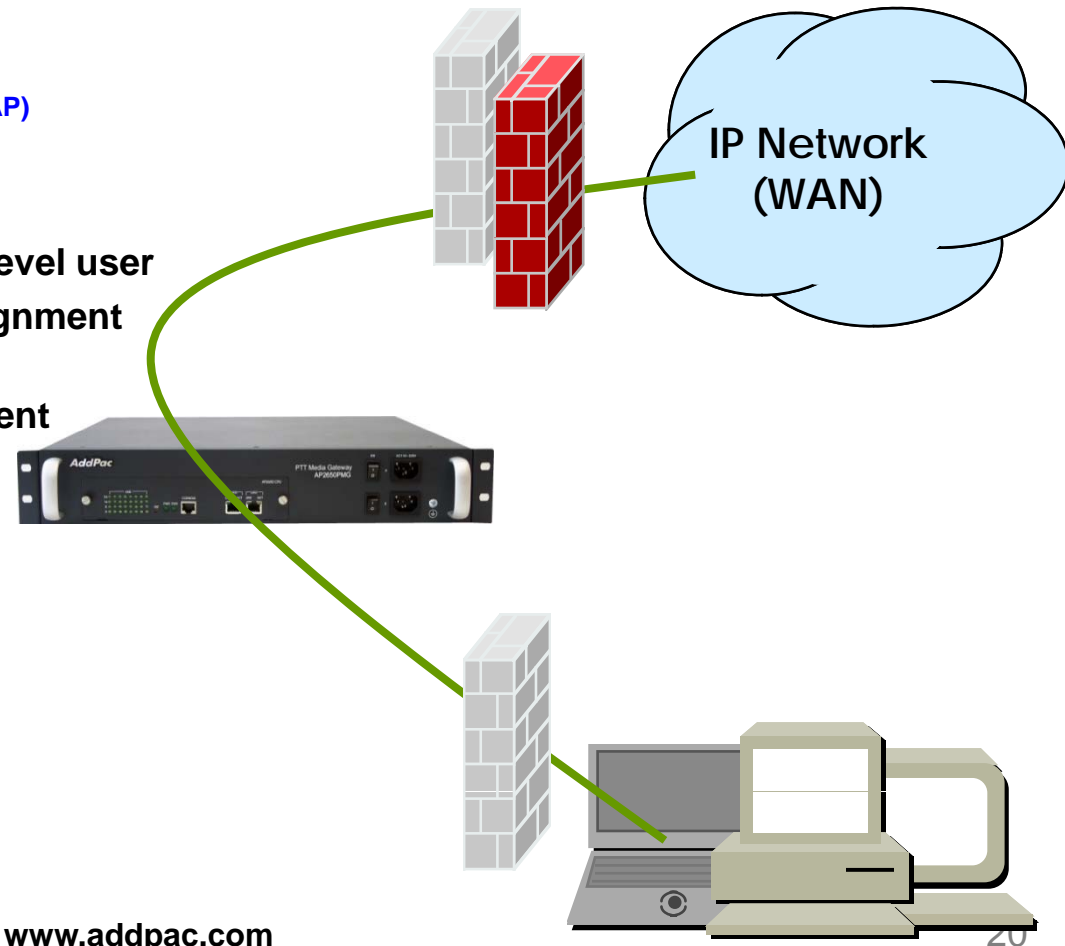

# Standard Application

## AP2650PMG PTT Media Gateway

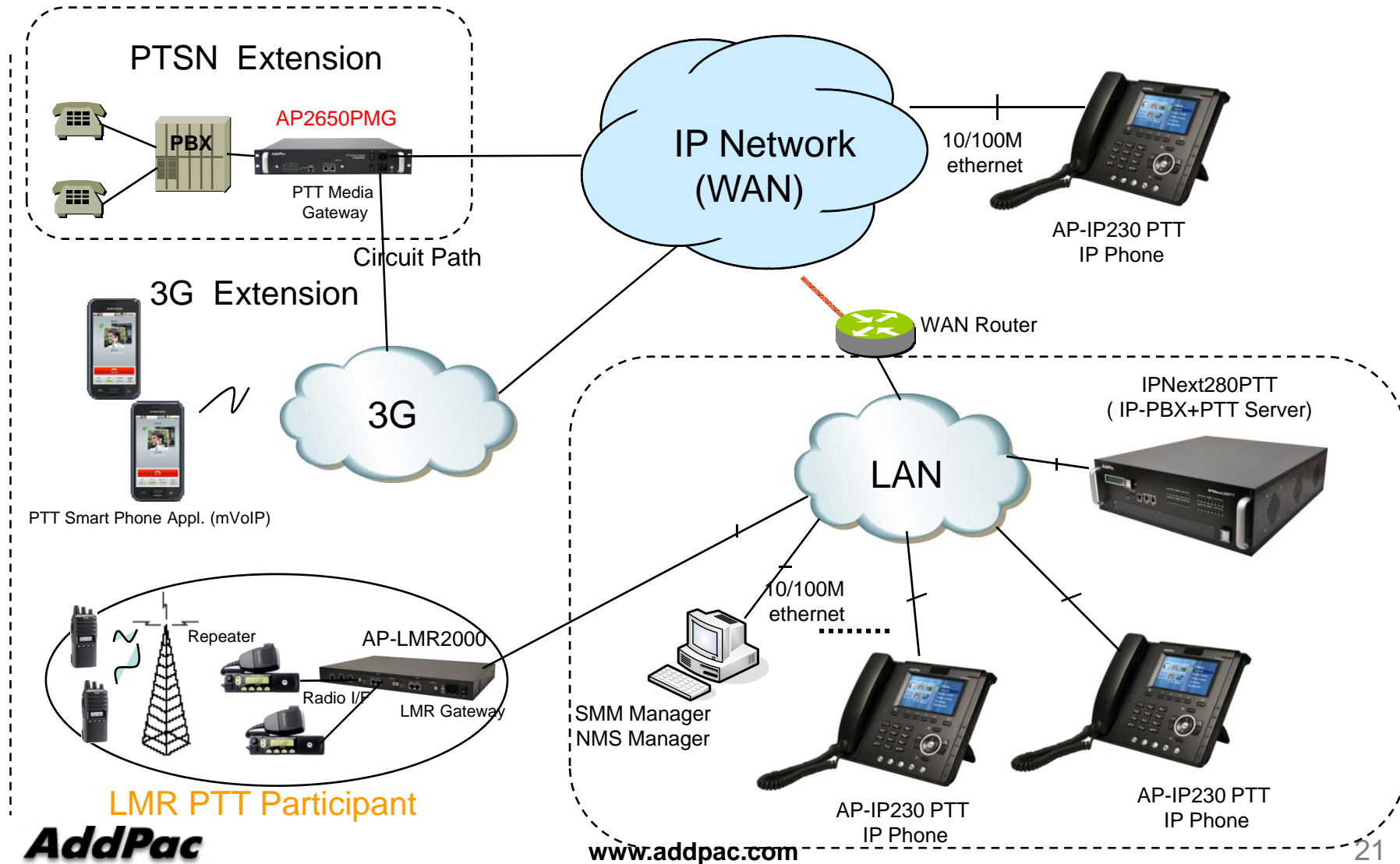

# Ordering Information

- **AP2650PMG PTT Media Gateway Hardware**
  - AP2650 Main Body
  - RISC Microprocessor with High-end Programmable DSP Architecture
  - Four(4) Module Slots for Media Interface
  - 2-ports 10/100Mbps Fast Ethernet(RJ45)
  - Option Module: AP-FXS8, AP-FXO8, AP-E1/T1, etc
  - Including Network Cable & Ext. Power Supply, etc.
- **Built-in APOS Internetworking Software for AP2650PMG**
- **Including 1 Year Hardware Warranty**
- **Product Documents**
  - Install and Operation Guide (PDF)
- **Pricing**
  - AddPac Technology Regional Sales Manager
  - Authorized Sales and Marketing Representatives
  - Please Contact [www.addpac.com](http://www.addpac.com)



# Thank you!

**AddPac Technology Co., Ltd.**  
Sales and Marketing

Phone +82.2.568.3848 (KOREA)

FAX +82.2.568.3847 (KOREA)

E-mail [sales@addpac.com](mailto:sales@addpac.com)