

# AP-GS2000

# GSM Gateway

## High Performance GSM Gateway Solution

ITPP (IP multimedia Telephony Provision Platform)



# **AddPac**

## AddPac Technology

### Sales and Marketing

[www.addpac.com](http://www.addpac.com)

# IP Multimedia Telephony Provision Platform

- Product Overview
- IP Telephony Network Diagram
- Product Specifications



AP-MC2000  
Audio/Video MCU



AP-VP300  
Video Phone



AP1800  
VoIP Gateway



AP-GS2000  
GSM Gateway



AP-IP300  
IP Phone



IPNext600  
IP-PBX



AP-TC1000 Traffic Controller

# Product Overview

- IP based Multimedia Telephony Total Solution
- IPv4/IPv6 Address Support
- High-performance Video, Audio, and Voice Service
- High-Performance A/V Mixing using External MCU
- Resource Management for WAN Access
- H.263, MPEG4, H.264, JPEG Codec Support
- SIP, H.323 V<sup>2</sup>oIP Signaling Support
- Firmware Upgradeable Architecture
- Video Solution with Outstanding Network Service Capability
- Management Software for IP Multimedia Telephony Solution

# Network Diagram (Case 1)

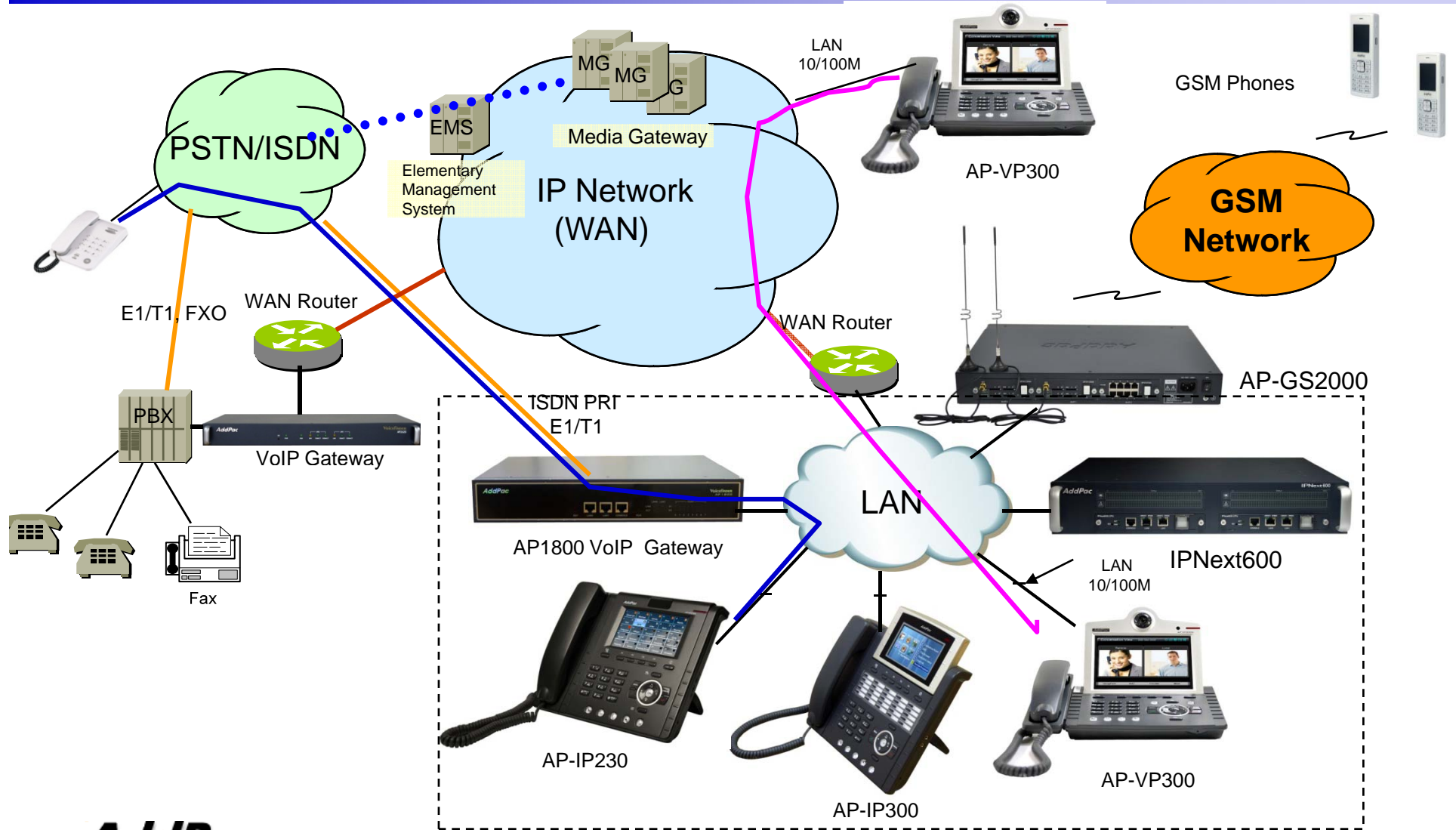

# Network Diagram (Case 2)

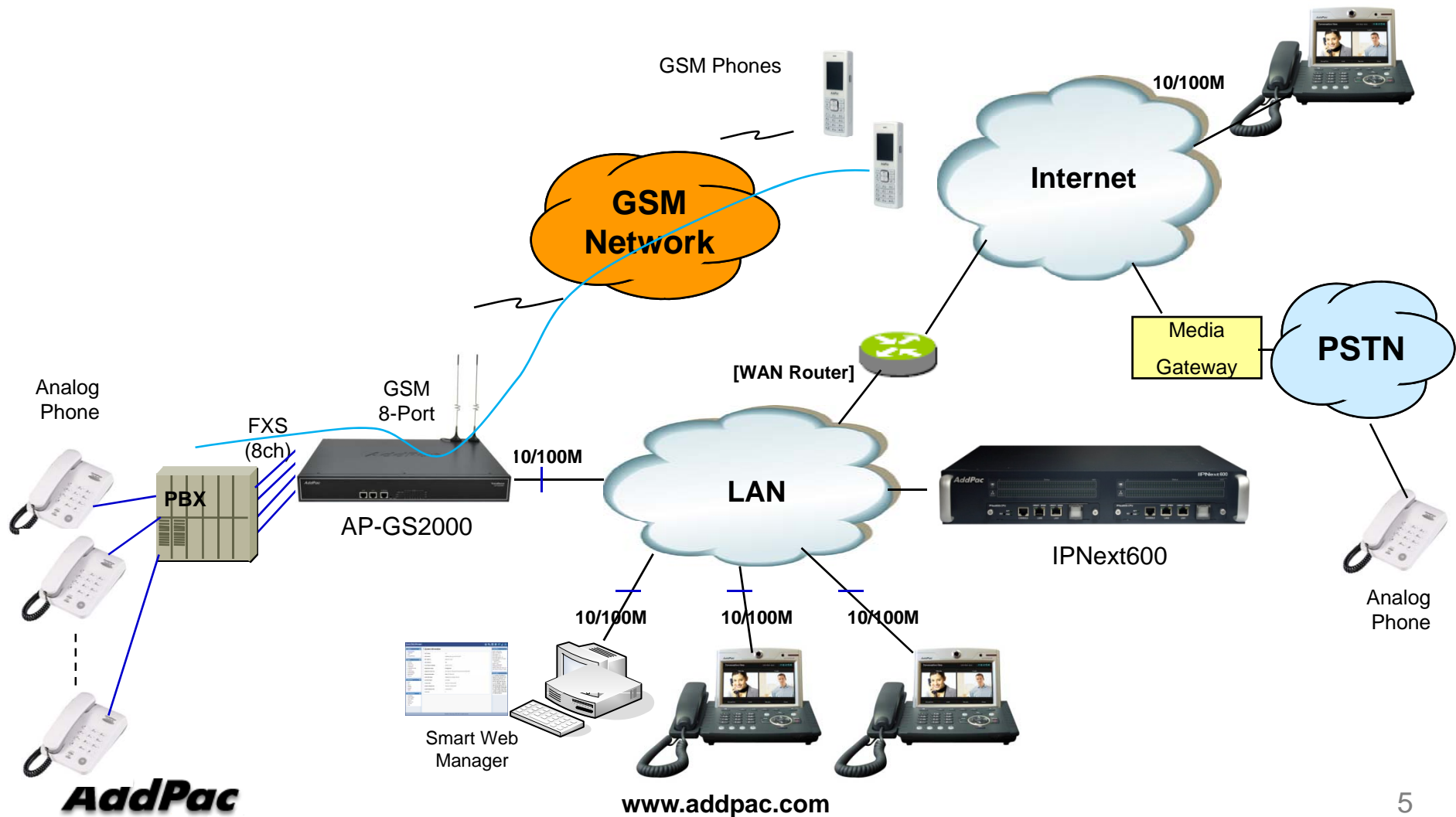

# Network Diagram (Case 3)

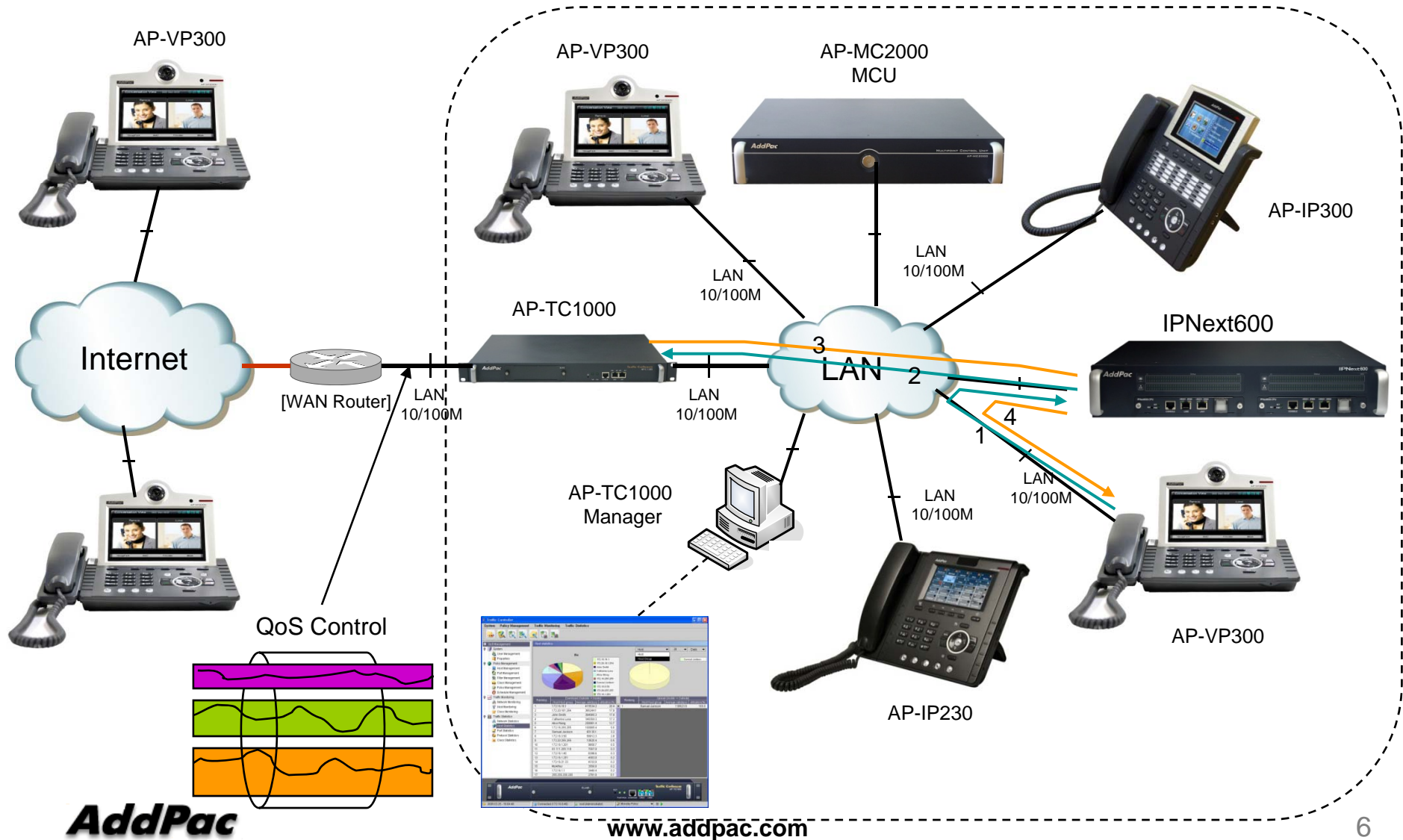



# Product Specification

# IPNext600 IP-PBX

- SIP Application Server, Proxy, Registrar and Location Server
- Multiple ITSP Trunk with SIP & H.323 Accounts Support
- Dual System Redundancy Architecture
  - Two(2) Fast Ethernet Interface / System
- High Performance RISC Architecture
- Powerful Network Protocols (PPPoE, DHCP, Static Routing, etc)
- IPv4/IPv6 Dual Stack
- RTP Proxy Function Embedded for Private IP and IPv6 Address Interworking
- User Presence Service Features for Smart Multimedia Messenger and Smart IP Phone
- IVR Scenario Editor, Voice Mail, Media Service (Coloring), Conference
- Firmware Upgradeable Architecture
- Smart Multimedia Manager for IP-PBX Management
- Smart Messenger Service (click to dial) for Unified Communication
- VPMS (VoIP Plug&Play Management System) & Smart NMS for Large Scale Deployment
- Advanced Voice QoS Mechanism
- Dual Redundancy Power Module





# AP-MC2000 Video MCU

- IP based Multipoint Audio/Video Mixing Solution
- Up to 16 Party Video Mixing
- H.264, MPEG4, H.263 Video Codec Support
- SIP/H.323 VoIP Signaling
- Support Various Conference System Model
- Scalability and Flexibility
- High-performance Video, Audio, and Voice Service
- Firmware Upgradeable Architecture
- Video Solution with Outstanding Network Service Capability
- Audio/Video Privacy Protection

# AP-TC1000 Traffic Controller

- Embedded Platform & Rack Type
- High-End RISC Processor
- Two(2)Independent Fast Ethernet Interface
- One(1) Network Interface Module Slot for WAN Access
- LAN-to-LAN QoS Routing
- Support Various QoS Algorithm & Police
- Powerful Management and User Friendly Features
- Graphical QoS Manager
- CLI Interface for Detailed Control
- Firmware Upgradeable Architecture

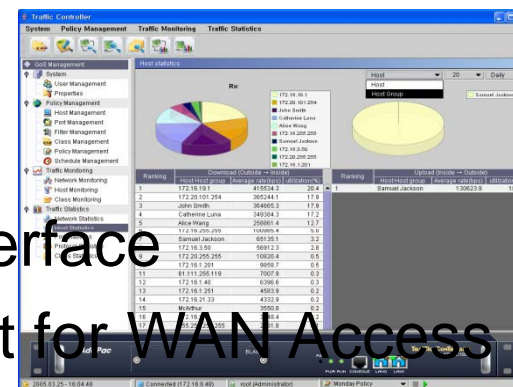

# AP1800 VoIP Gateway









- H.323/SIP/MGCP Triple Concurrent Stack Embedded
- High Performance RISC & Programmable DSP Architecture
- Two(2) 10/100Mbps Fast Ethernet (IP Share ,etc)
- High Performance LAN-to-LAN Routing Capability
- G.711/G.726/G.723/G.729, T.38 Fax , VAD, etc
- Powerful Network Protocols (PPPoE, DHCP, Static Routing, etc)
- Firmware Upgradeable Architecture
- VPMS (VoIP Plug&Play Management System) for Large Scale Deployment
- Advanced Voice QoS Mechanism
- Light and Compact Design with Internal Power Supply
- Two(2) VoIP Module Slot





# AP-GS2000 GSM Gateway

- Three(3) Module Slots for 4-Port GSM Module, 8FXS/8FXO Analog Interface (Up to 8-Port GSM +8FXS/8FXO Module, 12-Port GSM)
- H.323/SIP/MGCP Triple Concurrent Stack Embedded
- High Performance RISC & Programmable DSP Architecture
- G.711/G.726/G.723/G.729, T.38 Fax , VAD, etc
- Powerful Network Protocols (PPPoE, DHCP, Static Routing, etc)
- Two(2)10/100Mbps Fast Ethernet
- One(1) RS-232C Port for Command Line Interface
- Firmware Upgradeable Architecture
- VPMS (VoIP Plug&Play Management System) for Large Scale Deployment
- Advanced Voice QoS Mechanism
- Rack Mountable Chassis with Internal Power Supply

# IP Video Phone Comparison Table

	AP-VP500	AP-VP350	AP-VP300N	AP-VP280	AP-VP250	AP-VP230	AP-VP150	AP-VP120
								
LCD Size	12.1 Inch Touch Screen	7Inch Touch Screen	7Inch Touch Screen	7Inch Touch Screen	4.3Inch Touch Screen	5Inch Touch Screen	4.3Inch Touch Screen	4.3Inch
Camera	CCD	CCD	CCD	CMOS	CMOS	CMOS	CCD	CMOS
Video Codec	H.263 MPEG4 H.264	H.263 MPEG4 H.264	H.263 MPEG4 H.264	H.263 MPEG4 H.264	H.263 MPEG4 H.264	H.263 MPEG4 H.264	H.263 MPEG4 H.264	H.263 MPEG4 H.264
Signaling	H.323/SIP	H.323/SIP	H.323/SIP	H.323/SIP	H.323/SIP	H.323/SIP	H.323/SIP	H.323/SIP
Video MCU	N/A	4-Party Video MCU	N/A	N/A	N/A	N/A	N/A	N/A
Voice MCU	3-Party	3-Party	3-Party	3-Party	3-Party	3-Party	3-Party	3-Party
LAN Port	2	2	2	2	2	2	2	2
PoE	N/A	N/A	Support	N/A	Support	Support	Support	Support

# IP Phone Comparison Table

	AP-IP300 	AP-IP250 	AP-IP230 	AP-IP160 	AP-IP120 	AP-IP90 
LCD Size	4.3 Inch Color LCD	4.3 Inch Color LCD	5 Inch Color LCD	4 Text Line Graphic LCD	4 Text Line Graphic LCD	4 Text Line Graphic LCD
Touch Screen	N/A	Support	Support	N/A	N/A	N/A
Speed-Dial Keys	25 Key with Presence LED	Touch Screen based 25 Keys	Touch Screen based 25 Keys	16 Key with Presence LED	12 Key with Presence LED	N/A
Voice Codec	G.711/G.726/ G.729/G.723	G.711/G.726/ G.729/G.723	G.711/G.726/ G.729/G.723	G.711/G.726/ G.729/G.723	G.711/G.726/ G.729/G.723	G.711/G.726/ G.729/G.723
Signaling	H.323/SIP	H.323/SIP	H.323/SIP	H.323/SIP	H.323/SIP	H.323/SIP
3-Party Conversation	Support	Support	Support	Support	Support	Support
LAN Port	2	2	2	2	2	2
PoE(Optional)	Support	Support	Support	Support	Support	Support
FXO(Optional)	Support	Support	Support	Support	Support	Support



# Thank you!

**AddPac Technology Co., Ltd.**  
Sales and Marketing

Phone +82.2.568.3848 (KOREA)

FAX +82.2.568.3847 (KOREA)

E-mail [sales@addpac.com](mailto:sales@addpac.com)