

# IPNext187

## NGN Hybrid IP-PBX System

High-performance Next Generation Hybrid IP-PBX System

### Preliminary Product Overview



**AddPac**

**AddPac Technology**

Sales and Marketing

[www.addpac.com](http://www.addpac.com)

# Contents

- Product Overview
- Hardware Specification
- Software Service
- Hybrid IP-PBX Service and Features
- RTP Proxy Service
- User Presence Service
- Network Service and Features
- User Terminals
- Application Area
- Ordering Information

# Product Overview

## IPNext187 Next Generation Hybrid IP-PBX System

- IP based Advanced Hybrid IP-PBX Solution
- IPv4/IPv6 Multimedia Telephony Solution for Small Office
- PSTN Interface (FXO, FXS, E1/T1) Support
- Powerful Management and User Friendly Features
- Fault Tolerant and Scalability Architecture
- High-performance Video, Audio, and Voice Service
- Firmware Upgradeable Architecture
- IVR Service with Scenario Editor
- Voice Mailing Service
- Presence Service for High-End IP Key Phone, UC
- RTP Proxy Service for Private IP service
- SIP, H.323 Signaling for Outbound Calls
- Various Call Scenario (Call Pickup, Call Park, Call Transfer, etc)
- Various IP Terminal Support

# Product Highlights

IPNext187 Next Generation Hybrid IP-PBX System

## IP based Advanced Hybrid IP-PBX System

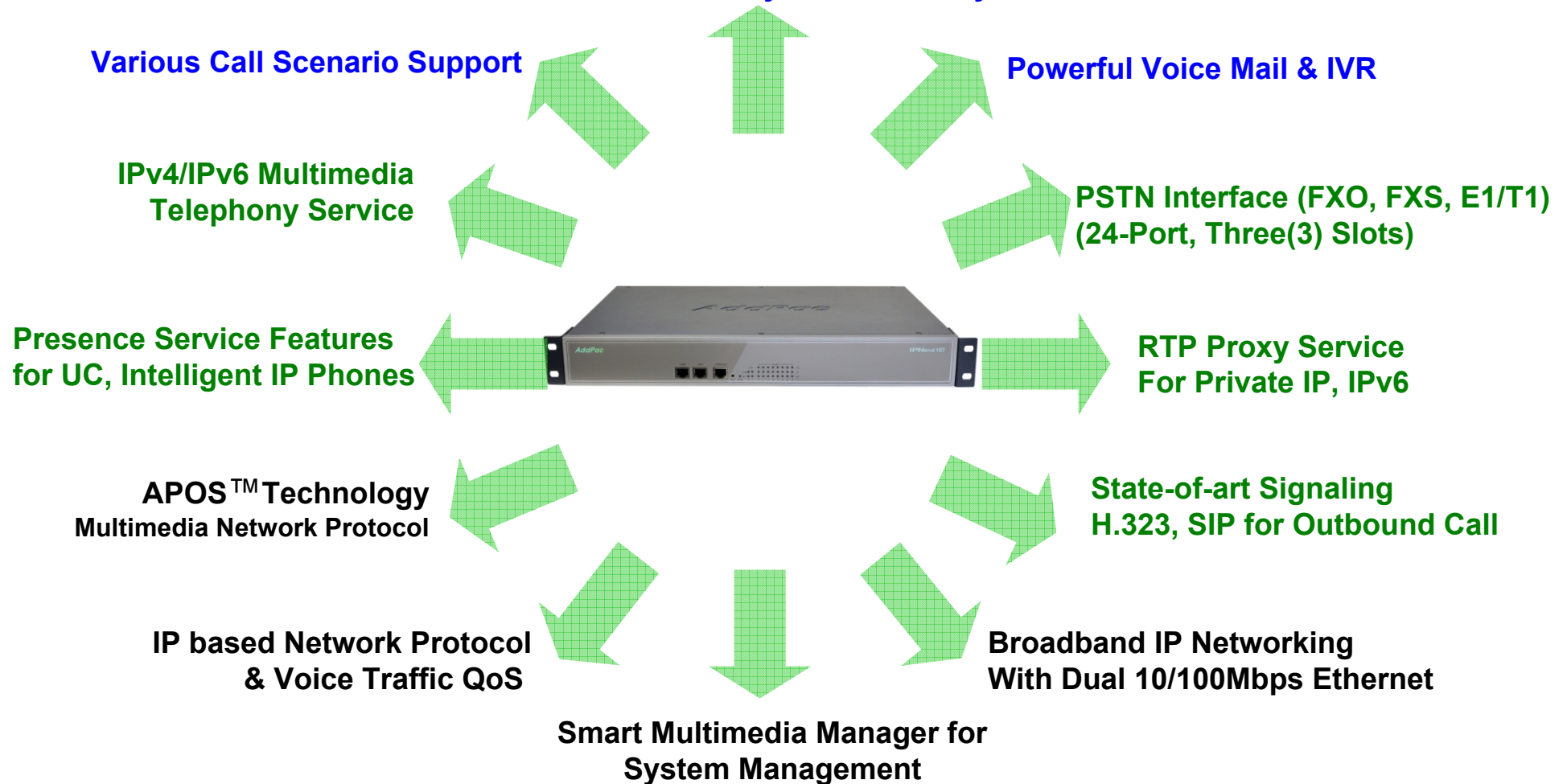

**AddPac**

[www.addpac.com](http://www.addpac.com)

# Hardware Specification

IPNext187 Next Generation Hybrid IP-PBX System

64bit  
CPU

- **RISC Microprocessor Computing Power**
- **Main Chassis**
  - **Network Interface**
    - Two(2) 10/100Mbps Fast Ethernet
    - One(1) RS-232C Console (RJ45)
  - **Three(3) VoIP Module Slots for FXS, FXO, E1/T1, etc**



# Hardware Specification

IPNext187 Next Generation Hybrid IP-PBX System

64bit  
CPU

DSP

## IPNext187 Front Side



LAN1 (10/100Mbps)  
LAN0(10/100Mbps)  
Console Port

# Hardware Specification

IPNext187 Next Generation Hybrid IP-PBX System

64bit  
CPU

DSP

## IPNext 187 Back Side

PSTN Analog Module (FXS, FXO, etc)

PSTN Digital E1/T1 Module



Power Inlet

Power Switch

Hot-Swap Switch & LAMP Indication





# Hardware Specification

IPNext187 Next Generation Hybrid IP-PBX System

64bit  
CPU

Audio  
Codec

- **VoIP Interface Module**

<b>AP-N1-FXS8</b>		8-Port FXS Voice Processing Module (8 x RJ11)
<b>AP-N1-FXO8</b>		8-Port FXO Voice Processing Module (8 x RJ11)
<b>AP-N1-FXO4S4</b>		4-Port FXO and 4-Port FXS Voice Processing Module (8 x RJ11)
<b>AP-N1-E1T1</b>		1-Port VoIP Digital E1/T1 Interface Module(1xRJ45)



# Hardware Specification

IPNext187 Next Generation Hybrid IP-PBX System

RISC  
CPU

High-end  
DSP

24-Port(8x3Module) FXS Gateway Service Diagram

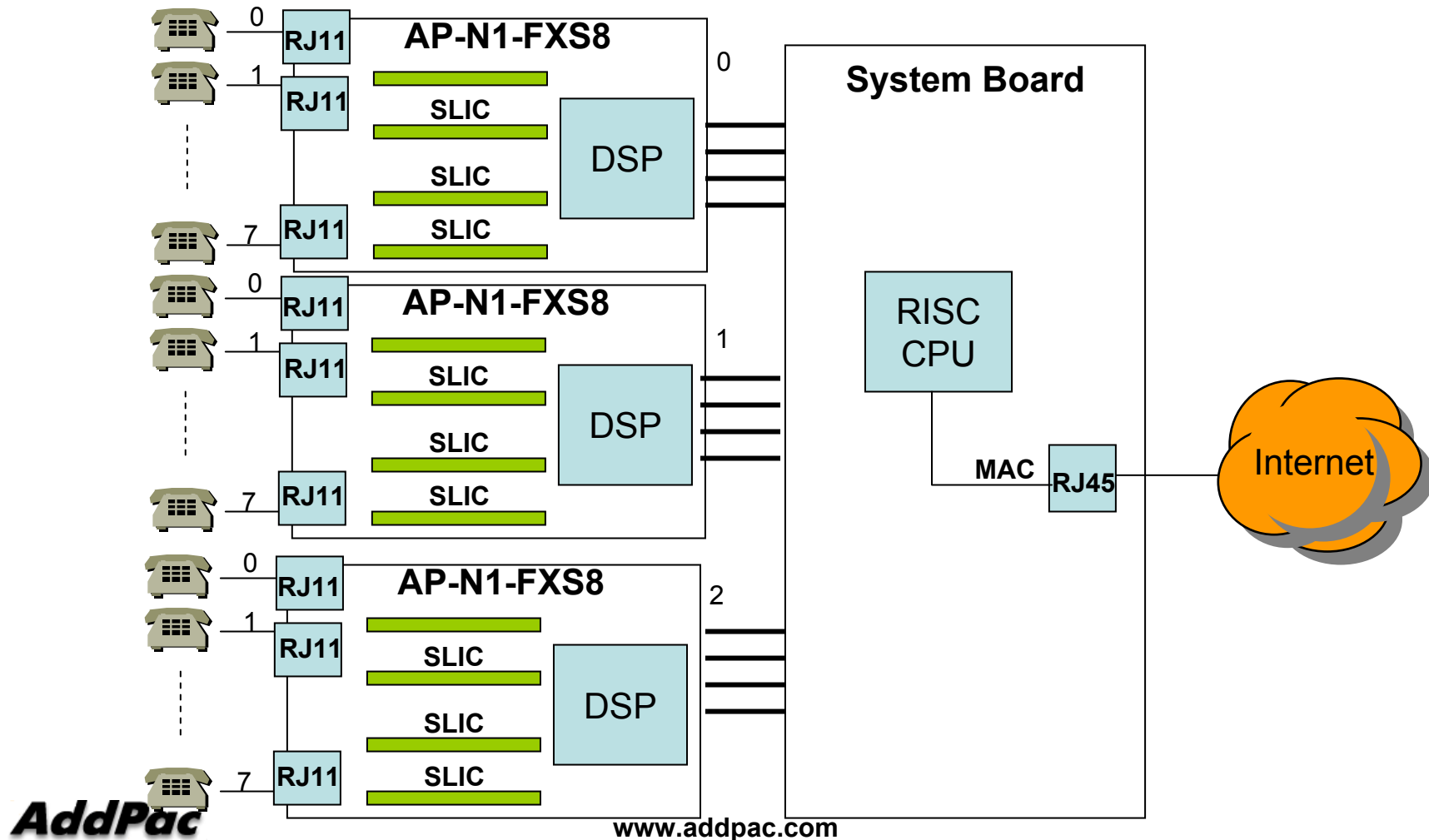

# Hardware Specification

IPNext187 Next Generation Hybrid IP-PBX System

RISC  
CPU

High-end  
DSP

16-Port FXS+ 1-Port Digital E1/T1 Service Diagram

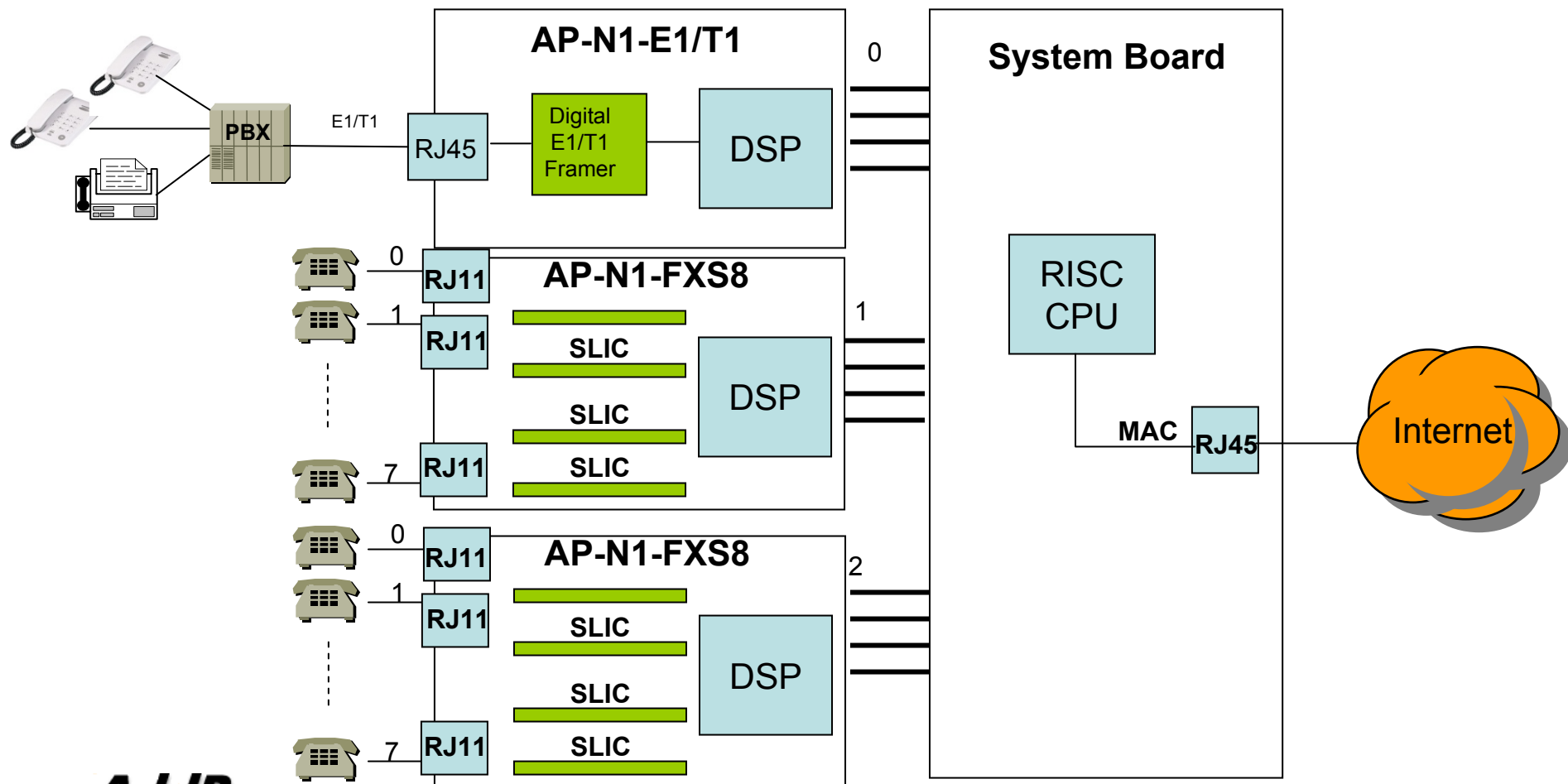

**AddPac**

www.addpac.com

# Software Service

IPNext187 Next Generation Hybrid IP-PBX System

- **Built-in AddPac APOS Internetworking Software**

- Scalability, Functionality, and Stability Features
- Advanced Call Manager Features
- Media Gateway Features
- QoS Control Features

- **Programmable Video, Audio, and Voice Services**

- Audio, and Voice Codec

- **Firmware Upgradeable Architecture**

- **Industry Standard Network Protocol Features**

- **Highly User Friendly Management Features**

- Smart Messenger for UC
- Smart Multimedia Manager

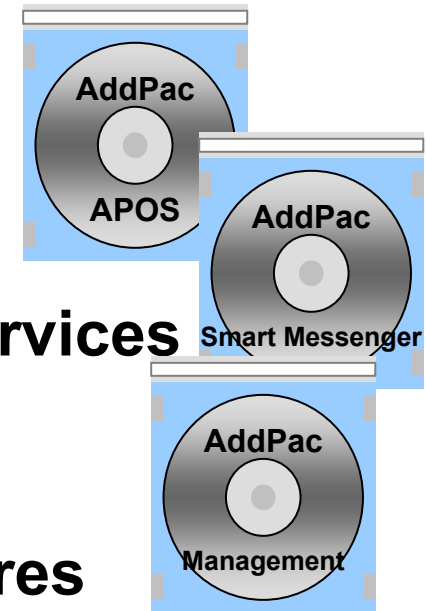

# IP-PBX Software Components

IPNext187 Next Generation Hybrid IP-PBX System

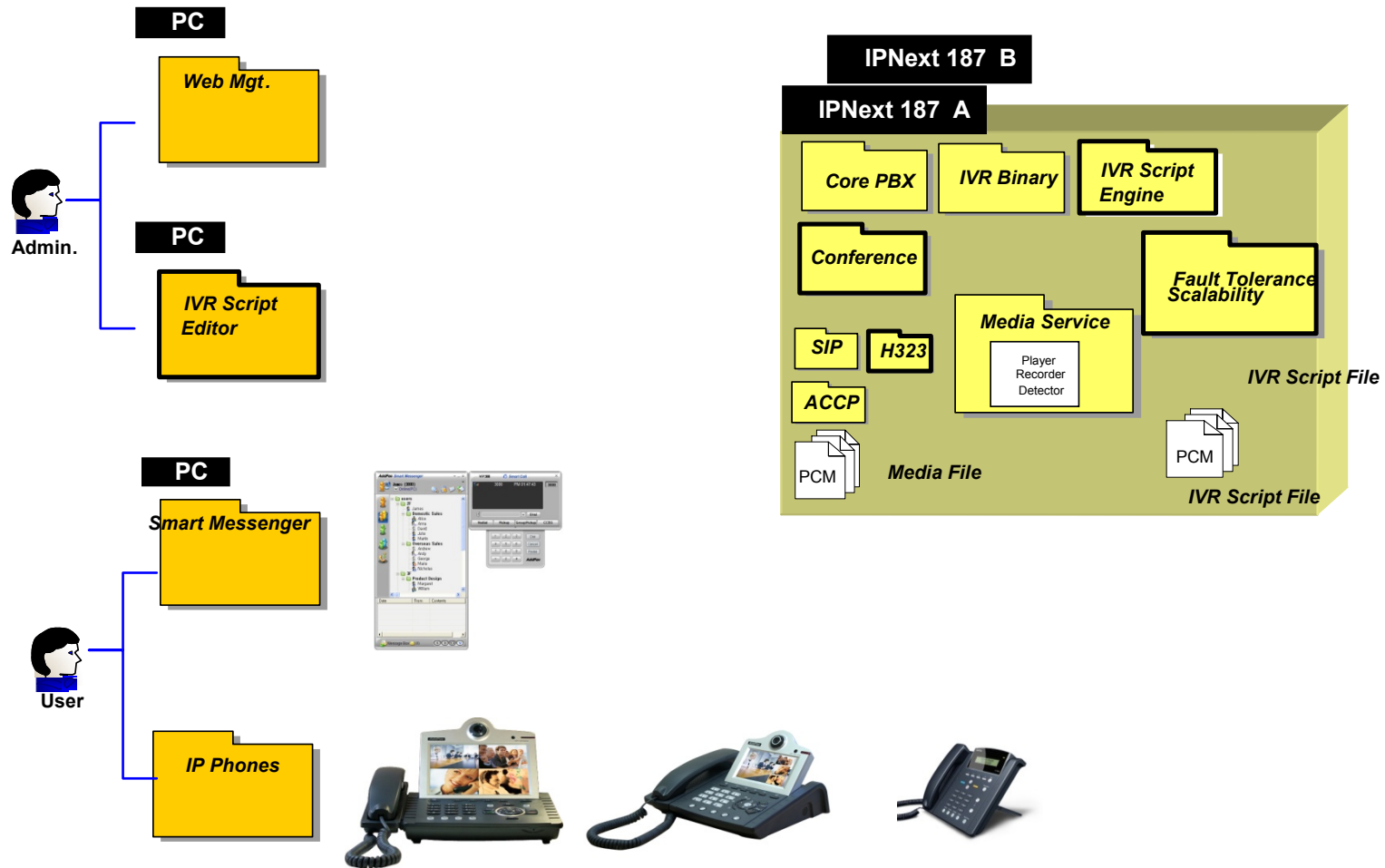

# IP Telephony Service and Features

## IPNext187 Next Generation Hybrid IP-PBX System

- **Signaling Server**

- SIP Application Server, Proxy, Registrar and Location Server (RFC3261)
- Multiple ITSP Trunk with SIP & H.323 Accounts Support
  - IP UA Client Role for Registering to ITSP SIP Server
  - H.323 Gatekeeper Client Role for Registering to ITSP H.323 Gatekeeper Server

- **IVR & Auto Attendant**

- Default Auto Attendant Support
- Interactive Voice Response (IVR)
  - Provides with GUI-based Smart IVR Scenario Editor
  - Upload/Download Scenario by Smart IVR Scenario Editor
  - Supports Multiple Concurrent Scenarios
  - Supports Recordable IVR Prompts

- **Voice Mail**

- Support Voice Mail with IVR
- Access from Remote Site via Trunk Support
- Voice Mail Notification Support

# IP Telephony Service and Features

## IPNext187 Next Generation Hybrid IP-PBX System

- **Number & Call Routing**

- Trunk Hunting by Preference or Sequential
- Call Hunting by Preference, Simultaneous, Random
- Call Hunting by Chained Hunting Group
- Partition for Address Grading
- Call Class for Call Access Control
- Number Translation Rule for Inbound/Outbound Call
- Centrex with Prefix Support
- Multiple Shared Devices with One Number
- Multiple Numbers on One Device
- Individual Call Park within Park Number Pool
- Group Call Park within a Group or Other Group
- Call Pickup of Ringing Call of Same Group or Other Group
- Call Pickup of Parked Call
- Call Transfer - Blind, Consult
- Call Forwarding - Unconditional, Busy, No Answer, Voice Mail
- Call Waiting
- Call Swaping
- Call Hold

# IP Telephony Service and Features

## IPNext187 Next Generation Hybrid IP-PBX System

- **IP-PBX Advanced Features with AddPac IP Phones**

- Multiple Call Handling with Call Status and Calling Line Number and Name
- Plug and Play with Auto Discovery Function
- Softkey Map Download and Control
- Time and Date Setting
- Voice Mail List View
- Parked Call List View
- Call Forward Setting
- Recent Call List View
- Calling Number and Name Identification
- Individual Call Park within Park Number Pool by Softkey
- Group Call Park within a Group or Other Group by Softkey
- Call Pickup of Ringing Call of Same Group or Other Group by Softkey
- Call Pickup of Parked Call by Softkey
- Call Transfer - Blind, Consult by Softkey
- Call Waiting Indication
- Call Swaping by Softkey
- Call Hold by SoftKey
- Conference Control

# IP Telephony Service and Features

## IPNext187 Next Generation Hybrid IP-PBX System

- **User & Device Management**
  - LDAP (Light weight Directory Access Protocol) Support
    - Supports Hierarchical Organization
  - Auto Discovery of IP Phones & Video Phones
  - Monitoring Status of Phones
- **Miscellaneous\***
  - Distinctive Ring by Calling User
  - Auto Config & Upgrade
  - Personal Directory
  - Downloadable Ring
  - Do not Disturb



# IP Telephony Service and Features

## IPNext187 Next Generation Hybrid IP-PBX System

- **Conference**

- G.711 (4-party Conference, 2 session) : basic
- G.711/G.729/G.723 (4-party Conference, 2session) Internal MCU Module : Option
- Ad-hoc Conference
- Dial-Out Conference
- Meet-me Conference
- Multiple External MCU support( Video, Audio, etc) : AddPac AP-MC1000, etc
- Conference Chair and Participants Management

- **Music & Announcement**

- Music on Hold
- Replaceable Announcements
- Dialing Music / Tone Service

# SIP based Basic Call Scenario

IPNext187 Next Generation Hybrid IP-PBX System

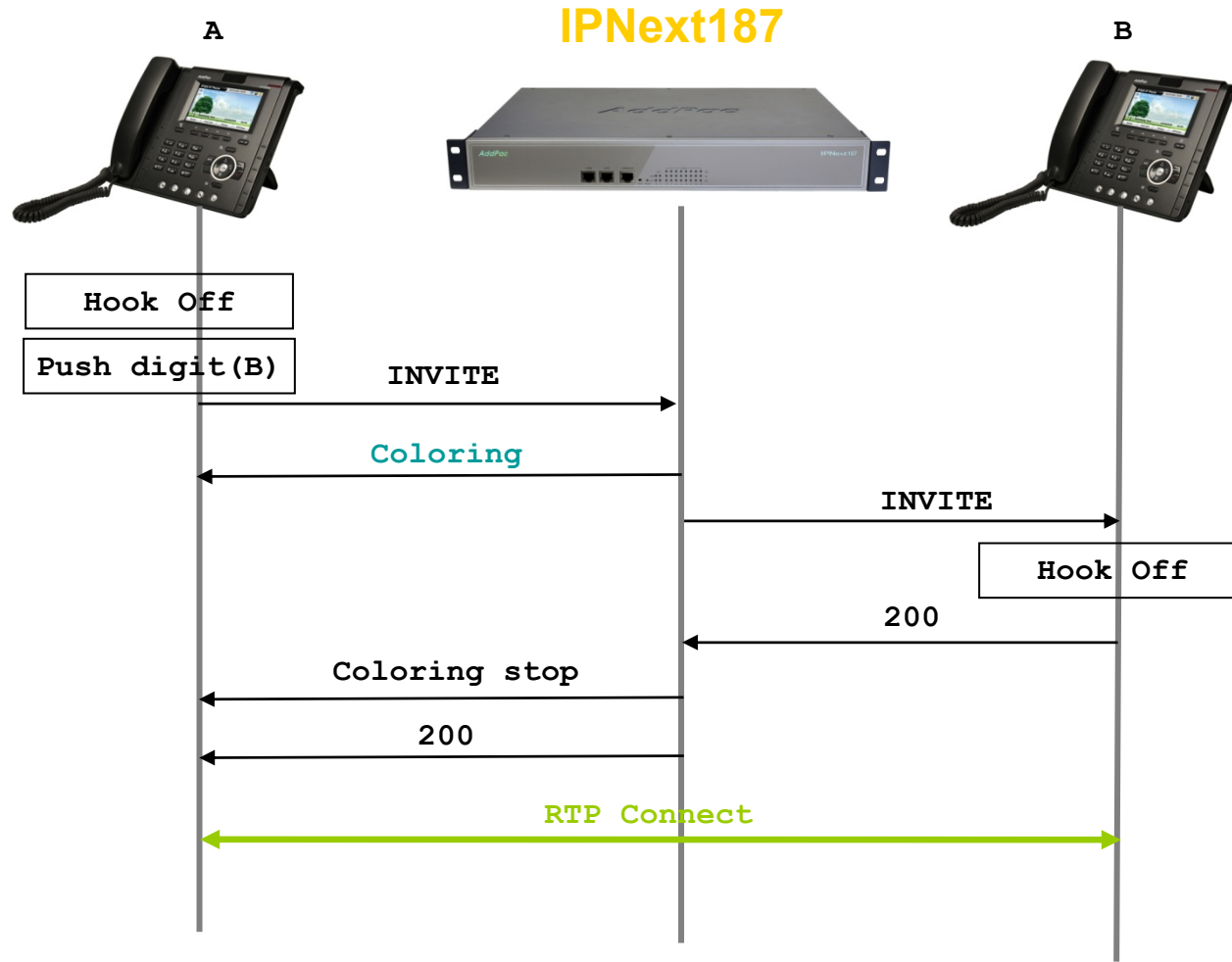

# RTP Proxy Service

IPNext187 Next Generation Hybrid IP-PBX System

Public/Private RTP Proxy  
without NAT Router

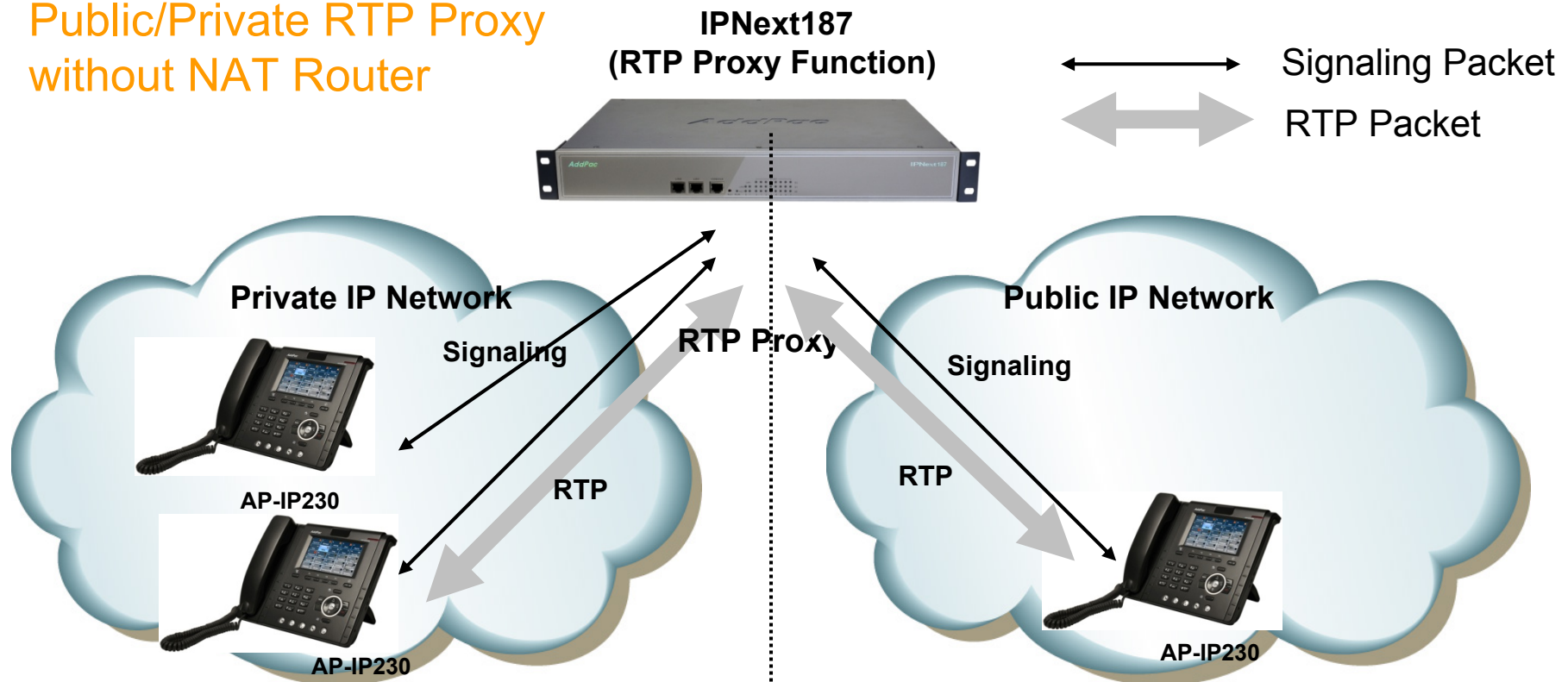

- Located between public and private network
- IPNext187(Call manager + RTP proxy) has public and private address
- IPNext187 determine that the call is internal or external

# RTP Proxy Service

IPNext187 Next Generation Hybrid IP-PBX System

## Asymmetric/Symmetric NAT

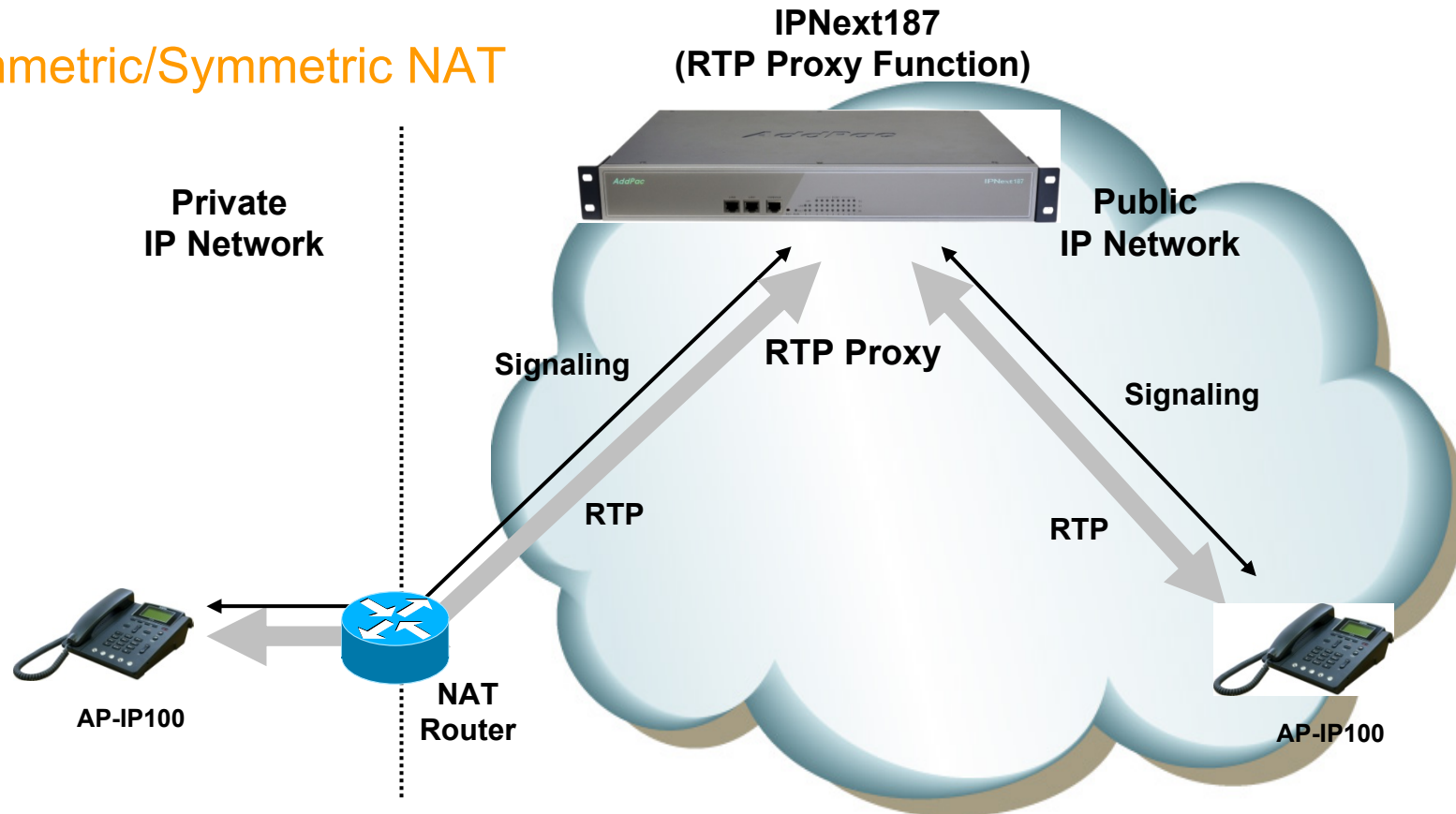

- Located in public network
- RTP Proxy has single public address
- Auto detect for asymmetric NAT via incoming RTP packet

# RTP Proxy Service

IPNext187 Next Generation Hybrid IP-PBX System

## RTP Proxy Communication between Private IP

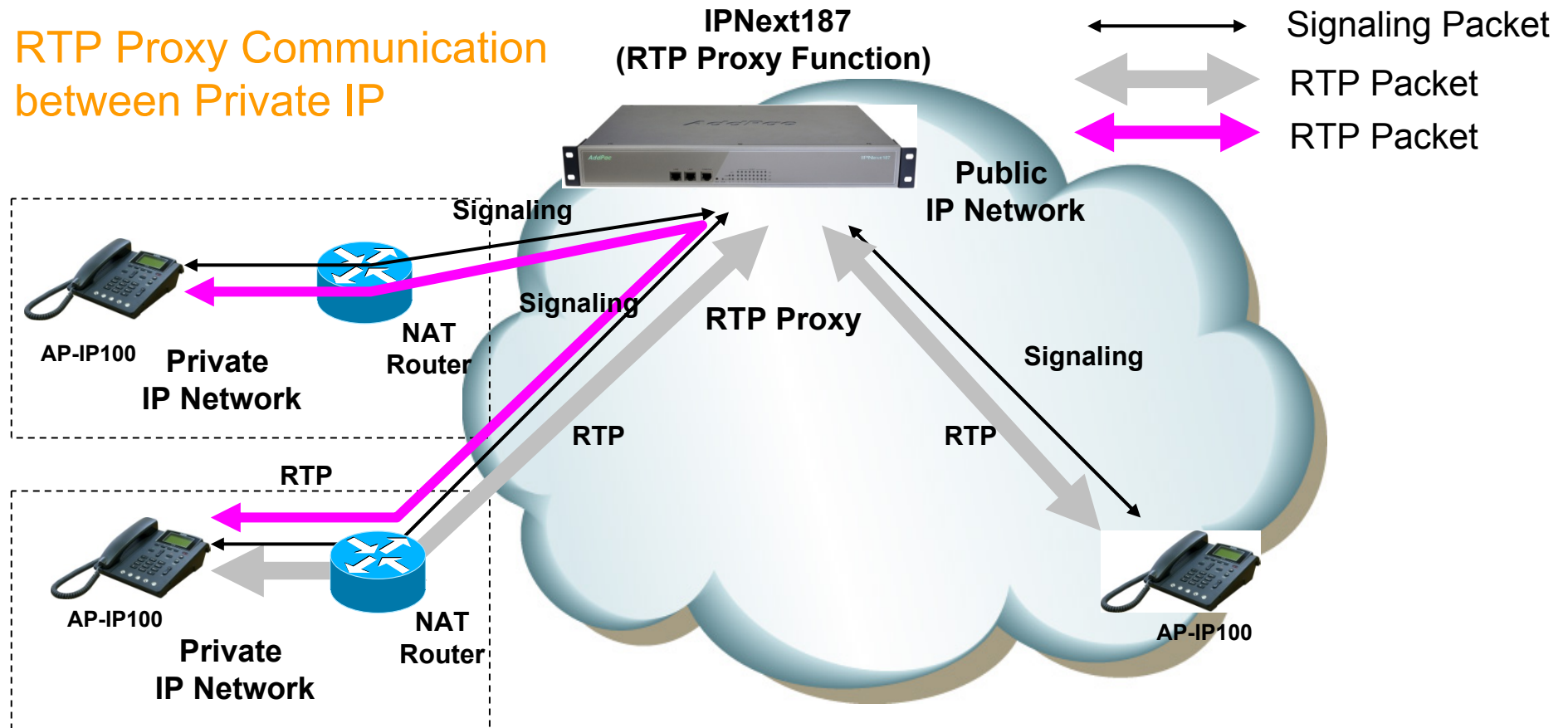

- Located in public network
- RTP Proxy has single public address
- Auto detect for asymmetric NAT via incoming RTP packet

# RTP Proxy Service

IPNext187 Next Generation Hybrid IP-PBX System

IPv4/IPv6 RTP Proxy

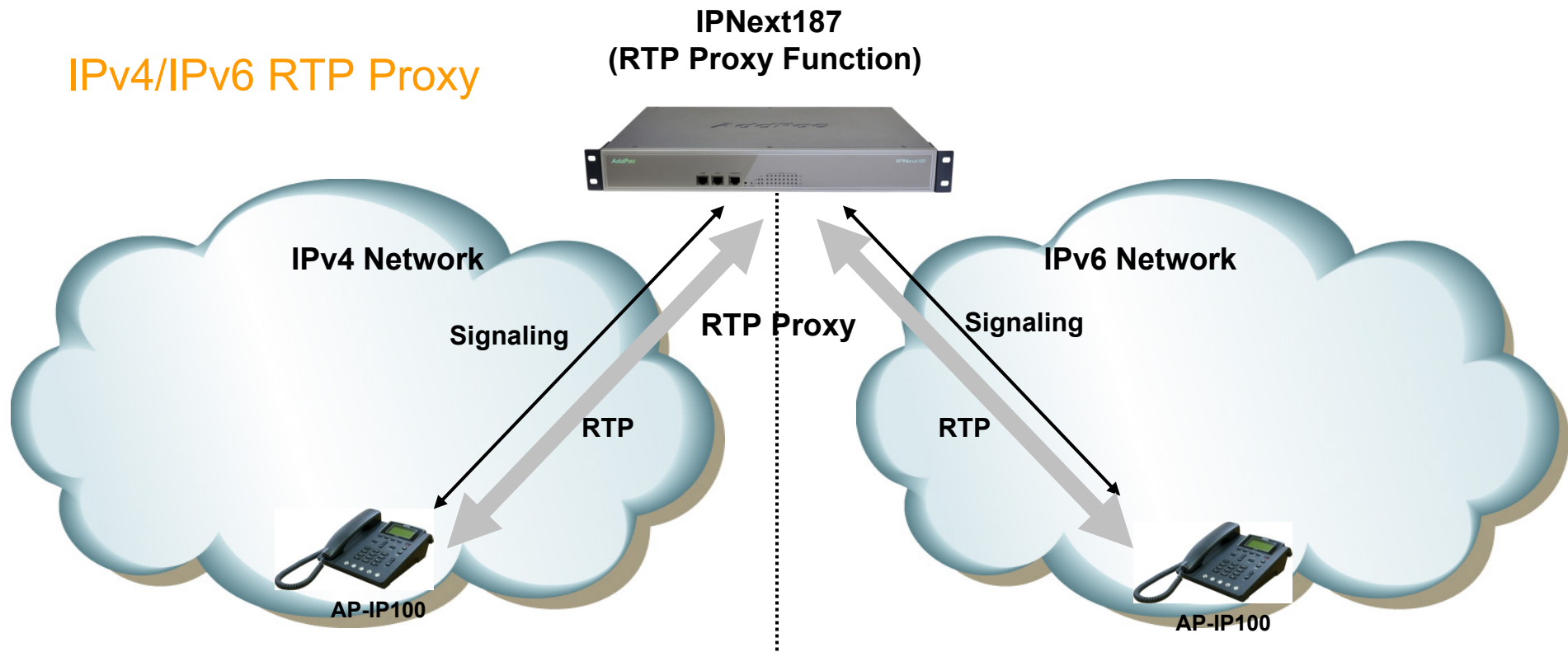

- IPNext187(Call manager + RTP proxy) has IPv4 and IPv6 address

# User Presence Service for UC

IPNext187 Next Generation Hybrid IP-PBX System

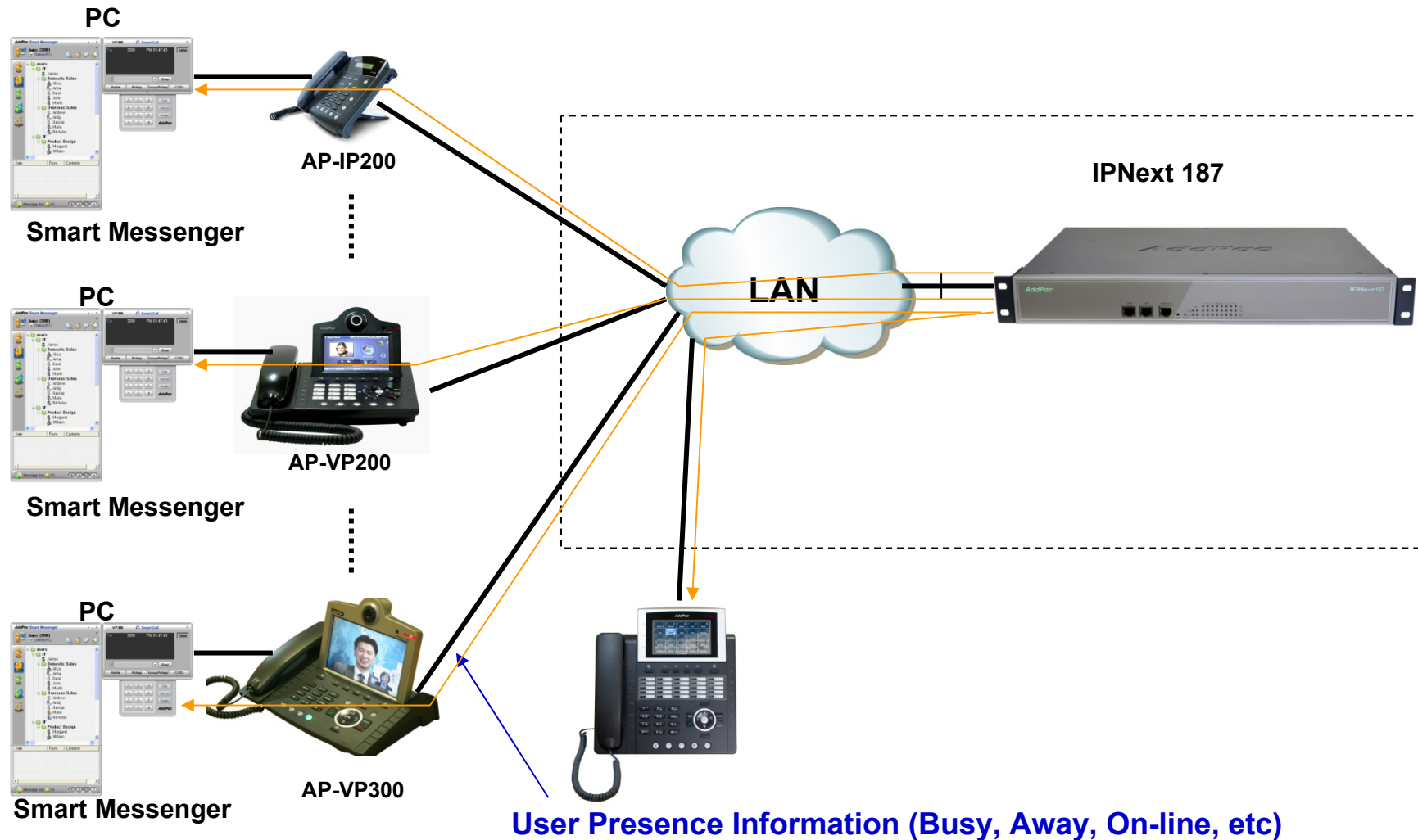

# Network Service and Features

IPNext187 Next Generation Hybrid IP-PBX System

## Basic Network Protocols

- ARP, IP, IPv6, TCP, UDP, ICMP, ICMPv6, SCTP, IGMP, MLD

## Routing Protocol

- IPv4 : Static
- IPv6 : Static

## Service Protocol

- FTP, Telnet, TFTP, DHCP Server/Relay, SNMP Server
- CDP (Cisco Discovery Protocol)
- DNS Resolver , DDNS(nsupdate)
- Bridge
- Syslog
- IP/IPv6 policy control (QoS)
- VPDN (Virtual Private Dial-up Network : L2TP Server)



# Network Service and Features

IPNext187 Next Generation Hybrid IP-PBX System

## **IPv4/IPv6 Interworking**

- NAT/PAT for IPv4
- IP connect (formerly ip-share) and device cascade for IPv4
- IP/IP, IP/GRE tunneling
- NAT-PT
- 6to4, Autoconfig tunneling

## **IPv4 Address Configuration**

- Fixed (Static)
- DHCP
- PPPoE

## **IPv6 Address Configuration**

- Fixed (Static)
- EUI-64
- Autoconfig (Neighbor Advertisement and Solicitation)

# Network Service and Features

IPNext187 Next Generation Hybrid IP-PBX System

## **Miscellaneous**

- Cisco Style CLI
- Standard & Extended IPv4/IPv6 Access List
- Multi-level User Account Management
- IP accounting
- fsh (Embedded file system shell)
- STUN Client

# Network Service and Features

IPNext187 Next Generation Hybrid IP-PBX System

## **SNMP MIBs**

- MIB-II
- RMON MIBs (Statistics, History, Alarm, Hosts Group)
- RFC2465 Management Information Base for IP Version 6: Textual Conventions and General Group
- RFC2466 Management Information Base for IP Version 6: ICMPv6 Group
- RFC2452 IP Version 6 Management Information Base for the Transmission Control Protocol
- RFC2454 IP Version 6 Management Information Base for the User Datagram Protocol
- AddPac Enterprise MIBs
- etc

# User Terminals

## IPNext187 Next Generation Hybrid IP-PBX System

- AP-VP500 Video Phone
- AP-VP350 MCU Video Phone
- AP-VP300 Video Phone
- AP-VP280 Video Phone
- AP-VP250 Video Phone
- AP-VP230 Video Phone
- AP-VP150 Video Phone
- AP-VP120 Video Phone
- AP-IP300 Premium IP Phone
- AP-IP230 IP Phone
- AP-IP160 IP Phone
- AP-IP120 IP Phone
- AP-IP90 IP Phone
- AP-WP100 WiFi Phone
- AP-SMP100 Soft Phone



AP-VP500



AP-VP300



AP-VP150



AP-VP120



AP-IP300



AP-WP100











AP-IP160



AP-IP120

# IP Video Phone Comparison Table

	AP-VP500	AP-VP350	AP-VP300N	AP-VP280	AP-VP250	AP-VP230	AP-VP150	AP-VP120
								
LCD Size	12.1 Inch Touch Screen	7Inch Touch Screen	7Inch Touch Screen	7Inch Touch Screen	4.3Inch Touch Screen	5Inch Touch Screen	4.3Inch Touch Screen	4.3Inch
Camera	CCD	CCD	CCD	CMOS	CMOS	CMOS	CCD	CMOS
Video Codec	H.263 MPEG4 H.264	H.263 MPEG4 H.264	H.263 MPEG4 H.264	H.263 MPEG4 H.264	H.263 MPEG4 H.264	H.263 MPEG4 H.264	H.263 MPEG4 H.264	H.263 MPEG4 H.264
Signaling	H.323/SIP	H.323/SIP	H.323/SIP	H.323/SIP	H.323/SIP	H.323/SIP	H.323/SIP	H.323/SIP
Video MCU	N/A	4-Party Video MCU	N/A	N/A	N/A	N/A	N/A	N/A
Voice MCU	3-Party	3-Party	3-Party	3-Party	3-Party	3-Party	3-Party	3-Party
LAN Port	2	2	2	2	2	2	2	2
PoE	N/A	N/A	Support	N/A	Support	Support	Support	Support

# IP Phone Comparison Table

	AP-IP300 	AP-IP250 	AP-IP230 	AP-IP160 	AP-IP120 	AP-IP90 
LCD Size	4.3 Inch Color LCD	4.3 Inch Color LCD	5 Inch Color LCD	4 Text Line Graphic LCD	4 Text Line Graphic LCD	4 Text Line Graphic LCD
Touch Screen	N/A	Support	Support	N/A	N/A	N/A
Speed-Dial Keys	25 Key with Presence LED	Touch Screen based 25 Keys	Touch Screen based 25 Keys	16 Key with Presence LED	12 Key with Presence LED	N/A
Voice Codec	G.711/G.726/ G.729/G.723	G.711/G.726/ G.729/G.723	G.711/G.726/ G.729/G.723	G.711/G.726/ G.729/G.723	G.711/G.726/ G.729/G.723	G.711/G.726/ G.729/G.723
Signaling	H.323/SIP	H.323/SIP	H.323/SIP	H.323/SIP	H.323/SIP	H.323/SIP
3-Party Conversation	Support	Support	Support	Support	Support	Support
LAN Port	2	2	2	2	2	2
PoE(Optional)	Support	Support	Support	Support	Support	Support
FXO(Optional)	Support	Support	Support	Support	Support	Support

# Smart Messenger for UC

IPNext187 Next Generation Hybrid IP-PBX System

- **Smart Messenger Program**

- PC based MS-Window Program
- Support Messenger Service
- Support Various Address Book
- Support User Presence Information (Busy, Away, On-line, etc)
- Support User Search Feature
- Interoperation with Address Book and Smart Phone
- Support Smart Phone Control and Setup
  - Call Control and Forward Setup
- Support Unified Message Box
  - Voice Mail Box
  - Short Message Box



**Smart Messenger**



# Standard Hybrid IP-PBX System Application

IPNext187 Next Generation Hybrid IP-PBX System

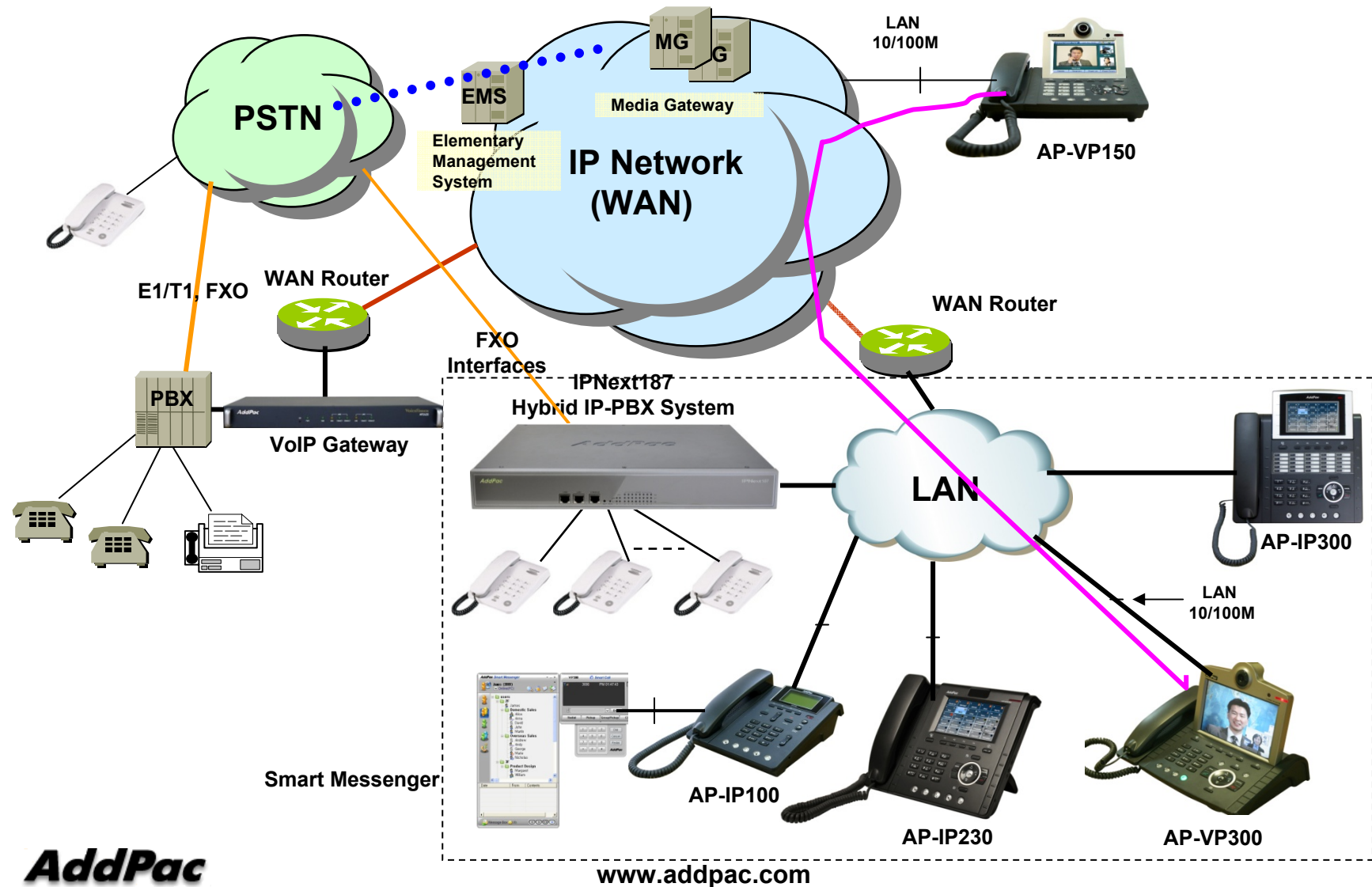



# Ordering Information

- **IPNext187 Next Generation Hybrid IP-PBX System**
  - IPNext187 Hybrid IP-PBX System Main Body
  - High-performance 64bit RISC CPU
  - 2-ports 10/100Mbps Fast Ethernet and 1-port RS-232C Console
  - Internal Power Supply
  - Including Network Cable Set & Power Supply Cable, etc.
  - VoIP Interface Modules (Option)
- **Built-in APOS Internetworking Software for IPNext187**
- **Including 1 Year Hardware Warranty**
- **Product Documents**
  - Install and Operation Guide (PDF)
- **Pricing**
  - AddPac Technology Regional Sales Manager
  - Authorized Sales and Marketing Representatives
  - Please Contact [www.addpac.com](http://www.addpac.com)



# Thank you!

**AddPac Technology Co., Ltd.**  
Sales and Marketing

Phone +82.2.568.3848 (KOREA)

FAX +82.2.568.3847 (KOREA)

E-mail [sales@addpac.com](mailto:sales@addpac.com)