

# VoIP

## AP-MG3000 Next Generation Media Gateway



Technical Sales and Marketing

AddPac Technology

[www.addpac.com](http://www.addpac.com)

# AP-MG3000 Next Generation Media Gateway

## Media Gateway Connectivity



No.	Interface	Explanation
(1)	Asynchronous Serial	One(1) RS-232C serial ports for Local system management
(2)	AUX Port	One(1) RS-232C serial ports for AUX serial Interface such as Modem
(3)	Fast Ethernet	Two(2) 10/100 Fast Ethernet Ports for LAN interface
(4)	Module Slot 0-2	Two(2) Digital E1/T1 Interface Module Slot

# AP-MG3000 Media Gateway Product Overview

## APOS Internetworking Protocol Stack

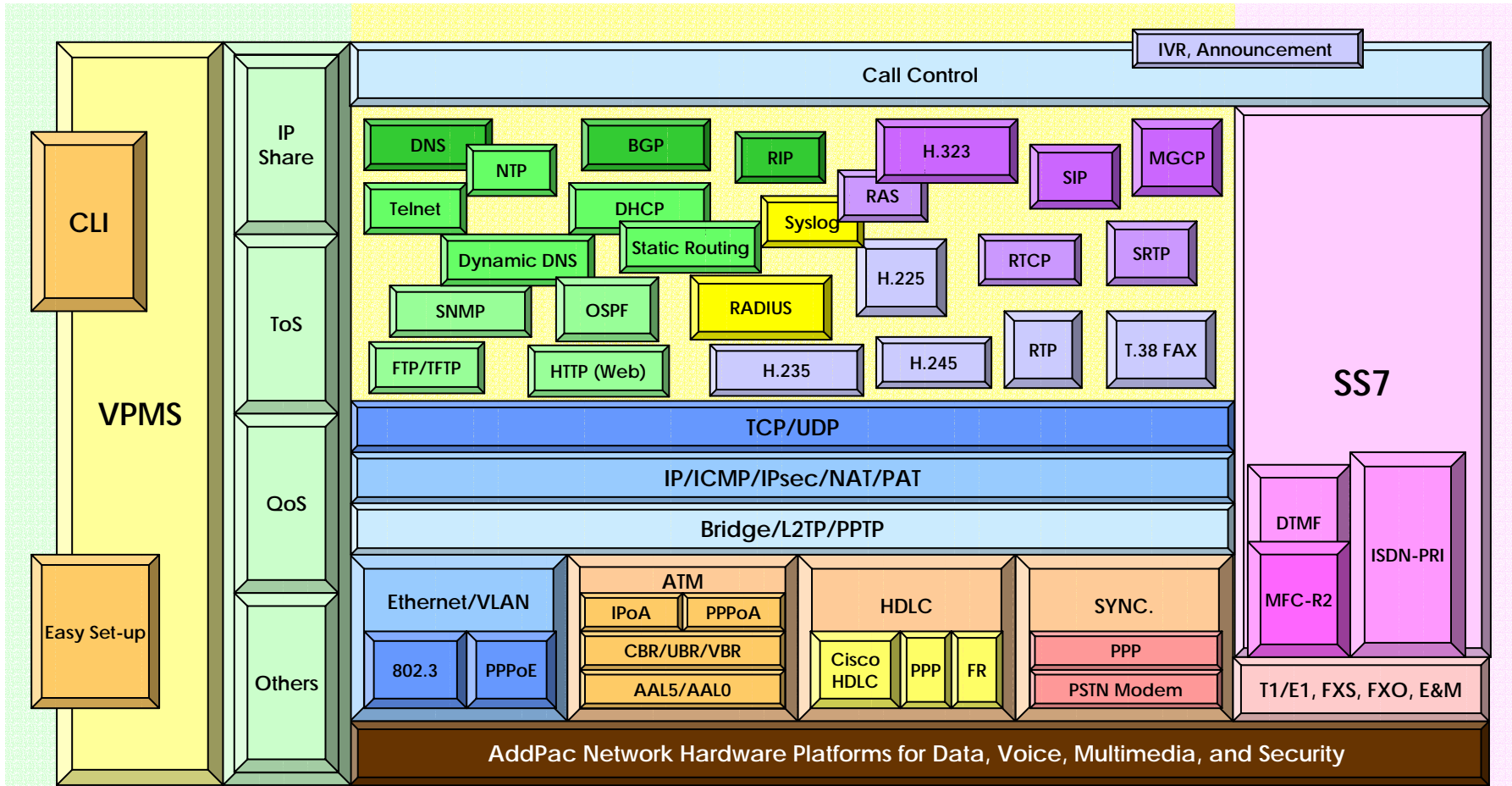



# AP-MG3000 Media Gateway Product Overview

## APOS Internetworking S/W World (cont.)

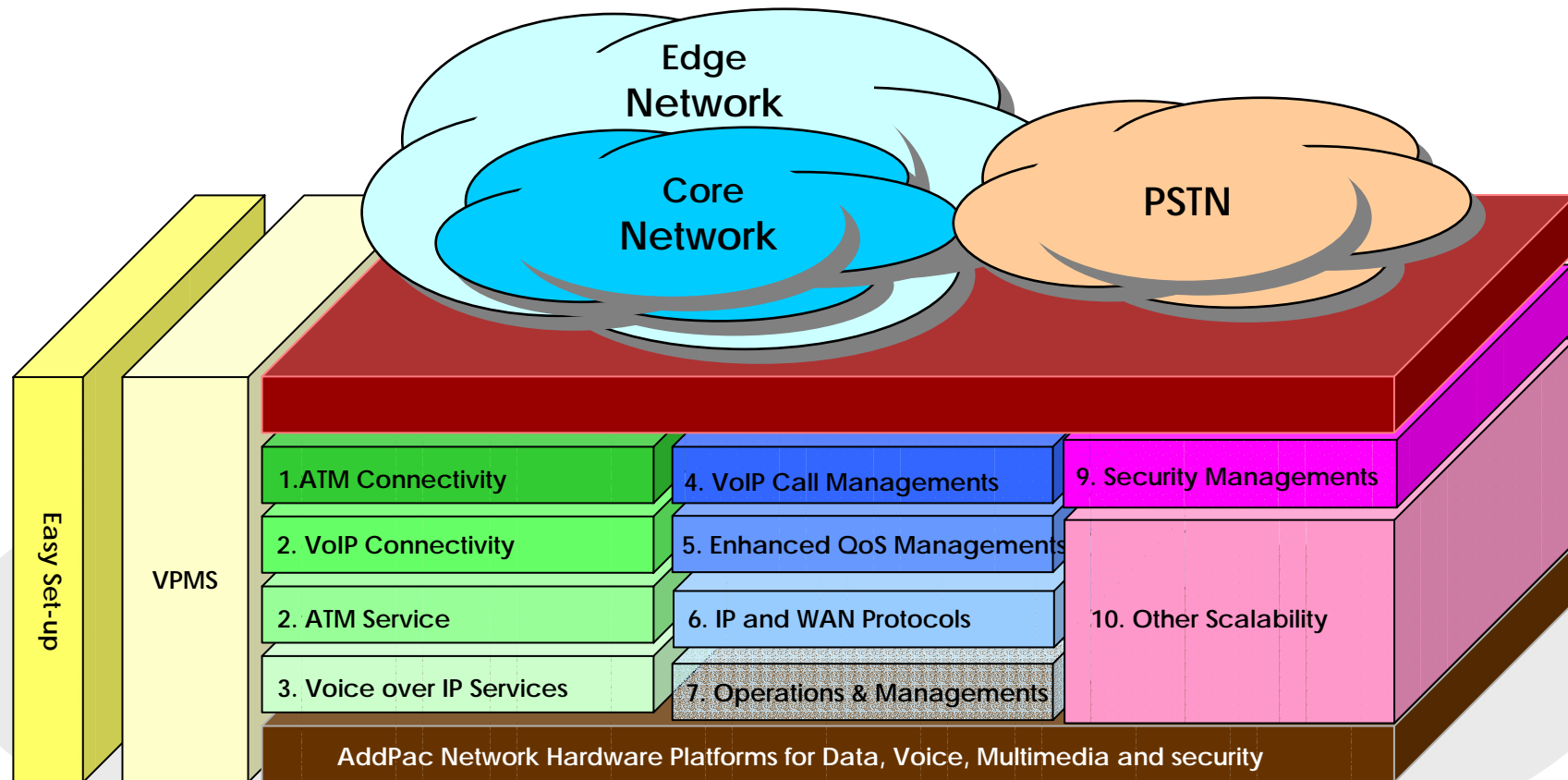

# AP-MG3000 Media Gateway Product Overview

## Digital E1/T1 Interface Connectivity

- E1/T1

- ISDN PRI signaling support (network mode, user mode)
- R2 signaling support (calling number receive support)
- DTMF signaling support
- Clock source master mode, slave mode support
- In case of channel allocation, ascending / descending random support
- One physical E1/T1 interface can be divided into several logical channel groups
- Super frame, extended super frame T1 framing support
- AMI, AMI-BELL, AMI-GTE, AMI-DDS, B8ZS T1 line code support
- Immediate, Wink-start T1 CAS type support
- SS7\*

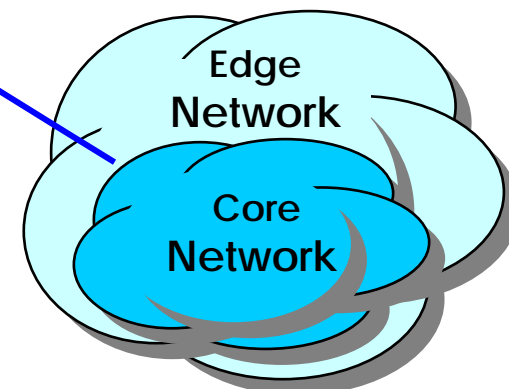
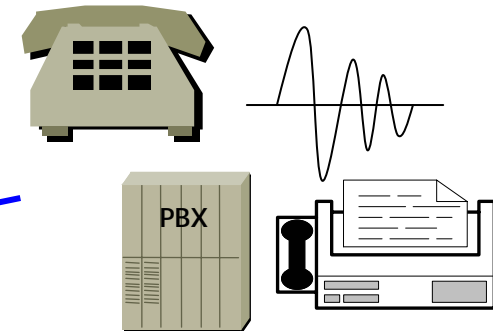

# AP-MG3000 Media Gateway Product Overview

## Voice over IP Service

- H.323, SIP, and MGCP Triple Stack
  - Concurrent Triple VoIP Stack Software
  - Single Hardware with Three VoIP Service
  - New APOS-NX Version
- H.323
  - ITU-T Standard H.323 v3 Support
  - Support H.245 Tunneling
  - Including H.235 Security Features
- SIP
  - IETF RFC3261 or RFC2543 SIP Standard
- MGCP
  - IETF RFC2705bis-02 Standard MGCP 1.0

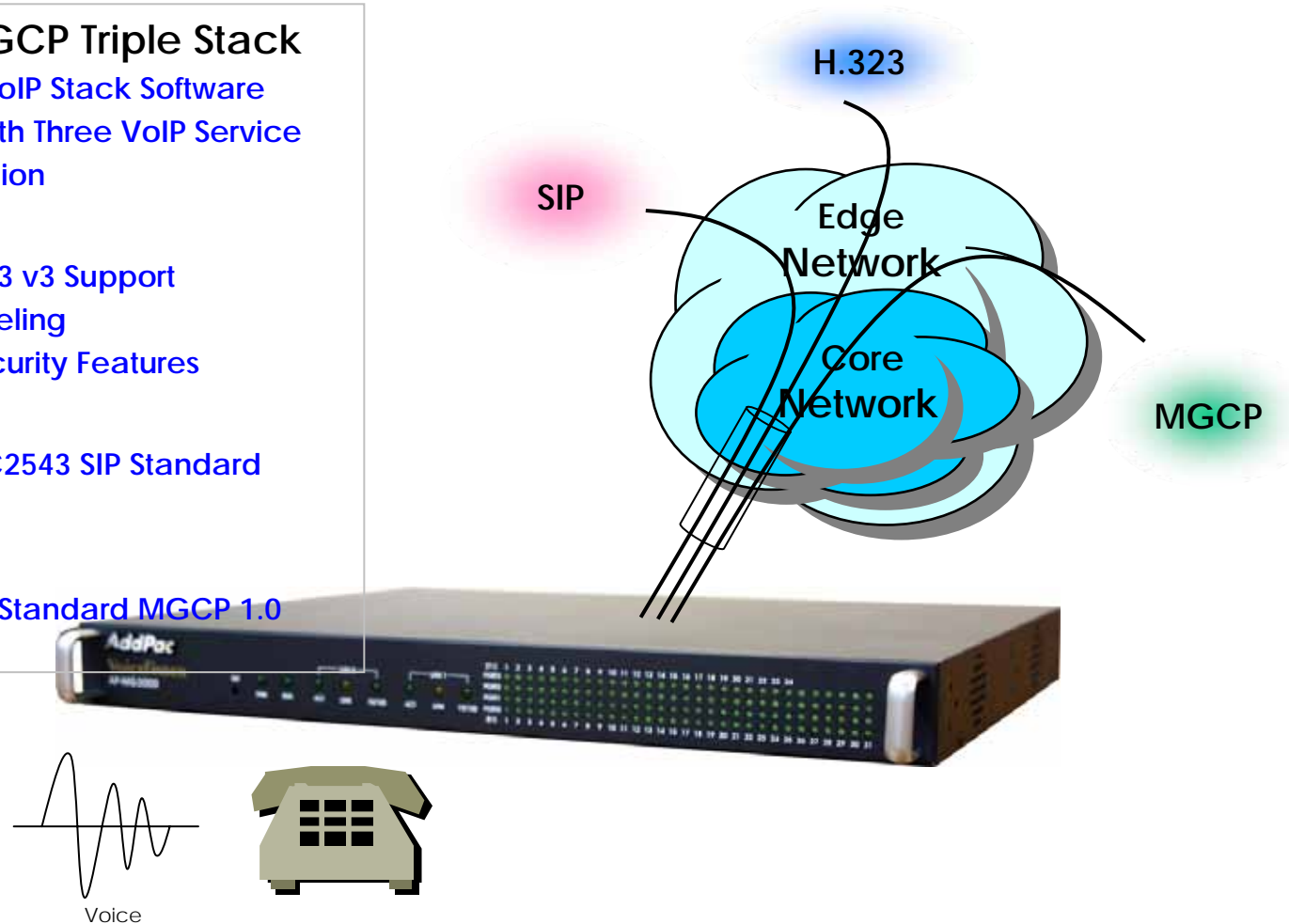

# AP-MG3000 Media Gateway Product Overview

## Voice over IP Service (cont.)

- H.323

- Fast connect, normal connect support
- H.245 tunneling support
- Q.931 response message setting for inbound VoIP calls
- H.245 logical channel open timing selection function
- Start H.245 procedure support
- DTMF / Hook flash relay with H.245 alphanumeric / signal
- Secondary gatekeeper support
- Gatekeeper assignment according to the domain name
- Gatekeeper discovery with multicast
- Lightweight RRQ support
- Signaling TCP port assignment
- Resource threshold setting with RAI
- H.235 clear-token, crypto-token support
- canMapAlias support
- Technical prefix (supported prefix) support
- Public IP assignment in NAT environment

- SIP

- Gateway-based / Endpoint-based registration support
- Secondary proxy-server assignment function
- SIP signaling port change function
- SIP proxy server assignment according to the domain name
- T.38 real-time fax relay support
- DTMF relay support with RFC2833 / OPTION message
- Re-INVITE support

- MGCP

- Secondary call agent assignment function
- Default package assignment
- Announcement Server Package, Generic Media Package, Handset Package, Line Package, Trunk Package support
- MGCP call agent assignment according to the domain name
- T.38 real-time fax relay support
- DTMF relay support based on RFC2833



# AP-MG3000 Media Gateway Product Overview

## Voice over IP Service (cont.)

### • Voice Codec

- G.711 A-Law, G.711 U-Law
- G.726 r16, G.726 r32
- G.729A
- G.723.1 r63, G.723.1 r53
- VAD (Voice Activity Detection) function support
- DTMF relay support (H.323, SIP, MGCP common) based on RFC2833

### • RTP

- Redundant RTP packet transmission in case of severe packet loss
- Dynamic jitter buffer management and RTP packet jitter and loss compensation with heuristic & DSP error concealment
- Static jitter buffer setting support
- Voice frame per RTP packet number control for each codec
- In-band ring-back tone support
- Virtual ring-back tone support
- Tone parameter change support

### • FAX

- Fax relay mode supporting T.38, inband-T.38, bypass mode
- Lost packet compensation with redundant setting in case of T.38 fax relay
- Fax relay mode, rate setting for remote end

VoIP

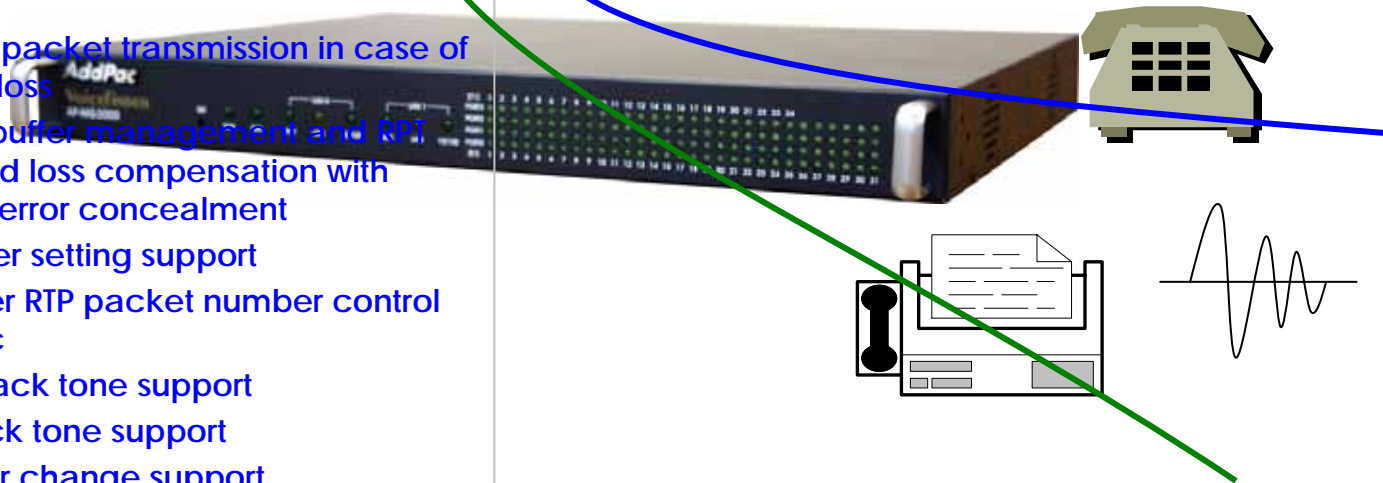

# AP-MG3000 Media Gateway Product Overview

## VoIP Call Managements

### • VoIP Call Controls

- Hot line connection function with PLAR (Private Line Auto Ring Down)
- Leased line emulation function
- Connection monitoring function
- Fault tolerant with Redundancy and Call Distribution among Gateways for load balancing
- Call attempt with IP address
- H.323, SIP, MGCP inbound call connection for each voice port
- Multiple E.164 setting for one voice port
- One E.164 or digit pattern can be assigned to more than one voice port
- Hunting with Longest match/ priority/ sequence/ random
- One stage call setup by Digit forwarding
- Call barring with specific digit patterns
- Calling and called number conversion for PSTN outbound calls
- PSTN rerouting in case of VoIP call attempt failure

### • VoIP Call Controls (cont.)

- Call transfer for internal calls
- Call pickup for internal calls
- Calling and called number conversion for VoIP outbound calls
- Calling and called number conversion for VoIP inbound calls
- Fax broadcasting call control

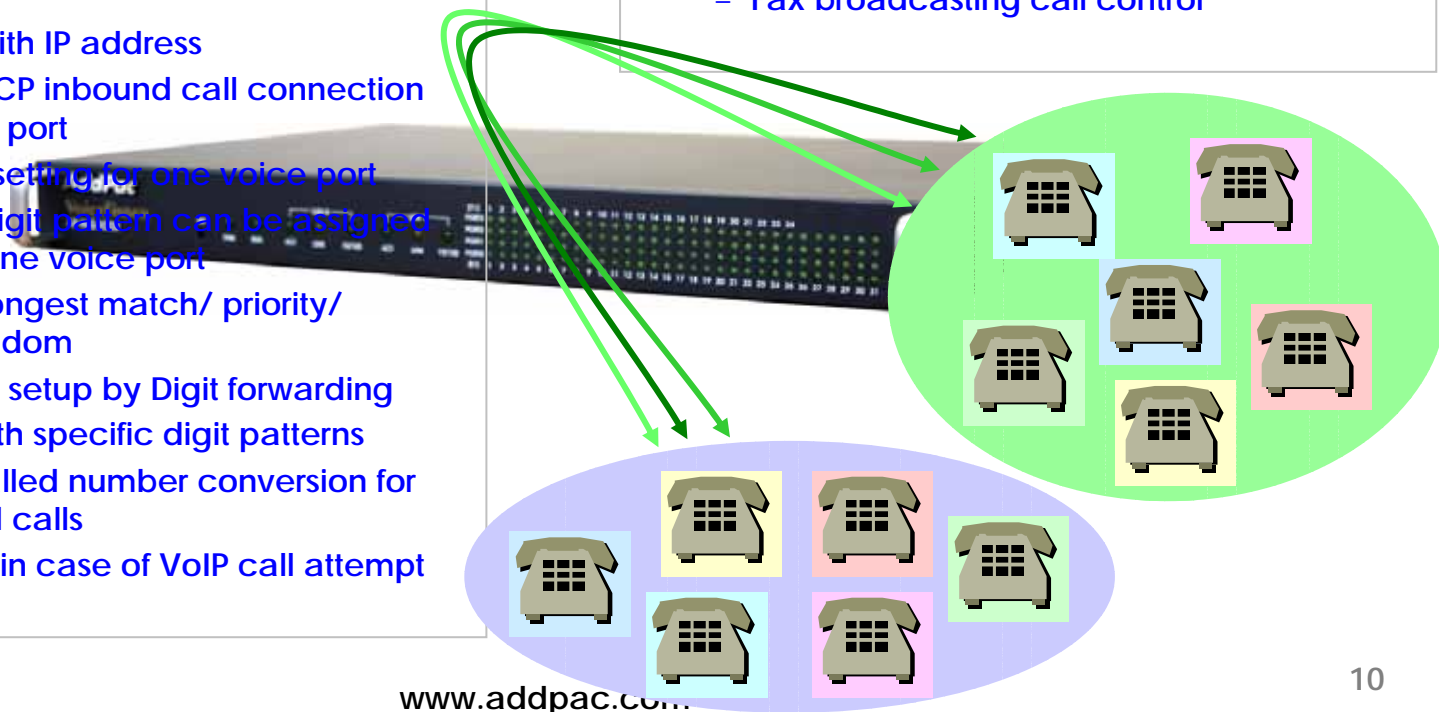

# AP-MG3000 Media Gateway Product Overview

## Enhances QoS Managements

- Enhances **Transmit** Voice QoS Features

- Voice Traffic Priority Queuing
- QoS Service Profiling
- Providing Virtual Network Transmit Algorithm
- Real-time Voice Traffic QoS Support
- RTP Packet Transmit Interval Control
- Supporting RTP Packet Redundancy Scheme
- IP Header Control such as ToS, Diffserv

- Enhances **Receive** Voice QoS Features

- Dynamic Jitter Buffer Management
- Error Concealment
- Support T.38 FAX Data Error Recovery Scheme

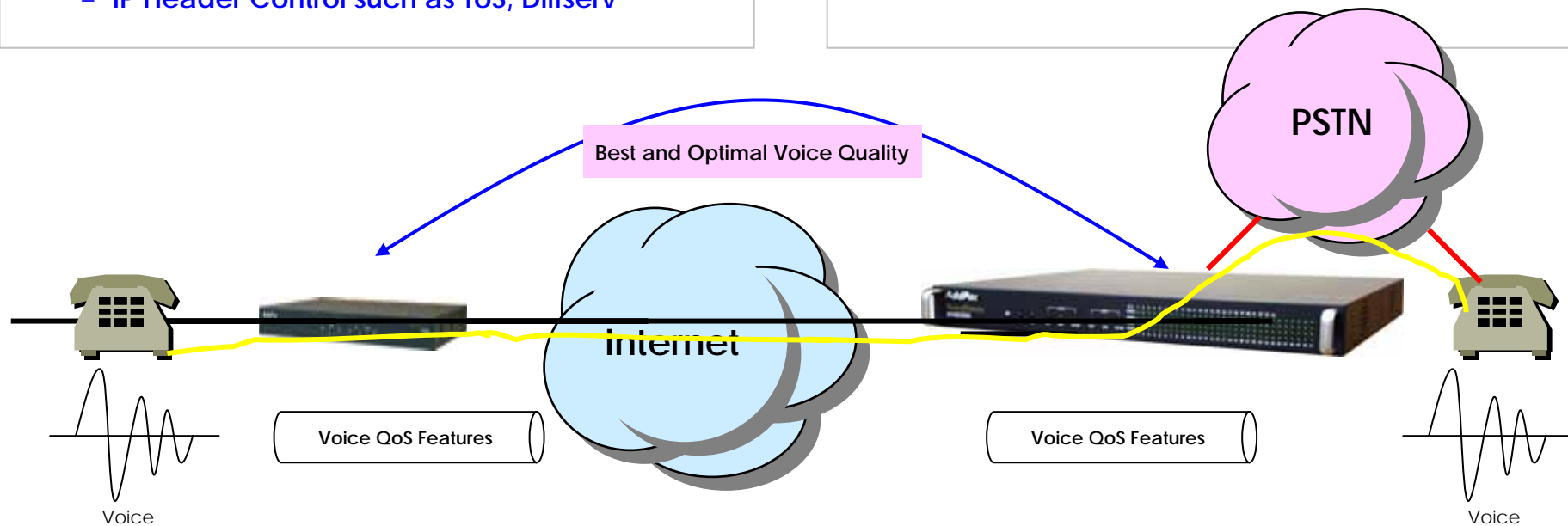

# AP-MG3000 Media Gateway Product Overview

## IP and WAN Protocols

- IP Routing Protocols

- Multi-protocol Internetworking Services
- Static IP routing
- RIP v1/v2 (opt.)
- OSPF v2 routing protocols support (opt.)
- Transparent Bridging (IEEE Spanning Tree Protocol)

- WAN Protocols

- Point-to-Point over Ethernet Protocol (PPPoE)

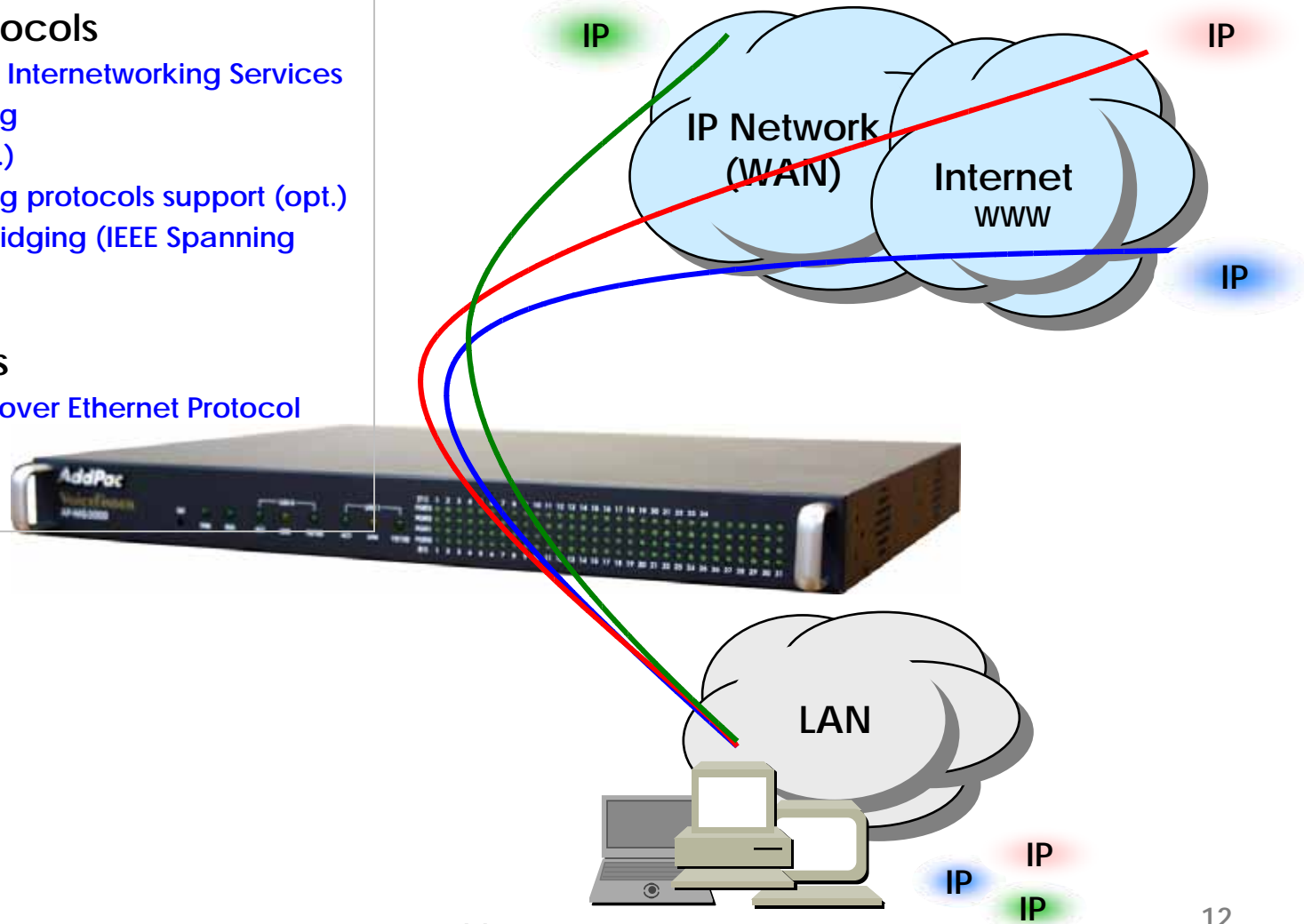

# AP-MG3000 Media Gateway Product Overview

## Network Managements

- **SNMP**
  - Standard Simple Network Management Protocol( SNMP) Agent support
  - MIB v1 and v2 Support
- **Web-based Management**
  - Standard Digital E1/T1 Voice Interface
- **Watch-dog Function**
  - Hardware, Software watch-dog services
- **Remote Management**
  - Telnet
  - Rlogin
  - Console
- **Auto Upgrade Service**
  - HTTP server based APOS image and configuration file auto-upgrade support
- **Batch Job Function**
  - Text based script downloading

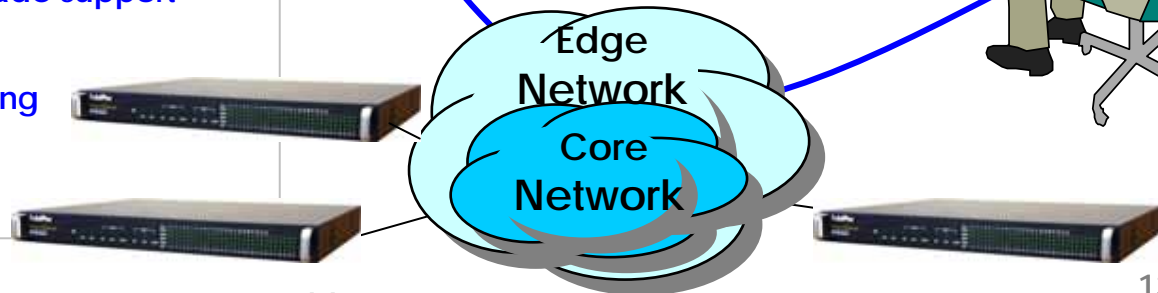
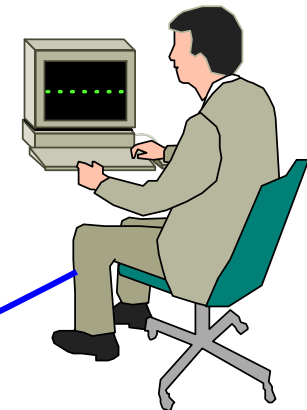

# AP-MG3000 Media Gateway Product Overview

## Security Managements

- IP packet filtering
- IP access list
- User authentication function
  - Password Authentication Protocol (PAP)
  - Challenge Handshake Authentication Protocol (CHAP)
- Enable/Disable specific protocols
- Auto-square connect of console and Telnet session
- Account Management function for multi-level user
- SNMP/TELNET/FTP/HTTP/TFTP port assignment function
- SNMP/TELNET/FTP access list management
- Boot mode security checking function

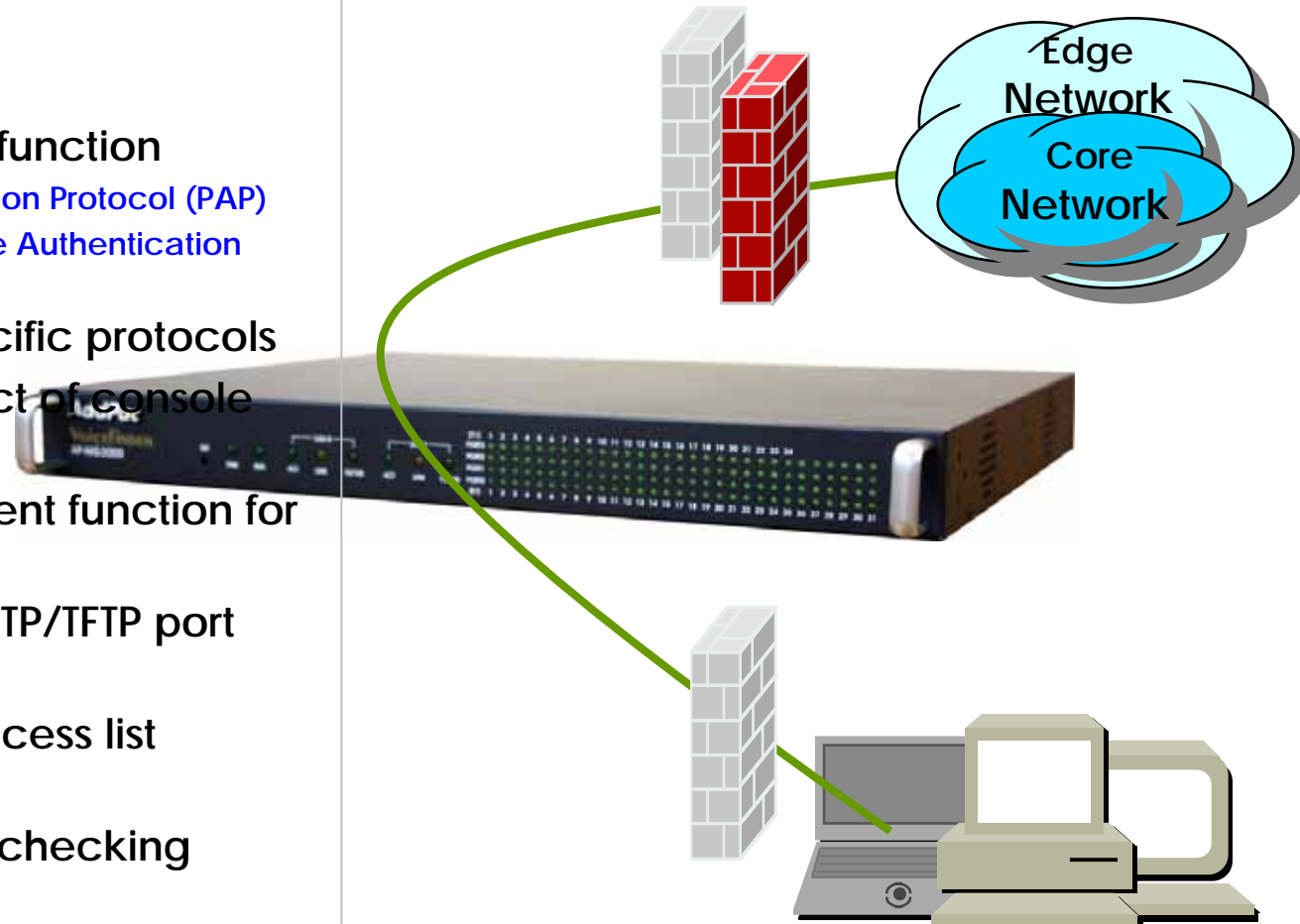

# AP-MG3000 Media Gateway Product Overview

## Network Scalability

- Bridging Service
  - Spanning Tree Bridging protocol (IEEE) support
- DHCP
  - Server and Relay
- IP Accounting
- PAT (Port Address Translation)
- NAT (Network Address Translation)
- Cisco Style CLI (Command Line Interface)
- PPTP (Point-to-Point Tunneling Protocol)
- NTP (Network Time Protocol)
- FTP/TFTP
  - Server and Client support
- DNS
  - Dynamic DNS Client support

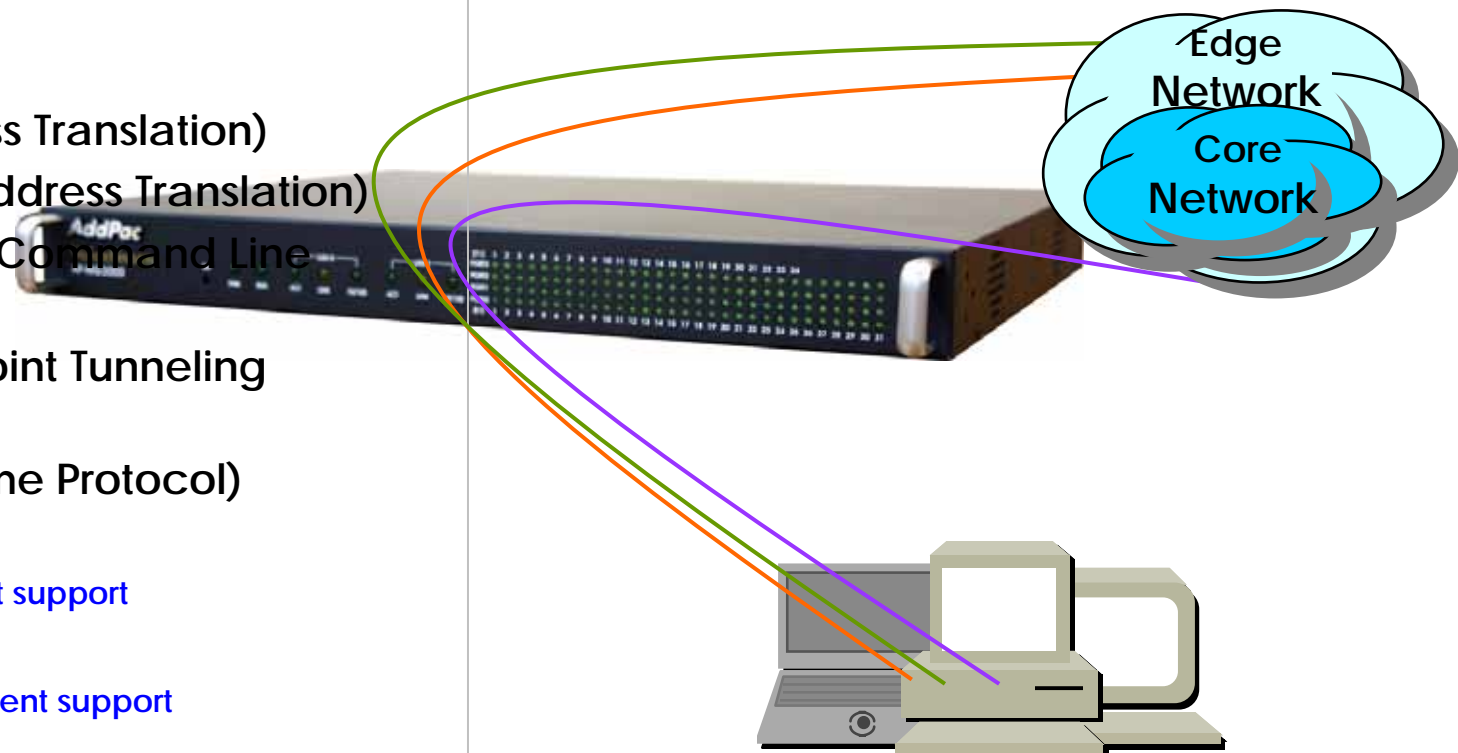

# AP-MG3000 Next Generation Media Gateway

## AP-MG3000 Hardware Specification

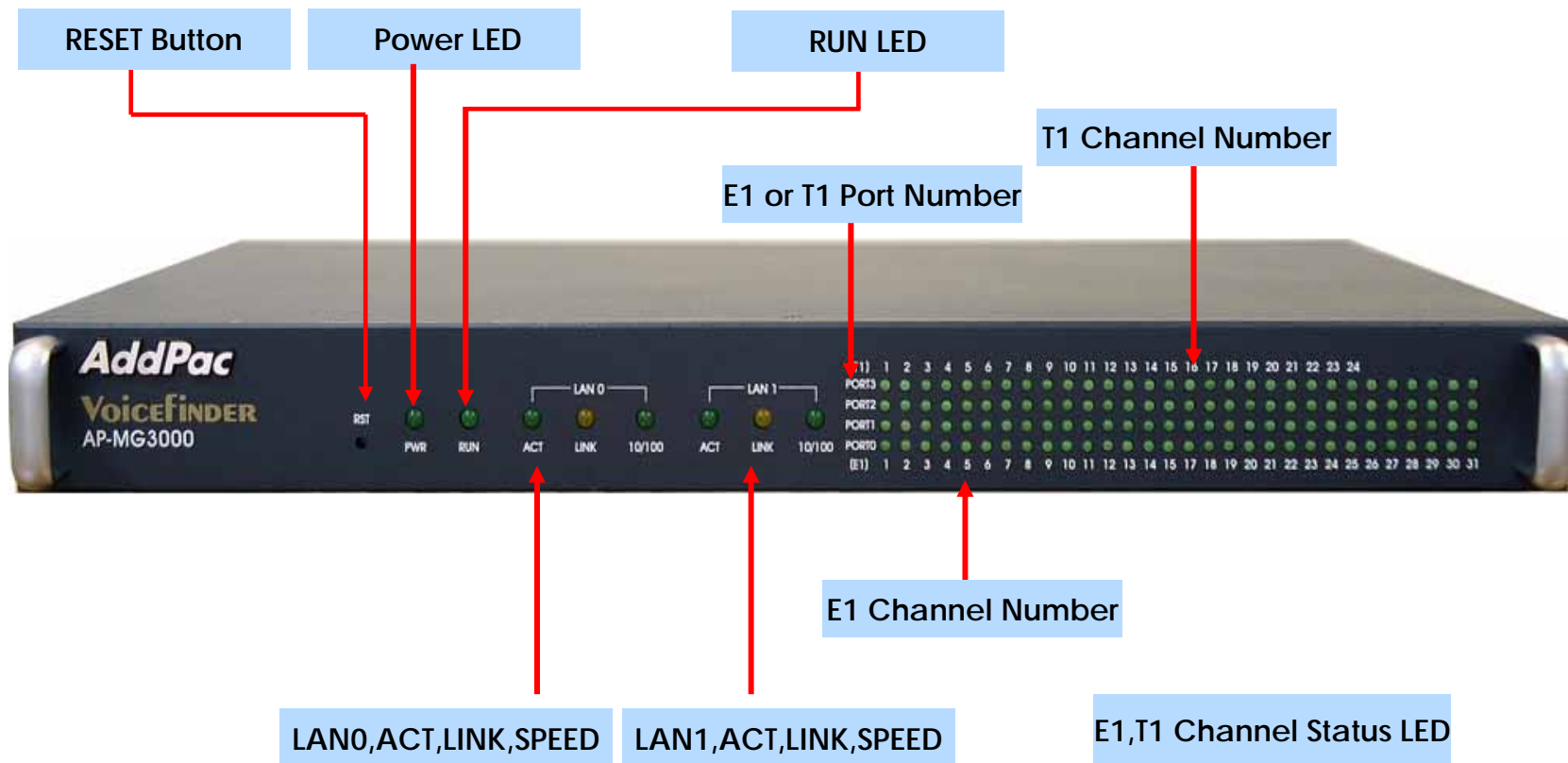



# AP-MG3000 Next Generation Media Gateway

## AP-MG3000 Hardware Specification

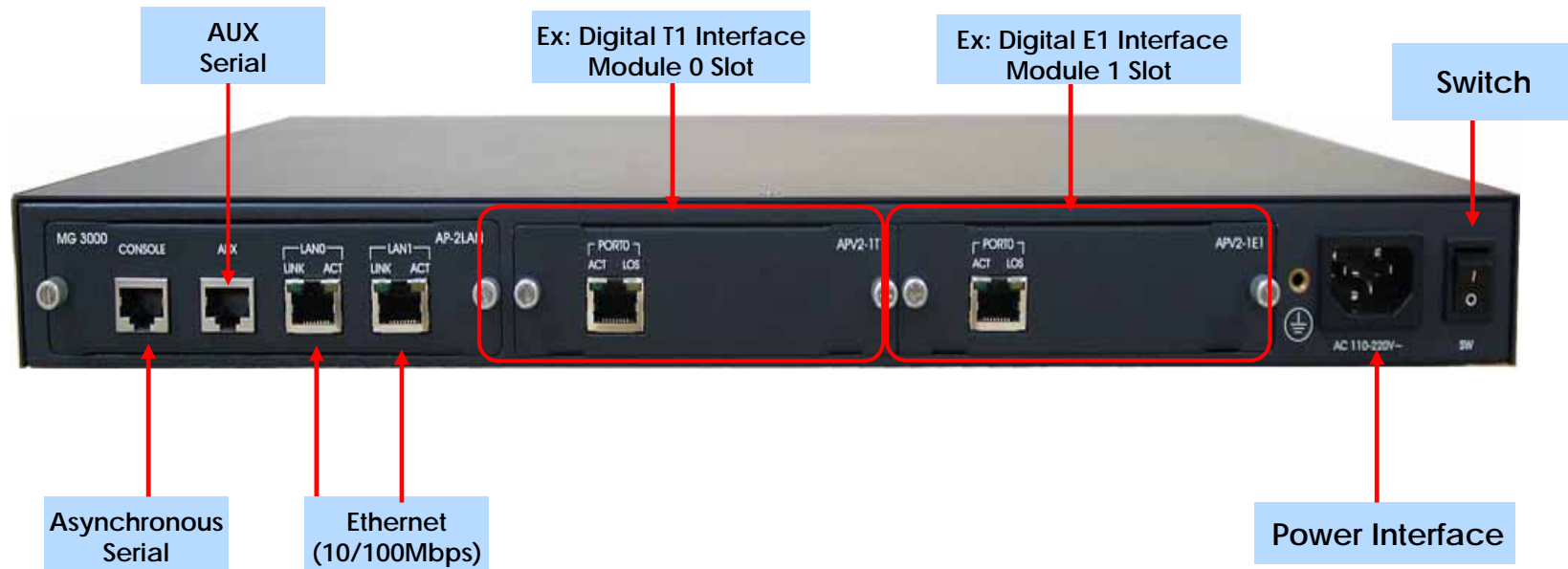

# AP-MG3000 Next Generation Media Gateway

## AP-MG3000 Network Module



AP-2LAN Module

2-Port 10/100Mbps Fast Ethernet Interface

2-Port Asynchronous Serial Interface

# AP-MG3000 Media Gateway Product Overview

## AP-MG3000 Digital Voice Module



MG3000-E1 Module



MG3000-E2 Module



MG3000-E4 Module



MG3000-T1 Module



MG3000-T2 Module



MG3000-T4 Module

# AP-MG3000 Media Gateway Product Overview

## AP-MG3000 Hardware Specification

AP-MG3000 Hardware Specification			
MG3000 Main Board	Processor	64bit High-End Microprocessor	
	Memory	Flash Memory	16Mbyte
		SDRAM	128Mbyte High Speed SDRAM
		Boot Memory	512Kbyte Flash Memory
	Network Interface	Two(2) 10/100M Fast Ethernet Ports	
		1-Port RS-232C Interface for Local System Management(1 x RJ45)	
1-Port RS-232C AUX Port for Modem Interface (1 x RJ45)			
Number of Slot	One(1) Network Module and Two(2) Digital Voice Module Slots		
Digital Voice Module	APV2-E1,T1 : One(1) Port Digital E1,T1 Interface Module		
	APV2-E2,T2 : Two(2) Port Digital E1,T1Interface Module		
	APV2-E4,T4 : Four(4) Port Digital E1,T1 Interface Module		
Power Input	VAC 110~220V Free Voltage, 50/60Hz, 25Watt		
Operating Temperature	0°C ~ 50°C		
Storage Temperature	-40°C ~ 85°C		
Width x Depth x Height	43 x 435 x 205(mm) - 19" Rack Mountable Chassis		
Weight	4.8kg		

# AP-MG3000 Voice Networking Configuration

## VoIP Gateway Appl. (Inter-office calls)

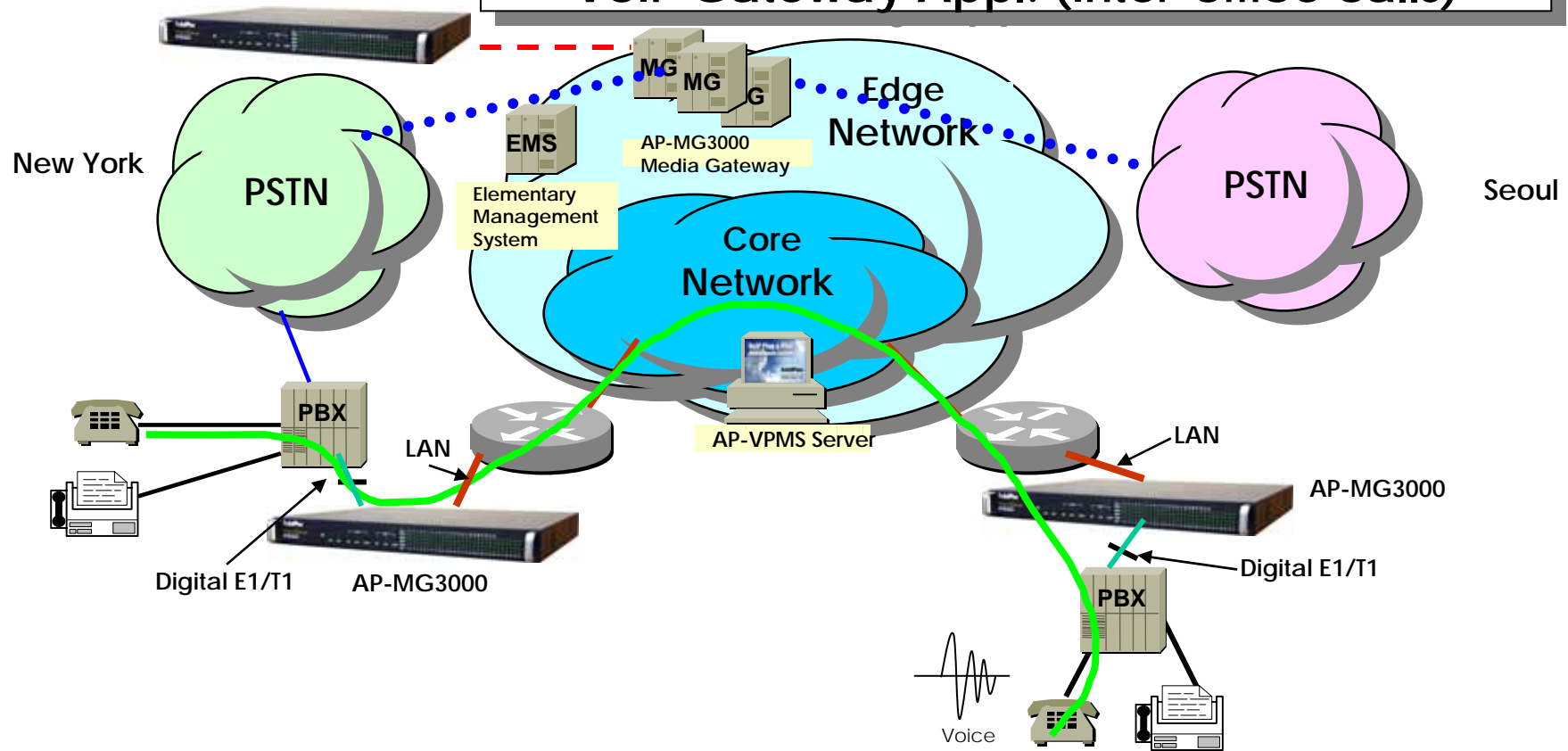

- Voice Call Flow
- PSTN Interface
- Voice+Data, Ethernet or WAN Interface
- TRUNK n x E1 Voice Interface for PSTN Interworking
-  Leased Line/ATM/Frame-Relay/IP Router, xDSL/Cable Modem, etc.
-  AddPac AP-MG3000 Media Gateway
-  Analog Phone

# AP-MG3000 Networking Configuration

## VoIP Gateway Appl.(VoIP to PSTN Inter-working Call Flow)

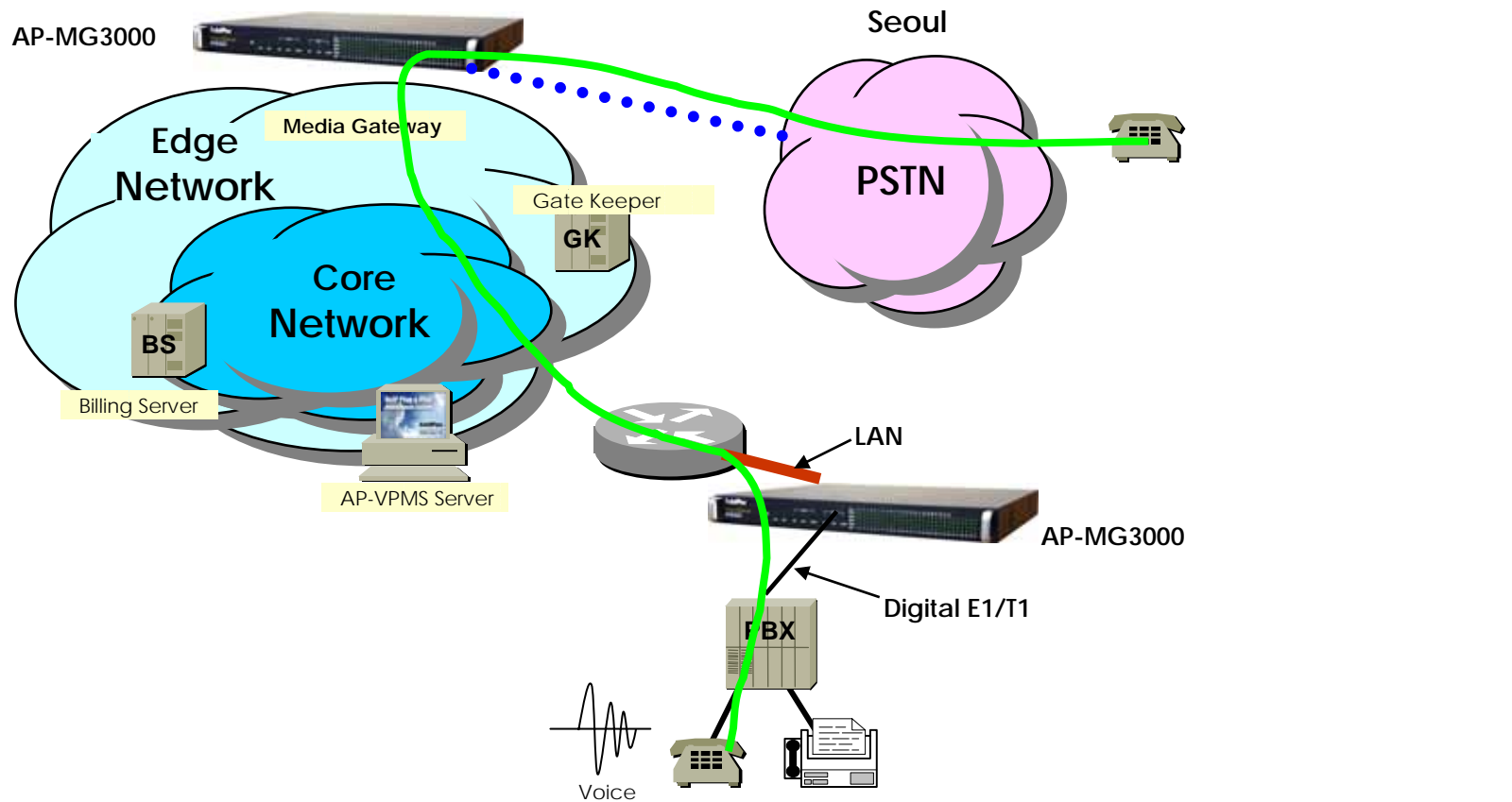

— FXS Analog Voice Interface

— Voice Call Flow

— Voice+Data, Ethernet or WAN Interface

— TRUNK n x E1 Voice Interface for PSTN Interworking

Leased Line/ATM/Frame-Relay/IP Router, xDSL/Cable Modem, etc.

AddPac AP-MG3000 Media Gateway

Analog Phone

# AP-MG3000 Media Gateway Product Overview

## AP-MG3000 Ordering and Pricing

- **AP-MG3000 Media Gateway**

AP-MG5000-01 : AP-MG3000 Standard Configuration

- Two(2) Gigabit Ethernet Interface
- One(1) RJ45 Console Port
- One(1) RJ45 Asynchronous RS-232C Port
- 64bit RISC CPU, 8MB Flash, 64MB SDRAM
- APOS v5.xx with Operation Manual
- Including CAB-LAN, CAB-CON



MG3000-E1 : 1 Port Digital E1 Interface Module

MG3000-T1 : 1 Port Digital T1 Interface Module

MG3000-2E1 : 2 Port Digital E1 Interface Module

MG3000-2T1 : 2 Port Digital T1 Interface Module

MG3000-4E1 : 4 Port Digital E1 Interface Module

MG3000-4T1 : 4 Port Digital T1 Interface Module

CAB-LAN :RJ45 Ethernet Cable

CAB-CON :RJ45 RS-232C Console Cable

# AP-MG3000 Media Gateway Product Overview

## AP-MG3000 Comparison Table

	<p style="text-align: center;">AP-MG3000 Media Gateway</p>
<p>▶ Digital Voice Interface Modules</p>	<p style="text-align: center;">Up to 2</p>
<p>▶ Asynchronous Port</p>	<p style="text-align: center;">1</p>
<p>▶ 10/100 Mbps Ethernet Ports</p>	<p style="text-align: center;">2</p>
<p>▶ Console Port</p>	<p style="text-align: center;">1</p>
<p>▶ Main CPU</p>	<p style="text-align: center;">High-End Power PC 64Bit RISC</p>
<p>▶ Main Flash Memory</p>	<p style="text-align: center;">8Mbyte</p>
<p>▶ Main Memory</p>	<p style="text-align: center;">64Mbyte</p>
<p>▶ Internetworking OS</p>	<p style="text-align: center;">APOS</p>
<p>▶ H.323, SIP, MGCP VoIP Protocol, T38 FAX</p>	<p style="text-align: center;">YES</p>
<p>▶ PPPoE, PPTP Network Protocols</p>	<p style="text-align: center;">YES</p>
<p>▶ Enhanced QoS Management Feature</p>	<p style="text-align: center;">YES</p>
<p>▶ IP Routing Protocols Including NAT</p>	<p style="text-align: center;">YES</p>



Thank you !

[www.addpac.com](http://www.addpac.com)