



# AP-VP350

## BcN Video Phone

High Performance Broadband Convergence Network  
MCU Video Phone Solution



# **AddPac**

**AddPac Technology**

Sales and Marketing

[www.addpac.com](http://www.addpac.com)

# High Quality, High Resolution

AP-VP350 Video Phone



**AddPac**

[www.addpac.com](http://www.addpac.com)

# High Quality, High Resolution

AP-VP350 Video Phone



**AddPac**

[www.addpac.com](http://www.addpac.com)

# Contents

## AP-VP350 Video Phone

- Product Overview
- Benefits and Features
- Hardware Specification
- Multimedia Service
- Software Service
- Video Service & Features
- Built-In MCU Service & Features
- Dual Monitor Service & Features
- Audio & Voice Service and Features
- Network Service and Features
- OSD Software Features
- Application Area
- Ordering Information



# Product Overview

## AP-VP350 Video Phone

- IP based Video Phone Solution
- Built-In MCU (4-Party Conference)
- Dual Monitor & Dual Monitor Emulation
- Document Sharing with PC Software
- VoD (Video on Demand) Service
- IPTV Service
- Network Surveillance Service
- High-performance Video, Audio, and Voice Service
- Flexible Videoconferencing Deployment
- Firmware Upgradeable Architecture
- Video Solution with Outstanding Network Service Capability
- Audio/Video Privacy Protection





# Product Highlights

## AP-VP350 Video Phone

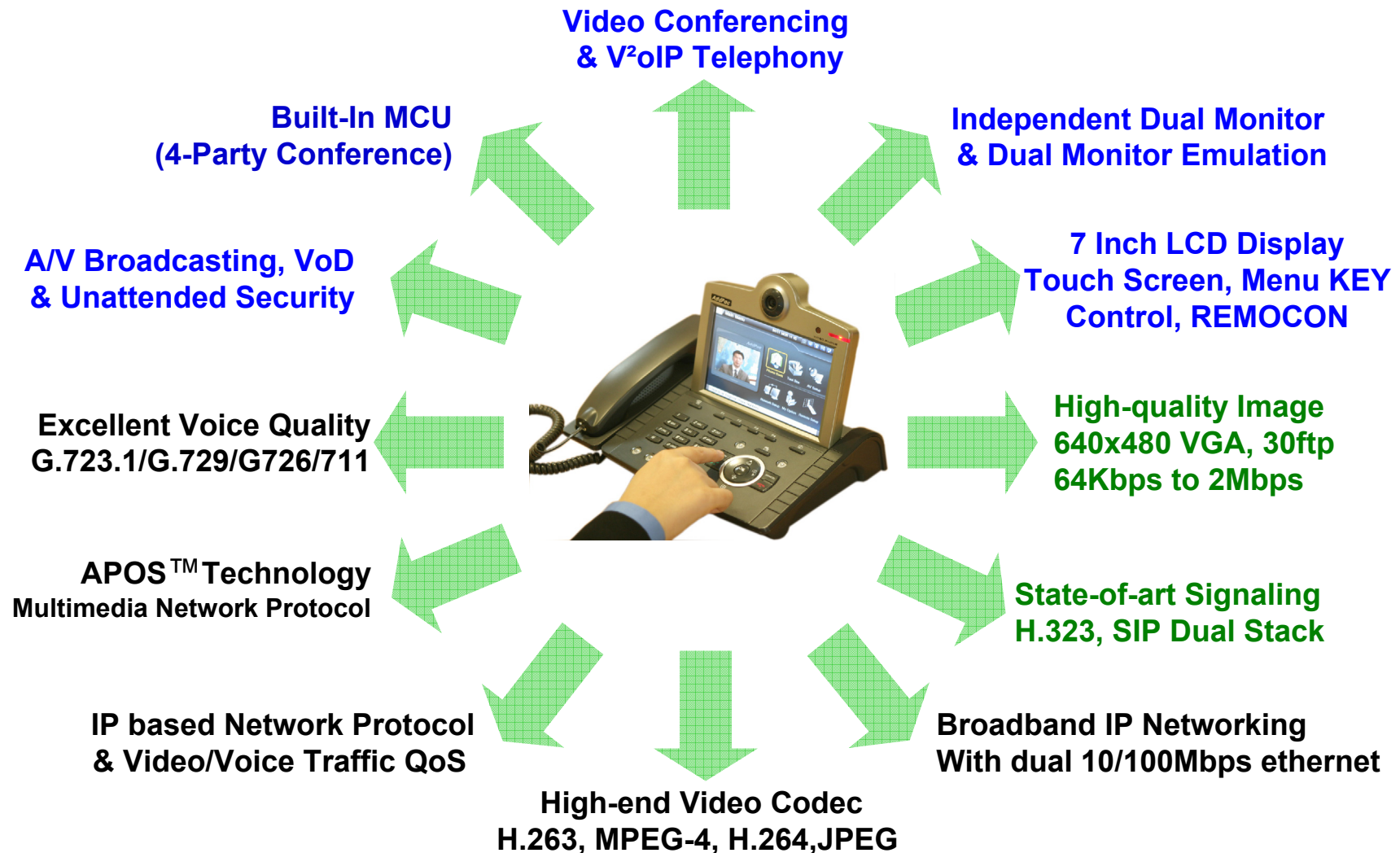

# Multimedia Service

AP-VP350 Video Phone

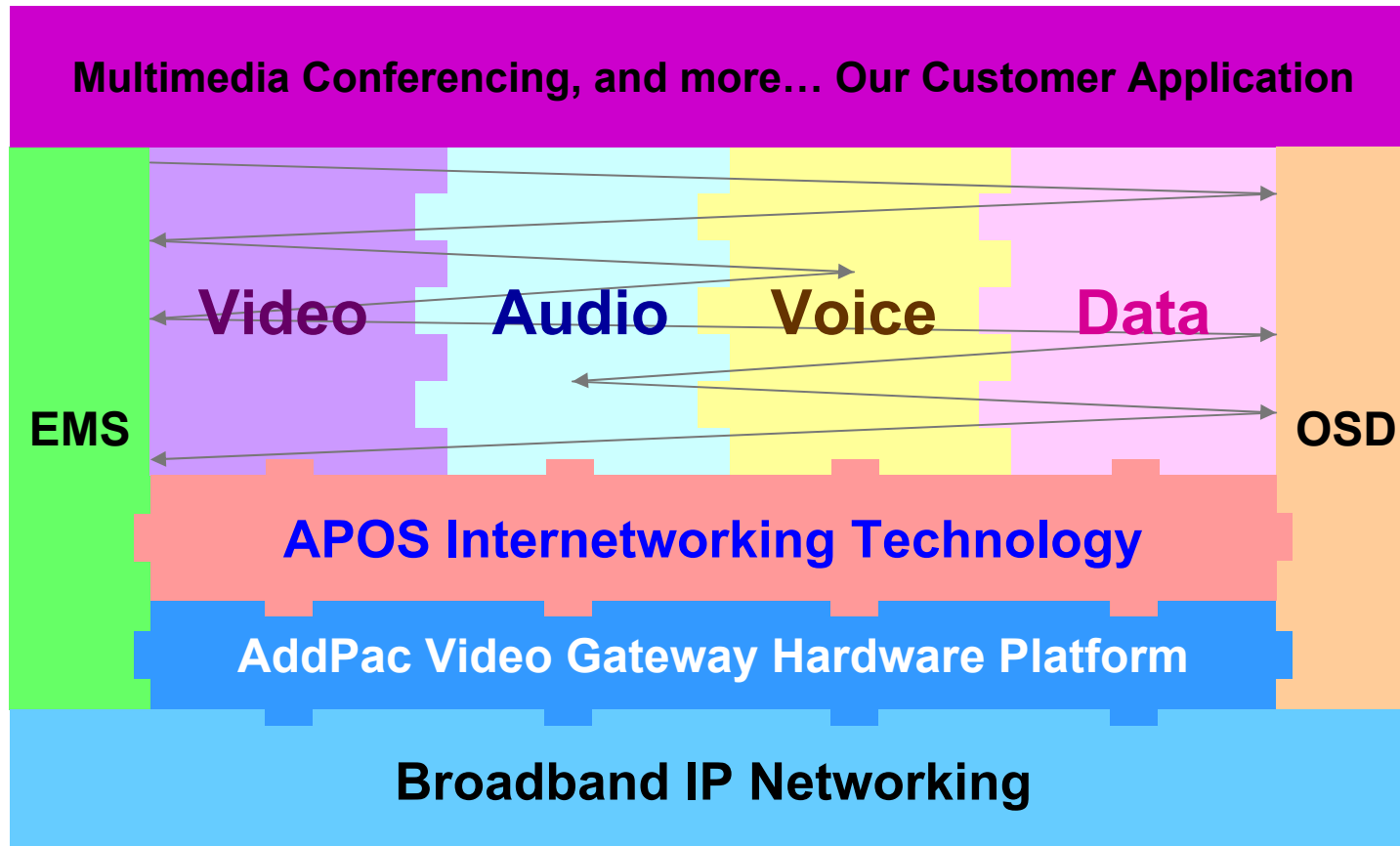

- APOS : AddPac Internetworking Operating System
- OSD : On- Screen Display
- EMS : Element Management System

# Benefits and Features

## AP-VP350 Video Phone

- **7 Inch LCD Display, Touch Screen, RemoCon**
- **External Video Interface**
  - Composite (RCA) Video In/Out, S-Video Out
  - Audio (RCA) In/Out
- **High-performance Video Codec Support**
  - H.263, MPEG-4, JPEG, and H.264
- **Powerful Image Resolution Support**
  - QCIF(176x144), CIF(352x288), QVGA(320x240), and VGA(640x480)
- **Up to 30fps at 1Mbps with VGA-Resolution(MPEG-4)**
- **Built-In MCU for Video Conference (4-Party Conference)**
- **Independent Dual Monitor & Dual Monitor Emulation**
- **Document Sharing with PC Software**
- **SIP, H.323 Signaling Support**
- **Rate Control for Video Traffic QoS**
- **High-end Error Resilient Against Various Packet Error**





# Hardware Specification

## AP-VP350 Video Phone

64bit  
CPU

High-end  
DSP

- **RISC Microprocessor Computing Power**
- **High-end Programmable DSP Hardware Architecture**
- **Powerful Video Interface**
  - RCA Video Input/Output, S-Video Output
- **High quality Audio and Voice Interface**
  - Stereo Audio Input Connector
  - Stereo Audio Output Connector
- **Network Interface**
  - Two(2) 10/100Mbps Fast Ethernet
  - One(1) RS-232C Console
  - One(1) USB 1.0 Interface
  - PSTN FXO Interface



**AddPac**

[www.addpac.com](http://www.addpac.com)

# Software Service

## AP-VP350 Video Phone

- **Built-in AddPac APOS Internetworking Software**
  - Scalability, Functionality, and Stability Features
  - Video Traffic QoS Control
- **Programmable Video, Audio, and Voice Services**
  - Video Codes, Audio, and Voice Codec
- **Firmware Upgradeable DSP Architecture**
- **OSD (On-screen Display) Function Support**
- **Industry Standard IP based Network Protocol Features**

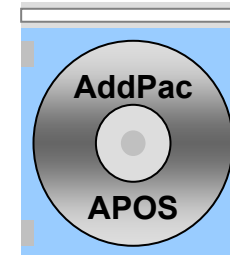

# Video Service and Features

## AP-VP350 Video Phone

- **Various Video Networking Interface**
  - Composite (RCA), S-Video
- **High-performance Video Codec Support**
  - H.263, MPEG-4, JPEG, and H.264
- **Powerful Image Resolution Support**
  - QCIF(176x144), CIF(352x288), QVGA(320x240), and VGA(640x480)
- **Up to 30fps at 1Mbps with VGA-Resolution(MPEG-4)**
- **64Kbps to 2Mbps Operating Video Traffic Bandwidth**
- **Rate Control for Video Traffic QoS**
  - Ensuring Optimized Quality
  - Frame Rate with Limited Bandwidth
- **High-end Error Resilient Against Various Packet Error**

# Built-In MCU Service and Features

## AP-VP350 Video Phone

- **Single Codec : H.263 or MPEG4**
- **4-Party Video Conference**
- **Single Rate Control**
- **Asymmetric Rate Control between Encoder & Decoder**
- **Same Conference Layout for All Party**

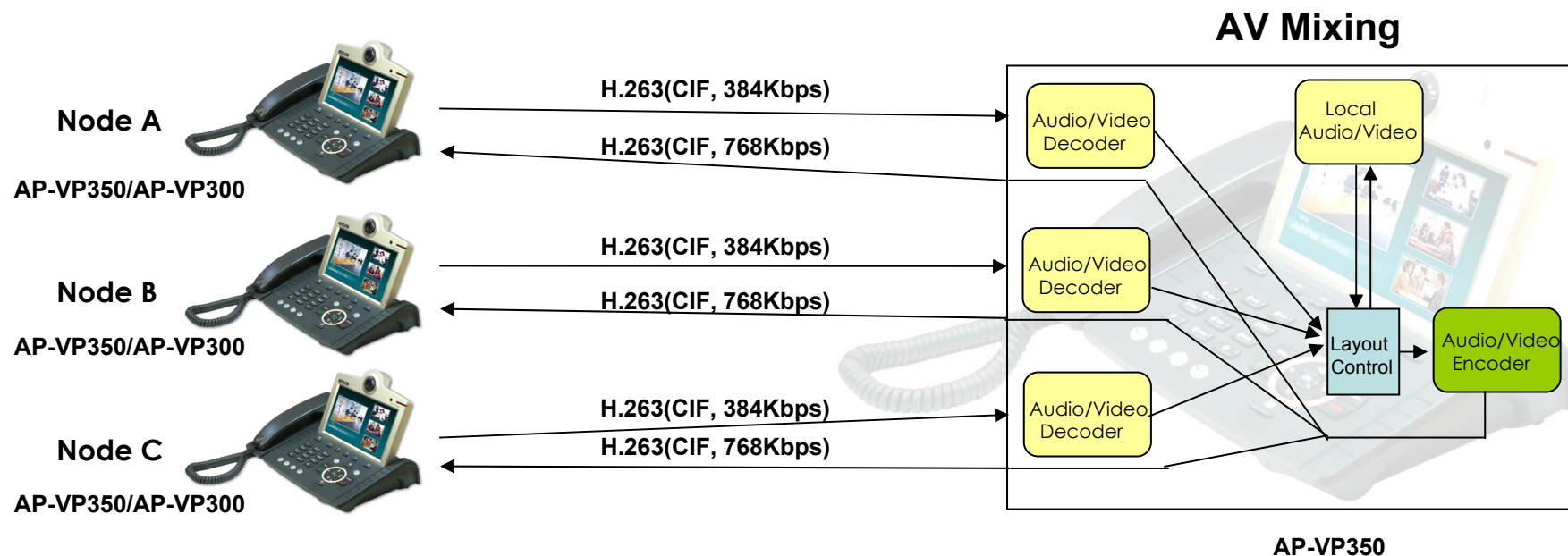

# Dual Monitor Emulation Service

## AP-VP350 Video Phone

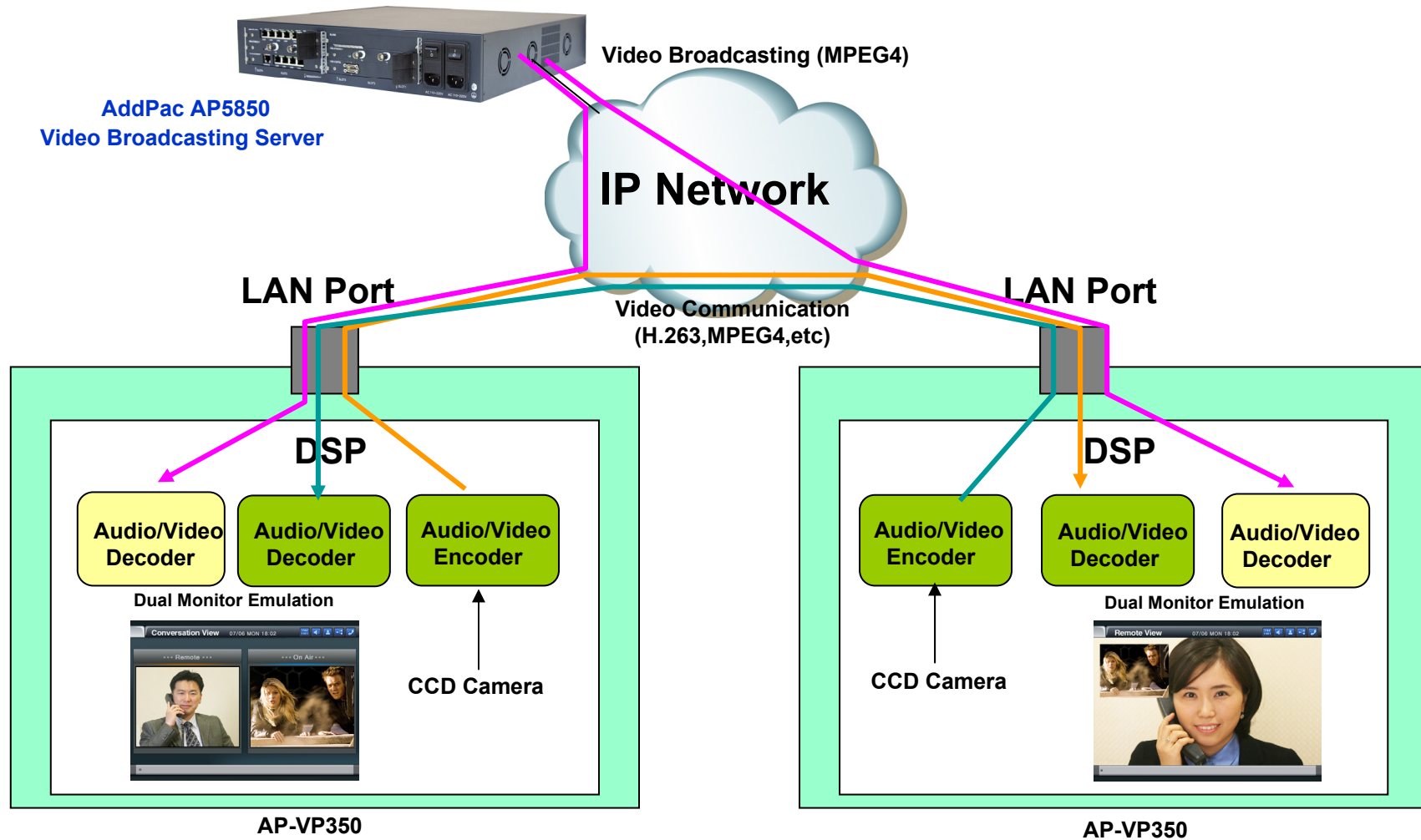

# Dual Monitor Service and Features

## AP-VP350 Video Phone

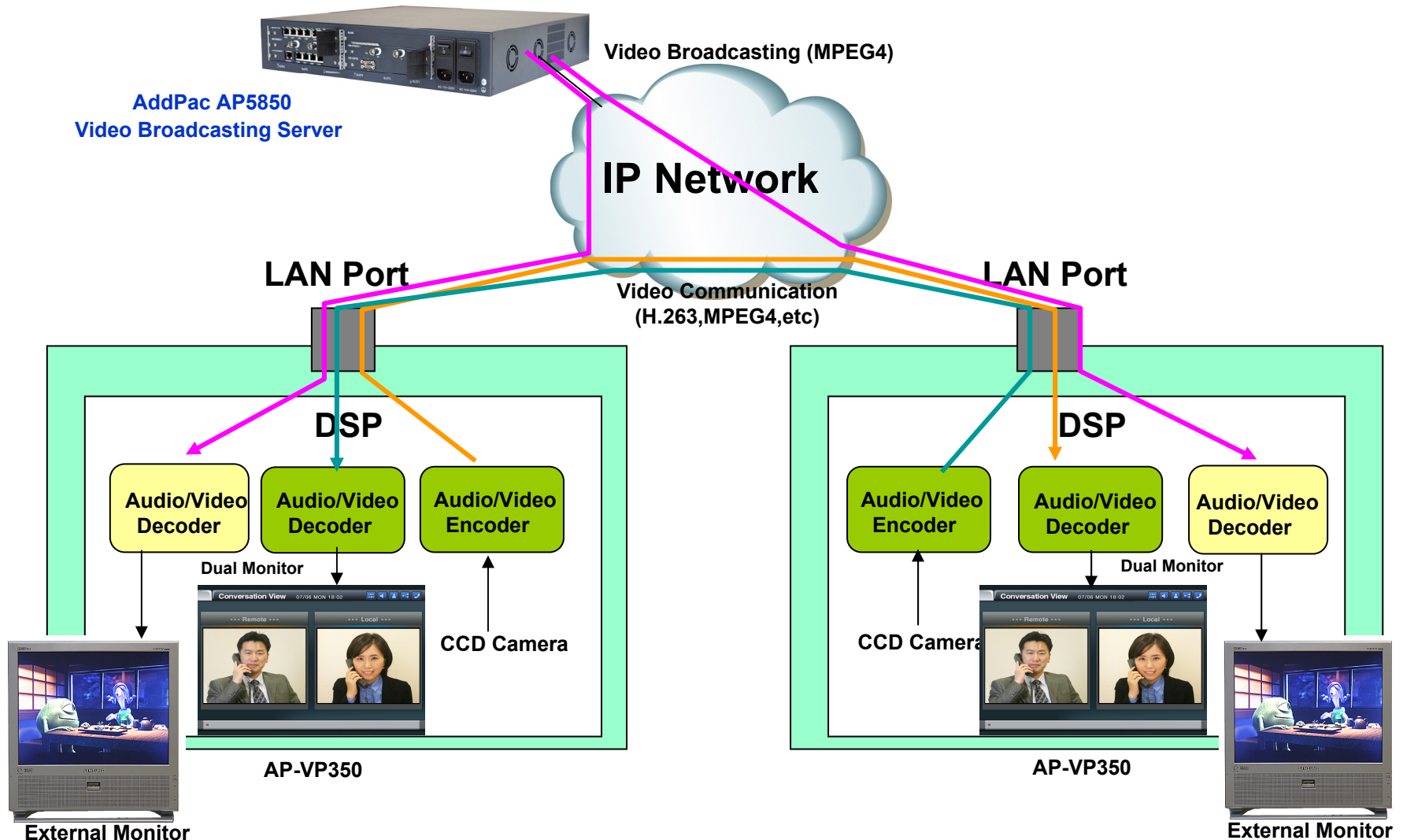



# Audio & Voice Service and Features

## AP-VP350 Video Phone

- **Audio & Voice Networking Interface**
  - Audio Input/Output Port (2 x 3.5mm Stereo Female Connector)
- **VoIP based Signaling Protocol Support**
  - H.323, SIP Multiple Signaling Protocol Stack
  - H.323 Gateway, Gatekeeper Support
- **High-performance Audio & Voice Codec Support**
  - Line IN/OUT : G.726, G.711 Audio Codec, etc
- **Enhanced QoS Management Features for Voice Traffics**

# Network Service and Features

## AP-VG350 Video Phone

- **Network Managements**
  - Standard SNMP Agent (MIB v2) Support
  - Remote Management using Console, Telnet
  - Web based Management using HTTP Server Interface
- **Security Functions**
  - Standard & Extended IP Access List
  - Enable/Disable for Specific Network Protocols
  - Multi-level User Account Management
  - Auto-disconnect for Telnet/Console Sessions
  - PPP User Authentication Supports (PAP & CHAP)
- **Operation & Managements**
  - System Performance Analysis for Process, CPU, Connection Interface
  - Debugging, System Auditing, and Diagnostics Support
  - System Booting and Auto-rebooting with Watchdog Feature
  - System Managements with Data Logging
  - IP Traffic Statistics with Accounting

# Network Service and Features

## AP-VP350 Video Phone

- **Network Managements**
  - DHCP Server & Relay Functions
  - Network Address Translation (NAT) Function
  - Port Address Translation (PAT) Function
  - Transparent Bridging (IEEE Standard) Function
    - Spanning Tree Bridging Protocol Support
    - Remote Bridging Support
    - Concurrent Routing and Bridging Support
  - Cisco Style Command Line Interface (CLI)
  - Network time Protocol (NTP) Support

# OSD Software Features

AP-VP350 Video Phone OSD Service

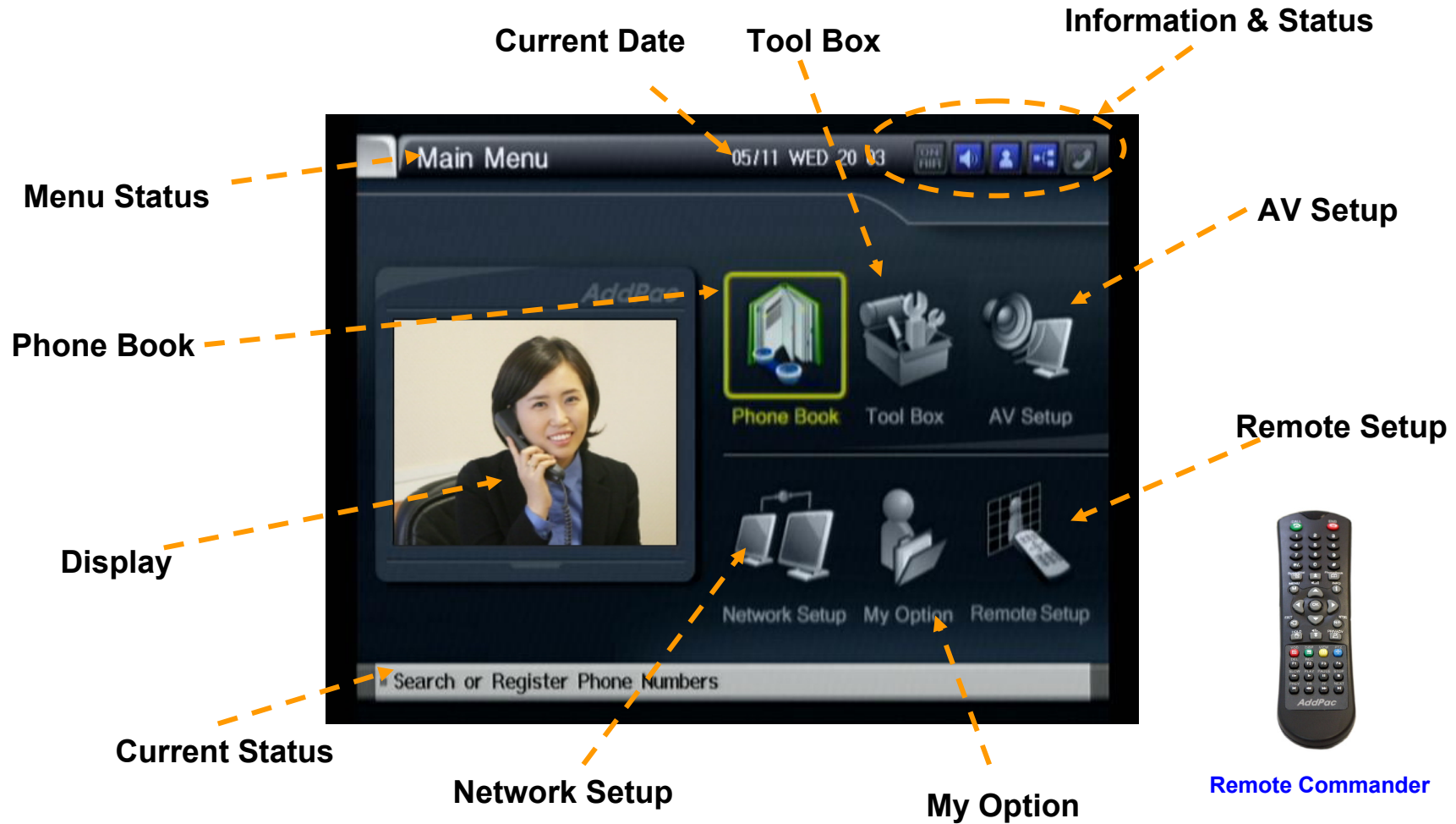

# OSD Software Features

## AP-VP350 Video Phone OSD Service



# OSD Software Features

## AP-VP350 Video Phone OSD Service



Remote Commander

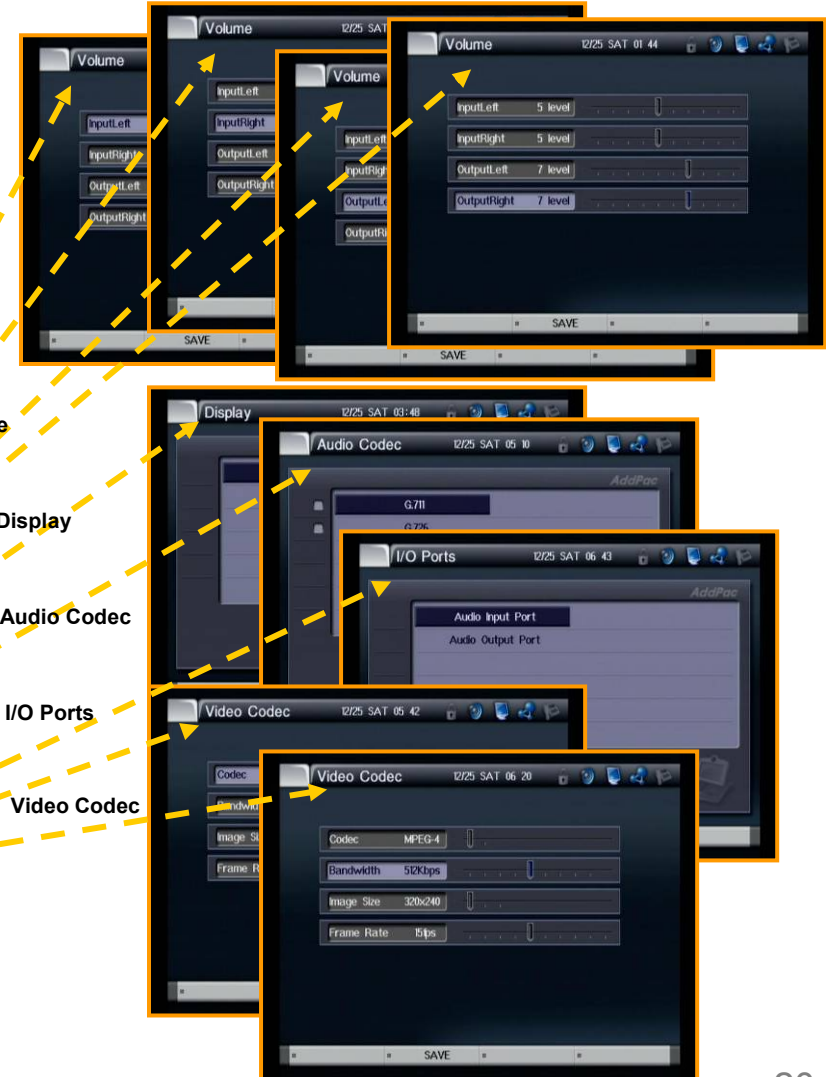



# OSD Software Features

## AP-VP350 Video Phone OSD Service

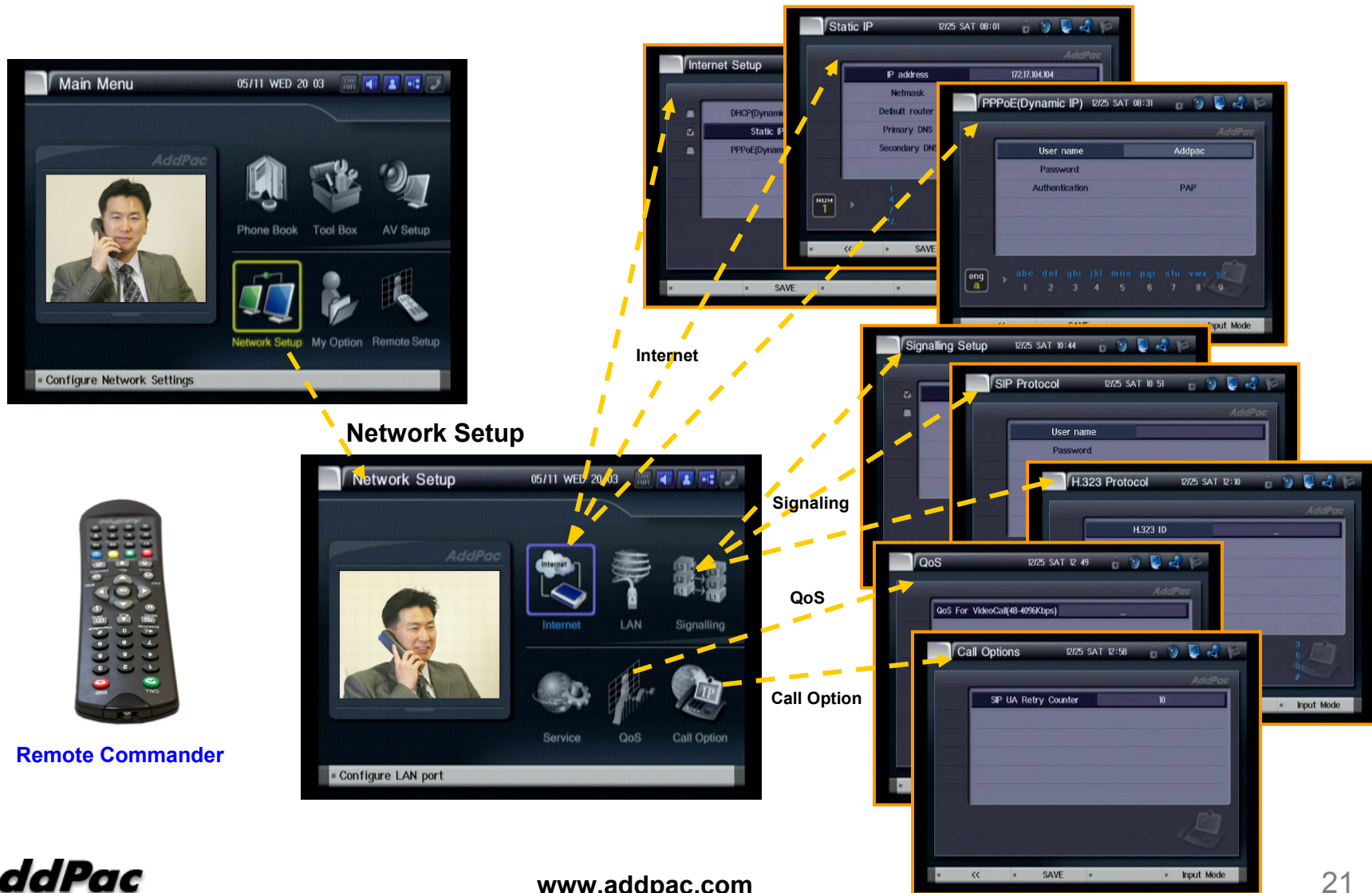

# AP-VP350 Video Phone

## Application Area

- IP-PBX Video Terminal
- Audio/Video Real-time Broadcasting
- Video on Demand Application
- IPTV Application for Enterprise
- Unattended Surveillance
- Video Telephony
- Video Conference
- Dual Monitor
- Document Sharing



# Standard IP-PBX Application

## AP-VP350 Video Phone

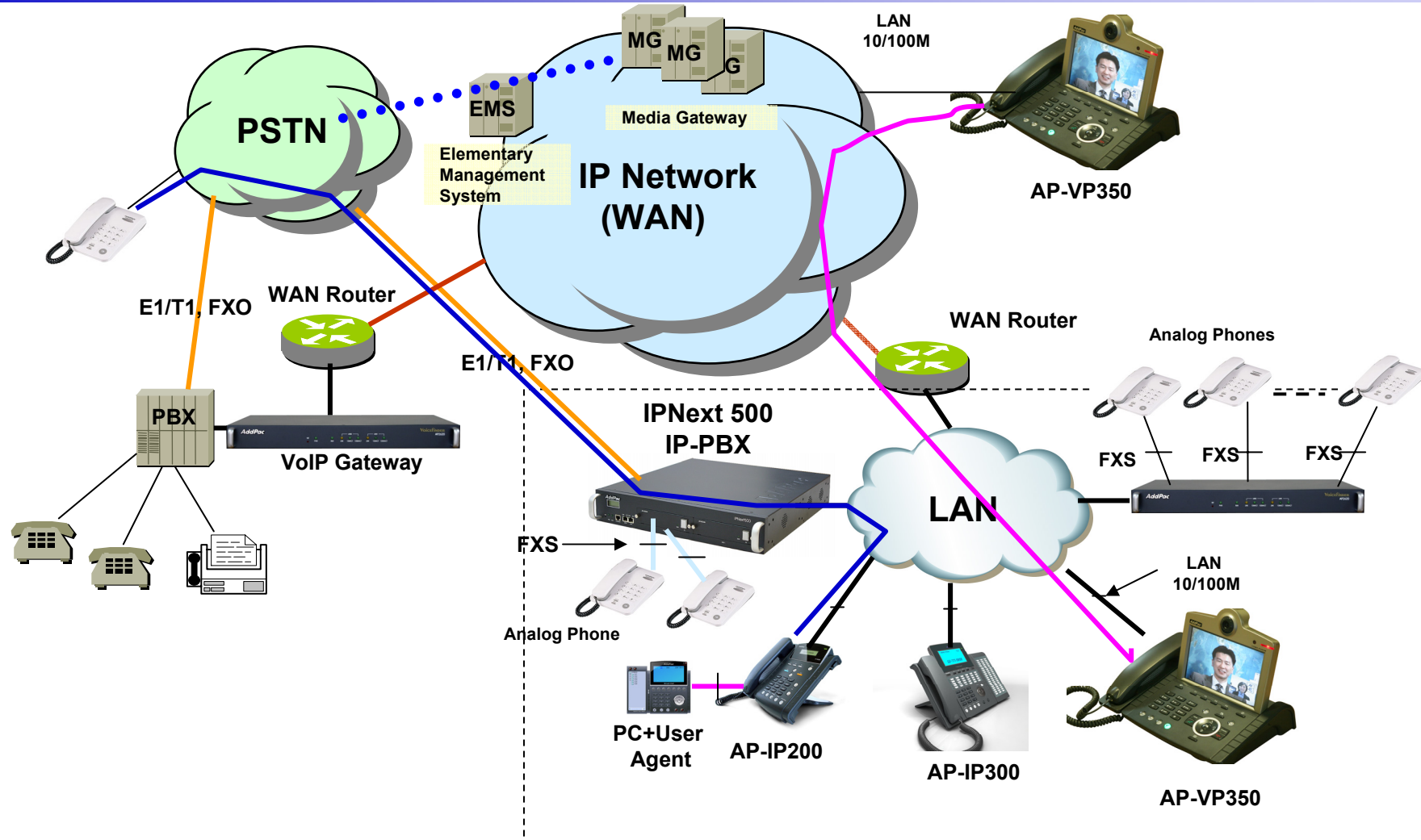

# Video on Demand Service

## AP-VP350 Video Phone

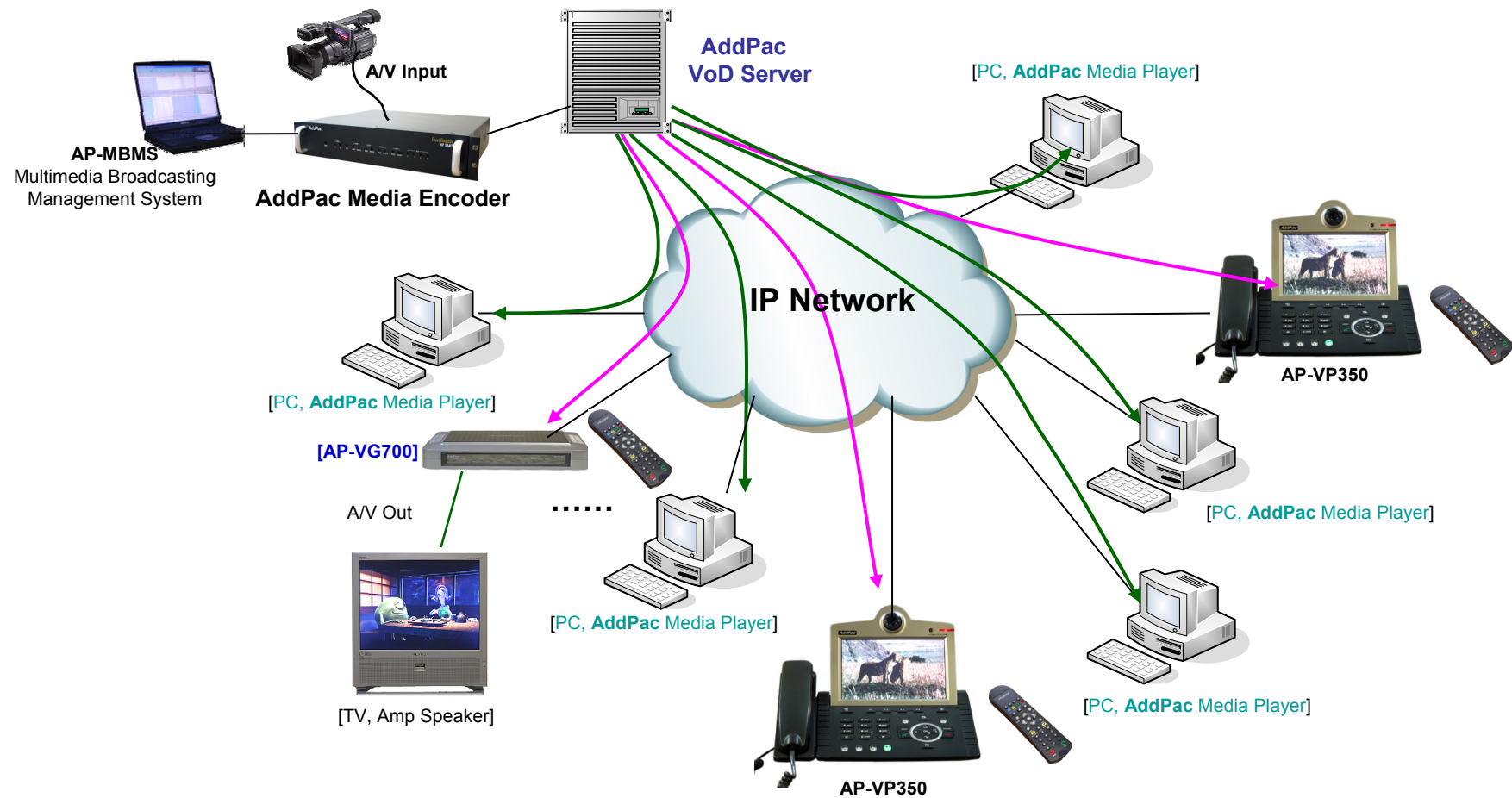

# Video Telephony Application

## AP-VP350 Video Phone

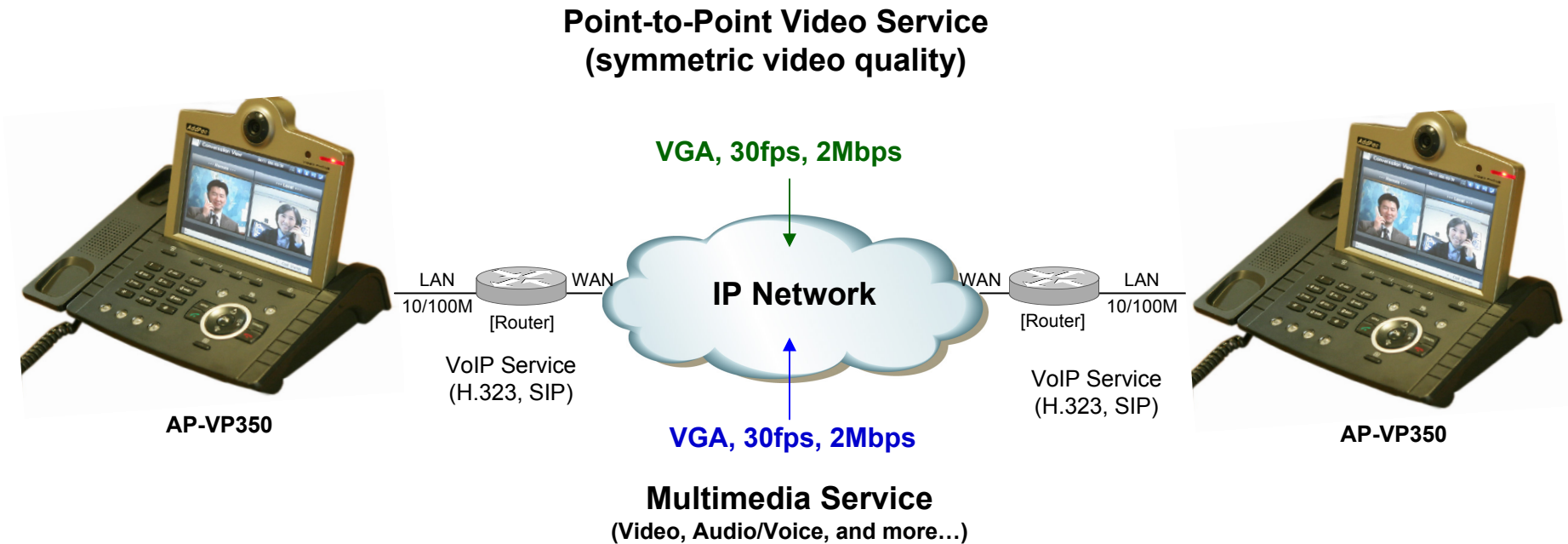



# Video Conference

## AP-VP350 Video Phone

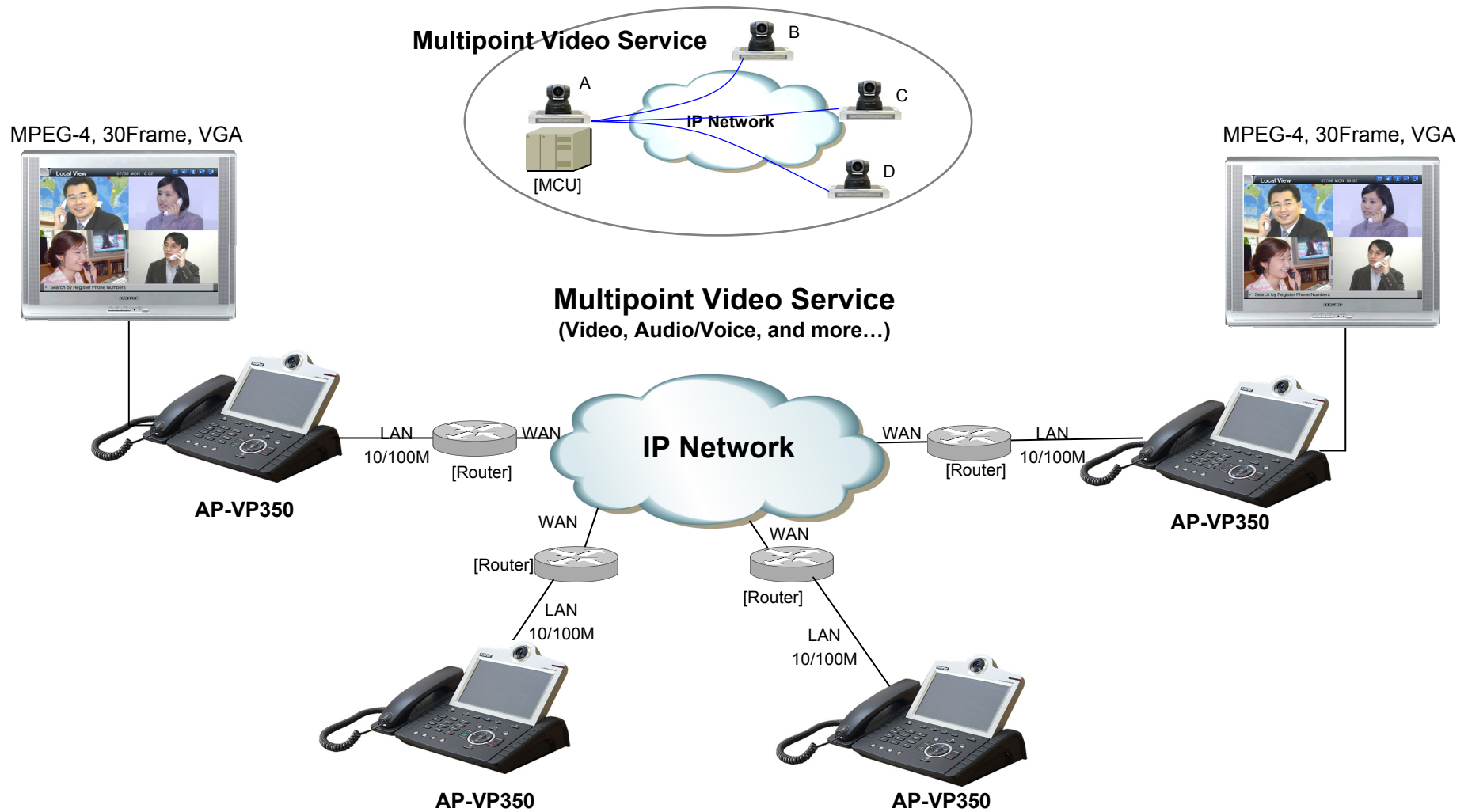



# Dual Monitor

AP-VP350 Video Phone



# Remocon Specification

## AP-VP350 Video Gateway

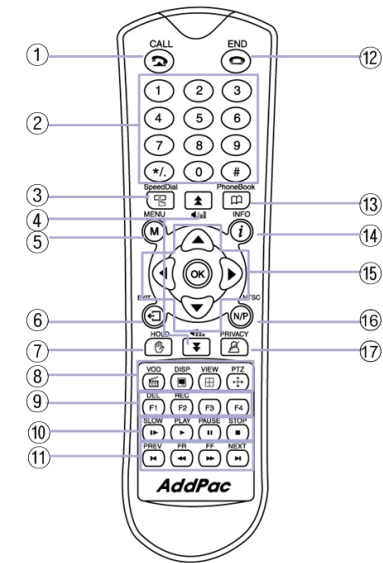

Remote Commander

### Remote Control

No	Function	No	Function
1	CALL/Recent Call	10	SLOW PLAY, PLAY, PAUSE, STOP
2	Keypad	11	PREVIOUS, FAST REWARD, FAST FORWARD, NEXT
3	SpeedDial	12	END
4	Zoom In/Out, Volume	13	PhoneBook
5	MENU	14	INFO
6	EXIT	15	ARROW KEY
7	HOLD	16	NTSC/PAL
8	VOD, DISPLAY, VIEW Mode, PAN/TILT	17	PRIVACY
9	DEL, REC, MIRROR, Call Status		

# Ordering Information

- **AP-VP350 Video Phone Hardware**
  - AP-VP350 Video Phone Main Body
  - RISC Microprocessor with High-end Programmable DSP Architecture
  - 7 Inch LCD, Built In Camera, Touch Screen, Remote Controller
  - External Video RCA Input/Output, S-Video Out and 3.5mm Audio Input/Output
  - 2-ports 10/100Mbps Fast Ethernet and 1-port RS-232C Console
  - Including Network Cable Set & Ext. Power Supply, etc.
- **Built-in APOS Internetworking Software for AP-VP350**
- **Including 1 Year Hardware Warranty**
- **Product Documents**
  - Install and Operation Guide (PDF)
- **Pricing**
  - AddPac Technology Regional Sales Manager
  - Authorized Sales and Marketing Representatives
  - Please Contact [www.addpac.com](http://www.addpac.com)

# AP-VP350 Video Phone

Thank you!

**AddPac Technology Co., Ltd.**  
Sales and Marketing

Phone +82.2.568.3848 (KOREA)

FAX +82.2.568.3847 (KOREA)

E-mail [sales@addpac.com](mailto:sales@addpac.com)