

# RoIP (Radio over IP ) Solution



**Radio over IP Solution**

- IPNext2000 IP-PBX
- AP-PTS3000 PTT Server
- AP-LMR2000 LMR Gateway
- AP-LMR1000 LMR Gateway
- AP-IP300 IP Phone
- AP-IP230 IP Phone

[Learn More >](#)

The advertisement features a collection of hardware components including two IP phones, a mobile radio, a PTT server, two LMR gateways, and a server rack, all set against a blue gradient background.

***AddPac***

**AddPac Technology**

Sales and Marketing

[www.addpac.com](http://www.addpac.com)

# Contents

- AddPac RoIP Solution
- RoIP Network Diagram
- RoIP Service Examples
- RoIP Call Scenario
- RoIP System Message Flow
- RoIP Solution Components
  - IPNext2000 IP-PBX
  - AP-PTS3000 PTT Server
  - LMR (Land-to-Mobile Radio) Gateways for RoIP Service
  - IP Phones for RoIP Service
  - SMM(Smart Multimedia Manager) for RoIP Solution
  - NMS(Network Management System ) for RoIP Solution

# AddPac RoIP Solution

- LMR system overview
  - A LMR(Land Mobile Radio) system is a collection of portable and stationary radio units designed to communicate with each other.
  - LMR is deployed wherever organizations need to have instant communication between geographically dispersed and mobile personnel.
  - Typical LMR system users are public safety organizations (ex: police departments, fire departments, etc).
  - The systems are extended the range of communications by repeaters.
  - The systems are required interoperability with IP network.

# AddPac RoIP Solution

- AddPac RoIP Solution Features
  - LMR Gateway(AP-LMR2000) joins the LMR systems to the IP network through open SIP standard and RTP.
  - The radios are connected to LMR gateway through AddPac radio interface (reference LMR signal).
  - AddPac IP PTT terminals (AP-IP230, AP-IP300 IP Phones, AP-WP100 WiFi-Phone, etc) support the traditional radio user interface(PTT).
  - AddPac IP PTT terminals easy PTT group management user interface.
  - IP-PBX support call management, PTT group management, PTT control and various additional service.
  - PTT Server(AP-PTS3000) support powerful media data relay, broadcasting, multicasting and PTT group management.
  - RoIP Solution supports emergency and group PTT service.

# RoIP Network Diagram (1/2)

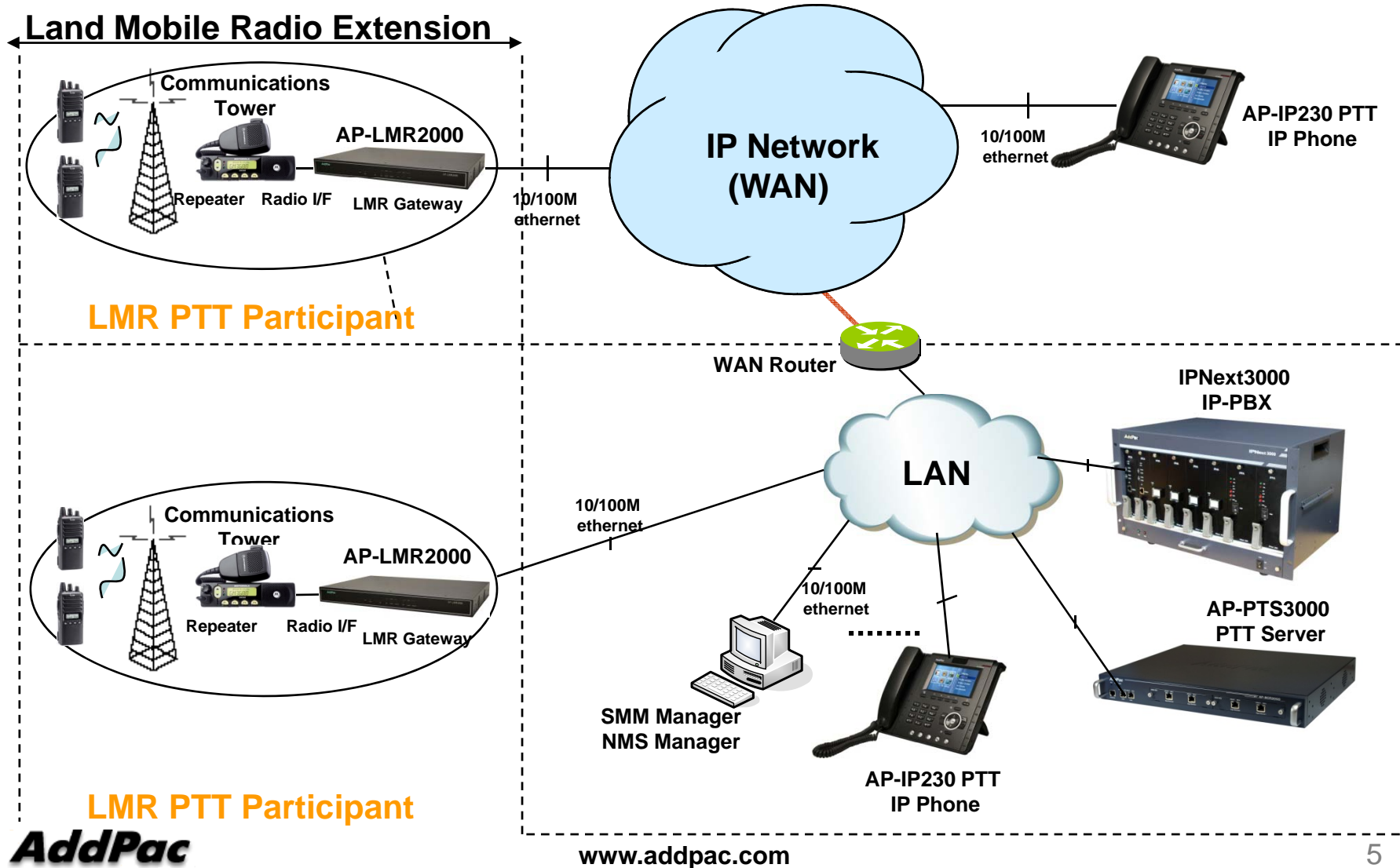

# RoIP Network Diagram(2/2)

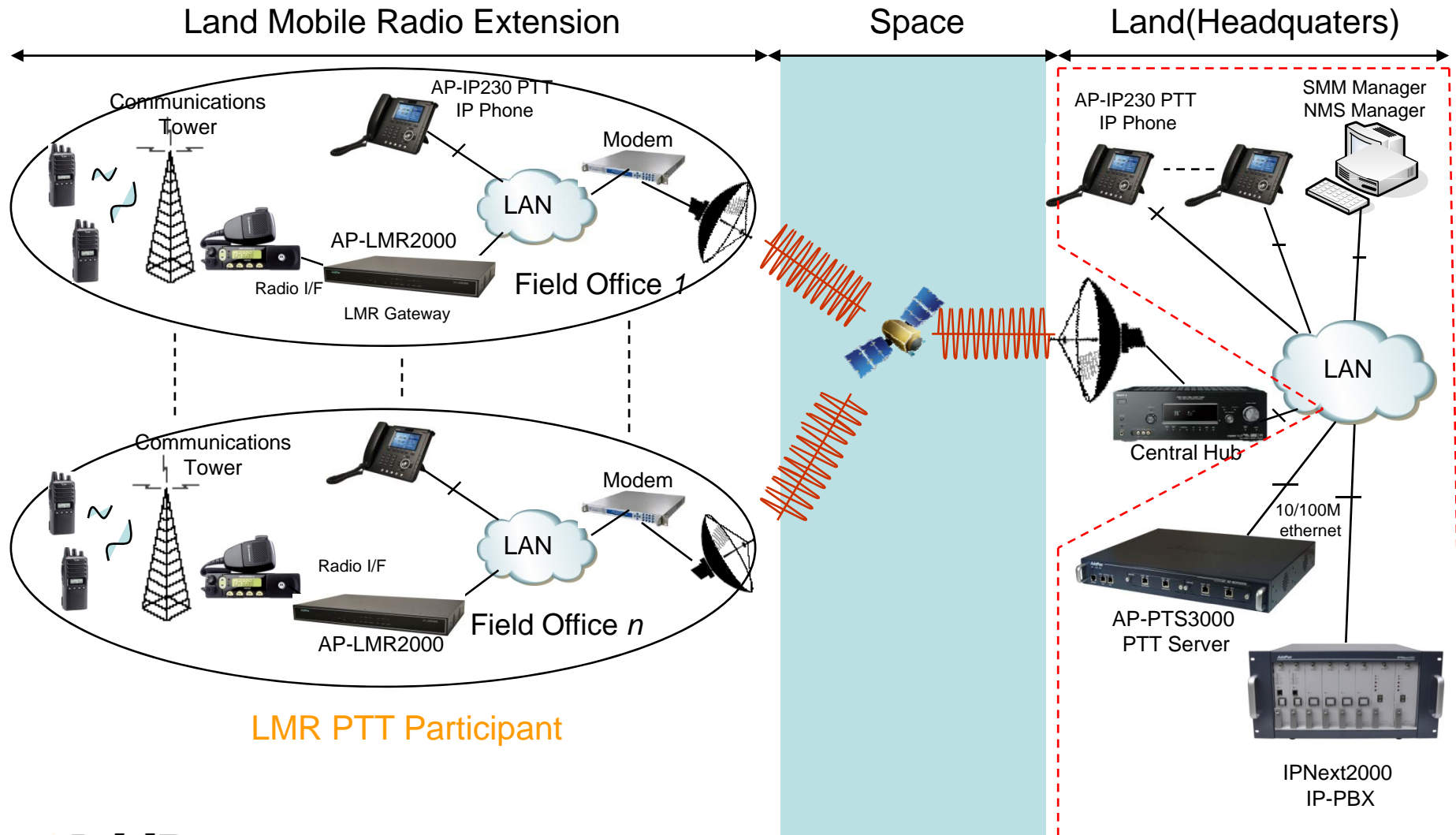

LMR PTT Participant

# RoIP Call Service Examples

## Interconnection LMR systems through PTT Server

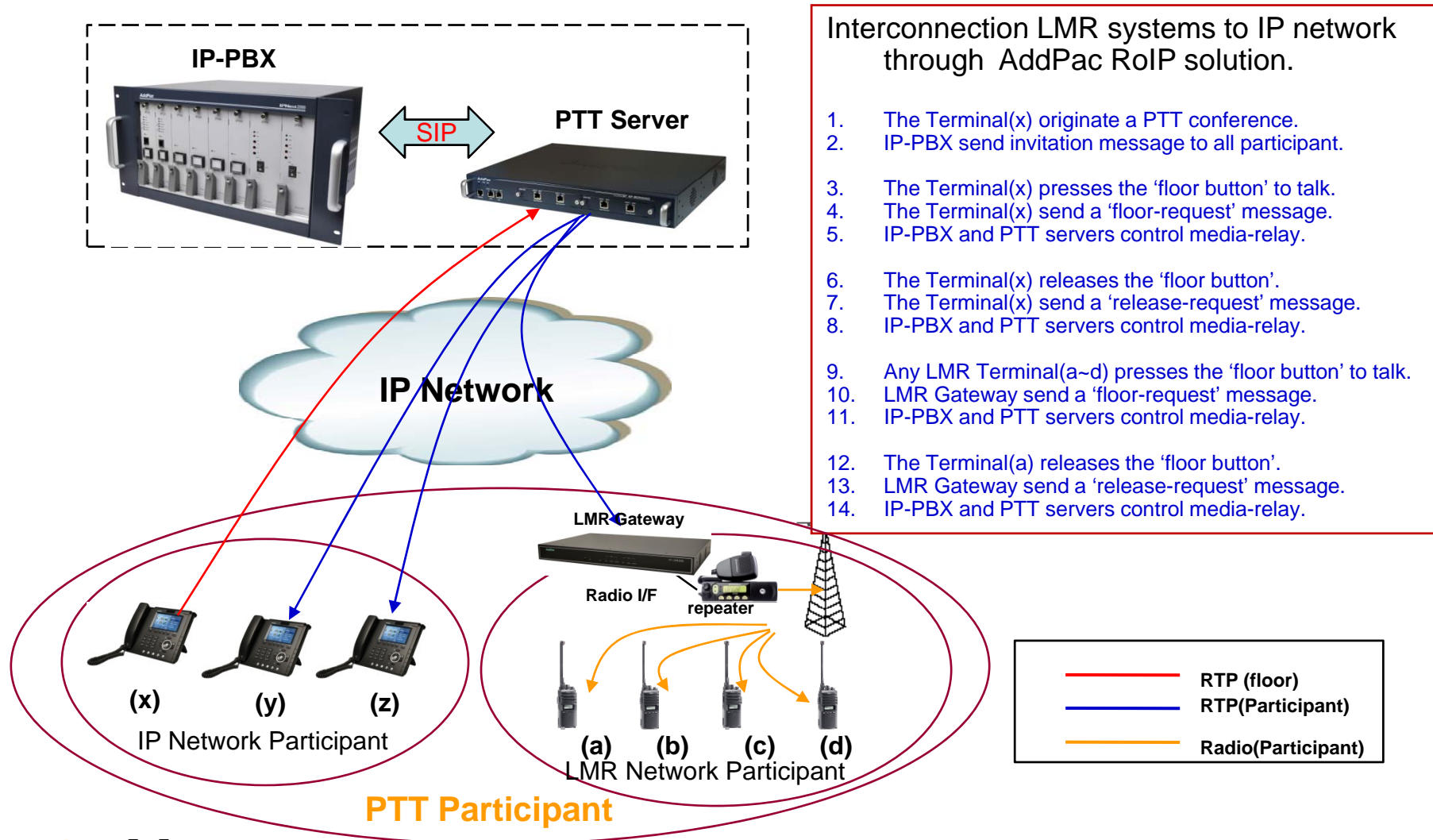

- Interconnection LMR systems to IP network through AddPac RoIP solution.
1. The Terminal(x) originate a PTT conference.
  2. IP-PBX send invitation message to all participant.
  3. The Terminal(x) presses the 'floor button' to talk.
  4. The Terminal(x) send a 'floor-request' message.
  5. IP-PBX and PTT servers control media-relay.
  6. The Terminal(x) releases the 'floor button'.
  7. The Terminal(x) send a 'release-request' message.
  8. IP-PBX and PTT servers control media-relay.
  9. Any LMR Terminal(a~d) presses the 'floor button' to talk.
  10. LMR Gateway send a 'floor-request' message.
  11. IP-PBX and PTT servers control media-relay.
  12. The Terminal(a) releases the 'floor button'.
  13. LMR Gateway send a 'release-request' message.
  14. IP-PBX and PTT servers control media-relay.

# RoIP System Message Flow

## SIP Message Flow (Register)

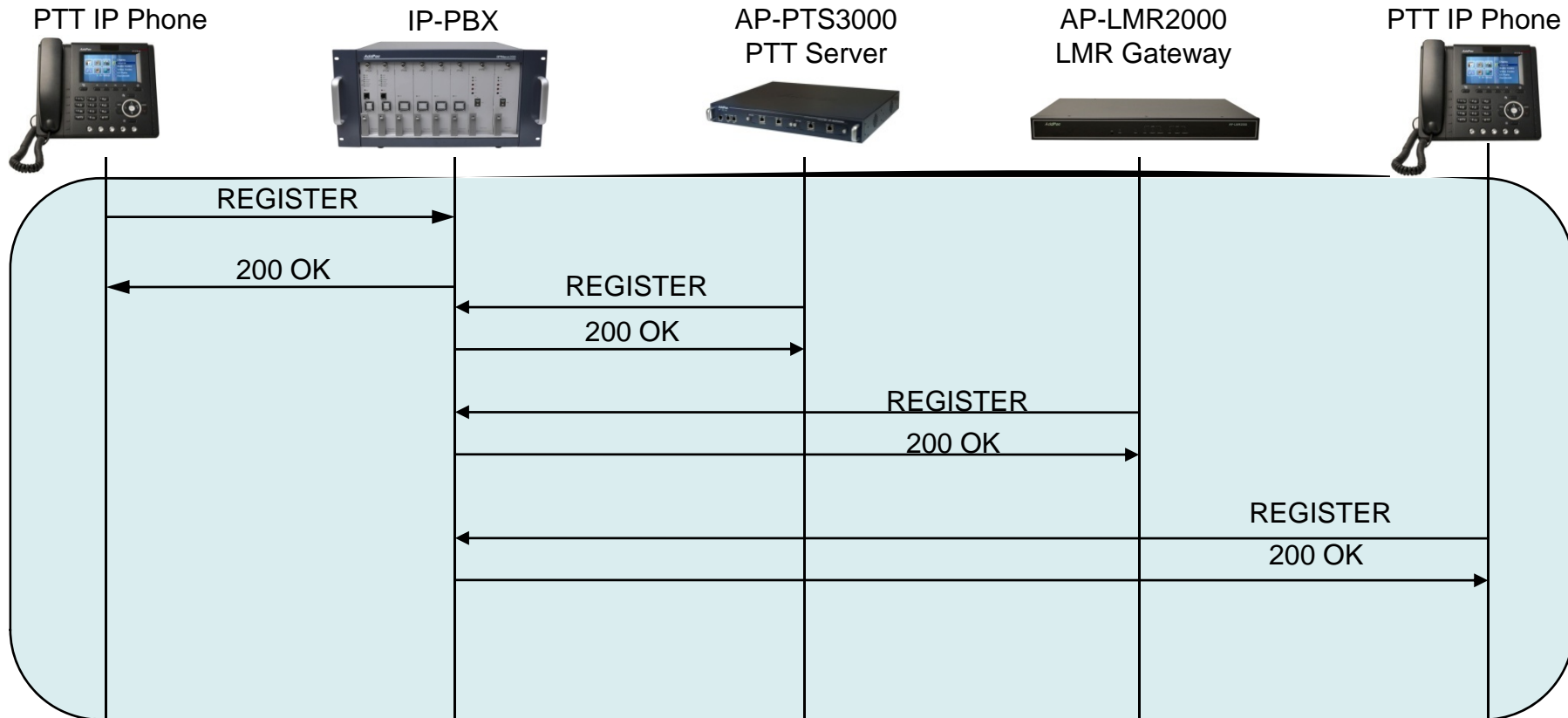

All Participants register to IP-PBX for PTT service.



# RoIP System Message Flow

## SIP Message Flow (Floor Control : Push To Talk)

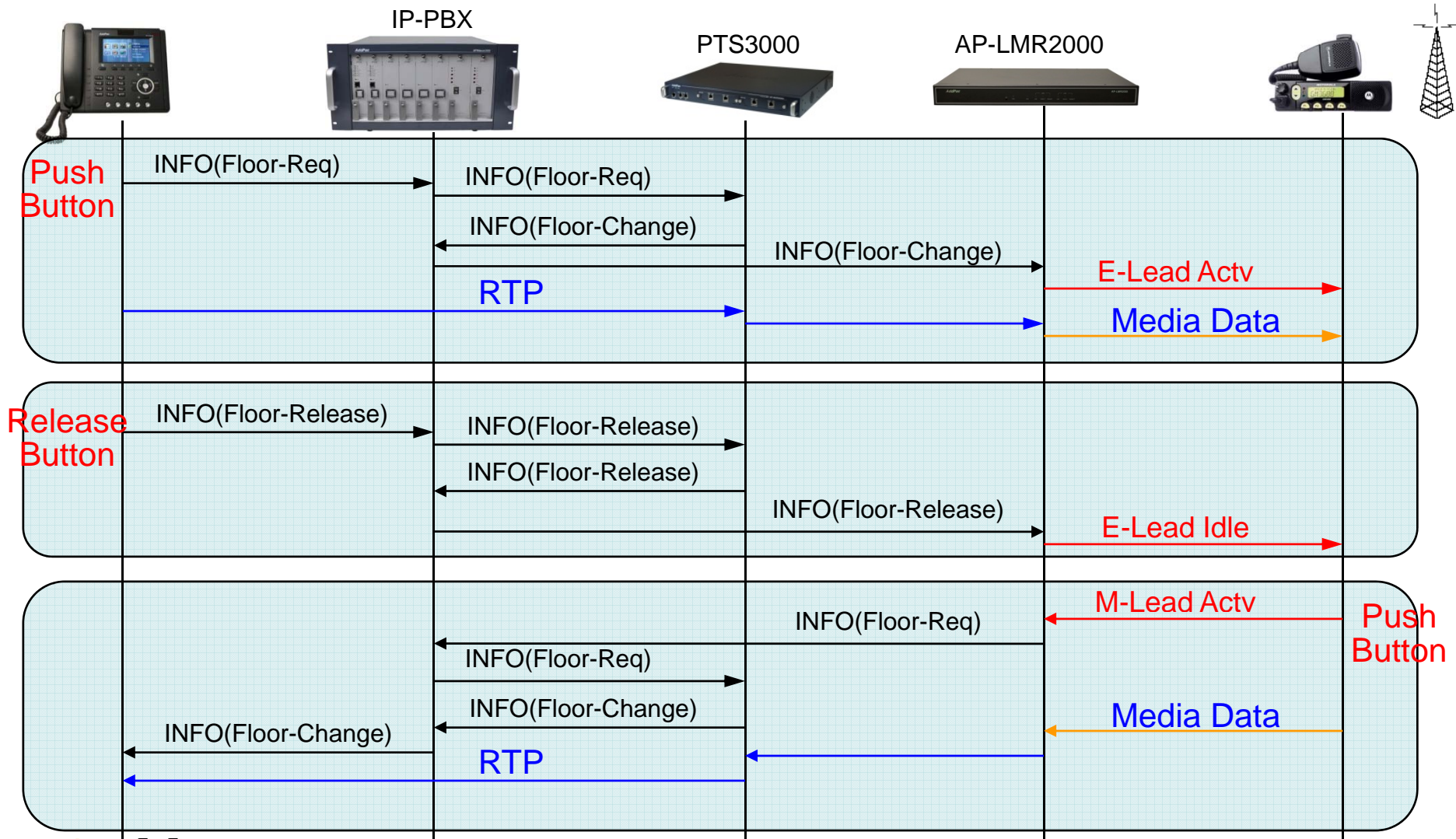

# IP based PTT Call Scenario (1/3)

- **Hot key usage**

- Move to push to talk List menu

1. **Press PTT key** < figure – 1 >

- Join

1. Move to PTT list menu
2. Select a PTT group.
3. Press Menu key and select 'Default' and ok key

< figure – 2 >

1. So, If **press and hold PTT key**,  
Join to your 'Default' PTT group  
In Idle state

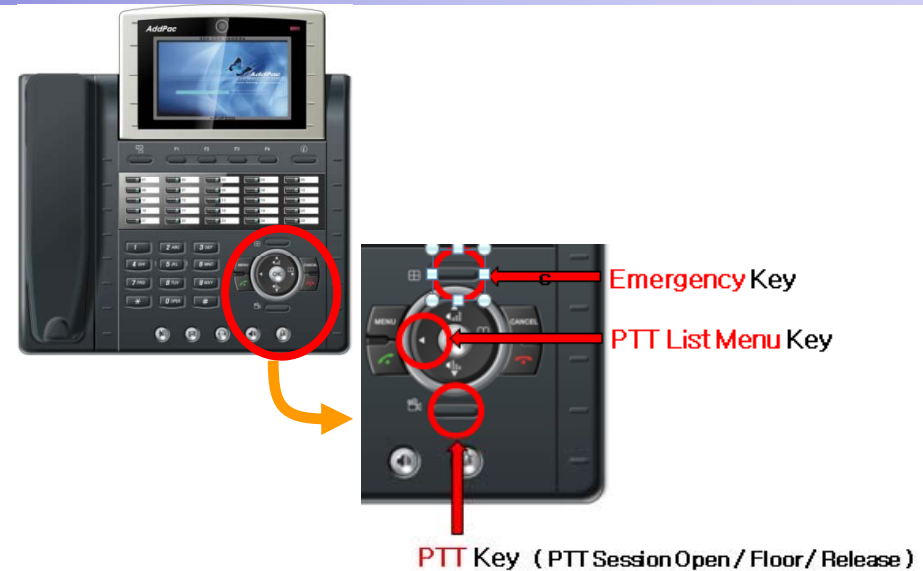

< figure – 1 >

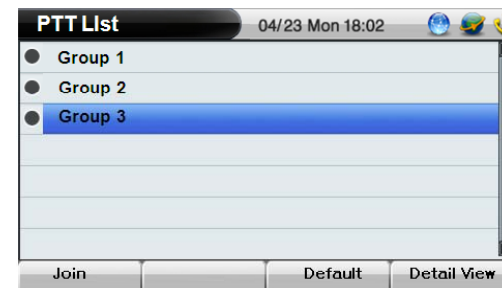

< figure – 2 >

# IP based PTT Call Scenario (2/3)

## Common Usage

Phase	Originator	Participant
Join	1. Press PTT key  2. Input Phone Number or Group Number	3. Notify Join w/ effect sound
Communication	Press and hold 'PTT key' and then speak to MIC	
Exit	Explicit exit : 'End key' Implicit exit : Automatic exit by server	

# IP based PTT Call Scenario(3/3)

## Emergency PTT with Alarm Notification

Phase	Originator	Participant
Join	1. Press right function key <i>&lt; page9 figure – 1 &gt;</i> 2. Input Phone Number or Group Number  4. Request emergency PTT service to server	3. Notify Alarm w/ siren sound <i>&lt; figure – 1 &gt;</i>  5. Notify Join w/ effect sound
Communication	Press and hold 'PTT key' and then speak to MIC <i>&lt; figure – 2 &gt;</i> <i>( Ignore any other PTT and call events )</i>	
Exit	Explicit exit : 'End key' Implicit exit : Automatic exit by server	

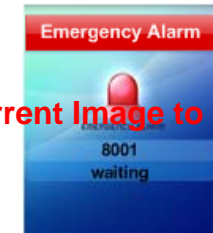

Replace current Image to New On

**< figure – 1 >**



Replace current Image to New On

**< figure – 2 >**



# RoIP Solution Components

# RoIP Solution Component List

IP-PBX	IPNext2000	
PTT Server	AP-PTS3000	
LMR Gateway	AP-LMR2000	
PTT IP Phone	AP-IP300, AP-IP230	

# IPNext2000 Next Generation IP-PBX



# Main Features

## IPNext2000 Next Generation IP-PBX

- SIP Application Server, Proxy, Registrar and Location Server
- Multiple ITSP Trunk with SIP & H.323 Accounts Support
- Dual System Redundancy Architecture
  - Two(2) Gigabit Ethernet Interface / System
- High Performance RISC Architecture
- Powerful Network Protocols (PPPoE, DHCP, Static Routing, etc)
- IPv4/IPv6 Dual Stack
- RTP Proxy Function Embedded for Private IP and IPv6 Address Interworking
- User Presence Service Features for Smart Multimedia Messenger and Smart IP Phone
- IVR Scenario Editor, Voice Mail, Media Service (Coloring), Conference
- Firmware Upgradeable Architecture
- Smart Multimedia Manager for IP-PBX Management
- Smart Messenger Service (click to dial) for Unified Communication
- Smart NMS for Large Scale Deployment
- Advanced Voice QoS Mechanism
- Dual Redundancy Power Module



# Hardware Specification

IPNext2000 Next Generation IP-PBX

RISC  
CPU

- 64bit High-End Microprocessor Computing Power
- Main Chassis
  - Dual Redundancy CPU Boards for System Fault Tolerant
    - Two(2) 10/100/1000Mbps Gigabit Ethernet
    - One(1) RS-232C Console (RJ45)
    - Two(2) 3.5 Inch Hard Disk Interface Slot (RAID 1)
  - Dual Redundancy Power Supply Module
  - Hot-Swap Features

# Hardware Specification

IPNext2000 Next Generation IP-PBX



## IPNext2000 Front Side

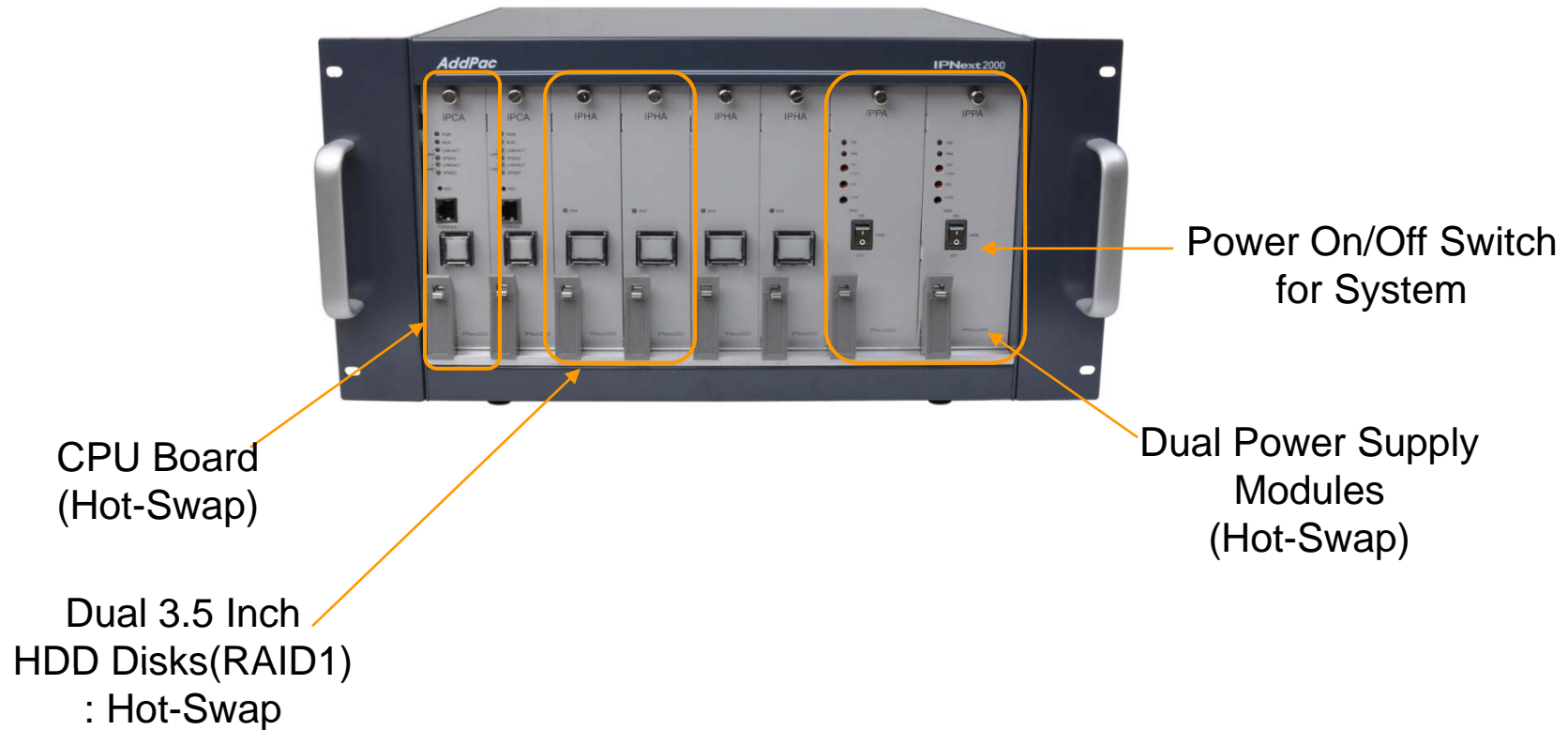

# Hardware Specification

IPNext2000 Next Generation IP-PBX System



## IPNext2000 Back Side

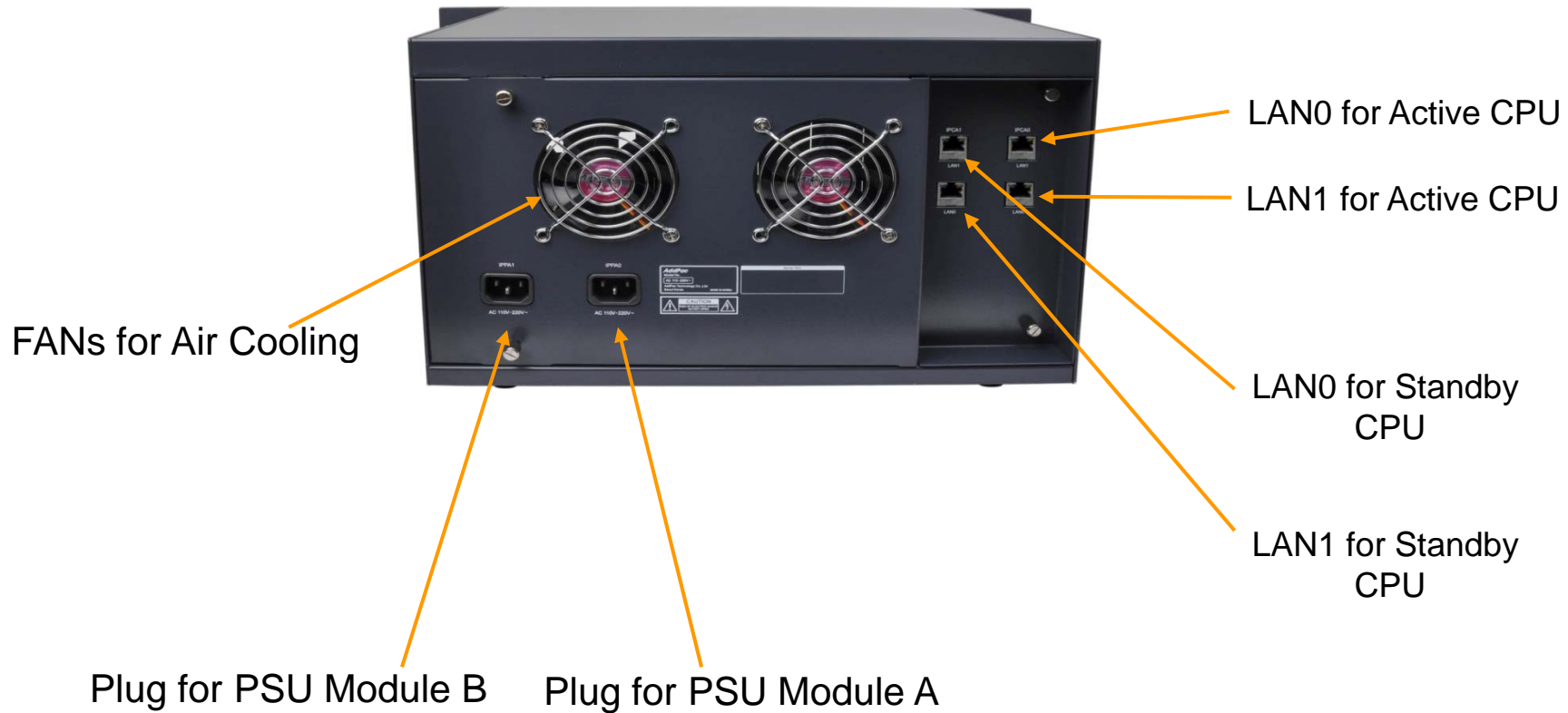

# AP-PTS3000 PTT Server



# Main Features

## AP-PTS3000 PTT Server

- Two(2) Module Slots for PTT Broadcasting Service
- Two(2) Gigabit Ethernet Interface Module
- IP based PTT Service Support
- Dial-Out based PTT Service Support
  - Multi-Session , Multi-Group
  - PtMP(Point-to-Multipoint) Service
  - PtP (Point-to-Point) Service
- Meet-me based PTT Service Support(Optional)
- IP-PBX Interworking Service
- IP Terminal Interworking Service (Wi-Fi Phone, IP Phones)
- Advanced Networking Protocols
- Firmware Upgradeable Architecture
- PTT Solution with Outstanding Network Service Capability

# Network Service and Features

AP-PTS3000 PTT Server

## Basic Network Protocols

- ARP, IP, IPv6, TCP, UDP, ICMP, ICMPv6, SCTP, IGMP, MLD

## Routing Protocol

- IPv4 : Static
- IPv6 : Static

## Service Protocol

- FTP, Telnet, TFTP, DHCP Server/Relay, SNMP Server
- CDP (Cisco Discovery Protocol)
- DNS Resolver , DDNS(nsupdate)
- Bridge
- Syslog
- IP/IPv6 policy control (QoS)
- VPDN (Virtual Private Dial-up Network : L2TP Server)

# Network Service and Features

AP-PTS3000 PTT Server

## IPv4/IPv6 Interworking

- NAT/PAT for IPv4
- IP connect (formerly ip-share) and device cascade for IPv4
- IP/IP, IP/GRE tunneling
- NAT-PT
- 6to4, Autoconfig tunneling

## IPv4 Address Configuration

- Fixed (Static)
- DHCP
- PPPoE

## IPv6 Address Configuration

- Fixed (Static)
- EUI-64
- Autoconfig (Neighbor Advertisement and Solicitation)

# Network Service and Features

AP-PTS3000 PTT Server

## Miscellaneous

- Cisco Style CLI
- Standard & Extended IPv4/IPv6 Access List
- Multi-level User Account Management
- IP accounting
- fsh (Embedded file system shell)
- STUN Client
- etc



# Network Service and Features

AP-PTS3000 PTT Server

## **SNMP MIBs**

- MIB-II
- RMON MIBs (Statistics, History, Alarm, Hosts Group)
- RFC2465 Management Information Base for IP Version 6: Textual Conventions and General Group
- RFC2466 Management Information Base for IP Version 6: ICMPv6 Group
- RFC2452 IP Version 6 Management Information Base for the Transmission Control Protocol
- RFC2454 IP Version 6 Management Information Base for the User Datagram Protocol
- AddPac Enterprise MIBs
- etc

# Hardware Specification

AP-PTS3000 PTT Server

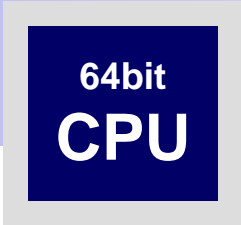

- Network Module (AP-AIM2-GE2)
  - Two(2) Port Gigabit Ethernet Module



One(1) RS232C Port for CLI





Two(2) Fast Ethernet for management

Two(2) Gigabit Ethernet for PTT Service



# LMR Gateways for PTT Service

# LMR Gateway Comparison Table

	AP-LMR1000 	AP-LMR2000 
Radio Interface Type	E&M, etc	E&M, etc
Module Slots for Radio Interface	1	2
Port Number /Module	2	2
Radio Interface Ports	2	4
IPv4/IPv6 Dual Stack Support	Support	Support
VoIP Signaling	H.323/SIP	H.323/SIP
TLS/SRTP Secure Protocol	Support	Support
Management	CLI/Web	CLI/Web
LAN Port	2	2
Console Port for CLI	1	1



# AP-LMR2000 LMR Gateway

# Main Features

## AP-LMR2000 LMR Gateway

- LMR over IP Service Support
- Radio Systems(Motorola, etc) are Extended to IP Network
- High Performance RISC & Programmable DSP Architecture
- Two(2) 10/100Mbps Fast Ethernet (IP Share ,etc)
- High Performance LAN-to-LAN Routing Capability
- Two(2) Module Slots for Radio Interface (E&M, etc)
- VoIP Codec : G.711/G.726/G.723/G.729, VAD, etc
- Powerful Network Protocols (PPPoE, DHCP, Static Routing, etc)
- IPv4/IPv6 Dual Stack Support
- SIP/H.323 Dual Concurrent Signaling Protocols
- TLS/SRTP VoIP Secure Protocol Support (AES, 3DES, etc)
- Firmware Upgradeable Architecture
- Advanced Voice QoS Mechanism
- Powerful Web based Management
- RS232C Port Support for Command Line Interface
- AddPac Total Solution Component for Radio over IP

# Hardware Specification

AP-LMR2000 LMR Gateway

RISC  
CPU

High-end  
DSP

- RISC Microprocessor Computing Power
- Main Chassis
  - Network Interface
    - Two(2) 10/100Mbps Fast Ethernet
    - One(1) RS-232C Console (RJ45)
  - Two(2) Radio Module Slots for E&M, etc



# Hardware Specification

AP-LMR2000 LMR Gateway

RISC  
CPU

High-end  
DSP

## AP-LMR2000 Back Side

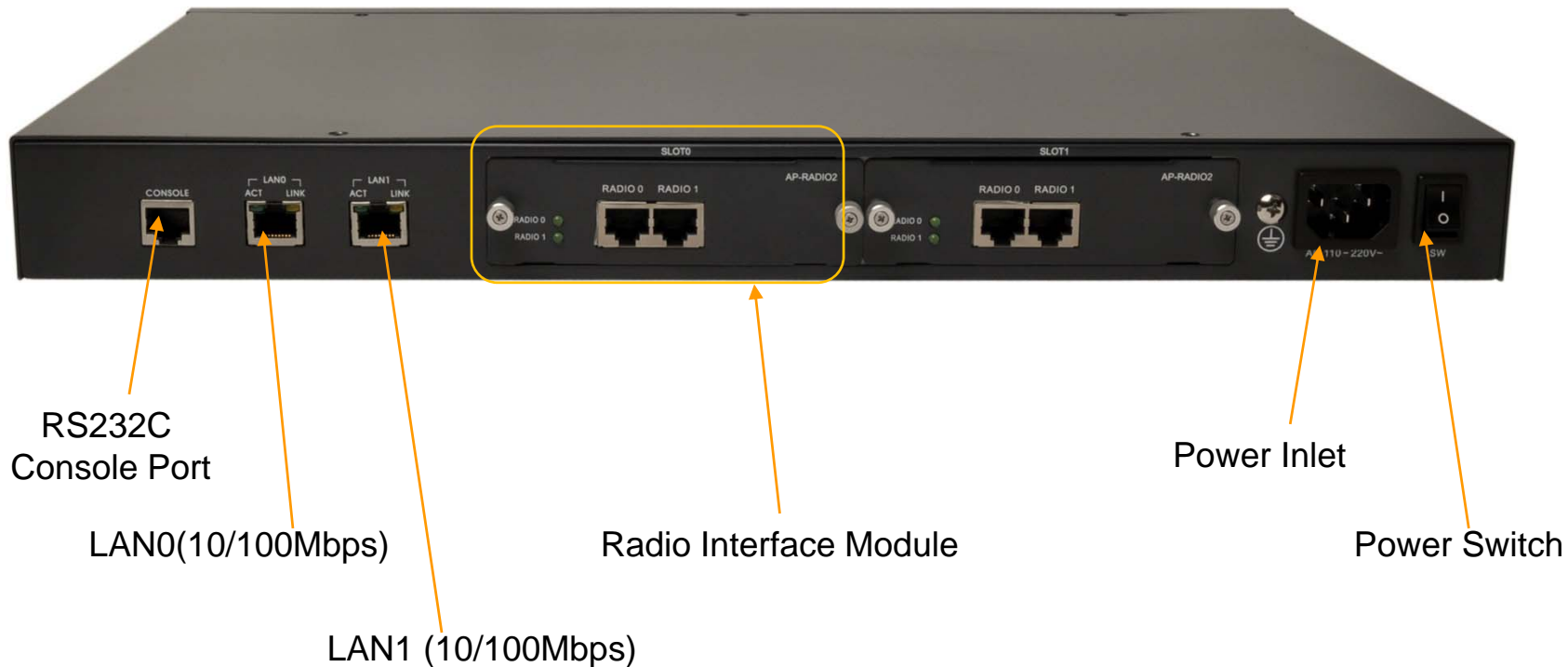



# Hardware Specification

AP-LMR2000 LMR Gateway

RISC  
CPU

High-end  
DSP

## Example : E&M Interface for Radio Interworking

Lead Name	Pin	Description
E (Ear or Earth)	Pin 7	Signal wire asserted by the router toward the connected device. Typically mapped to the push-to-talk (PTT) lead on the radio.
M (Mouth or Magnet)	Pin 2	Signal wire asserted by the router toward the connected device. Typically mapped to the push-to-talk (PTT) lead on the radio.
SG (Signal Ground)	Pin 8	Used on E&M signaling Types II, III, and IV.
SB (Signal Battery)	Pin 1	Used on E&M signaling Types II, III, and IV.
<b>Two-Wire Mode</b>		
T1/R1 (Tip-1/Ring-1)	Pin 4,5	In two-wire operation, the T1/R1 leads carry the full-duplex audio path.
<b>Four-Wire Mode</b>		
T/R (Tip/Ring)	Pin6,3	In a four-wire operation configuration, this pair of leads carries the audio in from the radio to the router and would typically be connected to the line out or speaker of the radio.
T1/R1 (Tip-1/Ring-1)	Pin5,4	In a four-wire operation configuration, this pair of leads carries the audio out from the router to the radio and would normally be connected to the line in or microphone on the radio

# Hardware Specification

AP-LMR2000 LMR Gateway

RISC  
CPU

High-end  
DSP

Example : E&M Interface for Radio Interworking





# AP-LMR1000 LMR Gateway

# Main Features

## AP-LMR1000 LMR Gateway

- LMR over IP Service Support
- Radio Systems(Motorola,etc) are Extended to IP Network
- High Performance RISC & Programmable DSP Architecture
- Two(2) 10/100Mbps Fast Ethernet (IP Share ,etc)
- High Performance LAN-to-LAN Routing Capability
- One(1) Module Slots for Radio Interface (E&M, etc)
- VoIP Codec : G.711/G.726/G.723/G.729, VAD, etc
- Powerful Network Protocols (PPPoE, DHCP, Static Routing, etc)
- IPv4/IPv6 Dual Stack Support
- SIP/H.323 Dual Concurrent Signaling Protocols
- TLS/SRTP VoIP Secure Protocol Support (AES, 3DES, etc)
- Firmware Upgradeable Architecture
- Advanced Voice QoS Mechanism
- Powerful Web based Management
- RS232C Port Support for Command Line Interface
- AddPac Total Solution Component for Radio over IP

# Hardware Specification

## AP-LMR1000 LMR Gateway

RISC  
CPU

High-end  
DSP

- RISC Microprocessor Computing Power
- Main Chassis
  - Network Interface
    - Two(2) 10/100Mbps Fast Ethernet
    - One(1) RS-232C Console (RJ45)
  - One(1) Radio Module Slots for E&M, etc
  - Internal Power Supply



# Hardware Specification

AP-LMR1000 LMR Gateway

RISC  
CPU

High-end  
DSP

AP-LMR1000 Front Side

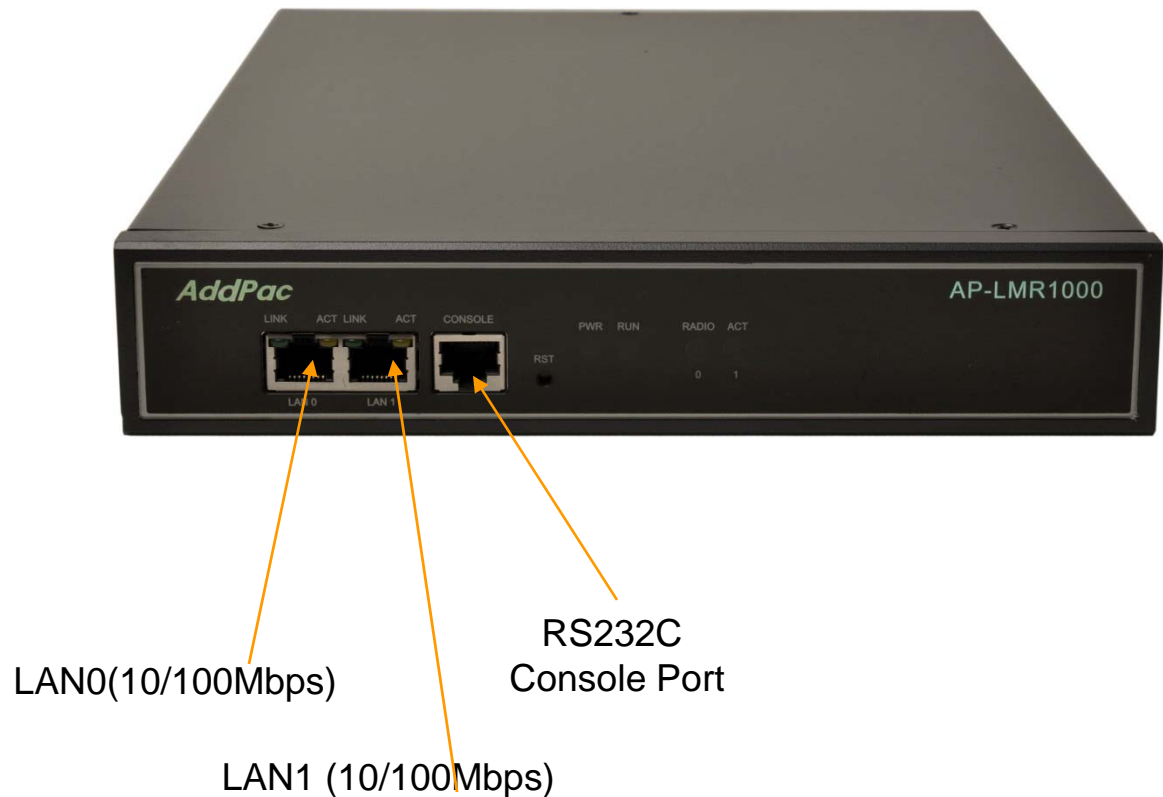

# Hardware Specification

AP-LMR1000 LMR Gateway

RISC  
CPU

High-end  
DSP

## AP-LMR1000 Back Side

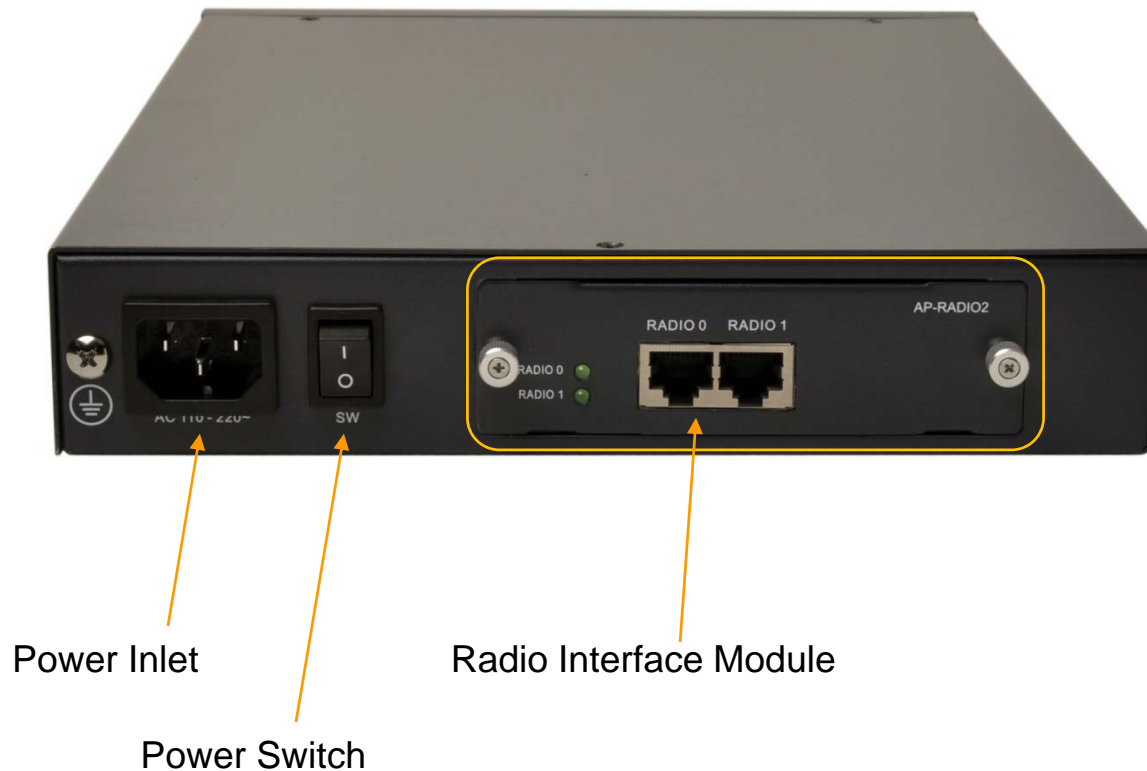

# Network Diagram

## AP-LMR1000 LMR Gateway

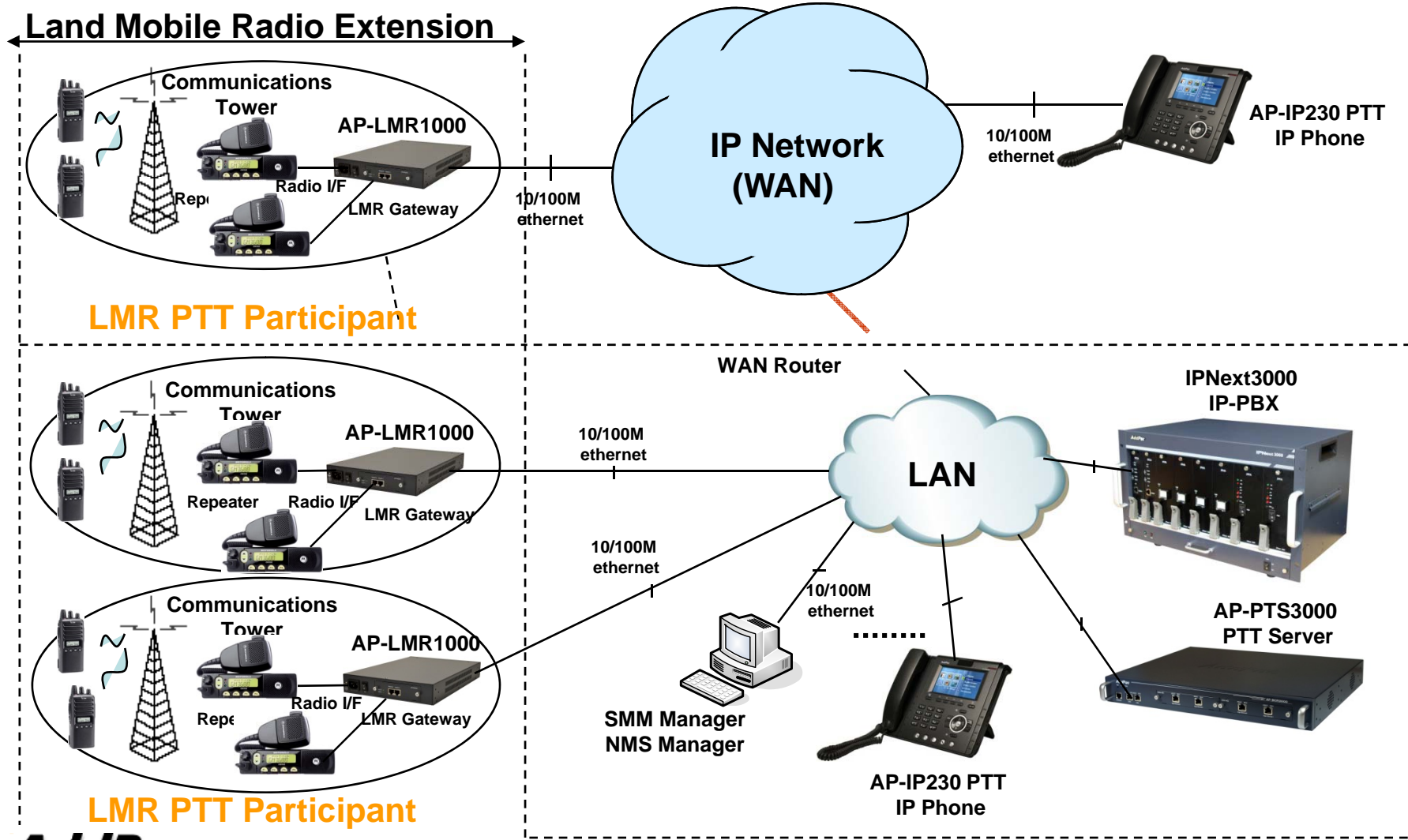





# IP Phones for PTT Service

# AP-IP230 IP Phone for PTT Service



# Main Features

## AP-IP230 IP Phone

- 5.0 Inch Color LCD Display
- External I/O Interface
  - Audio In/Out
  - Two(2) Fast Ethernet Interface
  - PSTN FXO Interface (optional)
- PoE (Power over Ethernet) Support
- Touch Screen based 25 Speed Dial button with Presence Indication
- Audio Broadcasting Controller & Terminal
- Providing Powerful Push-to-Talk Service
- Powerful Color GUI
- IPv4/IPv6 Address Support
- SIP, H.323 Signaling Support
- High-end Error Resilient Against Various Packet Error

# Hardware Specification

## AP-IP230 IP Phone

- RISC+DSP Microprocessor Computing Power (Dual Processor Architecture)
- High Quality 5.0 Inch Color LCD Panel
- Touch Screen based 25 Speed Dial button with Presence Indication
- Optional PSTN Backup Interface
  - FXO Interface
- High quality Audio and Voice Interface
  - Stereo Audio Input Connector
  - Stereo Audio Output Connector
- Network Interface
  - Two(2) 10/100Mbps Fast Ethernet
- USB Host Mode Interface
  - USB Memory(Flash, HDD), etc
- Power Supply
  - Power over Ethernet
  - External Power Adaptor (5V, 3A)

# Hardware Specification

AP-IP230 IP Phone



5 Inch Color LCD with touch screen

Soft Keys

Emergency Key

PTT List Menu Key

PTT key (PTT session Open/Floor/Release)

# AP-IP300 IP Phone for PTT Service



# Main Features

## AP-IP300 IP Phone

- 4.3 Inch Color LCD Display
- External I/O Interface
  - Audio In/Out
  - Two(2) Fast Ethernet Interface
  - PSTN FXO Interface (optional)
- PoE (Power over Ethernet) Support
- 25 Speed Dial button with Presence Indication Lamp
- Audio Broadcasting Controller & Terminal
- Providing Powerful Push-to-Talk Service
- Powerful Color GUI
- IPv4/IPv6 Address Support
- SIP, H.323 Signaling Support
- High-end Error Resilient Against Various Packet Error

# Hardware Specification

## AP-IP300 IP Phone

- RISC+DSP Microprocessor Computing Power (Dual Processor Architecture)
- High Quality 4.3 Inch Color LCD Panel
- 25 Speed Dial Key & User Presence Indication LED
- Optional PSTN Backup Interface
  - FXO Interface
- High quality Audio and Voice Interface
  - Stereo Audio Input Connector
  - Stereo Audio Output Connector
- Network Interface
  - Two(2) 10/100Mbps Fast Ethernet
- USB Host Mode Interface
  - USB Memory(Flash, HDD), etc
- Power Supply
  - Power over Ethernet
  - External Power Adaptor (5V, 3A)





# Hardware Specification

AP-IP300 IP Phone

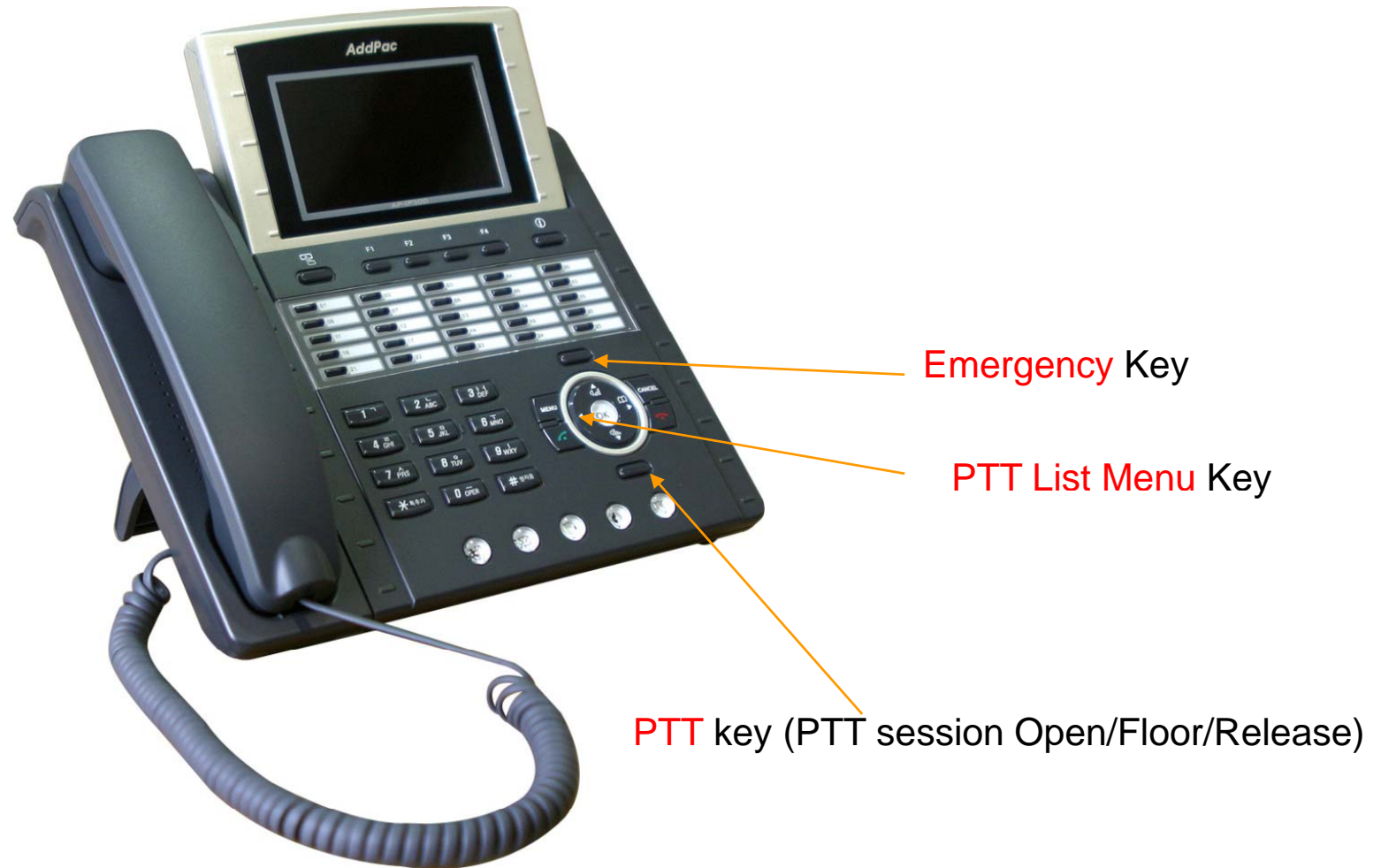

# SMM(Smart Multimedia Manager) for PTT Solution

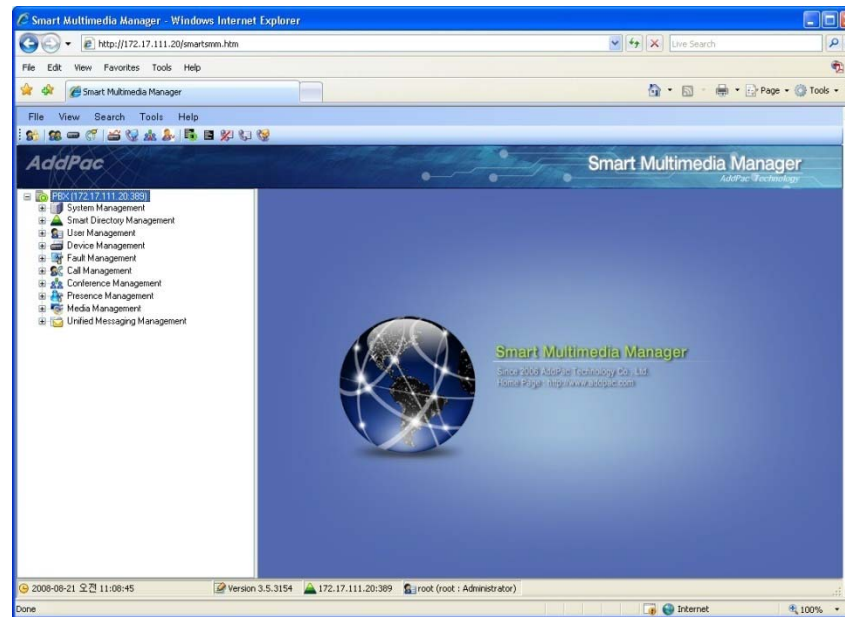

# System Requirement

SMM for PTT Service

## PC

- CPU : Intel Pentium 4 or Higher
- Physical Memory : 1 GB or Higher
- HDD : 100M or Higher

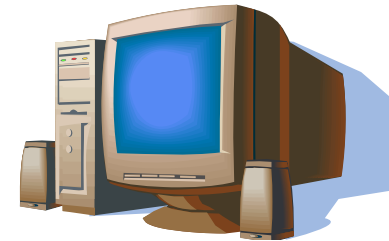

## OS

- Windows XP, Windows 2003 server, Windows Vista

## Web Browser

- Internet Explorer 5.0 or Higher

## .NET Framework

- Net Framework 2.0 or Higher

URL : <http://www.microsoft.com/downloads/details.aspx?FamilyID=0856eacb-4362-4b0d-8edd-aab15c5e04f5&DisplayLang=en>

# Main Features

SMM for PTT Service

- AddPac Telephony system management application ( IPNext IP-PBX, Smart Directory Server, MCU, PS, RBT, UMS, Phone, etc)
- System Configuration
- System Monitoring
- System Call Monitoring
- System Call History
- System Statistics and Report
- System Fault Management
- LDAP Data Management

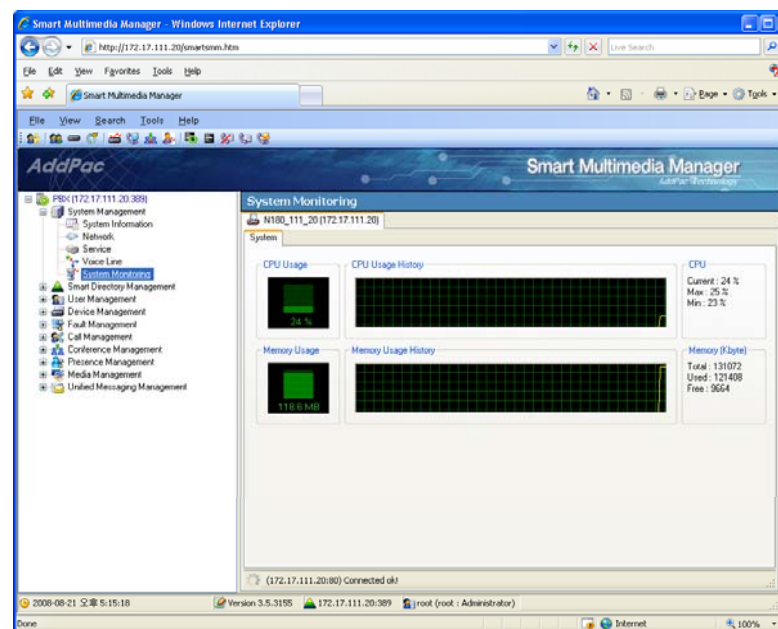

# NMS System for PTT Solution

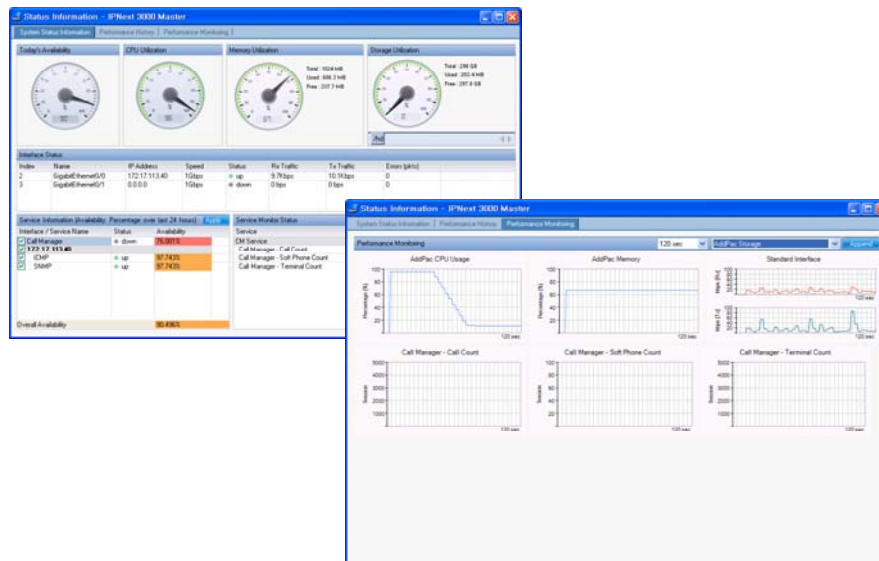

# System Requirement

## Network Management System for PTT Server

### **NMS Server**

- OS : RHEL (Redhat Enterprise Linux) 5.0 or higher
- CPU : Quad-Core 2.0 GHz / 1333MHz FSB 2x4 MB cache
- Physical Memory : 4 GB
- HDD : 300 G
- JRE (Java Runtime Environment) 1.5.1 or Higher
- Database : PostgreSQL 8.1.11

### **NMS Client**

- Windows XP, Vista, Windows Server 2000/2003
- Microsoft Internet Explorer 6.0 or higher

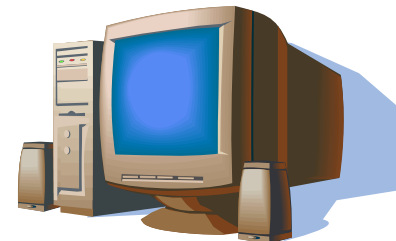

# Main Features

## Network Management System for PTT Server

- Server & Client Architecture
- Web-based Management
- Network Resource Management
- Device Fault Management
- Device Fault History Management
- Device Status Information
- Notification Management
- Fault Statistics
- Model & Service Management

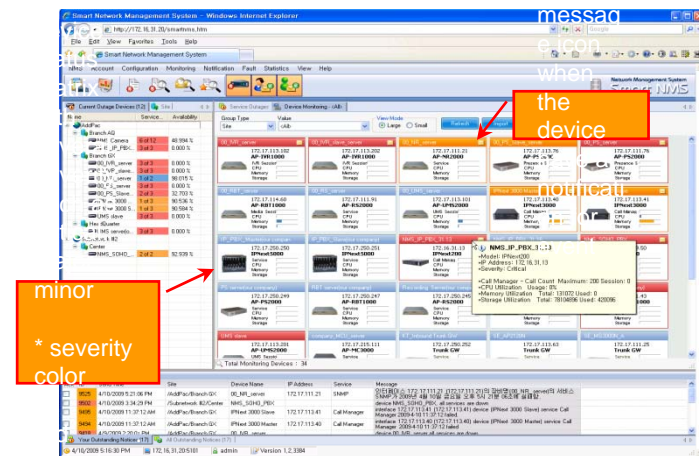



# Thank you!

AddPac Technology Co., Ltd.  
Sales and Marketing

Phone +82.2.568.3848 (KOREA)

FAX +82.2.568.3847 (KOREA)

E-mail [sales@addpac.com](mailto:sales@addpac.com)