



# IPNext210™

## Hybrid IP-PBX System

High Performance Hybrid IP-PBX Solution

### RTP Proxy Service for Private IP Problem Solving



# **AddPac**

**AddPac Technology**

2011, Sales and Marketing

[www.addpac.com](http://www.addpac.com)

# Contents

- Overview
- RTP Proxy Configuration
  - Public/Private RTP proxy
  - Asymmetric/Symmetric NAT
  - RTP Broadcast
  - RTP Conference
  - IPv4/IPv6 RTP Proxy
- Signal Flow Diagram

# Service Overview

- Protocol Independence (H.323, SIP, MGCP)
- Support RTP Proxy without NAT
- Support Symmetric / Asymmetric NAT
- Support IPv4/IPv6 RTP Proxy
- Support RTP Broadcast
- Support RTP Conference

# RTP Proxy Configuration



# Public/Private RTP Proxy without NAT Router

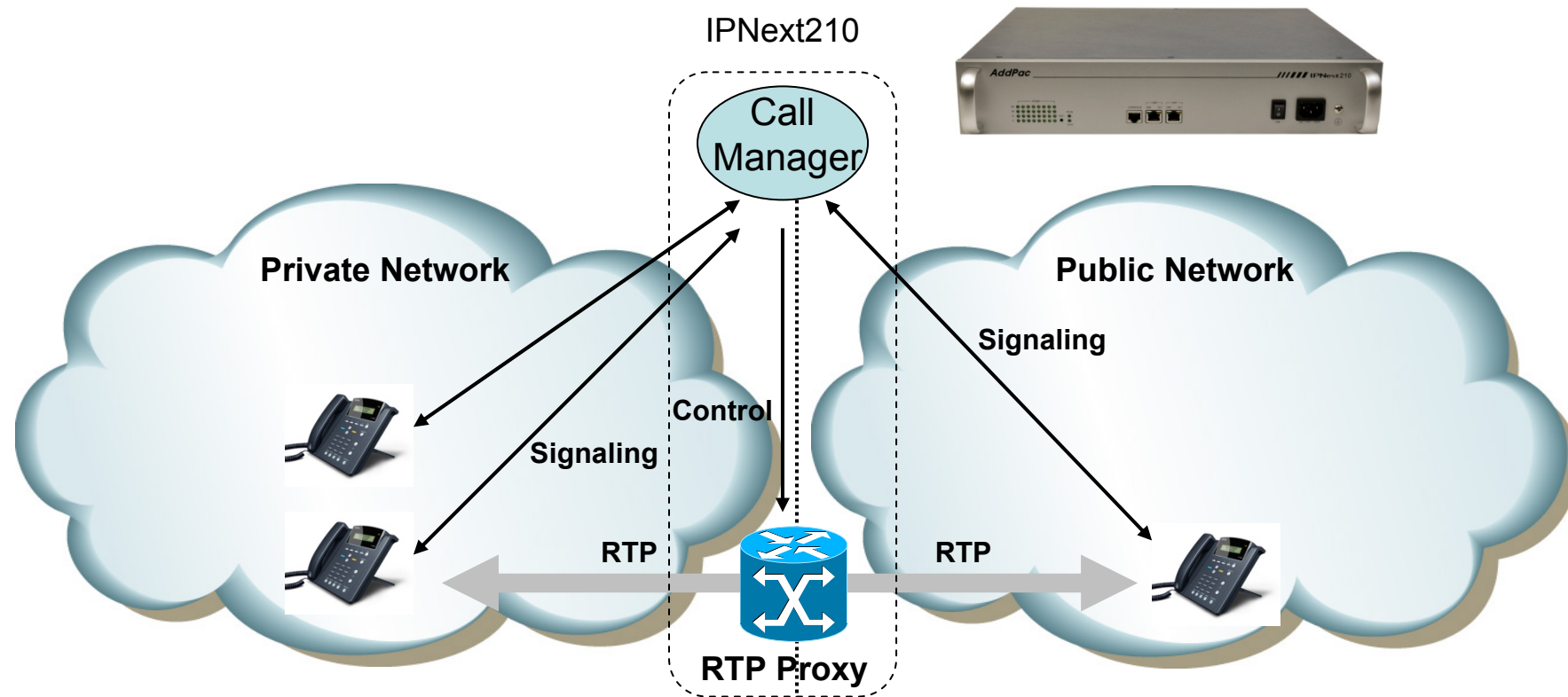

- Located between public and private network
- Call manager and RTP proxy has public and private address
- Call manager determine that the call is internal or external

# Asymmetric/Symmetric NAT

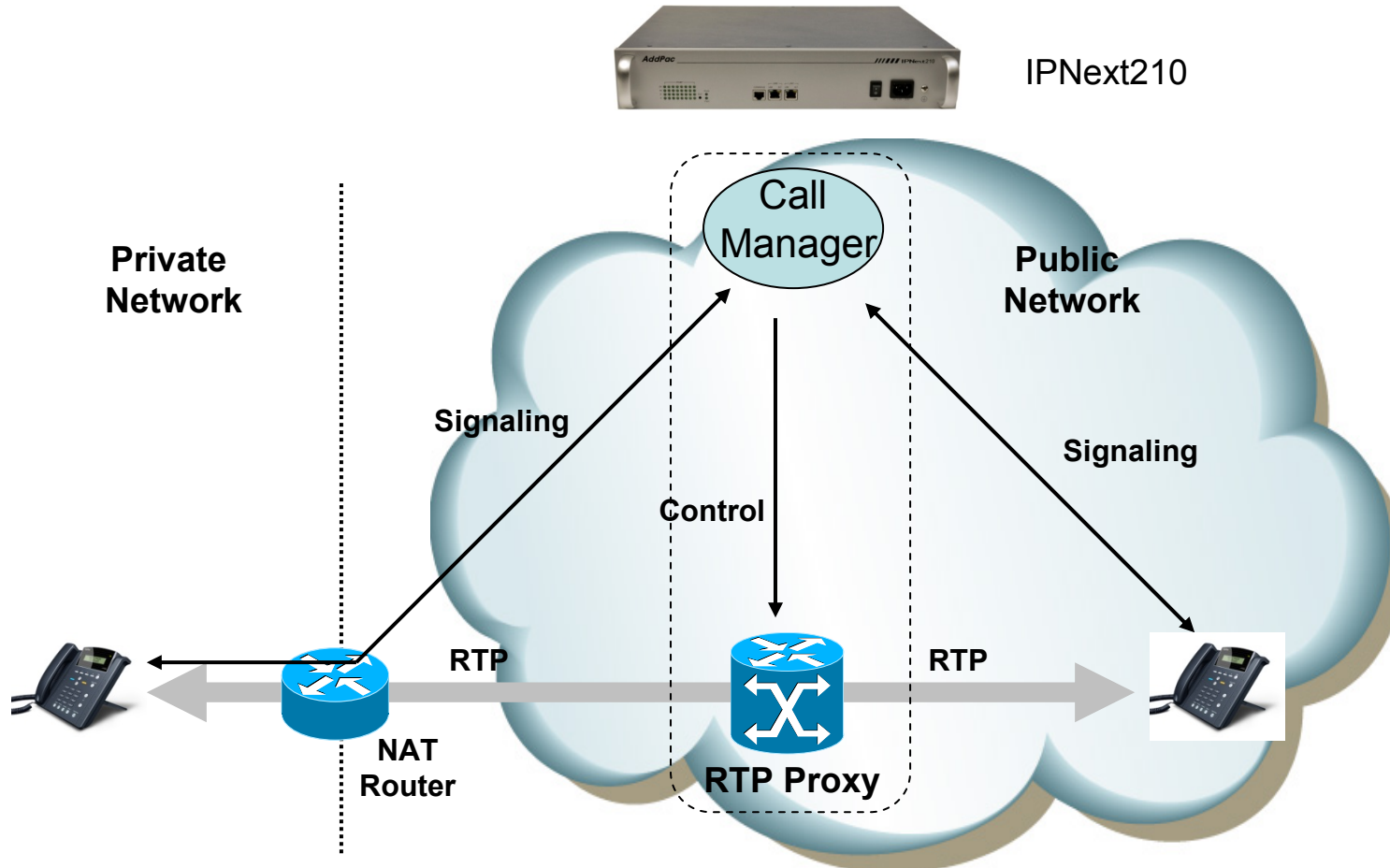

- Located in public network
- RTP Proxy has single public address
- Auto detect for asymmetric NAT via incoming RTP packet

# RTP Proxy Communication between Private IP

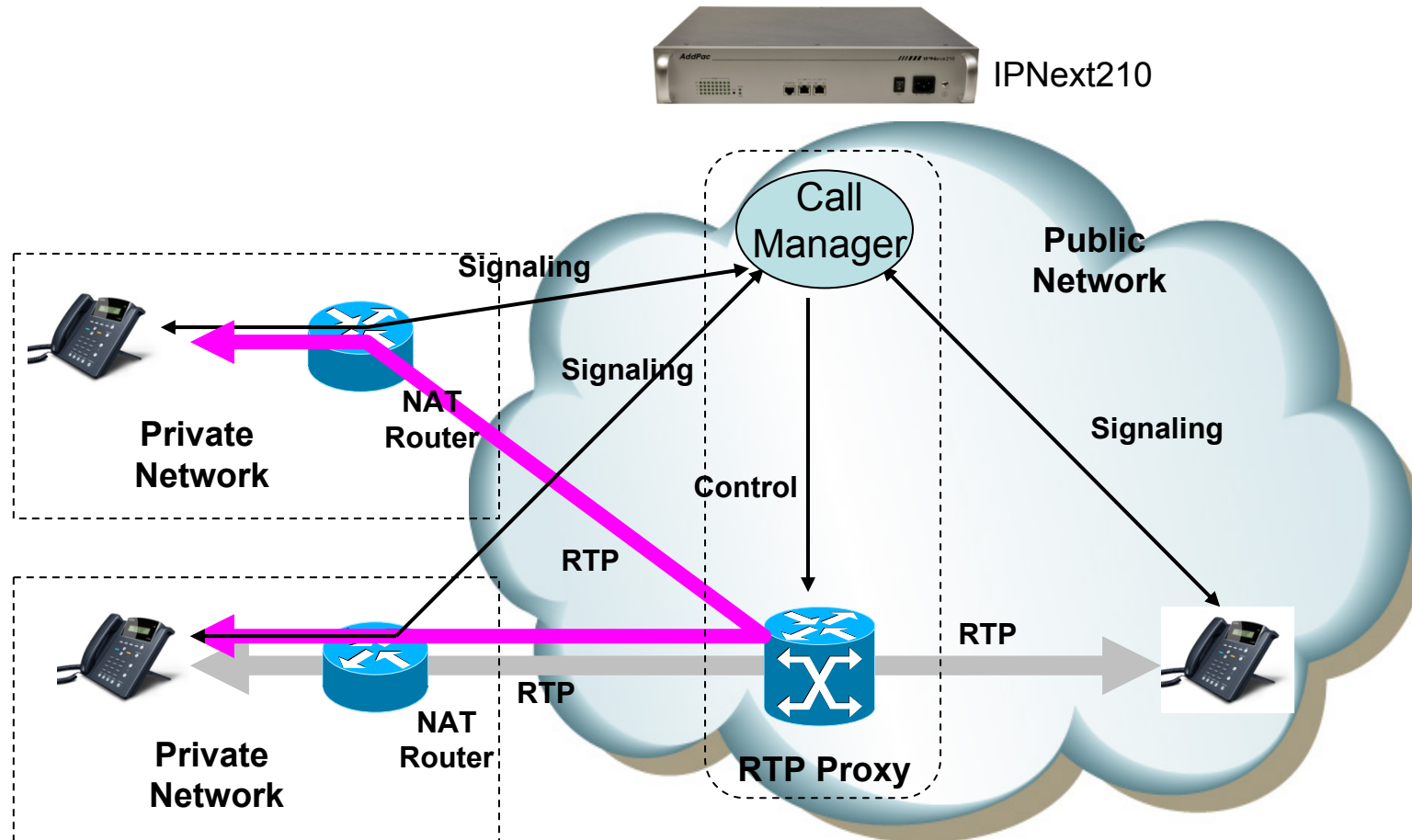

- Located in public network
- RTP Proxy has single public address
- Auto detect for asymmetric NAT via incoming RTP packet

# RTP Broadcast

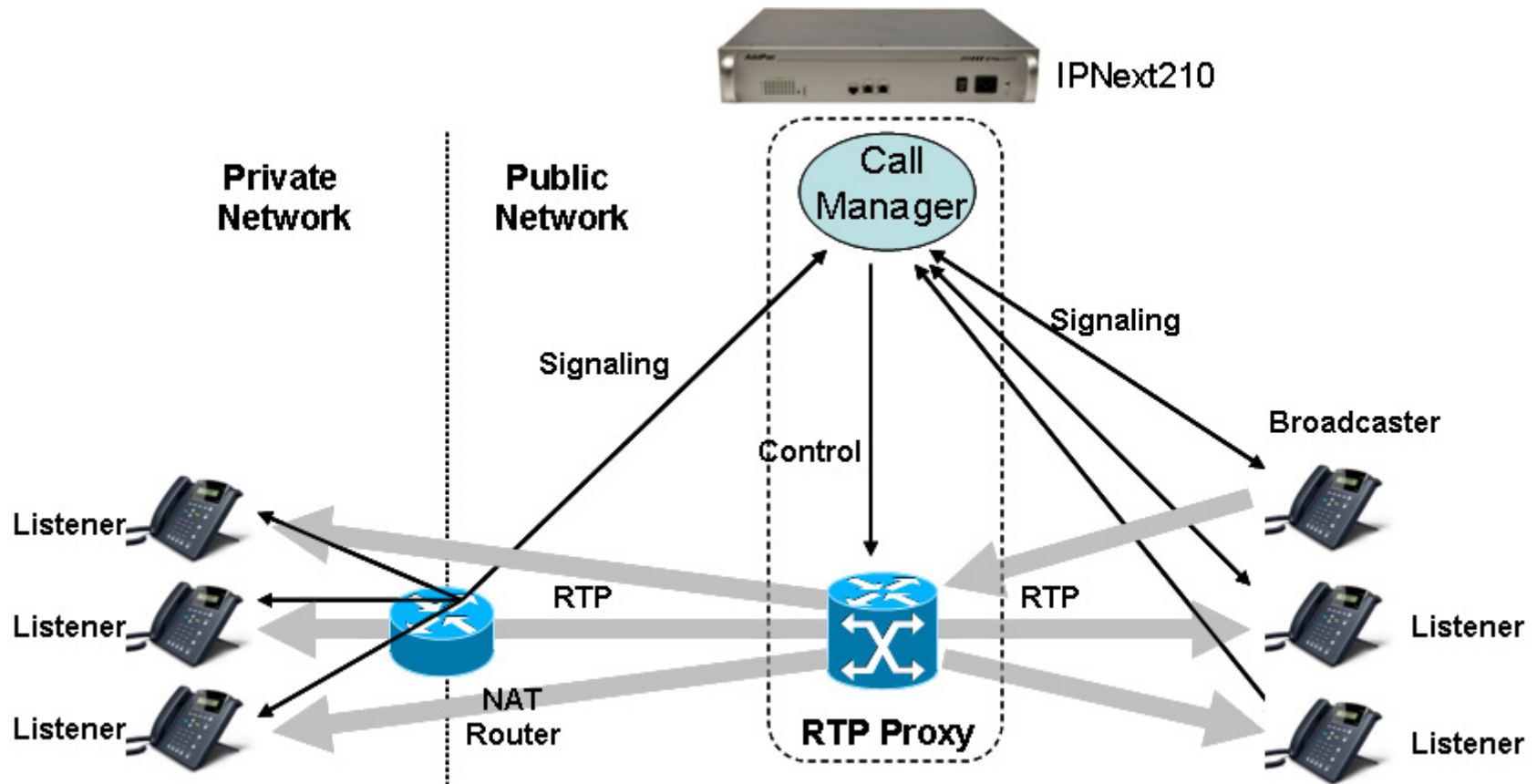

- Call Manager set the broadcaster and listener via control message
- One broadcaster and multiple listener
- RTP proxy relay for broadcaster RTP traffic
- RTP proxy never relay for listener traffic



# RTP Conference

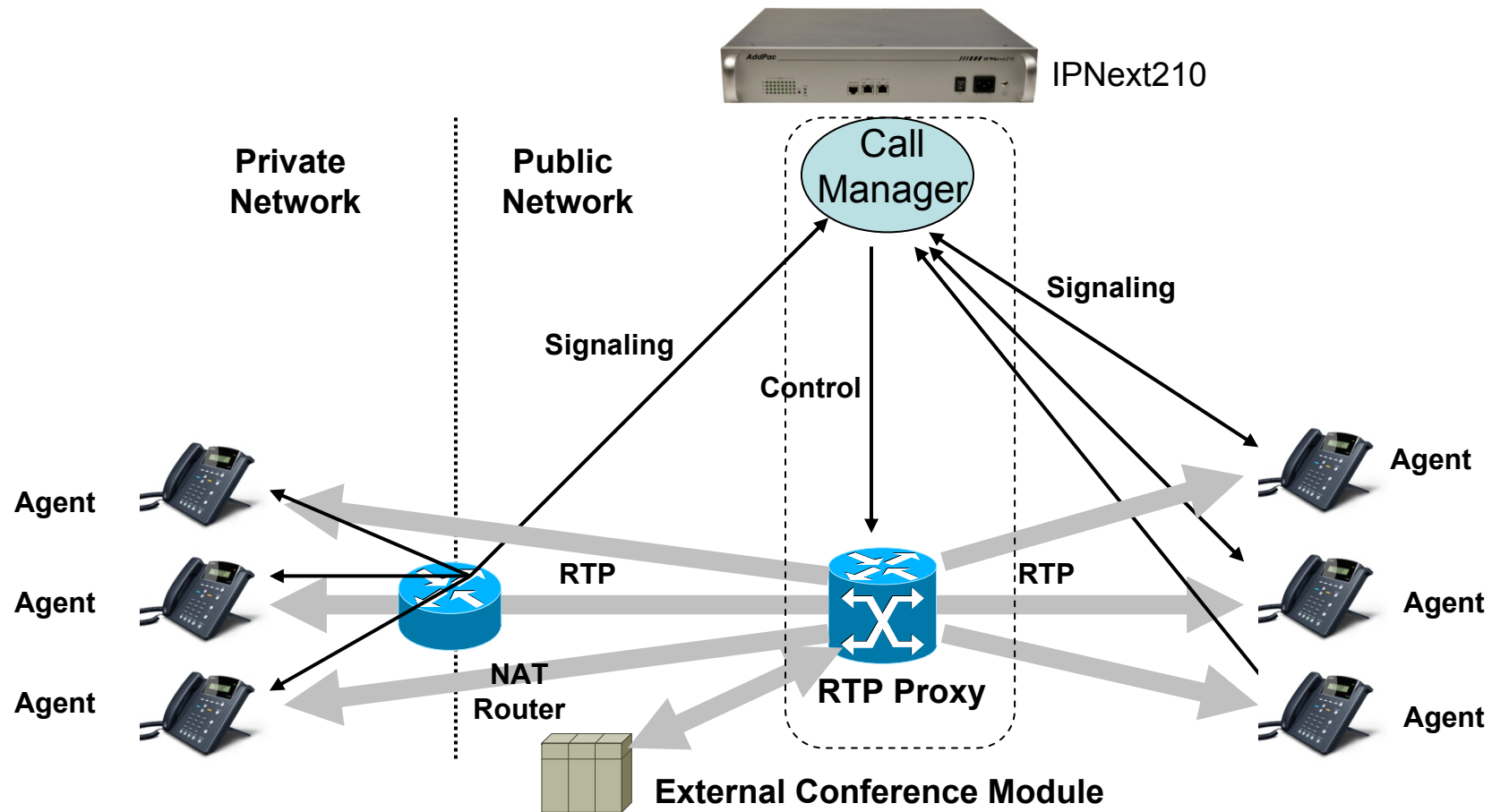

- RTP Proxy communicate with external/internal conference module (mixer)
- Conference support for private address, asymmetric NAT

# IPv4/IPv6 RTP Proxy

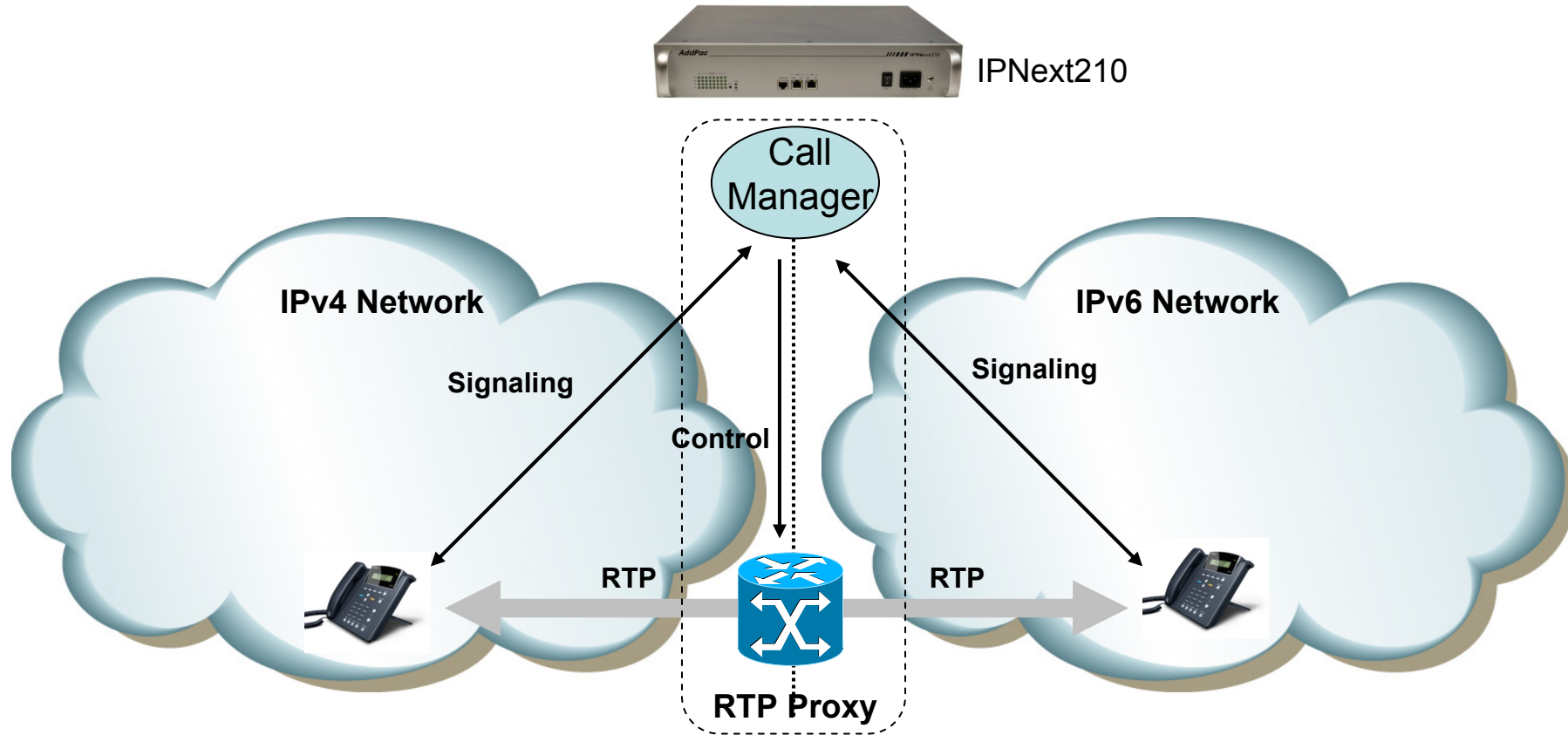

- Call manager and RTP proxy has IPv4 and IPv6 address
- Support RTP broadcasting



# Signal Flow Diagram

# Signal Flow Diagram (Ex: SIP)

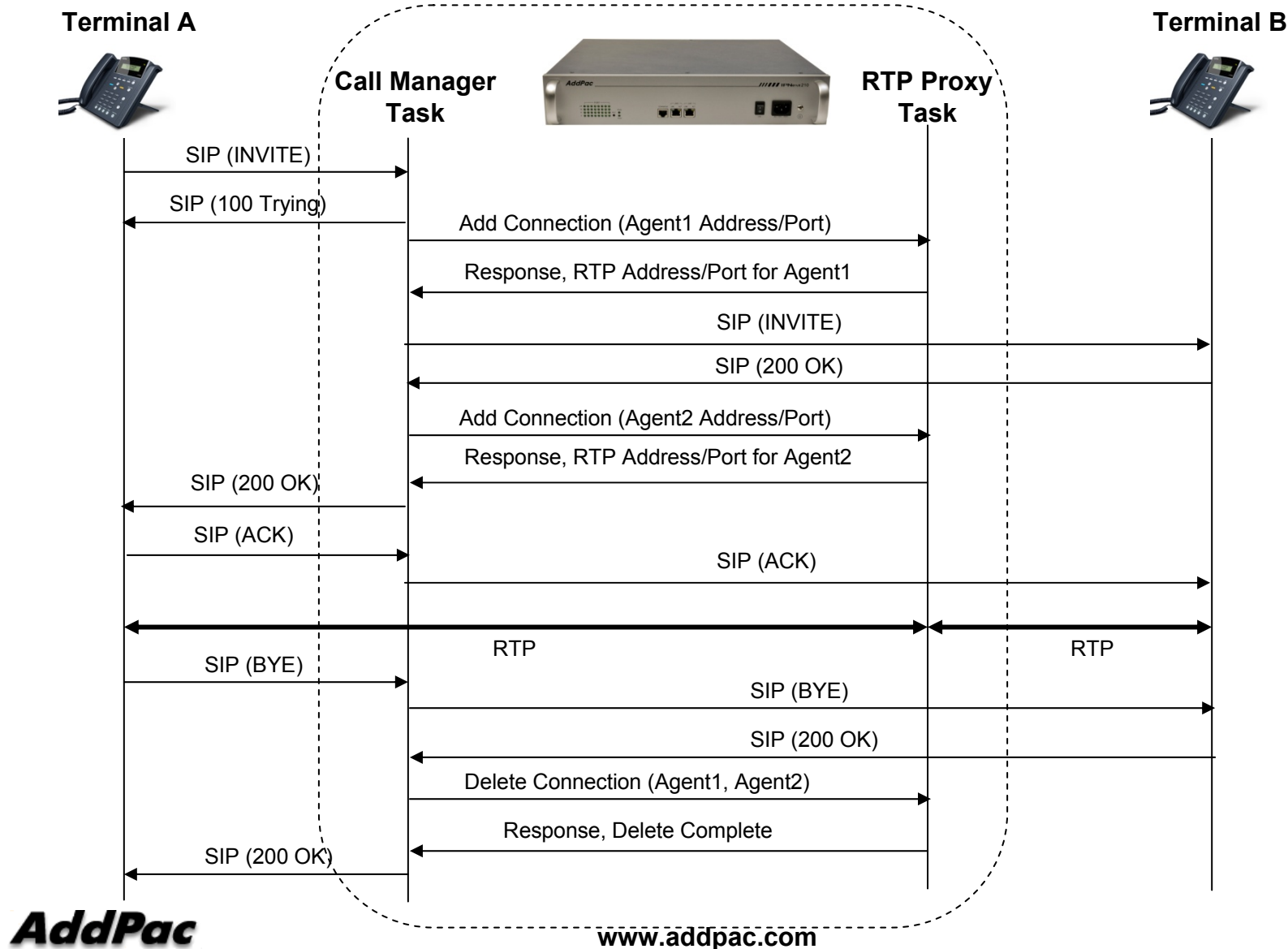

# RTP Proxy Control Message

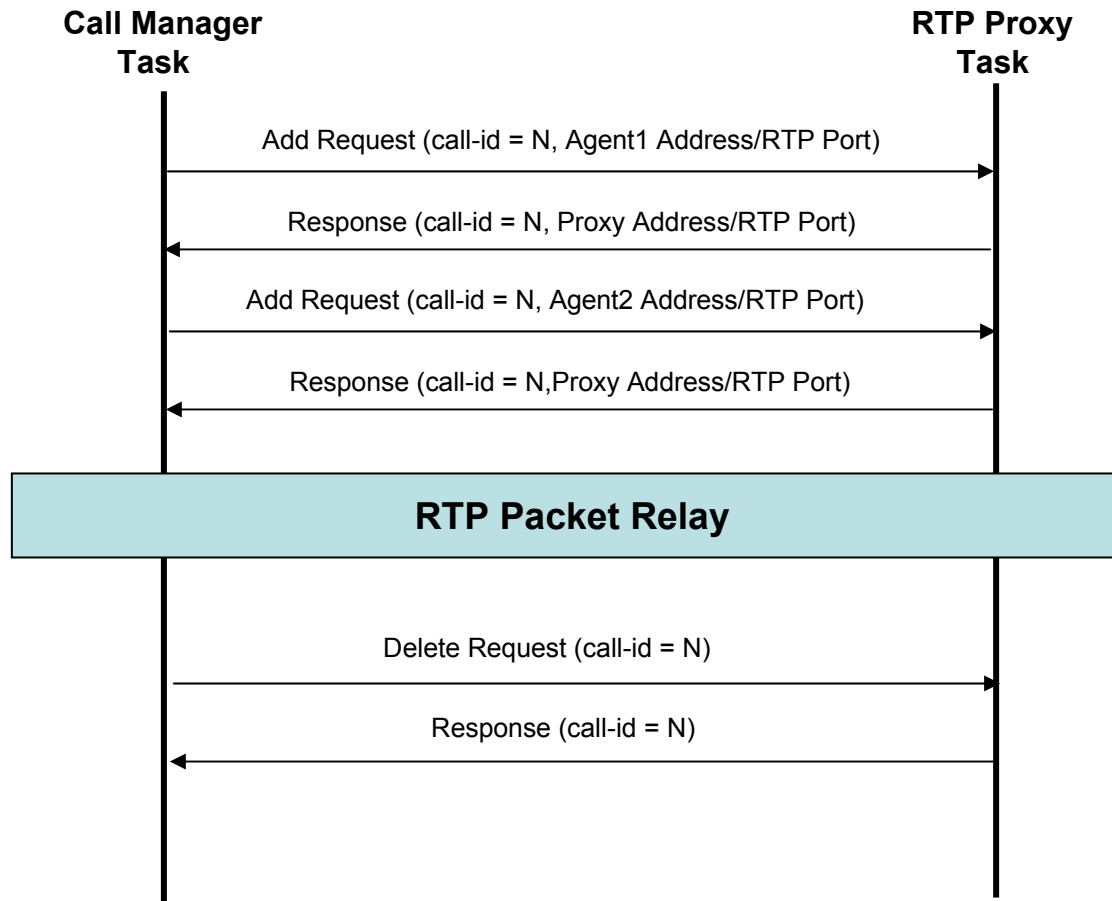



# Thank you!

**AddPac Technology Co., Ltd.**  
Sales and Marketing

Phone +82.2.568.3848 (KOREA)

FAX +82.2.568.3847 (KOREA)

E-mail [sales@addpac.com](mailto:sales@addpac.com)