

AP-EIP60L

Emergency Call IP Phone

High Performance Emergency Call IP Phone Solution

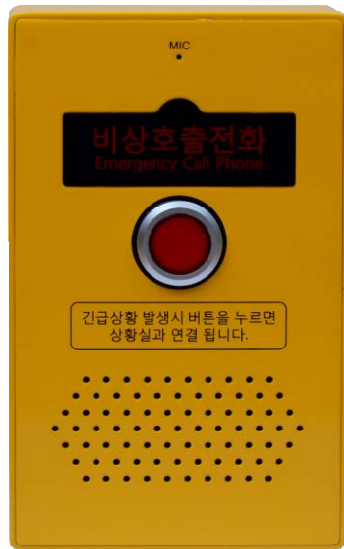

Product Overview

AddPac

AddPac Technology

Sales and Marketing

www.addpac.com

Contents

- Product Overview
- Hardware Specification
- Software Service
- Audio & Voice Service and Features
- Network Service and Features
- Application Area
- Ordering Information



Product Overview

AP-EIP60L Emergency Call IP Phone

- High Performance Emergency Call IP Phone Solution
- Emergency Call IP Phone Solution for Indoor Application
- Full Duplex Voice Communication
- One(1) 10/100Mbps Fast Ethernet
- PoE(Power over Ethernet) Support
- High Quality Speaker Phone Features
- SIP VoIP Signaling Stack Embedded
- Powerful Acoustic Echo Canceller Chip Embedded
- Powerful Network Protocols (PPPoE, DHCP, Static Routing, etc)
- Firmware Upgradeable Architecture
- Advanced Voice QoS Mechanism

Product Highlights

AP-EIP60L Emergency Call IP Phone

Emergency Call IP Phone Solution

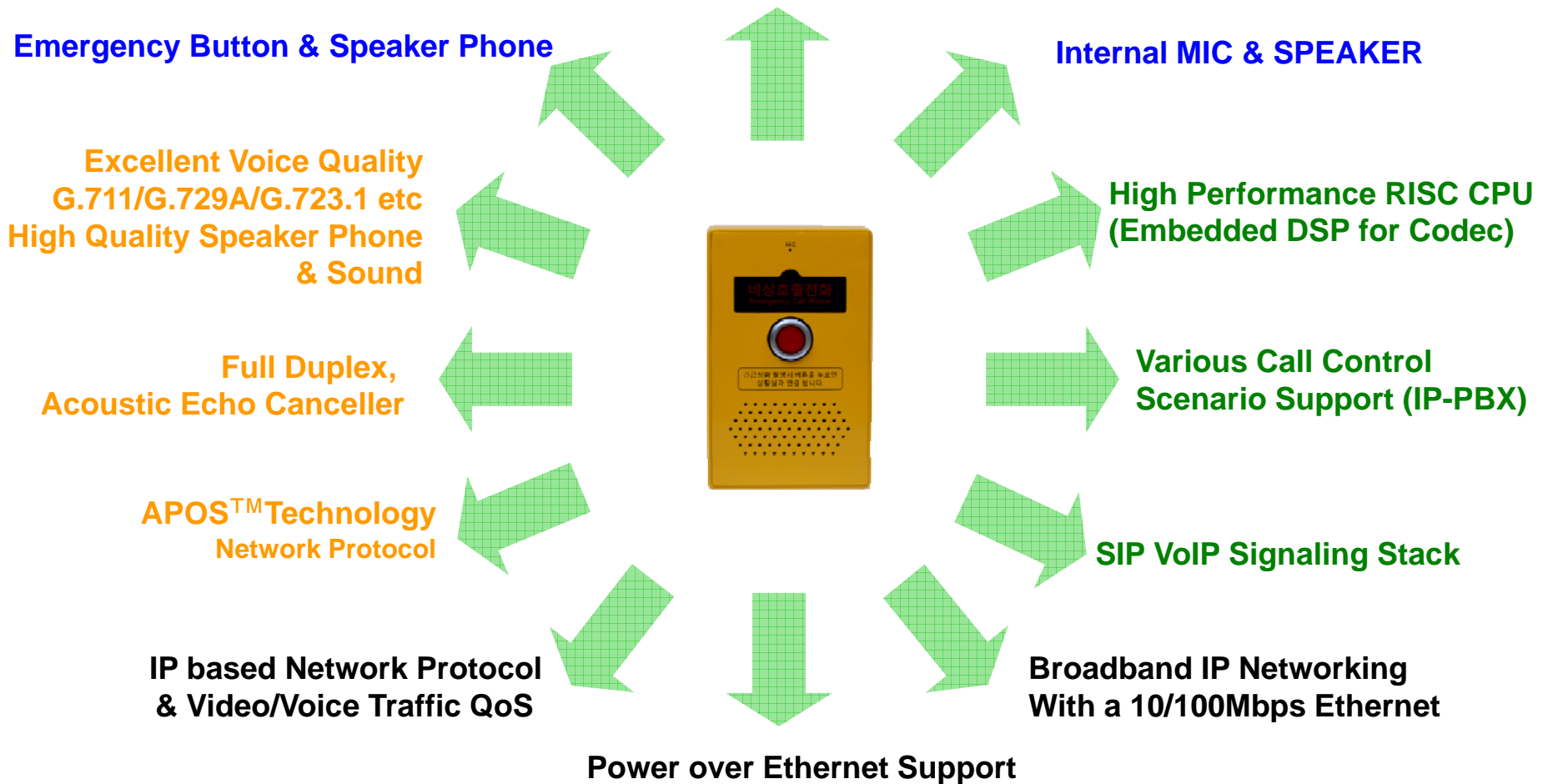

Multimedia Service

AP-EIP60L Emergency Call IP Phone

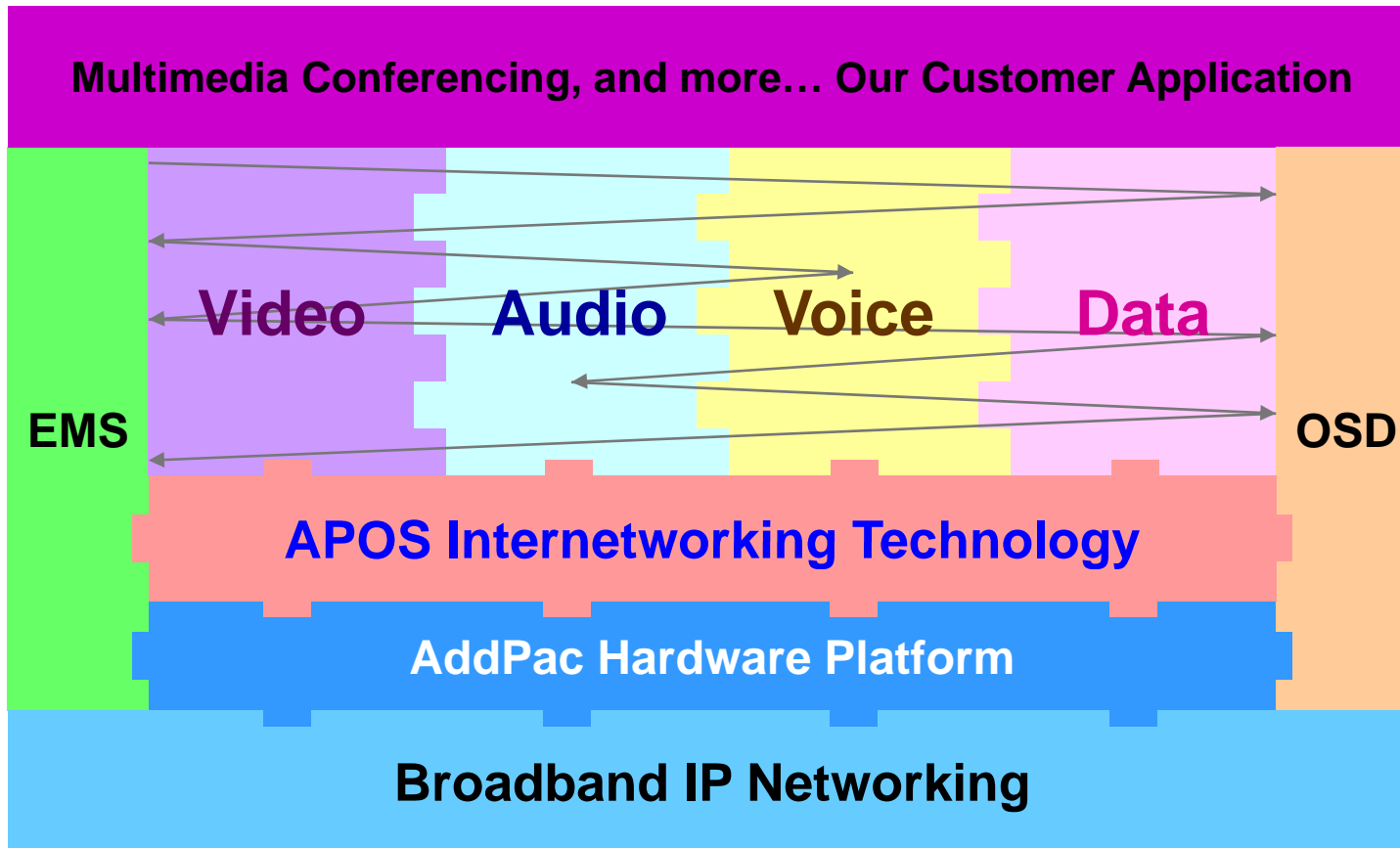

- APOS : AddPac Internetworking Operating System
- OSD : On- Screen Display
- EMS : Element Management System

Hardware Specification

AP-EIP60L Emergency Call IP Phone

- RISC+DSP Microprocessor Computing Power
- Audio and Voice Interface
 - Internal MIC
 - Internal Speaker
- Emergency Call Button & LAMP
- Network Interface
 - One(1) 10/100Mbps Fast Ethernet
- Power Supply
 - Power over Ethernet (Option)
 - External Power Adaptor

Hardware Specification

AP-EIP60L Emergency Call IP Phone

Front Side

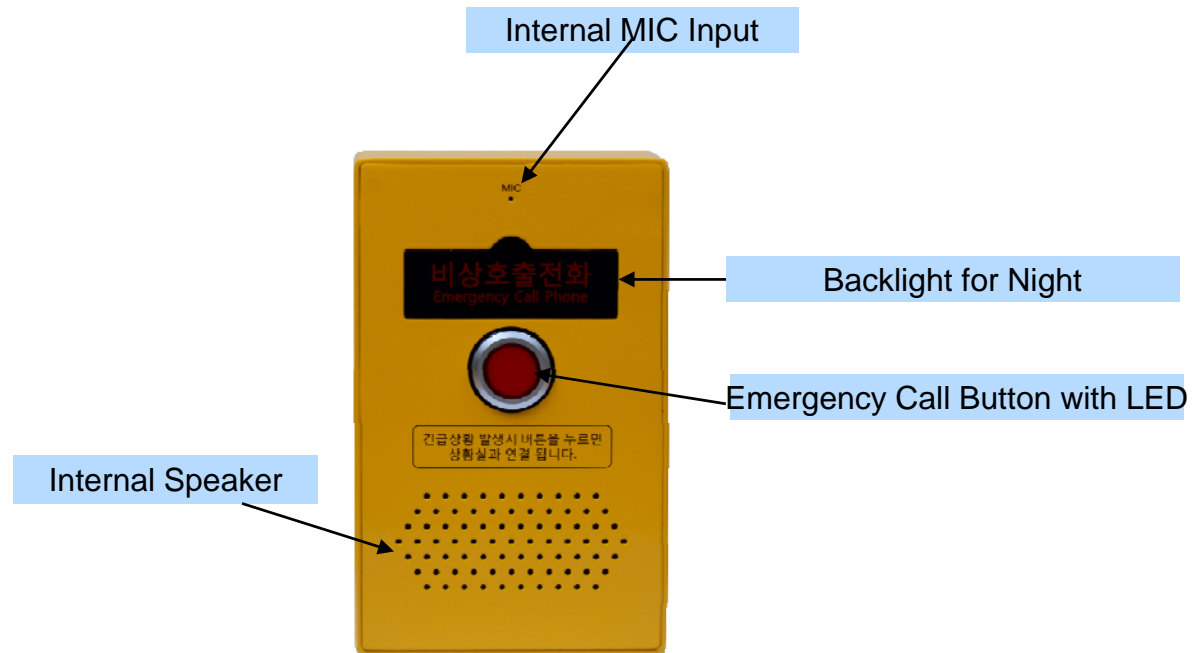

Hardware Specification

AP-EIP60L Emergency Call IP Phone

Back Side

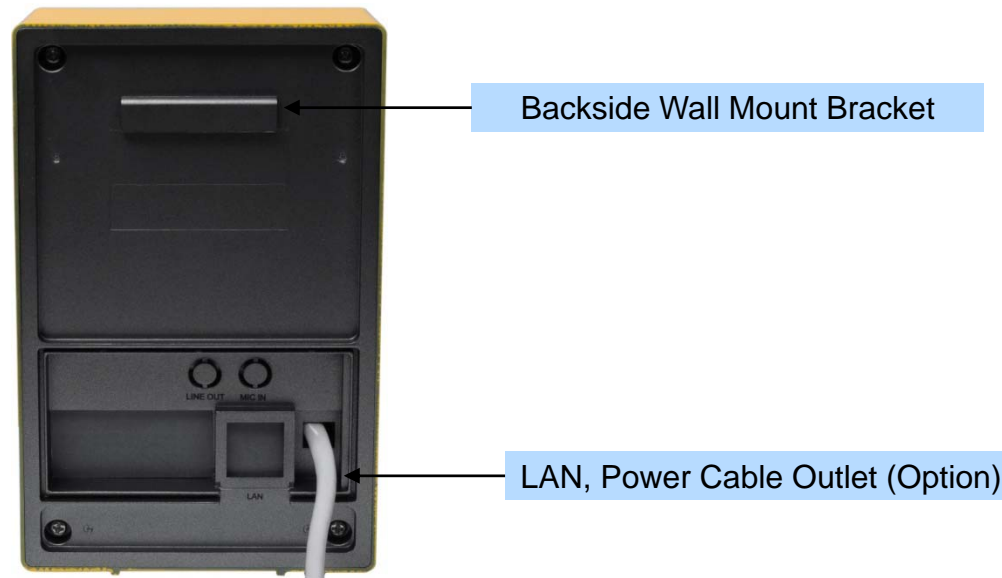

Hardware Specification

AP-EIP60L Emergency Call IP Phone

Power Supply

Terminal Block



12V 1A Power Adaptor

Example



Software Service

AP-EIP60L Emergency Call IP Phone

- Built-in AddPac APOS Internetworking Software
 - Scalability, Functionality, and Stability Features
 - Audio Traffic QoS Control
- Programmable Video, Audio, and Voice Services
 - Audio, and Voice Codec
- Firmware Upgradeable Architecture
- Industry Standard IP based Network Protocol Features

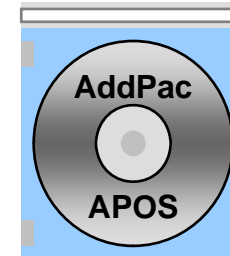

Network Service and Features

AP-EIP60L Emergency Call IP Phone

- Network Managements
 - Standard SNMP Agent (MIB v2) Support
 - Remote Management using Console, Telnet
 - Web based Management using HTTP Server Interface
- Security Functions
 - Standard & Extended IP Access List
 - Enable/Disable for Specific Network Protocols
 - Multi-level User Account Management
 - Auto-disconnect for Telnet/Console Sessions
 - PPP User Authentication Supports (PAP & CHAP)
- Operation & Managements
 - System Performance Analysis for Process, CPU, Connection Interface
 - Debugging, System Auditing, and Diagnostics Support
 - System Booting and Auto-rebooting with Watchdog Feature
 - System Managements with Data Logging
 - IP Traffic Statistics with Accounting

Network Service and Features

AP-EIP60L Emergency Call IP Phone

- Network Managements
 - DHCP Server & Relay Functions
 - Network Address Translation (NAT) Function
 - Port Address Translation (PAT) Function
 - Transparent Bridging (IEEE Standard) Function
 - Spanning Tree Bridging Protocol Support
 - Remote Bridging Support
 - Concurrent Routing and Bridging Support
 - Cisco Style Command Line Interface (CLI)
 - Network time Protocol (NTP) Support

Emergency Call Center Application

AP-EIP60L Emergency Call IP Phone

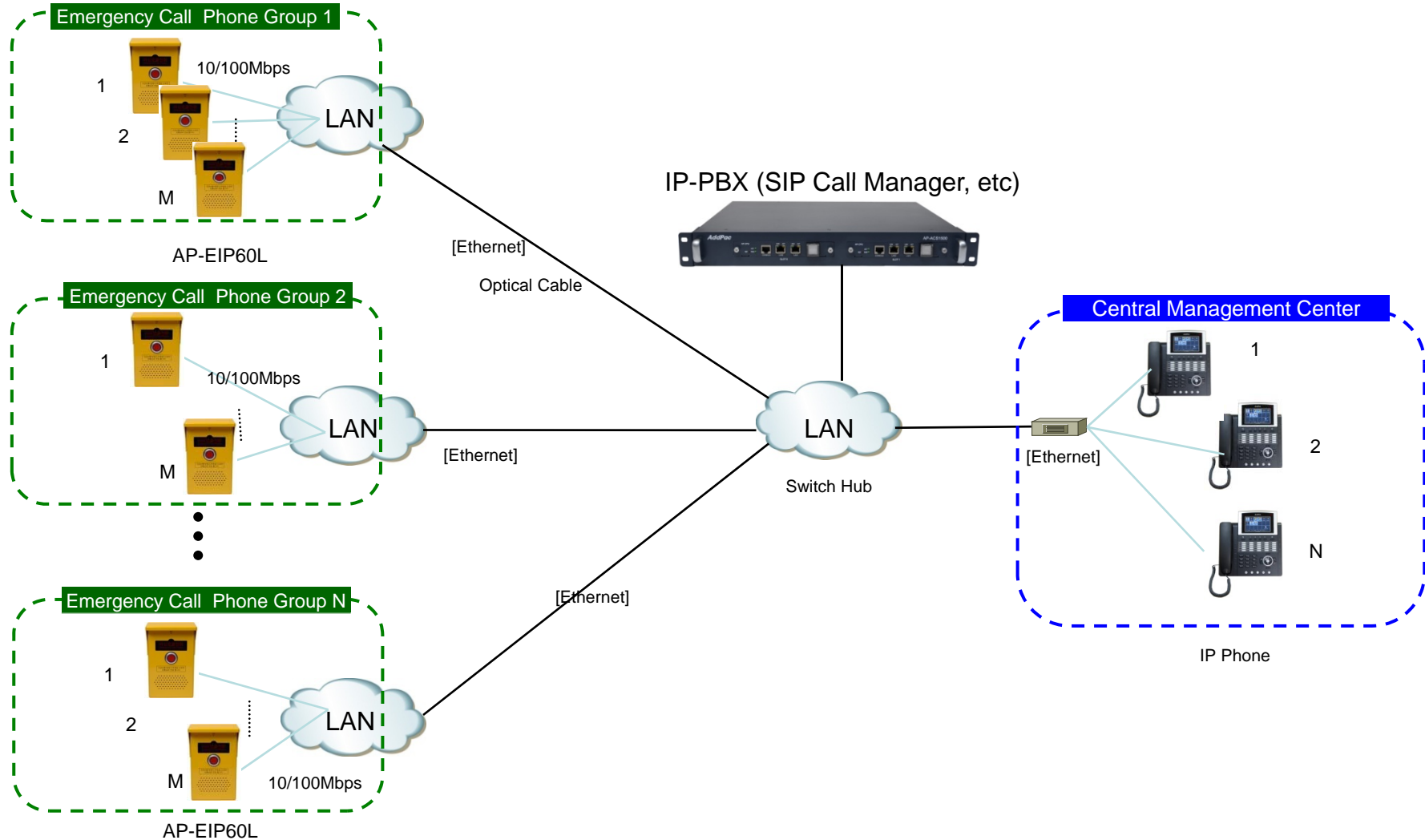

Ordering Information

- AP-EIP60L Emergency Call IP Phone Hardware
 - AP-EIP60L Emergency Call IP Phone Main Body
 - RISC Microprocessor with Embedded DSP Architecture
 - Internal Speaker, MIC
 - Emergency Call Button
 - One(1) 10/100Mbps Fast Ethernet
- Built-in APOS Internetworking Software for AP-EIP60L
- Including 1 Year Hardware Warranty
- Product Documents
 - Install and Operation Guide (PDF)
- Pricing
 - AddPac Technology Regional Sales Manager
 - Authorized Sales and Marketing Representatives
 - Please Contact www.addpac.com



Thank you!

AddPac Technology Co., Ltd.
Sales and Marketing

Phone +82.2.568.3848 (KOREA)

FAX +82.2.568.3847 (KOREA)

E-mail sales@addpac.com