



IPNext 600™ NGN IP-PBX

High-performance Next Generation IP-PBX Solution

Preliminary Product Overview

(Without notice, following described technical spec. can be changed)



AddPac

AddPac Technology

2009, Sales and Marketing

Contents

IPNext 600 Next Generation IP-PBX System

- Product Overview
- Hardware Specification
- System Redundancy Features
- Software Service
- IP Telephony Service and Features
- RTP Proxy Service
- User Presence Service
- Network Service and Features
- User Terminals
- Application Area
- Ordering Information



Product Overview

IPNext 600 Next Generation IP-PBX System

- SIP Application Server, Proxy, Registrar and Location Server
- Multiple ITSP Trunk with SIP & H.323 Accounts Support
- Dual System Redundancy Architecture
 - Two(2) Fast Ethernet Interface / System
- High Performance RISC Architecture
- Powerful Network Protocols (PPPoE, DHCP, Static Routing, etc)
- IPv4/IPv6 Dual Stack
- RTP Proxy Function Embedded for Private IP and IPv6 Address Interworking
- User Presence Service Features for Smart Multimedia Messenger and Smart IP Phone
- IVR Scenario Editor, Voice Mail, Media Service (Coloring), Conference
- Firmware Upgradeable Architecture
- Smart Multimedia Manager for IP-PBX Management
- Smart Messenger Service (click to dial) for Unified Communication
- VPMS (VoIP Plug&Play Management System) & Smart NMS for Large Scale Deployment
- Advanced Voice QoS Mechanism
- Dual Redundancy Power Module

Product Highlights

IPNext 600 Next Generation IP-PBX System

IP based Advanced IP-PBX

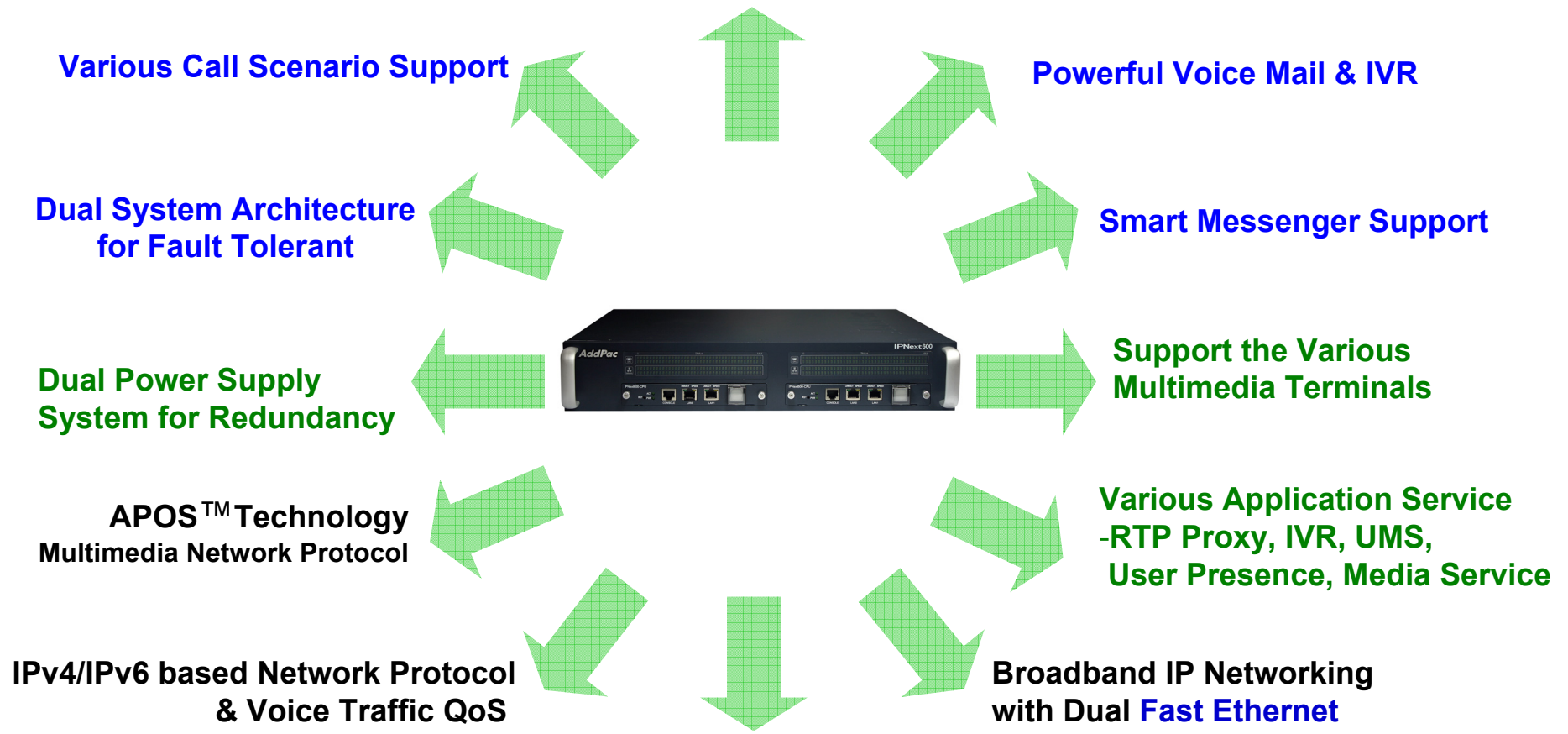

AddPac

www.addpac.com

Hardware Specification

IPNext 600 Next Generation IP-PBX System

A square logo with a dark blue background and a white border. The text "RISC" is positioned above "CPU" in white, sans-serif, uppercase letters.

RISC
CPU

- 64bit High-End Microprocessor Computing Power
- Main Chassis
 - Dual Redundancy CPU Boards for System Fault Tolerant
 - Two(2) 10/100Mbps Gigabit Ethernet
 - One(1) RS-232C Console (RJ45)
 - Dual Redundancy Power Supply Module
 - Hot-Swap Features

Hardware Specification

IPNext 600 Next Generation IP-PBX System

RISC
CPU

IPNext 600 Front Side

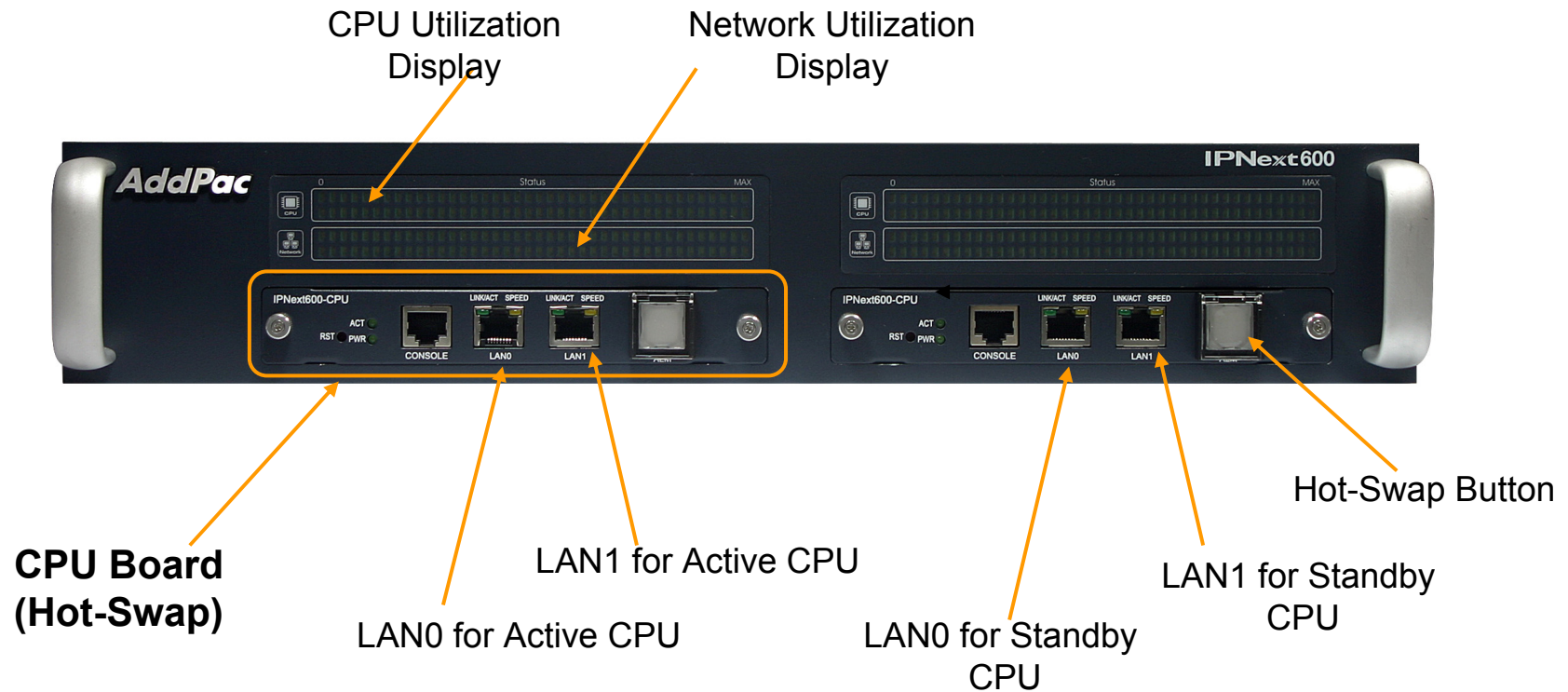

Hardware Specification

IPNext 600 Next Generation IP-PBX System



IPNext 600 Back Side

Dual Power Supply Modules
(Hot-Swap)



PSU Module A

PSU Module B

Power On/Off Switch
for System

System Redundancy Features

IPNext 600 Next Generation IP-PBX System

IPNext600 System Block Diagram

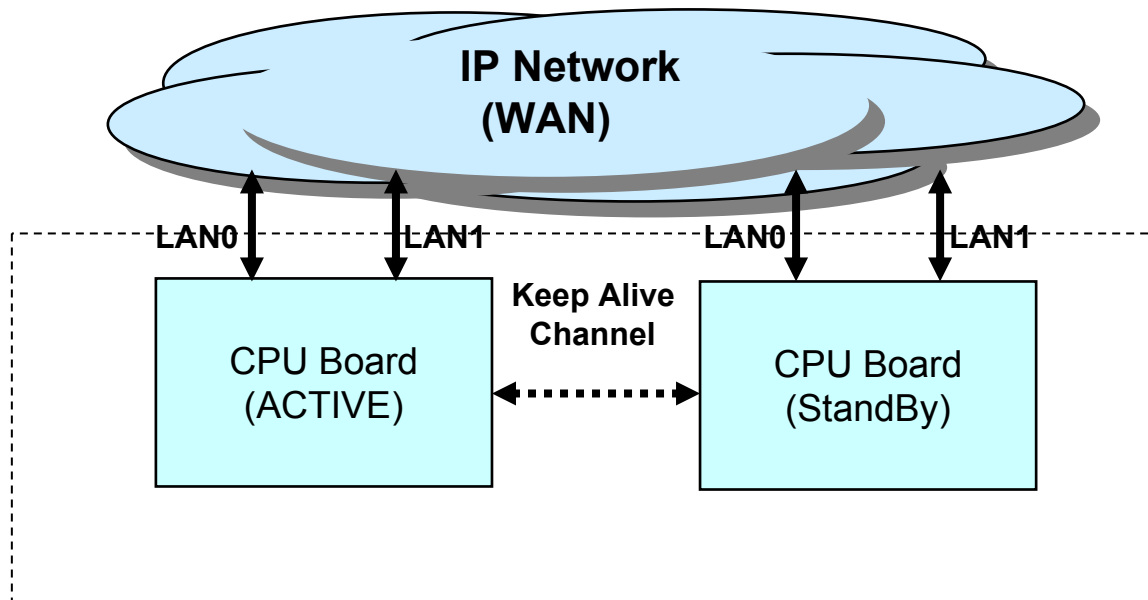

System Redundancy Features

IPNext 600 Next Generation IP-PBX System

- Active– Active Duplication Scheme
- Active – Standby Duplication Scheme
- VRRP based Duplication Scheme

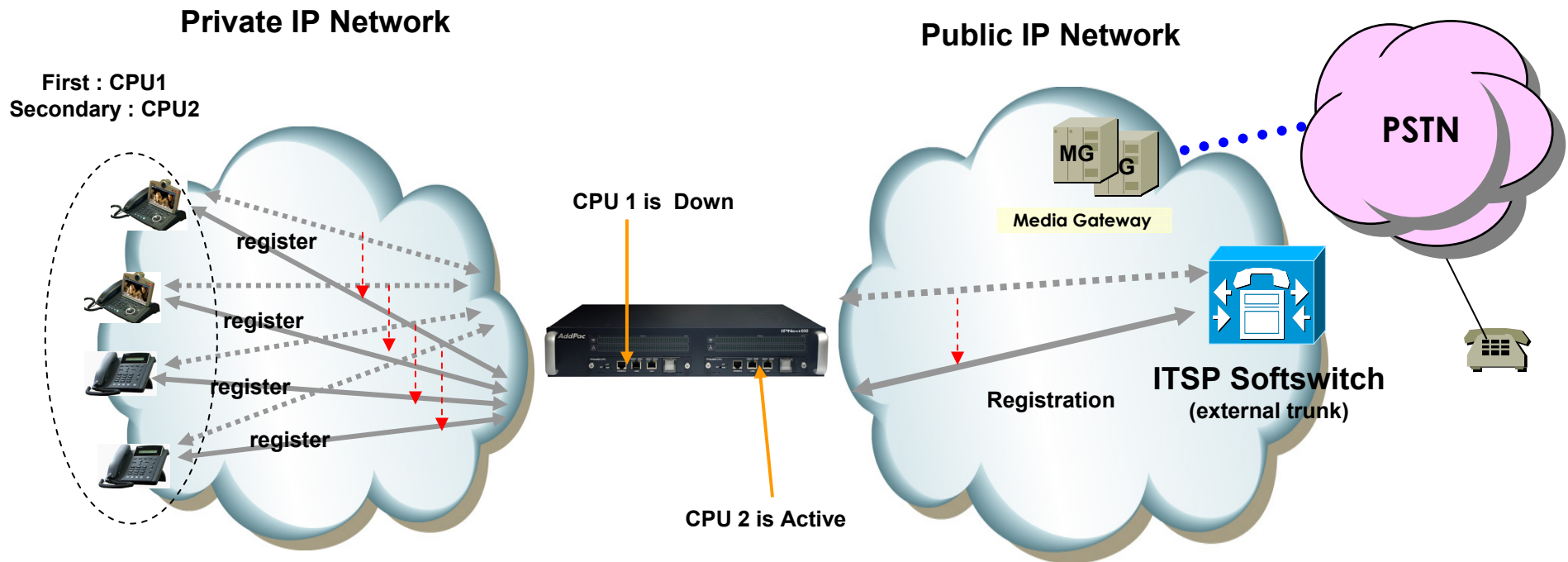

Active – Standby Duplication Scheme (example)

Software Service

IPNext 600 Next Generation IP-PBX System

- **Built-in AddPac APOS Internetworking Software**

- Scalability, Functionality, and Stability Features
- Advanced IP-PBX Call Manager Features
- QoS Control Features

- **Programmable Video, Audio, and Voice Services**

- Audio, Video and Voice Codec

- **Firmware Upgradeable Architecture**

- **Industry Standard Network Protocol Features**

- **Highly User Friendly Management Features**

- PC based Smart Messenger
- Smart Multimedia Manager for Operation & Management

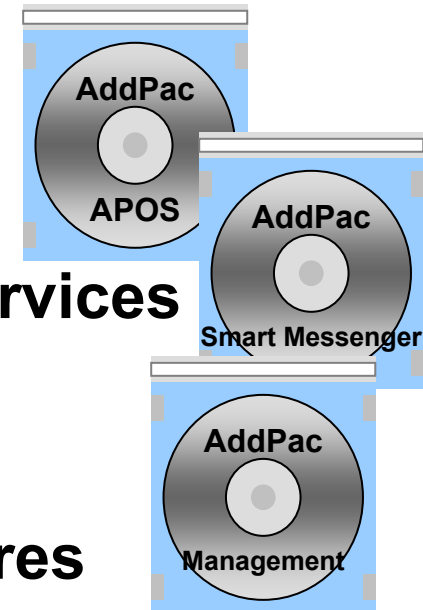

IP-PBX Software Components

IPNext 600 Next Generation IP-PBX System

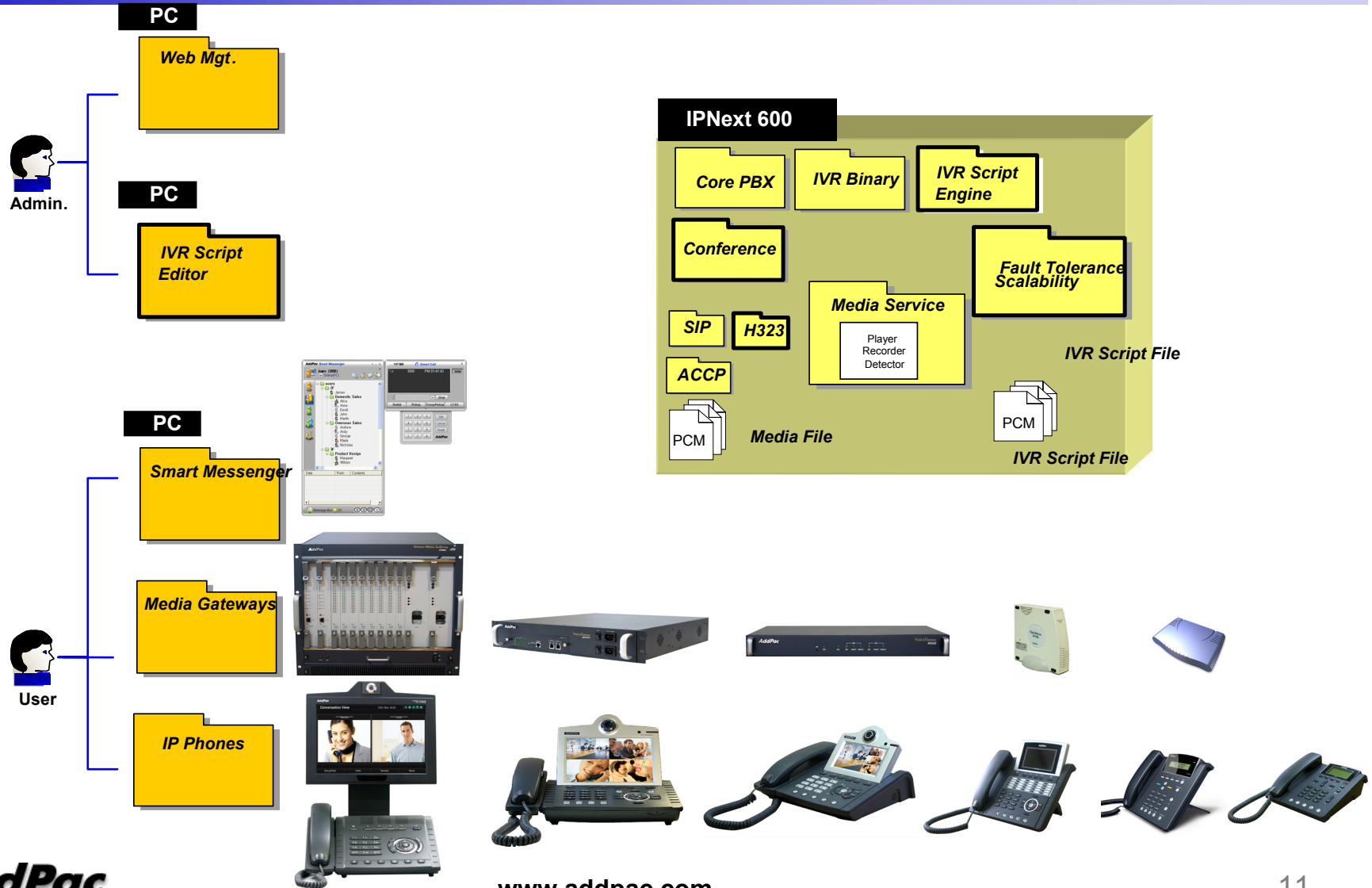

AddPac

www.addpac.com

IP Telephony Service and Features

IPNext 600 Next Generation IP-PBX System

- **Signaling Server**

- SIP Application Server, Proxy, Registrar and Location Server (RFC3261)
- Multiple ITSP Trunk with SIP & H.323 Accounts Support
 - IP UA Client Role for Registering to ITSP SIP Server
 - H.323 Gatekeeper Client Role for Registering to ITSP H.323 Gatekeeper Server

- **IVR & Auto Attendant**

- Default Auto Attendant Support
- Interactive Voice Response (IVR)
 - Provides with GUI-based Smart IVR Scenario Editor
 - Upload/Download Scenario by Smart IVR Scenario Editor
 - Supports Multiple Concurrent Scenarios
 - Supports Recordable IVR Prompts

- **Voice Mail**

- Support Voice Mail with IVR
- Access from Remote Site via Trunk Support
- Voice Mail Notification Support

IP Telephony Service and Features

IPNext 600 Next Generation IP-PBX System

- **Number & Call Routing**

- Trunk Hunting by Preference or Sequential
- Call Hunting by Preference, Simultaneous, Random
- Call Hunting by Chained Hunting Group
- Partition for Address Grading
- Call Class for Call Access Control
- Number Translation Rule for Inbound/Outbound Call
- Centrex with Prefix Support
- Multiple Shared Devices with One Number
- Multiple Numbers on One Device
- Individual Call Park within Park Number Pool
- Group Call Park within a Group or Other Group
- Call Pickup of Ringing Call of Same Group or Other Group
- Call Pickup of Parked Call
- Call Transfer - Blind, Consult
- Call Forwarding - Unconditional, Busy, No Answer, Voice Mail
- Call Waiting
- Call Swaping
- Call Hold

IP Telephony Service and Features

IPNext 600 Next Generation IP-PBX System

- **IP-PBX Advanced Features with AddPac IP Phones**

- Multiple Call Handling with Call Status and Calling Line Number and Name
- Plug and Play with Auto Discovery Function
- Softkey Map Download and Control
- Time and Date Setting
- Voice Mail List View
- Parked Call List View
- Call Forward Setting
- Recent Call List View
- Calling Number and Name Identification
- Individual Call Park within Park Number Pool by Softkey
- Group Call Park within a Group or Other Group by Softkey
- Call Pickup of Ringing Call of Same Group or Other Group by Softkey
- Call Pickup of Parked Call by Softkey
- Call Transfer - Blind, Consult by Softkey
- Call Waiting Indication
- Call Swaping by Softkey
- Call Hold by SoftKey
- Conference Control

IP Telephony Service and Features

IPNext 600 Next Generation IP-PBX System

- **User & Device Management**
 - LDAP (Light weight Directory Access Protocol) Support
 - Supports Hierarchical Organization
 - Auto Discovery of IP Phones & Video Phones
 - Monitoring Status of Phones
- **Miscellaneous***
 - Distinctive Ring by Calling User
 - Auto Config & Upgrade
 - Personal Directory
 - Downloadable Ring
 - Do not Disturb



IP Telephony Service and Features

IPNext 600 Next Generation IP-PBX System

- **Conference**

- G.711 (4-party Conference, 2 session) : Basic
- Ad-hoc Conference
- Dial-Out Conference
- Meet-me Conference
- Multiple External MCU support(Video, Audio, etc) : AddPac AP-MC1000, etc
- Conference Chair and Participants Management

- **Music & Announcement**

- Music on Hold
- Replaceable Announcements
- Dialing Music / Tone Service

IP Telephony Basic Call Scenario

IPNext 600 Next Generation IP-PBX System

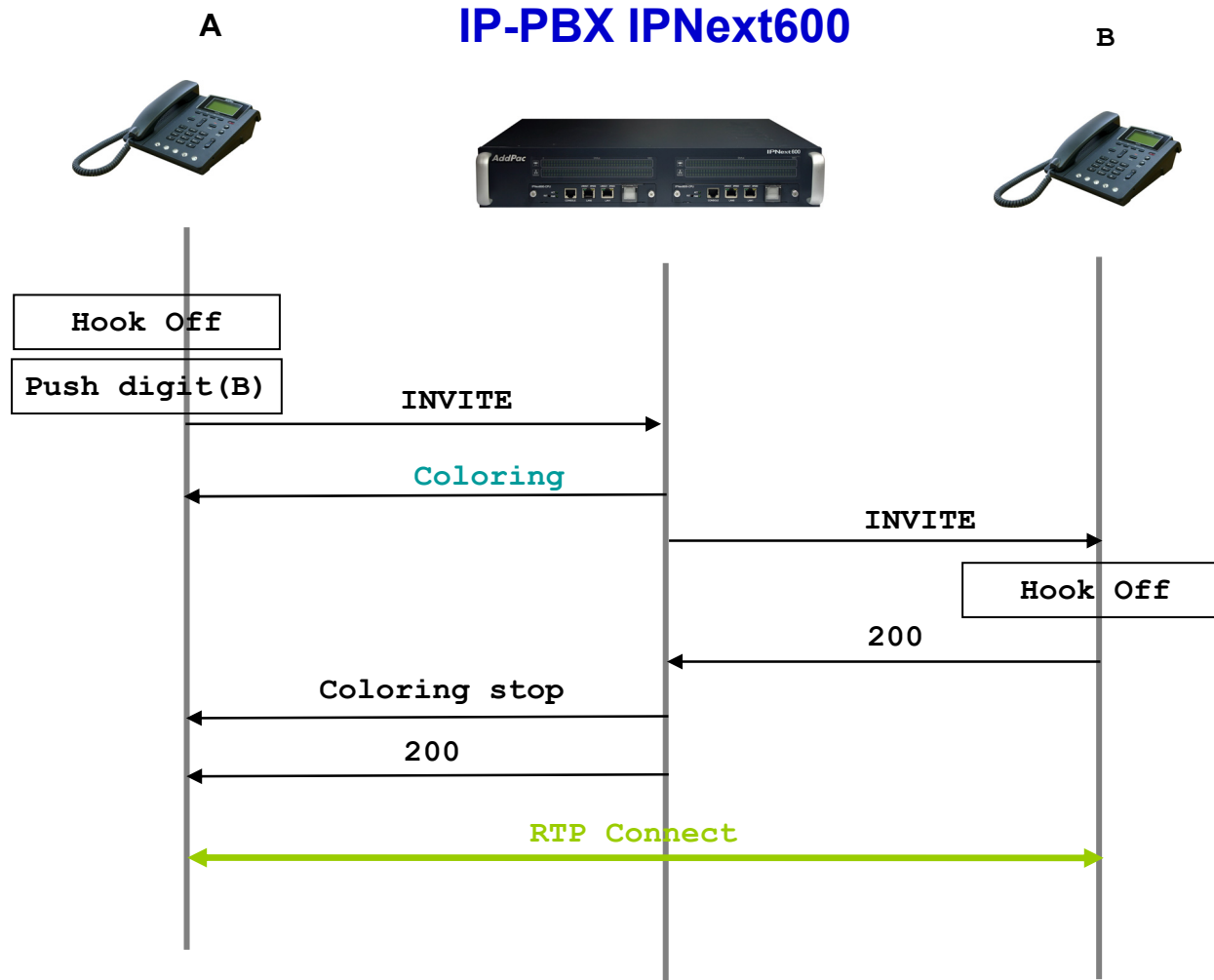

RTP Proxy Service

IPNext 600 Next Generation IP-PBX System

Public/Private RTP Proxy
without NAT Router

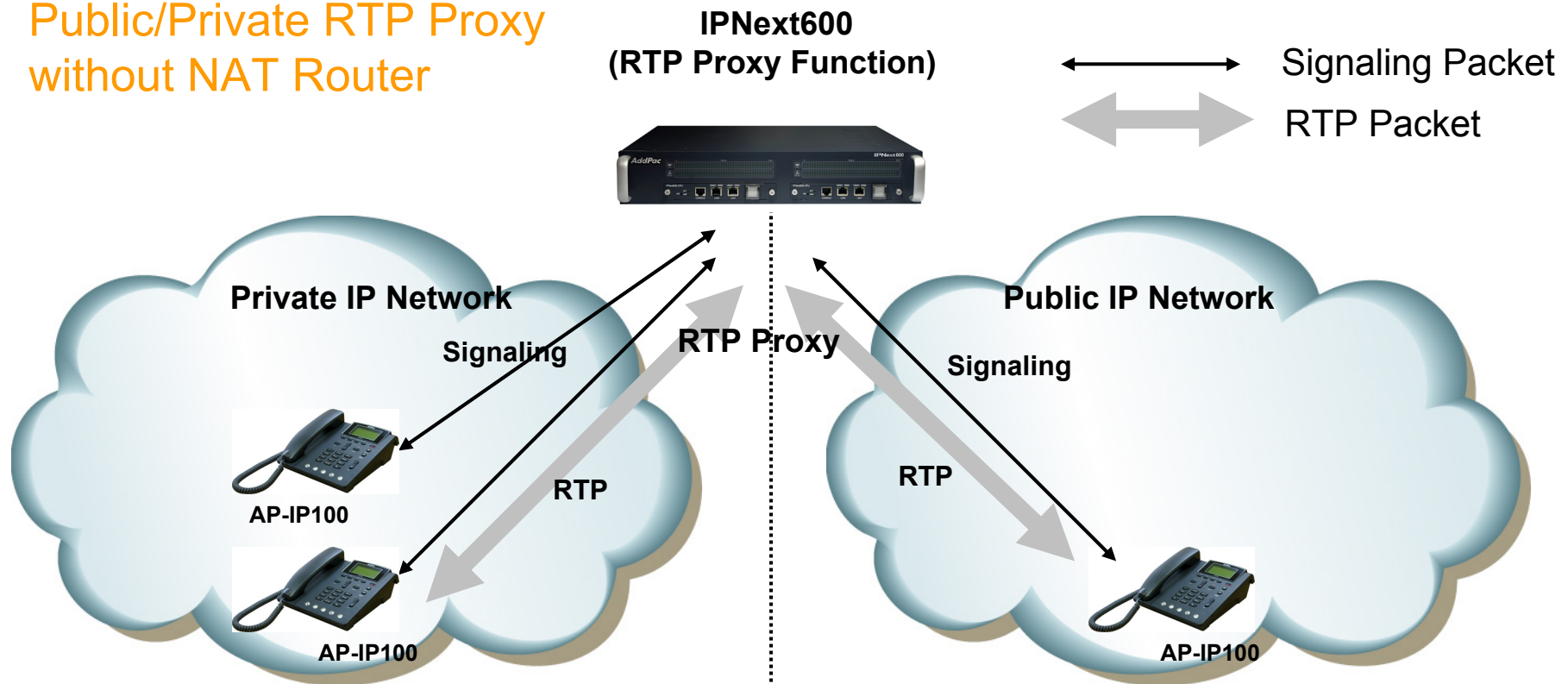

- Located between public and private network
- IPNext 600(Call manager + RTP proxy) has public and private address
- IPNext 600 determine that the call is internal or external

RTP Proxy Service

IPNext 600 Next Generation IP-PBX System

Asymmetric/Symmetric NAT

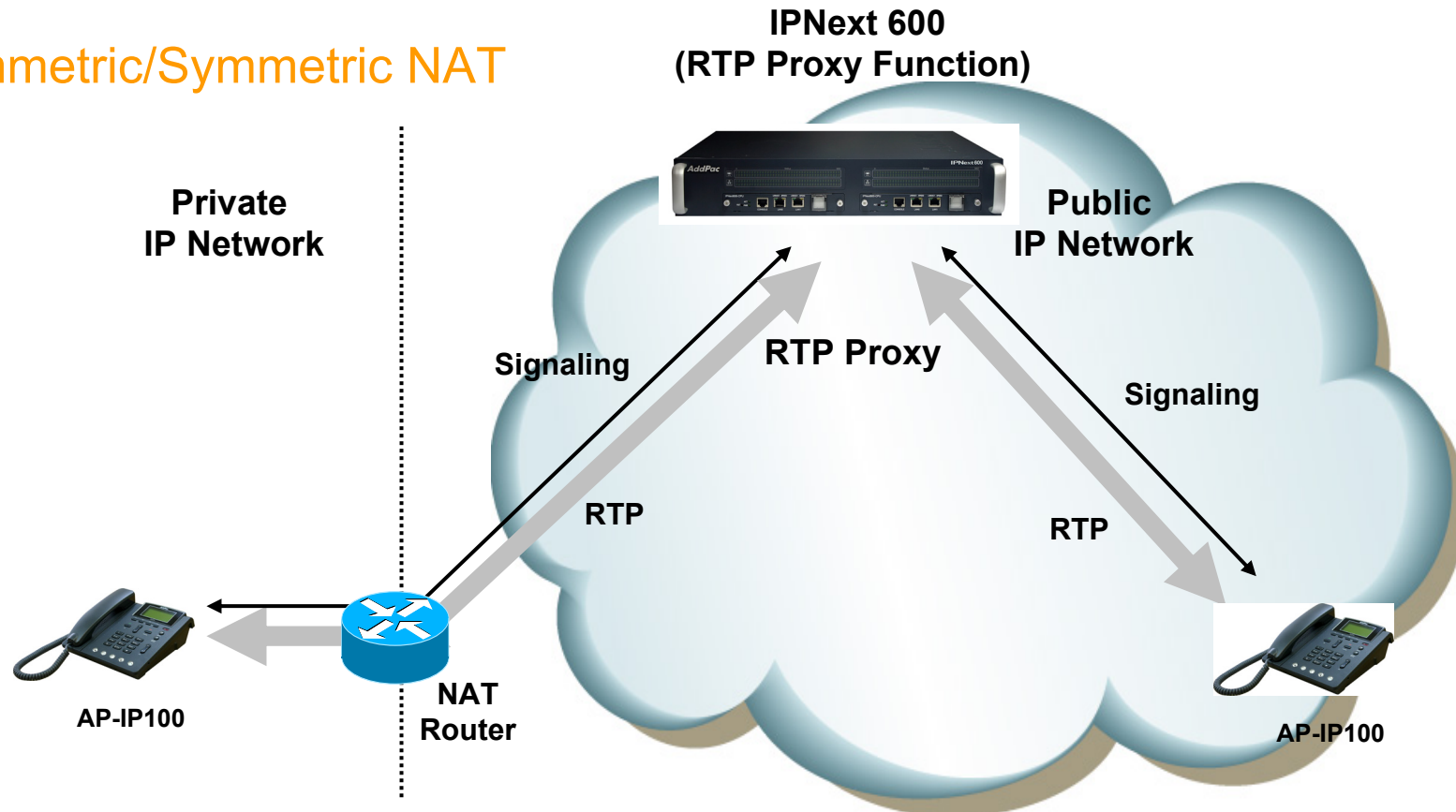

- Located in public network
- RTP Proxy has single public address
- Auto detect for asymmetric NAT via incoming RTP packet

RTP Proxy Service

IPNext 600 Next Generation IP-PBX System

RTP Proxy Communication between Private IP

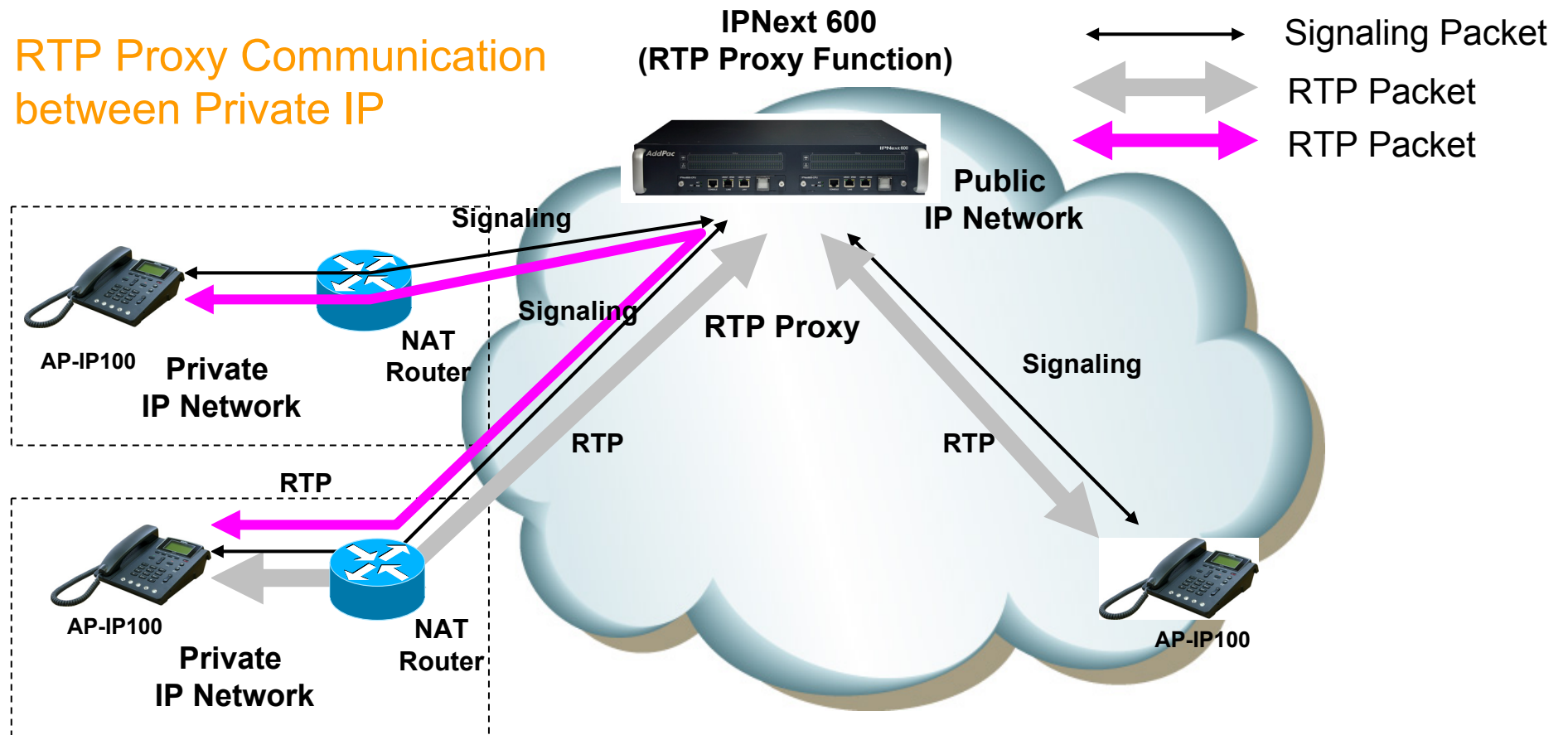

- Located in public network
- RTP Proxy has single public address
- Auto detect for asymmetric NAT via incoming RTP packet

RTP Proxy Service

IPNext 600 Next Generation IP-PBX System

IPv4/IPv6 RTP Proxy

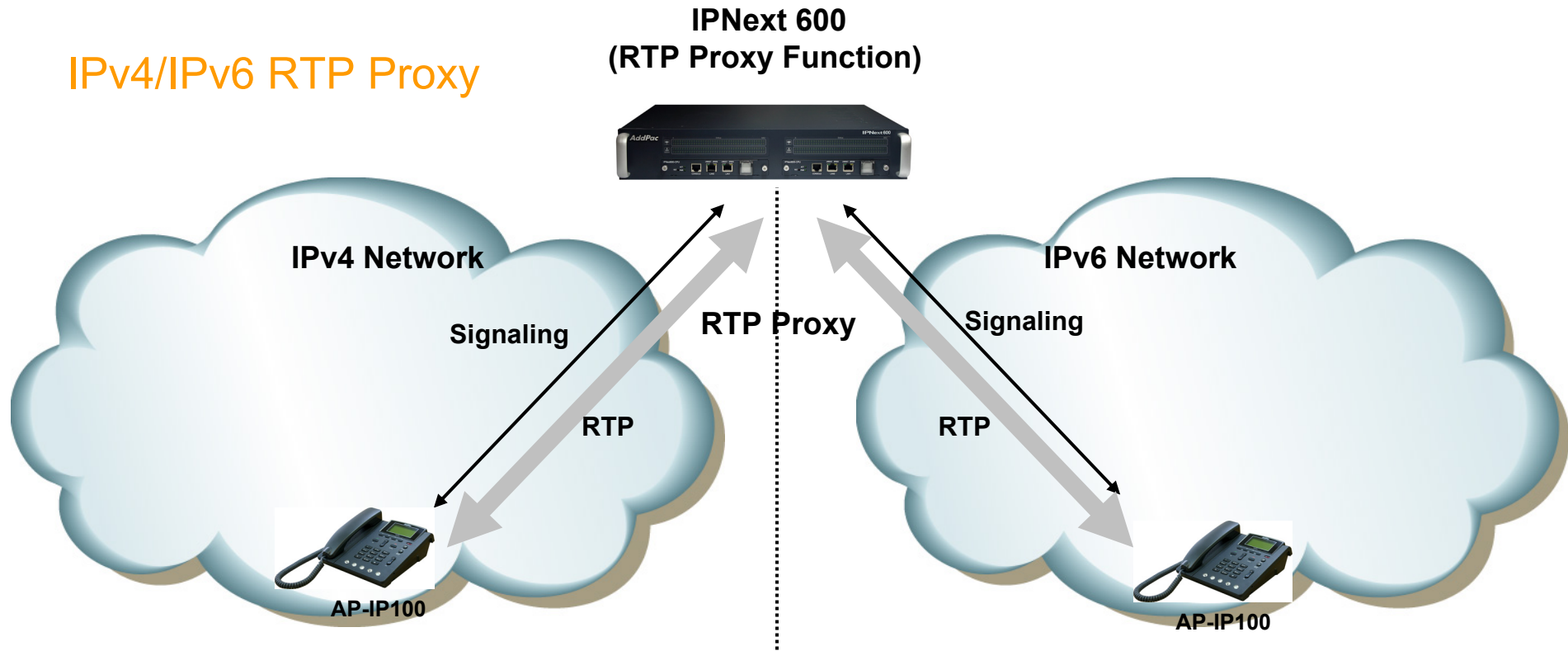

- IPNext 600(Call manager + RTP proxy) has IPv4 and IPv6 address

User Presence Service for UC

IPNext 600 Next Generation IP-PBX System

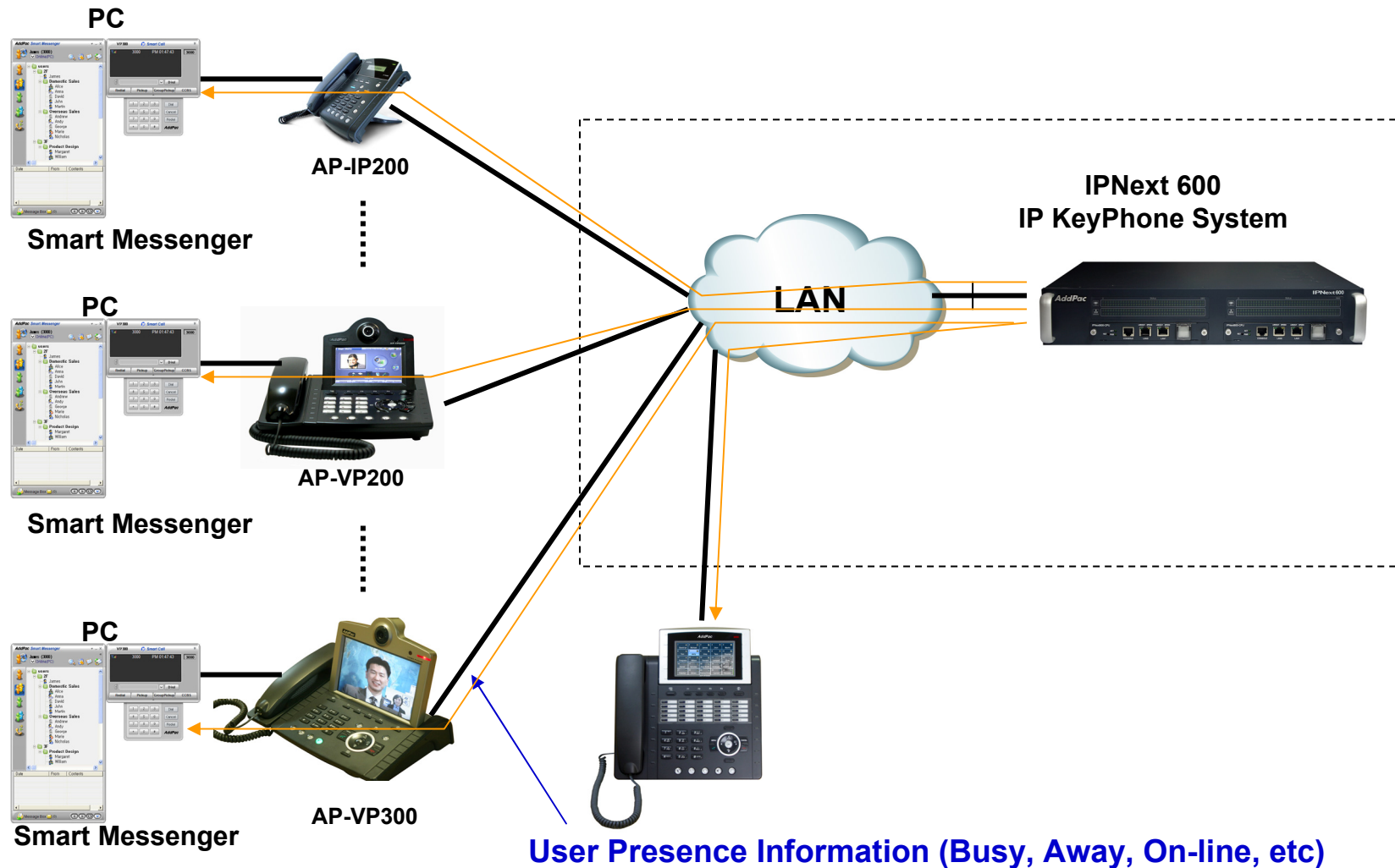

Network Service and Features

IPNext 600 Next Generation IP-PBX

Basic Network Protocols

- ARP, IP, IPv6, TCP, UDP, ICMP, ICMPv6, SCTP, IGMP, MLD

Routing Protocol

- IPv4 : Static
- IPv6 : Static

Service Protocol

- FTP, Telnet, TFTP, DHCP Server/Relay, SNMP Server
- CDP (Cisco Discovery Protocol)
- DNS Resolver , DDNS(nsupdate)
- Bridge
- Syslog
- IP/IPv6 policy control (QoS)
- VPDN (Virtual Private Dial-up Network : L2TP Server)

Network Service and Features

IPNext 600 Next Generation IP-PBX

IPv4/IPv6 Interworking

- NAT/PAT for IPv4
- IP connect (formerly ip-share) and device cascade for IPv4
- IP/IP, IP/GRE tunneling
- NAT-PT
- 6to4, Autoconfig tunneling

IPv4 Address Configuration

- Fixed (Static)
- DHCP
- PPPoE

IPv6 Address Configuration

- Fixed (Static)
- EUI-64
- Autoconfig (Neighbor Advertisement and Solicitation)

Network Service and Features

IPNext 600 Next Generation IP-PBX

Miscellaneous

- Standard & Extended IPv4/IPv6 Access List
- Multi-level User Account Management
- IP accounting
- fsh (Embedded file system shell)
- STUN Client

Network Service and Features

IPNext 600 Next Generation IP-PBX

SNMP MIBs

- MIB-II
- RMON MIBs (Statistics, History, Alarm, Hosts Group)
- RFC2465 Management Information Base for IP Version 6: Textual Conventions and General Group
- RFC2466 Management Information Base for IP Version 6: ICMPv6 Group
- RFC2452 IP Version 6 Management Information Base for the Transmission Control Protocol
- RFC2454 IP Version 6 Management Information Base for the User Datagram Protocol
- AddPac Enterprise MIBs
- etc

User Terminals

IPNext 600 Next Generation IP-PBX System

- AP-VP500 Video Phone
- AP-VP300 Video Phone
- AP-VP280 Video Phone
- AP-VP250 Video Phone
- AP-VP150 Video Phone
- AP-VP120 Video Phone
- AP-IP300 IP Phone
- AP-IP150 IP Phone
- AP-IP120 IP Phone
- AP-IP90 IP Phone
- AP-PT100 User Presence Terminal
- AP-WP100 WiFi IP Phone
- AP-SMP100 Soft Phone
- Smart Messenger for UC



AP-IP120



AP-VP300



AP-VP120



AP-VP150



AP-VP280



AP-IP150



AP-IP300



AP-WP100

AP-VP500 Video Phone

IPNext 600 Next Generation IP-PBX System

- 12.1 Inch LCD Display, Touch Screen
- External Video Interface
 - Composite (RCA) Video In/Out, S-Video Out,
 - Component Out
- External Audio In/Out
- High-performance Video Codec Support
 - H.263, MPEG-4, JPEG, and H.264
- Powerful Image Resolution Support
 - QCIF(176x144), CIF(352x288), QVGA(320x240), and VGA(640x480)
- Up to 30fps at 1Mbps with VGA-Resolution(MPEG-4)
- Video Conference Call Support (AddPac MCU Inter-working)
- SIP, H.323 Signaling Support
- Rate Control for Video Traffic QoS
 - Ensuring Optimized Quality, Frame Rate with Limited Bandwidth
- High-end Error Resilient Against Various Packet Error



AP-VP300 Video Phone

IPNext 600 Next Generation IP-PBX System

- 7 Inch LCD Display, Touch Screen
- External Video Interface
 - Composite (RCA) Video In/Out, S-Video Out
- External Audio In/Out
- High-performance Video Codec Support
 - H.263, MPEG-4, JPEG, and H.264
- Powerful Image Resolution Support
 - QCIF(176x144), CIF(352x288), QVGA(320x240), and VGA(640x480)
- Up to 30fps at 1Mbps with VGA-Resolution(MPEG-4)
- Video Conference Call Support (AddPac MCU Inter-working)
- SIP, H.323 Signaling Support
- Rate Control for Video Traffic QoS
 - Ensuring Optimized Quality, Frame Rate with Limited Bandwidth
- High-end Error Resilient Against Various Packet Error



AP-VP250 Video Phone

IPNext 600 Next Generation IP-PBX System

- 4.3 Inch LCD Display, Touch Screen
- 25 Speed-Dial Key with Presence Indication LAMP.
- External Video Interface
 - Composite (RCA) Video In/Out, S-Video Out
- External Audio In/Out
- High-performance Video Codec Support
 - H.263, MPEG-4, JPEG, and H.264
- Powerful Image Resolution Support
 - QCIF(176x144), CIF(352x288), QVGA(320x240), and VGA(640x480)
- Up to 30fps at 1Mbps with VGA-Resolution(MPEG-4)
- SIP, H.323 Signaling Support
- Rate Control for Video Traffic QoS
 - Ensuring Optimized Quality
 - Frame Rate with Limited Bandwidth
- High-end Error Resilient Against Various Packet Error



AP-VP150 Video Phone

IPNext 600 Next Generation IP-PBX System

- 4.3 Inch LCD Display
- External Video Interface
 - Composite (RCA) Video Out, S-Video Out
- External Audio In/Out
- High-performance Video Codec Support
 - H.263, MPEG-4, JPEG, and H.264
- Powerful Image Resolution Support
 - QCIF(176x144), CIF(352x288), QVGA(320x240), and VGA(640x480)
- Up to 30fps at 1Mbps with VGA-Resolution(MPEG-4)
- Video Conference Call Support (AddPac MCU Inter-working)
- SIP, H.323 Signaling Support
- Rate Control for Video Traffic QoS
 - Ensuring Optimized Quality
 - Frame Rate with Limited Bandwidth
- High-end Error Resilient Against Various Packet Error



AP-VP120 Video Phone (New)

IPNext 600 Next Generation IP-PBX System

- 4.3 Inch LCD Display
- External Video Interface
 - Composite (RCA) Video Out, S-Video Out
- External Audio In/Out
- High-performance Video Codec Support
 - H.263, MPEG-4, JPEG, and H.264
- Powerful Image Resolution Support
 - QCIF(176x144), CIF(352x288), QVGA(320x240), and VGA(640x480)
- Up to 30fps at 1Mbps with VGA-Resolution(MPEG-4)
- Video Conference Call Support (AddPac MCU Inter-working)
- SIP, H.323 Signaling Support
- Rate Control for Video Traffic QoS
 - Ensuring Optimized Quality
 - Frame Rate with Limited Bandwidth
- High-end Error Resilient Against Various Packet Error



AP-IP300 Premium IP Phone

IPNext 600 Next Generation IP-PBX System

- LCD Window : 4.3 Inch High Quality Color LCD
- External I/O Interface
 - Audio In/Out
 - Two(2) Fast Ethernet Interface
 - PSTN FXO Interface (option)
 - USB 1.1 Host Mode Interface
- 25 Speed Dial Key and Presence Indication LAMP
- Various Voice Codec Support
 - G.711, G.726, G.729, G.723.1, etc
- SIP, H.323 Signaling Support
- Traffic Control, IP Share
- IP Audio Broadcasting Support



AP-IP150 IP Phone

IPNext 600 Next Generation IP-PBX System

- LCD Display
- External I/O Interface
 - Audio In/Out
 - Two(2) Fast Ethernet Interface
 - RS-232C Console(RJ45)
 - PSTN FXO Interface (optional)
- PoE (Power over Ethernet) Support
- Various Voice Codec Support
 - G.711, G.726,G.729,G.723.1 etc
- SIP, H.323 Signaling Support
- Traffic Control, IP Share
- IP Audio Broadcasting Support



AP-IP120 IP Phone

IPNext 600 Next Generation IP-PBX System

- RISC+DSP Microprocessor Computing Power (Dual Processor Architecture)
- Optional PSTN Backup (FXO) Interface
- Optional PoE (Power over Ethernet)
- High quality Audio and Voice Interface
 - Stereo Audio Input Connector
 - Stereo Audio Output Connector
- Network Interface
 - Two(2) 10/100Mbps Fast Ethernet
- LCD Window : Graphic LCD (4 Line Text)
- 12 Speed-Dial Key with Presence Indication LAMP
- Power Supply
 - External Power Adaptor (5V, 2A)



AP-IP90 IP Phone

IPNext 600 Next Generation IP-PBX System

- LCD Window : Graphic LCD (4 Line Text)
- External I/O Interface
 - Audio In/Out
 - Two(2) Fast Ethernet Interface
 - PSTN FXO Interface (optional, AP-IP90E Model)
- Various Voice Codec Support
 - G.711, G.726, G.729, G.723.1, etc
- SIP, H.323 Signaling Support
- Traffic Control, IP Share
- IP Audio Broadcasting Support



AP-PT100 Presence Terminal

IPNext 600 Next Generation IP-PBX System

- User Presence and Touch Screen based Speed Dialing Terminal
- “7 Inch Color TFT LCD with Touch Screen
- Inter-working with IP Terminal, Presence Server, Call Manager
- Multiple Terminal Cascading Feature
- User Presence Group Feature
- Firmware Upgradeable Architecture
- PoE (Power over Ethernet) Function
- Internal Speaker



Smart Messenger for UC

IPNext 600 Next Generation IP-PBX System

- **Smart Messenger Program**
 - PC based MS-Window Program
 - Support Messenger Service
 - Support Various Address Book
 - Support User Presence Information (Busy, Away, On-line, etc)
 - Support User Search Feature
 - Interoperation with Address Book and Smart Phone
 - Support Smart Phone Control and Setup
 - Call Control and Forward Setup
 - Support Unified Message Box
 - Voice Mail Box
 - Short Message Box



Smart Messenger

Standard IP-PBX System Application

IPNext 600 Next Generation IP-PBX System

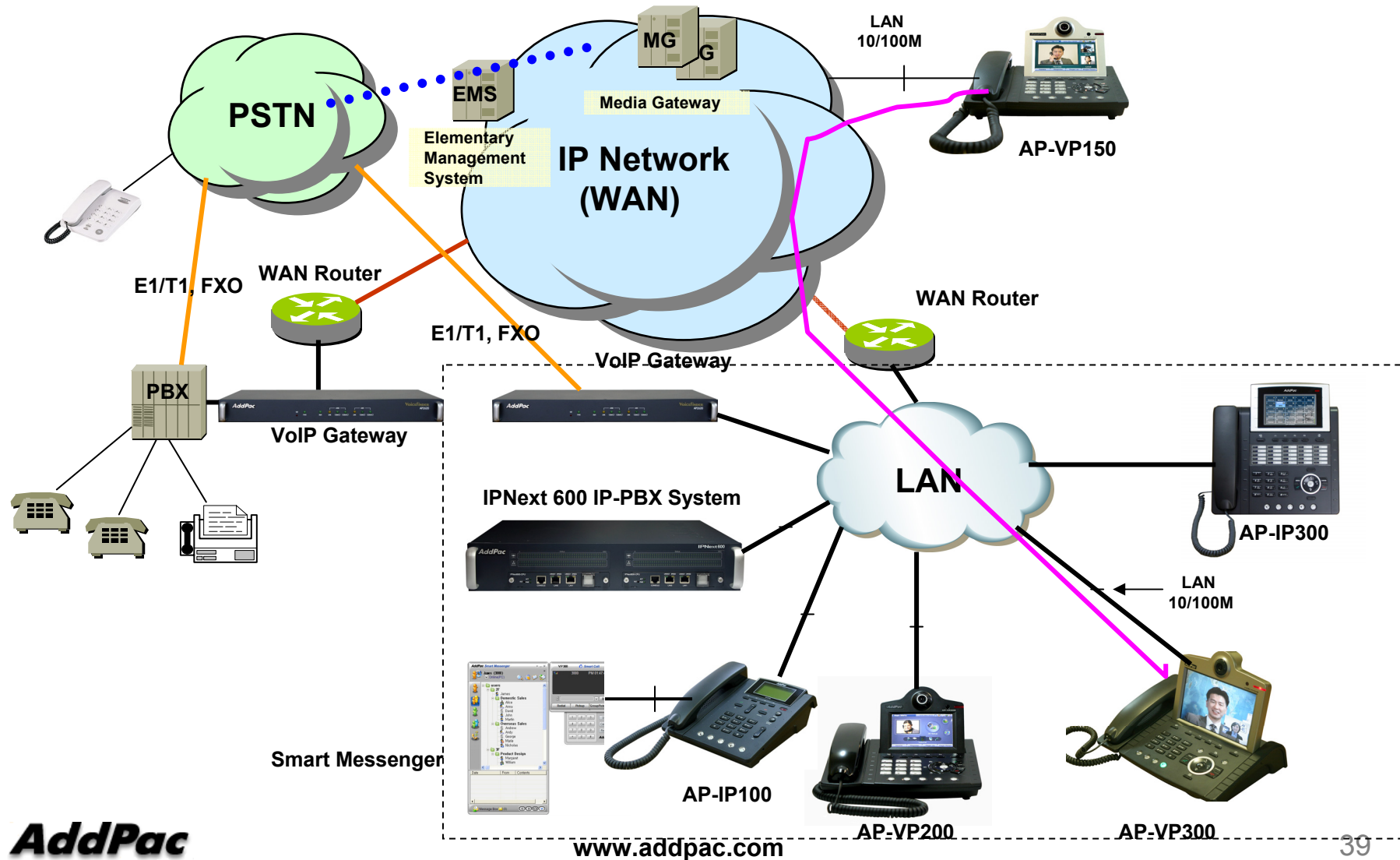

Ordering Information

- **IPNext 600 Next Generation IP-PBX Hardware**
 - IPNext 600 IP-PBX Main Body
 - High-performance 64bit RISC CPU
 - High-End 64bit CPU board (Hot-Swap)
 - 2-ports Fast Ethernet and 1-port RS-232C Console
 - Including Network Cable Set & Ext. Power Supply, etc.
 - Power Supply Module (Hot-Swap)
 - Additional CPU board for Fault Tolerant (option)
 - Additional Power Supply Module for Redundancy (option)
- **Built-in APOS Internetworking Software for IPNext 600**
- **Including 1 Year Hardware Warranty**
- **Product Documents**
 - Install and Operation Guide (PDF)
- **Pricing**
 - AddPac Technology Regional Sales Manager
 - Authorized Sales and Marketing Representatives
 - Please Contact www.addpac.com



Thank you!

AddPac Technology Co., Ltd.
Sales and Marketing

Phone +82.2.568.3848 (KOREA)

FAX +82.2.568.3847 (KOREA)

E-mail sales@addpac.com