

AP-NR1500 IP 음성 녹취 서버

아날로그 회선 녹취 솔루션



AddPac

AddPac Technology

Sales and Marketing

www.addpac.com

목차

- 네트워크 구성도
- 아날로그 회선 녹취 솔루션
 - AP2650 32포트 아날로그 VOIP 게이트웨이 (음성녹취서비스)
 - AP-NR1500 IP 음성 녹취 서버
 - AP1800 디지털 E1 VoIP 게이트웨이

네트워크 구성도

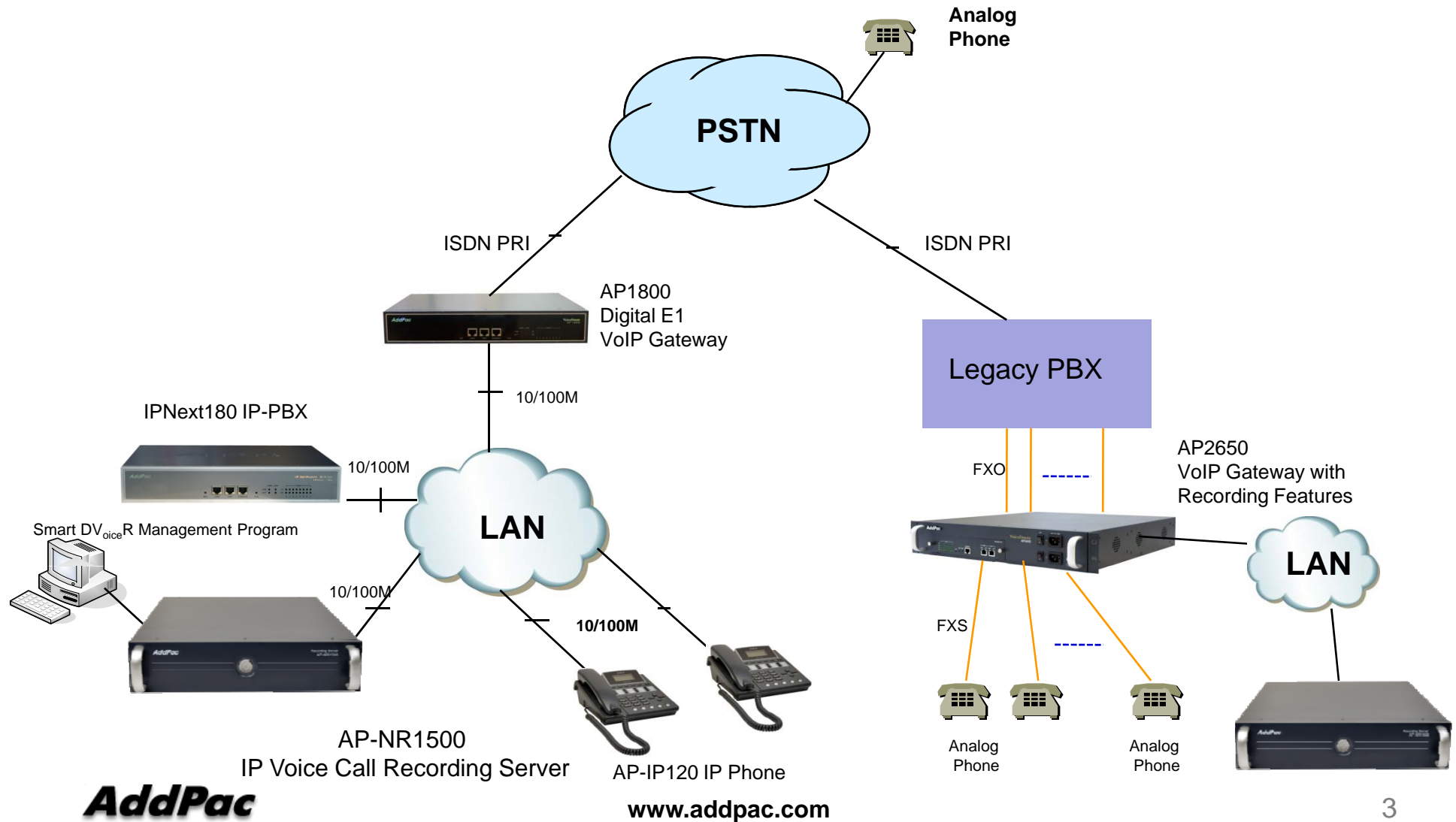



AP2650

VoIP 게이트웨이 (IP 음성 녹취 지원)

제품 주요 특징

- Voice Recording Interface Support
- Module Type Hardware
- Various VoIP Codec Support : G.711, G.729A, etc
- FXS, FXO, E&M, Digital E1/T1 VoIP Interface
- Up to 32 Port Analog Interface
- IPv4/IPv6 Address Support
- SIP, H.323 VoIP Signaling Support
- Real-time Operating System
- Powerful Network Protocol
- Firmware Upgradeable Architecture
- Dual Power Supply for Redundancy



하드웨어 사양

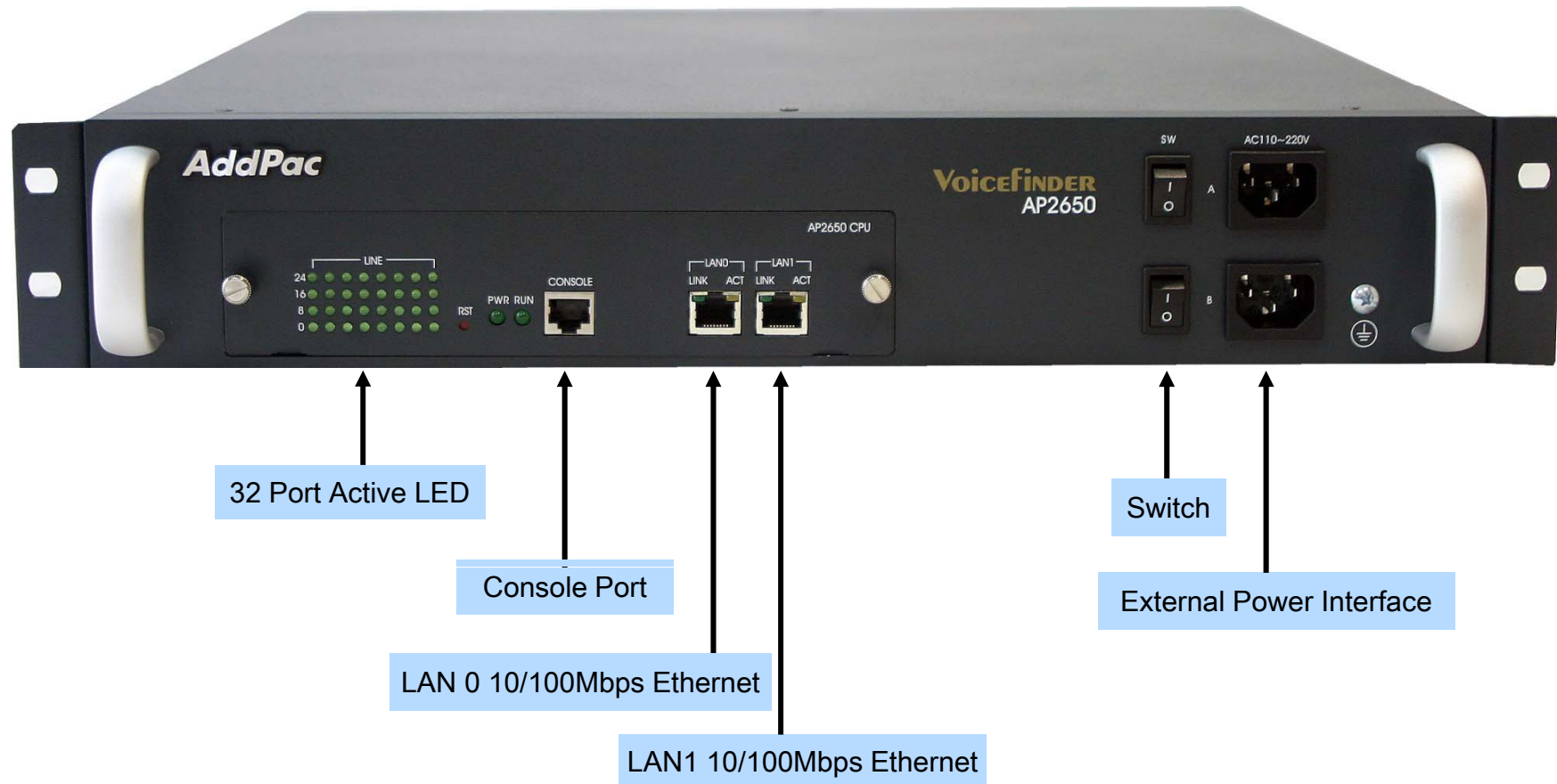

하드웨어 사양

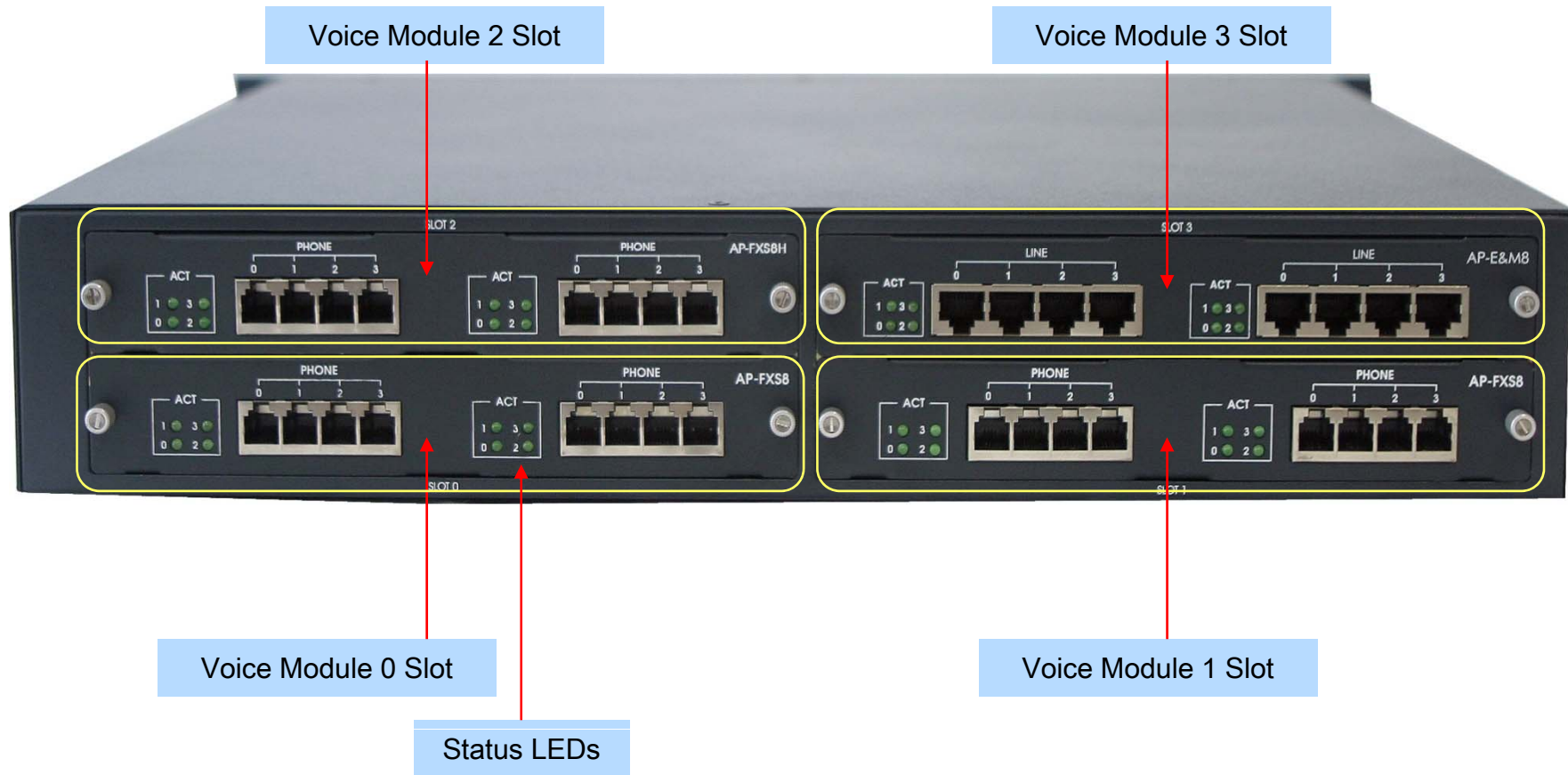

하드웨어 사양



AP-FXS8 Module



AP-FXO8 Module

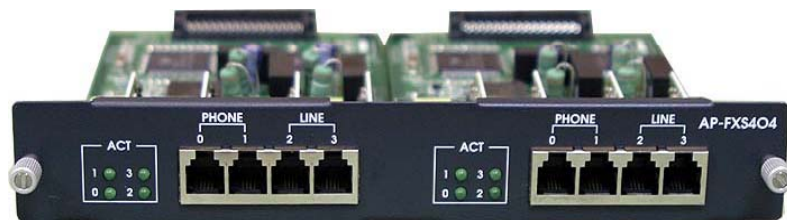

AP-FXS4O4 Module



AP-E&M8 Module

AP1800

디지털 E1 VoIP 게이트웨이



제품 주요 특징

- H.323/SIP Concurrent Stack Embedded
- High Performance RISC & Programmable DSP Architecture
- Analog/Digital VoIP Gateway Solution
- Various Analog Interface Support : FXS, FXO, E&M
- Two(2) 10/100Mbps Fast Ethernet (IP Share ,etc)
- High Performance LAN-to-LAN Routing Capability
- G.711/G.726/G.723/G.729, T.38 Fax , VAD, etc
- Powerful Network Protocols (PPPoE, DHCP, Static Routing, etc)
- Firmware Upgradeable Architecture
- VPMS (VoIP Plug&Play Management System) for Large Scale Deployment
- Advanced Voice QoS Mechanism
- Light and Compact Design with Internal Power Supply
- Two(2) VoIP Module Slot
- Hot-Swap Function Support

RISC
CPU

High-end
DSP

- **RISC Microprocessor Computing Power**
- **Up to 16 Port Analog VoIP Gateway**
- **Two(2) VoIP Module Slots (Hot-Swap)**
 - 8-Port FXS Card, 8-Port FXO Card, 4-Port FXS 4-Port FXO Card , Digital E1/T1 Card
- **Network Interface**
 - Two(2) 10/100Mbps Fast Ethernet (RJ45)
- **RS232C Console Interface**
- **Run LED, LAN LED, Port LEDs**
- **Internal Power Supply**

하드웨어 사양

Hardware Specifications

AP1800 VoIP Series	Basic Specifications
Voice Interface	Two(2) VoIP Module Slots AP-N1-FXS8, AP-N1-FXO8, AP-N1-FXS4O4, AP-N1-E1
Ethernet Interface	2-Ports 10/100Mbps Ethernet Interface(RJ-45)
Flash Memory	4Mbyte High-speed Flash Memory
Base Memory	32 Mbyte High-speed SDRAM
Power Requirement	Power Supply Adaptor / VAC 110~220V, 50/60Hz,
Operating Temperature	0°C ~ 45°C (32 °F ~ 122°F)
Storage Temperature	-40°C ~ 85°C (-40°C ~ 185°F)
Relative Humidity	5% ~ 95% (Non-condensing)

Network interface Configurations

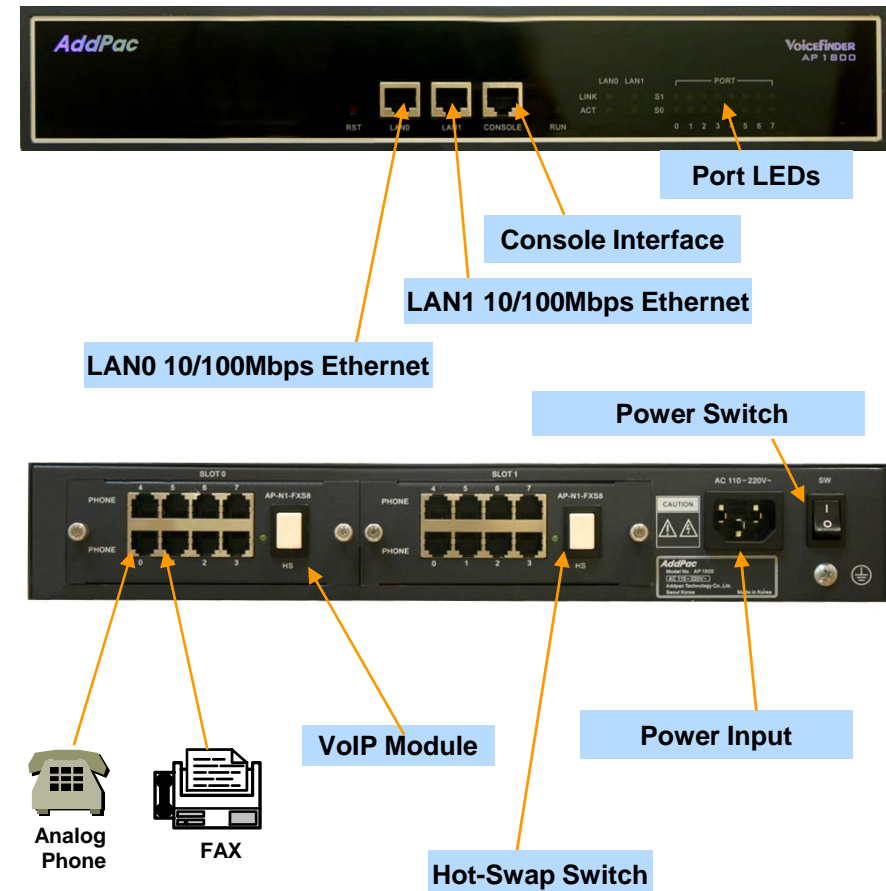

하드웨어 사양

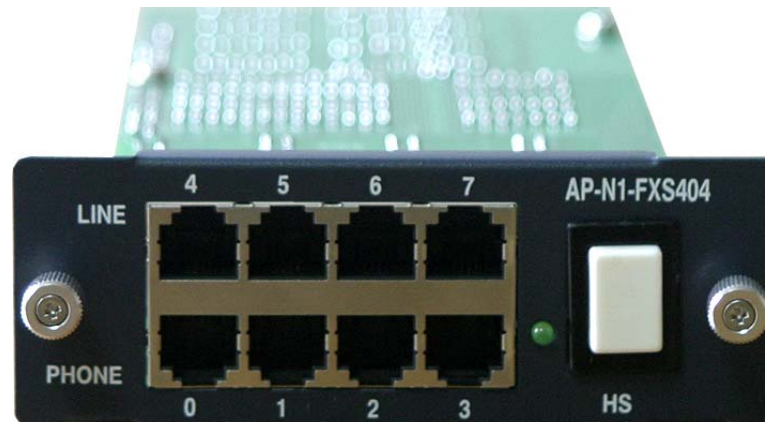

**AP-N1-FXS404
(4-Port FXS-
4-Port FXO Module)**



**AP-N1-E1
(Digital E1 Module)**



AP-NR1500

IP 음성 녹취서버

제품 주요 특징

- IP based Network Voice Call Recording Server
- Linux Operating System
- Powerful Management and User Friendly Features
- High-performance Voice Recording Service
- External AddPac IP Terminal (Ex: IP Phone, IP Intercom, IP Emergency Phone) Interworking Support
- Firmware Upgradeable Architecture
- One(1) 10/100/1000Mbps Gigabit Ethernet Interface
- Up to Two(2) 3.5Inch SATA Hard Disk Interface Support
- Two(2) USB Interface Support
- One(1) RS232C Console Interface

하드웨어 사양

- High Performance Computing Power
- Network Interface
 - One(1) 10/100/1000Mbps Gigabit Ethernet Port
- Two(2) USB 2.0 Interfaces for Mouse, Secondary Storage, etc
- One(1) RS232C Console Interface (RJ45)
- Up Two(2) SATA type Hard Disk (4~8 Tera HDD Capacity)
- Power On/Off Soft Switch with LED Indication Lamp (Front Side)

하드웨어 사양

AP-NR1500 Front Side



Power On/Off Switch with LED Indication LAMP

하드웨어 사양

AP-NR1500 Back Side

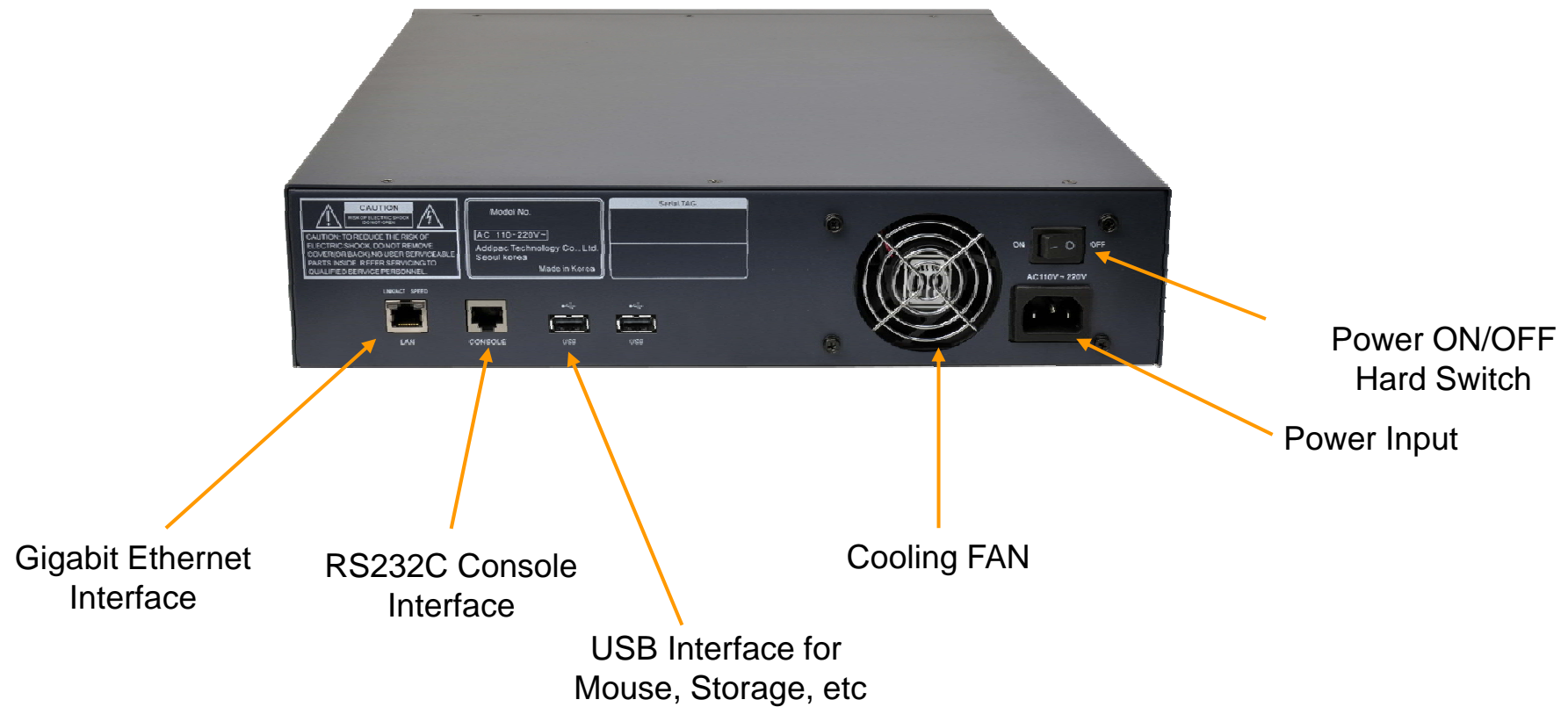

소프트웨어 사양

- **Built-in AddPac Internetworking Software**
 - Scalability, Functionality, and Stability Features
 - Advanced Network DV_{oice}R Recording & Live Streaming Features
 - QoS Control Features
- **Firmware Upgradeable Architecture**
- **Industry Standard Network Protocol Features**
- **Highly User Friendly Management Features**
 - PC based Window Program
 - Smart DV_{oice}R Manager

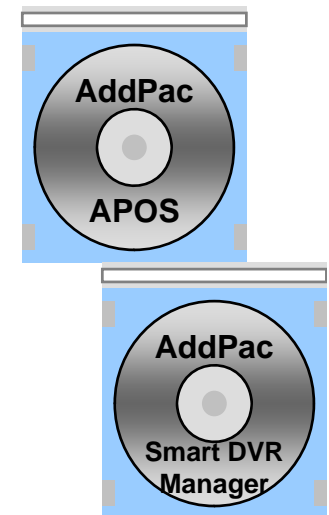

스마트 녹취관리 프로그램 주요특징

- Call History Management (search/modify/delete/save)
- Media Play Management (Play/Stop/Seek/Pause)
- Live Call List Management, Live Call Monitoring
- Local Backup (File Manager Support, PC HDD, DVD) and Local Play
- User Management (registration/modify/delete/search)
- Server Status (CPU/Memory/HDD) & Event Monitoring
- Waveform Analyzing Function
- Recording Source Management (VoIP Gateway, IP Phone, etc)
- Live Recording Board

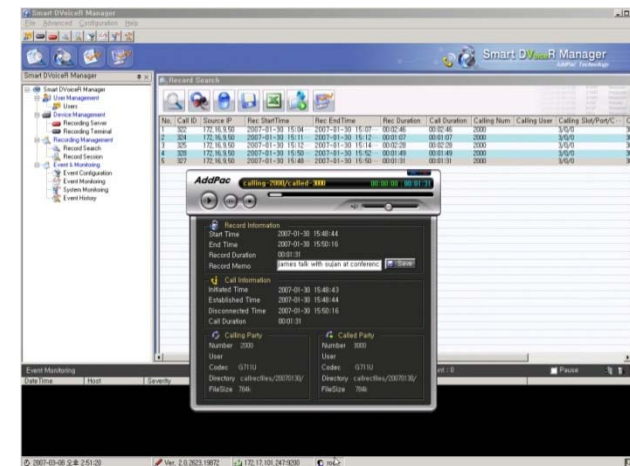

응용 분야

- Call Center Application
- Enterprise Application
- All IP Network Application

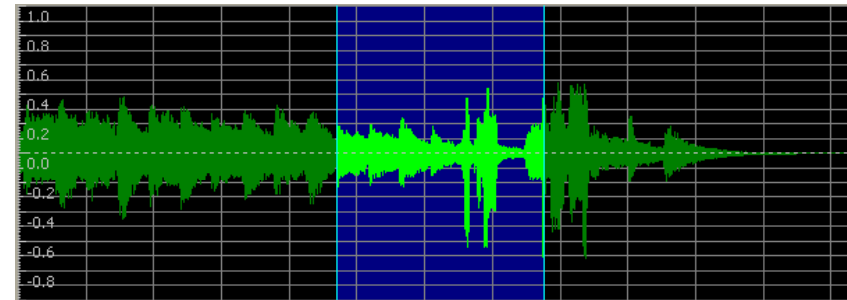



Thank you!

AddPac Technology Co., Ltd.
Sales and Marketing

Phone +82.2.568.3848 (KOREA)

FAX +82.2.568.3847 (KOREA)

E-mail sales@addpac.com