

Local Government CCTV Solution



AddPac

AddPac Technology

2010, Sales and Marketing

www.addpac.com



Local Government CCTV Solution Component(D1)

Contents

- AddPac Network DVR Service Diagram
- AddPac Network DVR Solution Components
 - Analog Speed Dome Camera for Outdoor App.
 - Video Codecs (H.264, RTSP)
 - Subtitle Generator (NTSC, PAL)
 - Digital AMP for External Speaker
 - Video Splitter
 - Video Signal Converter(NSTC/PAL, RGB, DVI, HDMI)
 - Live Video Displayers
 - IP Emergency Call Solution for NDVR
 - Audio Broadcasting Solution for Emergency
 - NDVR Streaming Server
 - NDVR Storage Server
 - NDVR Management Server
 - NMS (Network Management System) for NDVR Systems

Network DVR Service Diagram

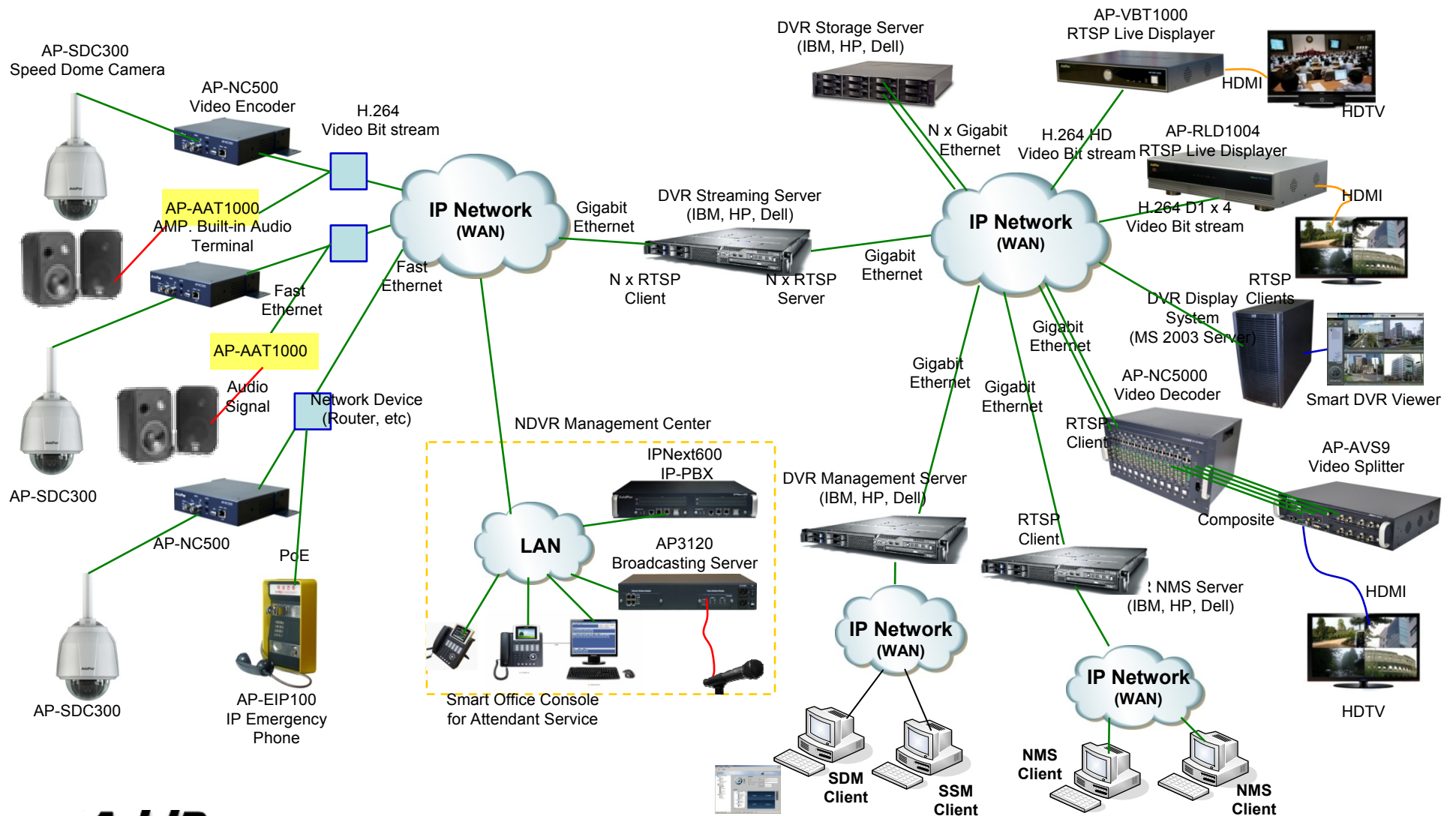



Analog Speed Dome Camera for Outdoor Application

Analog Speed Dome Camera

AP-SDC300 Speed Dome Camera

Main Features

- High-End Speed Dome Video Camera Features
- ¼ inch, Double Density Interline Transfer SONY CCD Image Sensor
- D1 (720x480)/30frame Video Resolution Support
- Speed PAN/TILT/Zoom Features
- Optional Housing Features for Outdoor Application
- Optical 37x Zoom, Digital 12 x Zoom Camera
- DNR (Digital Noise Reduction) Feature Support
- Day & Night (ICR) Feature Support
- Motion Detection Support
- NSTC : AP-SDC300N, PAL : AP-SDC300P

Analog Speed Dome Camera

AP-SDC300 Speed Dome Camera

Camera Module Specifications



CCD	1/4" , Double Density Interline Transfer CCD Image Sensor
	Effective Pixels(NSTC) : 768(H) x 494(V) Effective Pixels (PAL): 752(H) x 582(V)
Pixel	410,000 Pixel
Optics	37x, f=3.5 to 129.5.0mm(F 1.6 to 3.9) 12x Digital Zoom (On/Off)
Scanning System	2:1 Interlace
Frequency	NTSC : 15.734KHz(H) / 59.94Hz (V) PAL : 15.625KHz(H) / 50.00Hz (V)
Resolution	550 TV Lines(Min.) : Color, 680TV Lines(Min.) : B/W
Min. illumination	Color : 0.7 Lux/F1.6 (50 IRE) B/W : 0.03 Lux/F1.6 (50 IRE), 0.03 Lux/256 = 0.0001171 Lux 256 is Shutter Speed.
S/N (Y Signal)	50dB
Focus	Auto/Manual/One-Push
Zoom Speed	2.5 Sec(Fast)/3.1Sec(Middle)/5.6Sec(Slow)
IRIS Control	Auto/Manual
Day & Night	Auto /Color/BW/Ext
White Balance	ATW/AWC/MANUAL/INDOOR/OUTDOOR
Backlight	WDR/BLC/HLC/OFF
Motion Detection	ON/OFF (Output via communication)
Preset	128 Positions
Electronic Shutter Speed	Auto/Manual/A.FLK X256 ~ 1/120,000

AddPac

www.addpac.com

Analog Speed Dome Camera

AP-SDC300 Speed Dome Camera

Hardware Specification



37x Optical Zoom Camera
Module

AddPac

www.addpac.com



Video Codecs

Video Codec

AP-NC500 Video Codec

Main Features

- IP based Audio/Video Encoding/Decoding Solution
- Various Video Codec Support : H.264, MPEG4
- Up to D1 Video Resolution
- RTSP, TCP/UDP Protocol Support
- IP based Network Surveillance Solution
- High-performance Video, Audio, and Voice Service
- Firmware Upgradeable Architecture
- Video Solution with Outstanding Network Service Capability
- Audio/Video Privacy Protection
- External DC Power Supply Adaptor
- Compact Chassis

Video Codec

AP-NC500 Video Codec

Hardware Specification

AP-NC500 Front View



Video In/Out Port



Power On/Off Switch

www.addpac.com

DC Power Supply

RS-232C, RS422 Interface

2 Alarm Input, 1 Relay Out

AddPac

Video Codec

AP-NC1200 Video Codec

Main Features

- IP based Audio/Video Encoding/Decoding Solution
- Various Video Codec Support : H.264
- One(1) Module 2-Card Slot for Video/Audio Codec Modules
- Up to D1 Video Resolution
- RTSP, TCP/UDP Protocol Support
- IP based Network Surveillance Solution
- High-performance Video, Audio, and Voice Service
- Firmware Upgradeable Architecture
- Video Solution with Outstanding Network Service Capability
- Audio/Video Privacy Protection
- External DC Power Supply Adaptor
- Compact Chassis

Video Codec

AP-NC1200 Video Codec

High-end
DSP

AP-NC1200 Video Codec Modules

AV1500N D1 Video Encoder Module
(H.264 D1, CIF Dual Encoding)



AP-NC1200 Audio Codec Modules

AA1000N AMP built-in Audio Broadcasting
Module (G.711, G.726, etc)

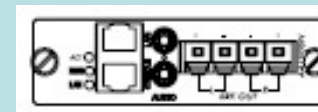

Video Codec

AP-NC1200 Video Codec

High-end
DSP

AP-NC1200 Subtitle Generator Modules

AS1000N Analog Subtitle Generator Module



Video Codec

AP-NC1200 Video Codec

Hardware Specification

AP-NC1200 Front Side View



Video Codec

AP-NC1200 Video Codec

Hardware Specification

Two(2) AP-AV1500N Dual Channel D1 Video Encoder Module

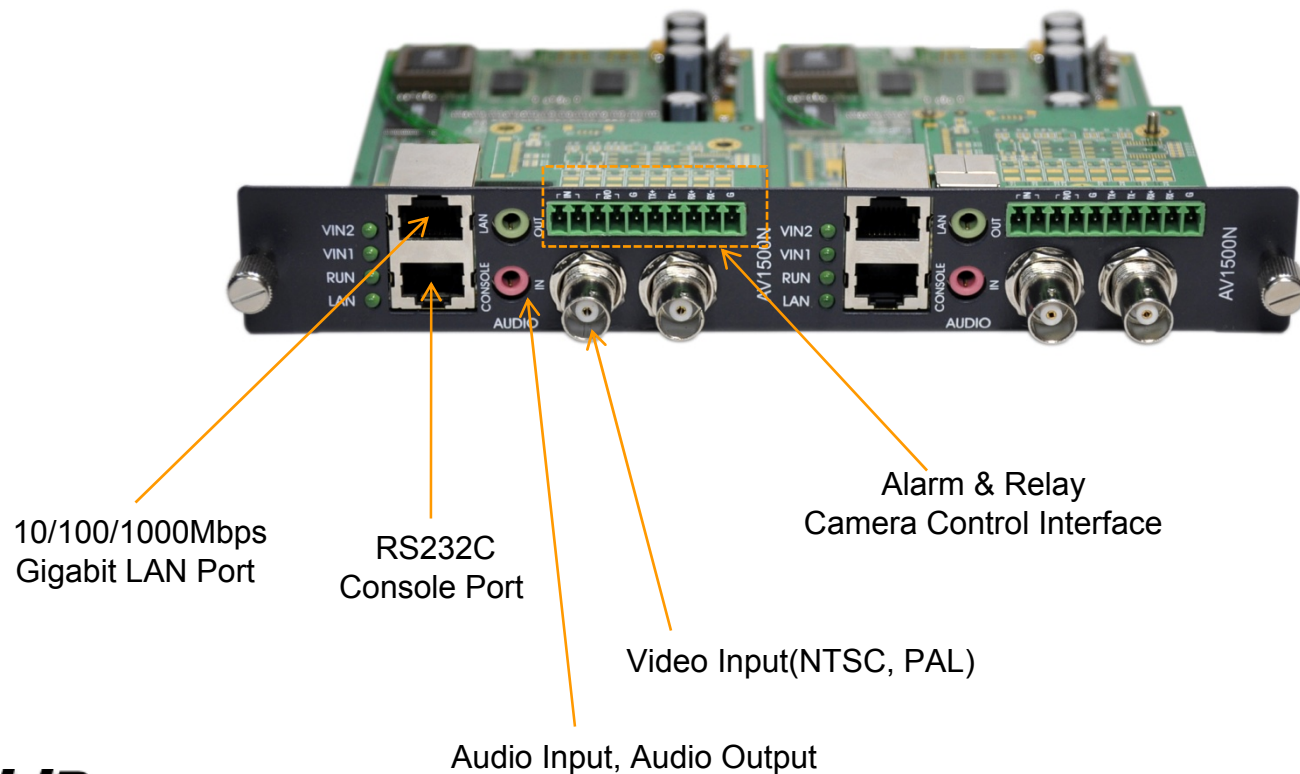

10/100/1000Mbps
Gigabit LAN Port

RS232C
Console Port

Alarm & Relay
Camera Control Interface

Video Input(NTSC, PAL)

Audio Input, Audio Output

www.addpac.com

Video Codec

AP-NC1500 Video Codec

Main Features

- IP based Audio/Video Encoding/Decoding Solution
- Various Video Codec Support : H.264
- Two(2) Module 4-Card Slot for Video/Audio Codec Modules
- Up to D1 Video Resolution
- RTSP, TCP/UDP Protocol Support
- IP based Network Surveillance Solution
- High-performance Video, Audio, and Voice Service
- Firmware Upgradeable Architecture
- Video Solution with Outstanding Network Service Capability
- Audio/Video Privacy Protection
- Internal Power Module
- Compact Chassis

Video Codec

AP-NC1500 Video Codec

High-end
DSP

AP-NC1500 Video Codec Modules

AV1500N D1 Video Encoder Module
(H.264 D1, CIF Dual Encoding)

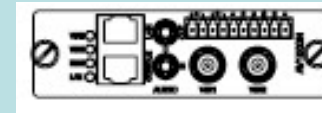

AP-NC1500 Audio Codec Modules

AA1000N AMP built-in Audio Broadcasting
Module
(G.711, G.726, etc)

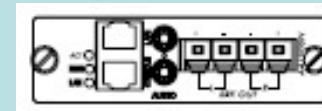

Video Codec

AP-NC1500 Video Codec

High-end
DSP

AP-NC1500 Subtitle Generator Modules

AS1000N Analog Subtitle Generator Module



Video Codec

AP-NC1500 Video Codec

Hardware Specification

AP-NC1500 Front Side View



AP-AV1500N Module
Dual Channel D1 Encoder Module

AP-AA1000N
AMP Built-in Audio Broadcasting
Module

AP-NC1500 Back Side View



Video Codec

AP-NC2000D Video Codec

Main Features

- IP based Audio/Video Encoding/Decoding Solution
- Single Slot for Video Modules
- Various Video Codec Modules Support
- H.264 Video Codec : D1 Module(D1, CIF Dual Encoding)
- RTSP, TCP/UDP Protocol Support
- IP based Network Surveillance Solution
- High-performance Video, Audio, and Voice Service
- Firmware Upgradeable Architecture
- Video Solution with Outstanding Network Service Capability
- Audio/Video Privacy Protection
- External DC Power Supply Adaptor
- Compact Chassis

Video Codec

AP-NC2000D Video Codec

Hardware Specification

AP-NC2000D Front View



AV2000 D1 Video Module



Power On/Off Switch

DC Power Supply

Video Codec

AP-NC2000D Video Codec

High-end
DSP

AP-NC2000D Video Codec Modules

AV5000E HD Video Encoder Module
(H.264 720P, D1 Dual Encoding)



AV5000D HD Video Decoder Module



AV3000 HD Video Encoder/Decoder Module
(H.264 720P, D1 Dual Encoding)



AV2000 D1 Video Encoder/Decoder Module
(H.264 D1, CIF Dual Encoding)



Video Codec

AP-NC2000D Video Codec

High-end
DSP

AP-NC2000D Video Codec Modules

AV1800 D1 Video Decoder Module
(H.264/MPEG4 D1 Decoding)



Video Codec

AP-NC2000D HD Video Codec

High-end
DSP

Hardware Module Specification

AV2000 D1 Video Encoder/Decoder Module (H.264)

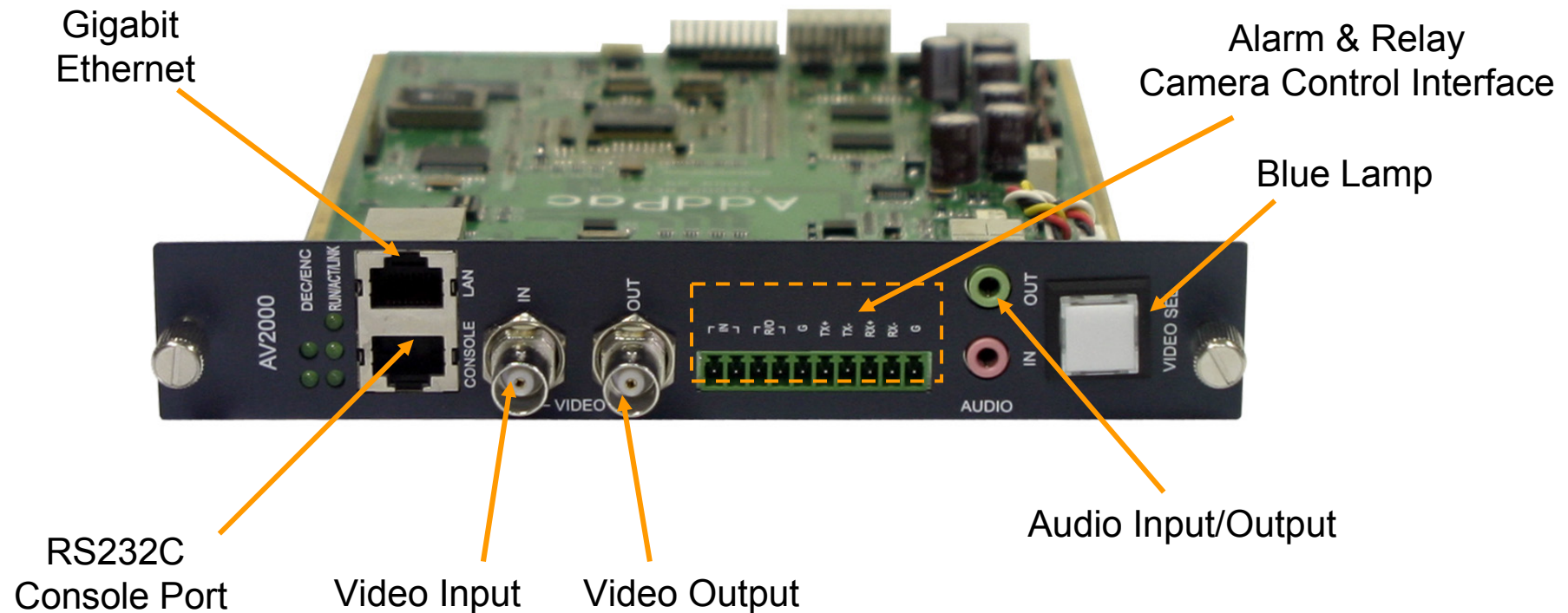

Video Codec

AP-NC2000D HD Video Codec

High-end
DSP

Hardware Module Specification

AV1800 Video Decoder Module
(H.264, MPEG4, Up to D1 Resolution)

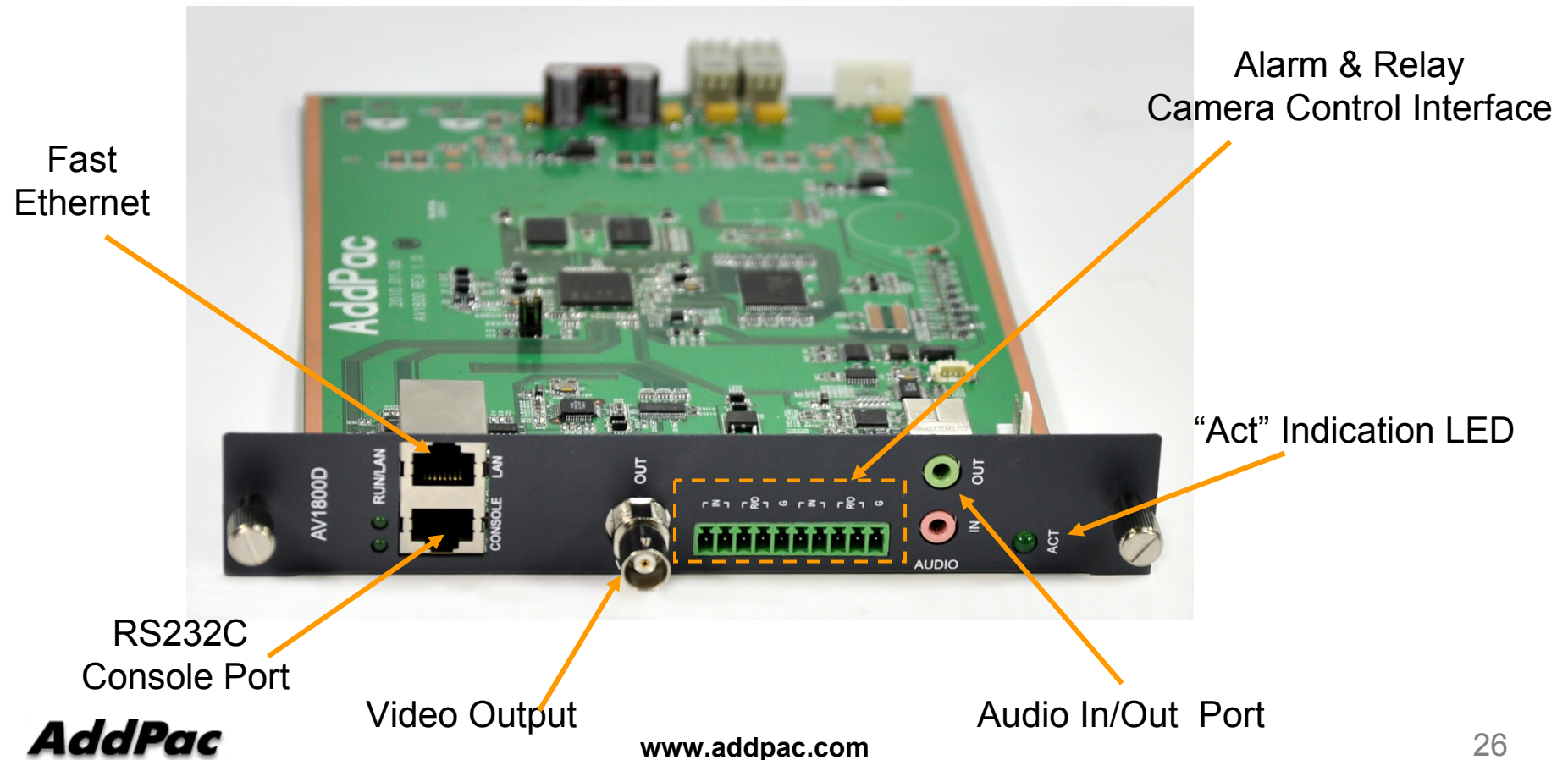

AddPac

www.addpac.com

Video Codec

AP-NC2000 Video Codec

Main Features

- IP based Audio/Video Encoding/Decoding Solution
- Single Slot for Video Modules
- Various Video Codec Modules Support
- H.264 Video Codec : D1 Module(D1, CIF Dual Encoding)
- RTSP, TCP/UDP Protocol Support
- IP based Network Surveillance Solution
- High-performance Video, Audio, and Voice Service
- Firmware Upgradeable Architecture
- Video Solution with Outstanding Network Service Capability
- Audio/Video Privacy Protection
- **Internal Power Supply**
- Compact Chassis

Video Codec

AP-NC2000 HD Video Codec

Hardware Specification



AV2000 D1 Video Module

AP-NC2000 Front View



Power On/Off Switch

AC Power Supply

Video Codec

AP-NC3000 Video Codec

Main Features

- IP based Audio/Video Encoding/Decoding Solution
- Two(2) Slot for Video Modules
- Various Video Codec Modules Support
- H.264 Video Codec : D1 Module (D1, CIF Dual Encoding)
- RTSP, TCP/UDP Protocol Support
- IP based Network Surveillance Solution
- High-performance Video, Audio, and Voice Service
- Firmware Upgradeable Architecture
- Video Solution with Outstanding Network Service Capability
- Audio/Video Privacy Protection
- Internal Power Supply
- 19 Inch Rack Mountable

Video Codec

AP-NC3000 Video Codec

Hardware Specification



AV2000 D1 Video Module

AS2000 Analog Subtitle Generator Module

AP-NC3000 Front View



AC Power Supply

Power On/Off Switch

Video Codec

AP-NC3000 Video Codec

AP-NC3000 Video Codec Modules

AV5000E HD Video Encoder Module
(H.264 720P, D1 Dual Encoding)



AV5000D HD Video Decoder Module



AV3000 HD Video Encoder/Decoder Module
(H.264 720P, D1 Dual Encoding)



AV2000 D1 Video Encoder/Decoder Module
(H.264 D1, CIF Dual Encoding)



HD Video Codec (HD-SDI)

AP-NC3000 HD Video Codec

AP-NC3000 Subtitle Generator Modules

HS3000 HD-SDI Subtitle Generator Module



AS2000 Analog Subtitle Generator Module



Video Codec

AP-NC5000 Video Codec

Main Features

- IP based Audio/Video Encoding/Decoding Solution
- Twelve(12) Slot for Video Modules
- Various Video Codec Modules Support
- H.264 Video Codec : D1 Module (D1, CIF Dual Encoding)
- RTSP, TCP/UDP Protocol Support
- IP based Network Surveillance Solution
- High-performance Video, Audio, and Voice Service
- Firmware Upgradeable Architecture
- Video Solution with Outstanding Network Service Capability
- Audio/Video Privacy Protection
- Module Type Power Supply

Video Codec

AP-NC5000 Video Codec

AP-NC5000 Video Codec Modules

AV5000D HD Video Decoder Module



AV3000 HD Video Encoder/Decoder Module
(H.264 720P, D1 Dual Encoding)



AV2000 D1 Video Encoder/Decoder Module
(H.264 D1, CIF Dual Encoding)



AV1800 D1 Video Decoder Module
(H.264/MPEG4 D1 Decoding)



Video Codec

AP-NC5000 Video Codec

Hardware Specification

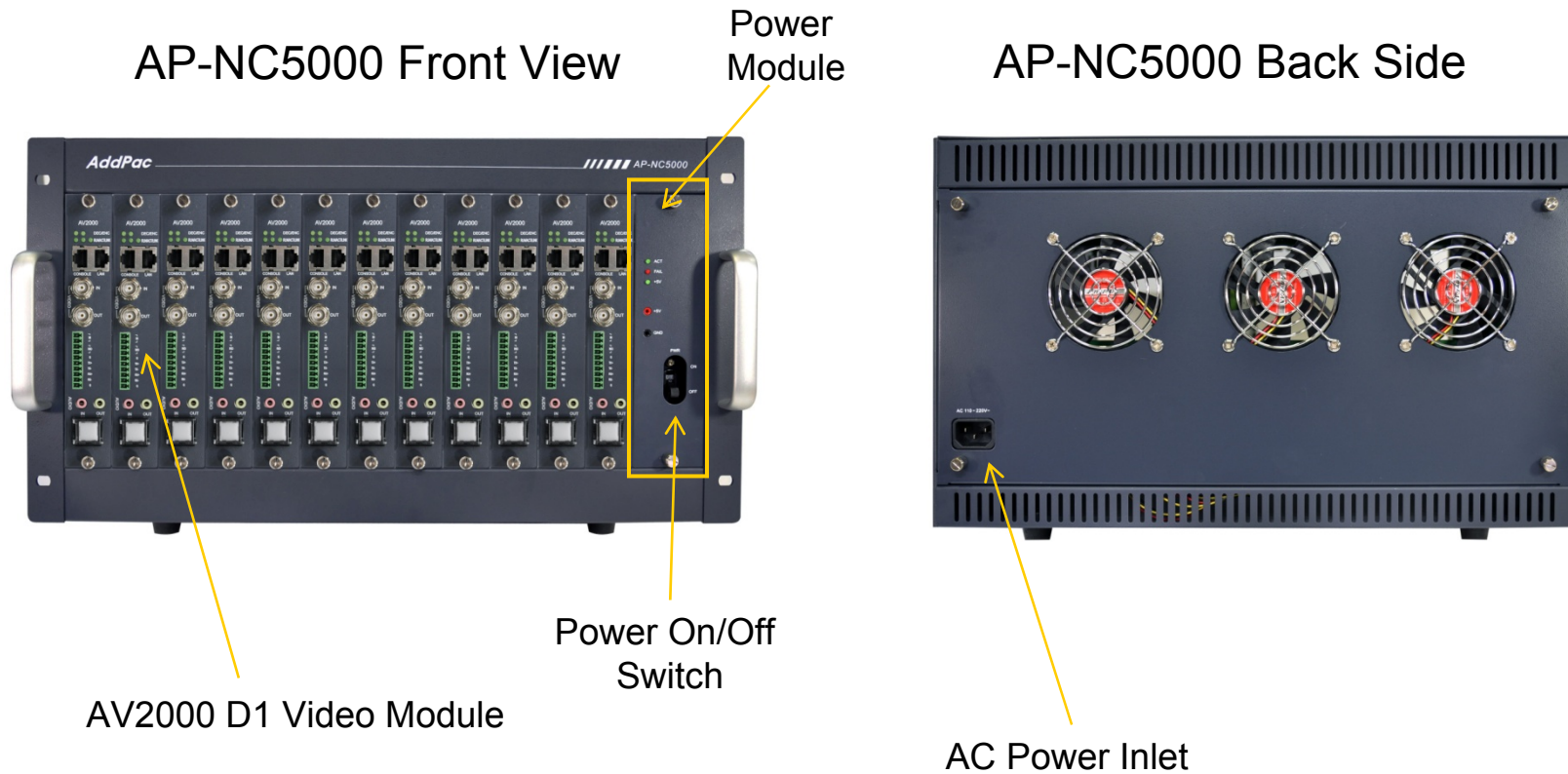

Video Codec

AP-NC5000 HD Video Codec

Hardware Specification

AP-NC5000 Front View



AV1800D Video Decoder Module (H.264/MPEG4, Up to D1)



Subtitle Generator

Subtitle Generator

AP-SG1000 Subtitle Generator

Main Features

- Subtitle Generation Service Features
- XML based Subtitle Controller Software (MS-Window)
- Single Slot for Subtitle Modules (HD-SDI, Analog)
- IP based Network Surveillance Solution
- High-performance Video, Audio, and Voice Service
- Firmware Upgradeable Architecture
- Video Solution with Outstanding Network Service Capability
- Audio/Video Privacy Protection
- Compact Chassis

Subtitle Generator

AP-SG1000 Subtitle Generator

Subtitle Generator Service Features

- Display Object at specific position(Character, Figure, Diagram, Bitmap)
- Character Object : Color, Font Size, Font, Boundary Color, Box, Box Color, Position, etc
- Character Scrolling Service
- Variable Subtitle Service by PTZ Position Information
- Erase Object within specific area
- Erase All Object
- Status Information Service (S/W Version, Flash Size, etc)
- Network Configuration

Subtitle Generator

AP-SG1000 Subtitle Generator

Subtitle Generator Service Features

- Subtitle Generation Management
 - Open, Save
 - Import, Export
- Subtitle Generation Edit
 - Polygon (ellipse, rectangle)
 - Line
 - Image
 - Text
- Subtitle Generation Option
 - Font (Font, Size, Style, Align, Color)
 - Style (BackColor, LineColor, Line style)
- Miscellaneous
 - Background image
 - Screen size
 - Zoom (+, -)
 - Undo, Redo, Copy, Paste, Cut

AddPac

www.addpac.com

Program Tool Area for SG Editing

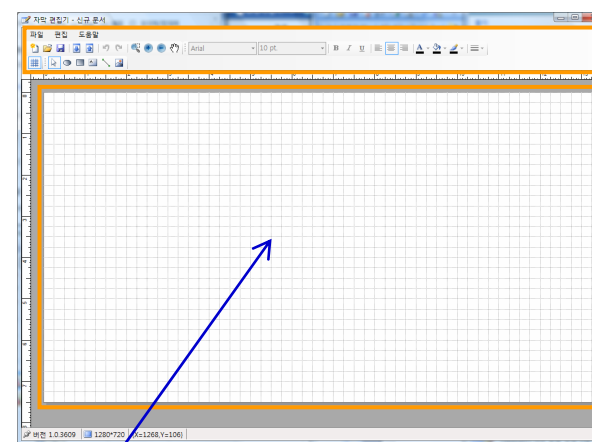
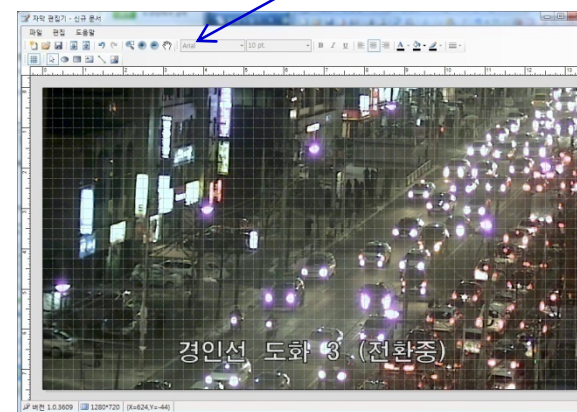

SG Editing Layout Area

Subtitle Generator

AP-SG1000 Subtitle Generator

Hardware Specification



AS2000 Analog Subtitle Generator Module

AP-SG1000 Front View



Power On/Off Switch

AC Power Supply

Subtitle Generator

AP-SG1000 Subtitle Generator

Hardware Specification

HS3000 HD-SDI Subtitle Generator Module



AS2000 Analog Subtitle Generator Module

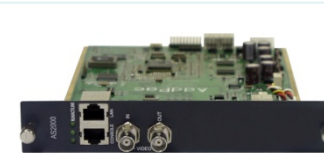

AS2000 Module (Analog)

AP-SG1000 Subtitle Generator

High-end
DSP

AS2000 Analog Subtitle Generation Module Specification

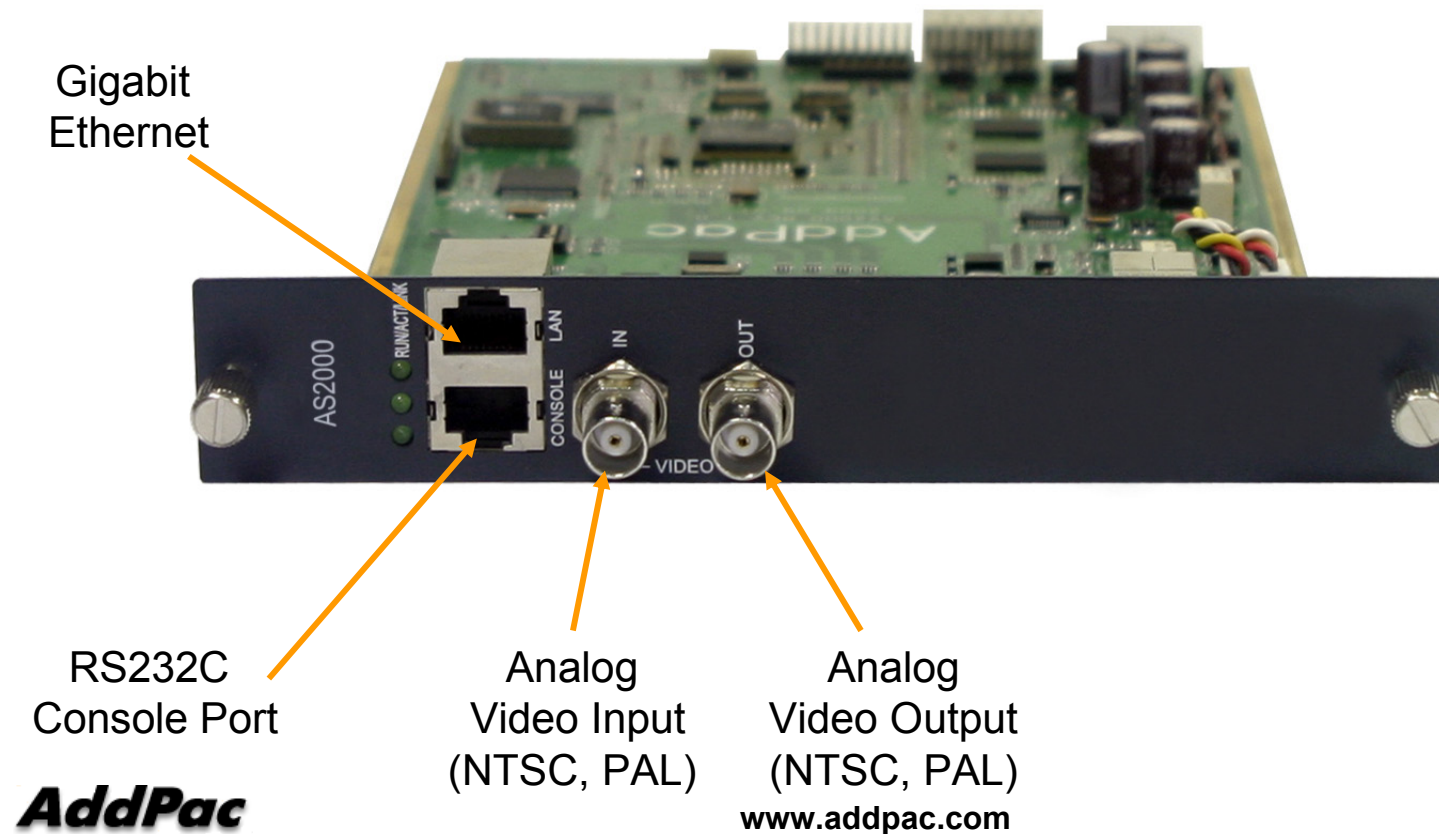

AddPac

www.addpac.com



Video Splitter

Analog Video Splitter

AP-AVS9 Video Splitter

Main Features

- Video Splitting Service Features
 - Various View Mode Layout (9ch, 4ch, 1ch, etc)
- Nine(9) Channel Analog Video Signal Input (NSTC, PAL)
- Analog Video Signal Loop-Out
- One(1) Channel HDMI Output for HDTV Display (Full HD, Upscaling)
- IP based Network Surveillance Solution
- High-performance Video, Audio, and Voice Service
- Web based Management
- Firmware Upgradeable Architecture
- Video Solution with Outstanding Network Service Capability
- Internal Power Supply Adaptor



Video Signal Converter

Video Signal Converter

AP-VSC1000 Video Signal Converter

Main Features

- Video Signal Converting Service Features
- Analog Video Signal Input or Output Port
- RGB 15 Pin VGA Signal Output Port
- HD-SDI Input Port
- HD-SDI Output Port
- One(1) Channel HDMI Output for HDTV Display (Full HD, Upscaling)
- IP based Network Surveillance Solution
- High-performance Video, Audio, and Voice Service
- Firmware Upgradeable Architecture
- Video Solution with Outstanding Network Service Capability
- Internal Power Supply Adaptor

Video Signal Converter

AP-VSC1000 Video Signal Converter

Video In/Out Signal Converting Matrix

Video Input	Video Output		
Analog Composite Video Input (BNC Connector, NSTC/PAL)	Upscaling	Upscaling	-
	HD-SDI Output (720P,1080i)	HDMI Output (720P, 1080i) 1024x768 for DVI Monitor	RGB Output (VGA)
HD-SDI Video Input (720P, 1080i)	Downscaling	Upscaling	Downscaling
	Analog Video Output (NTSC,PAL)	HDMI Output (720P, 1080i) 1024x768 for DVI Monitor	RGB Output (VGA)

Video Signal Converter

AP-VSC1000 Video Signal Converter

Hardware Specification

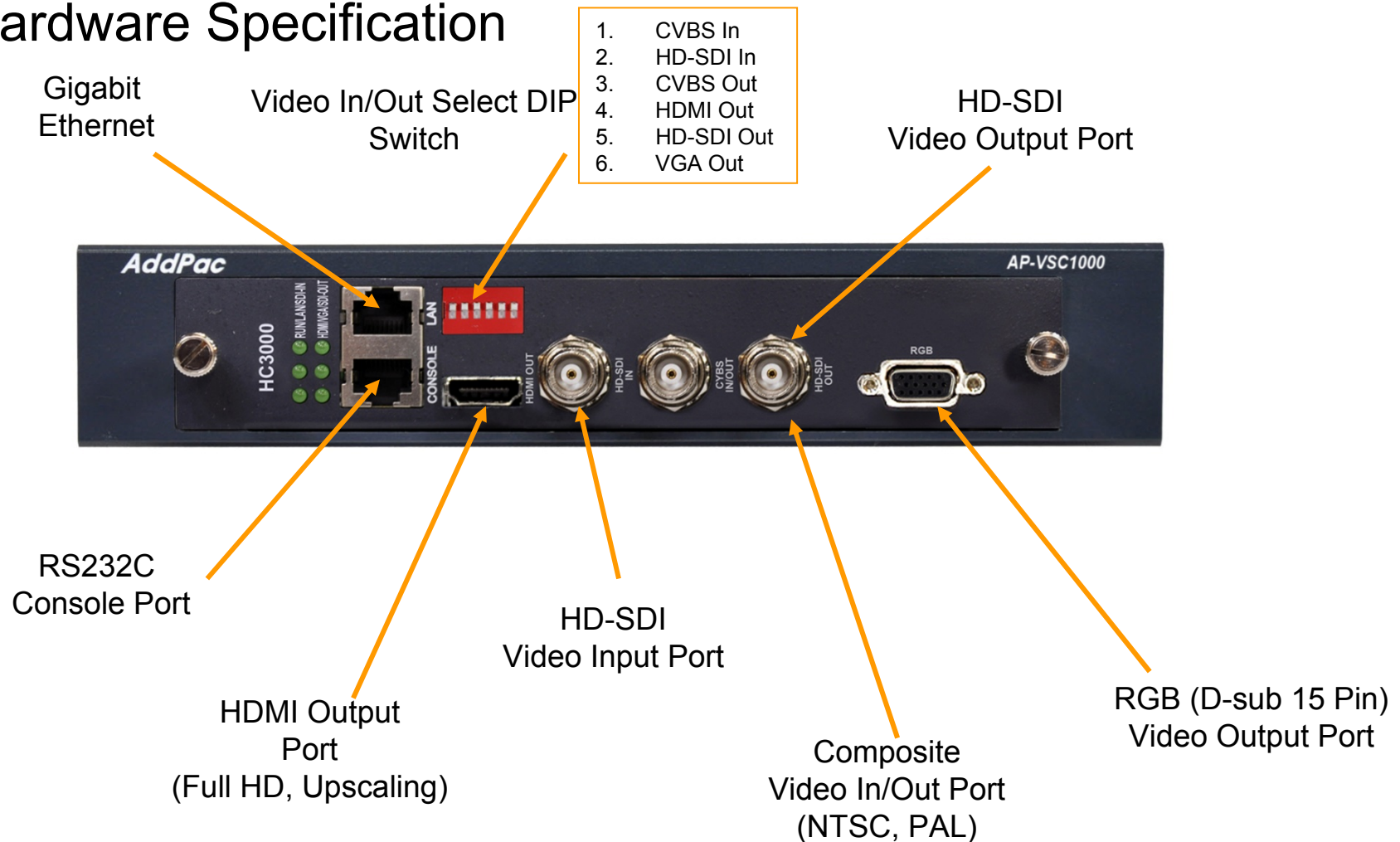



Live Video Displayers

RTSP based Video Displayers

Contents

- Network Diagram
- RTSP based Live Video Displayer
 - AP-VBT1000 Live Video Displayer
 - AP-RLD1004 Live Video Displayer

	AP-VBT1000	AP-RLD1004
Codec	H.264, MPEG4	H.264, MPEG4
Protocol	RTSP/RTP TCP/UDP	RTSP/RTP TCP/UDP
Performance	HD : 1Channel D1 : 1Channel	HD : 1 Channel D1 : 4/9 Channel
Display	HDMI, Full HD	HDMI, Full HD

RTSP based Video Displayers Network Diagram

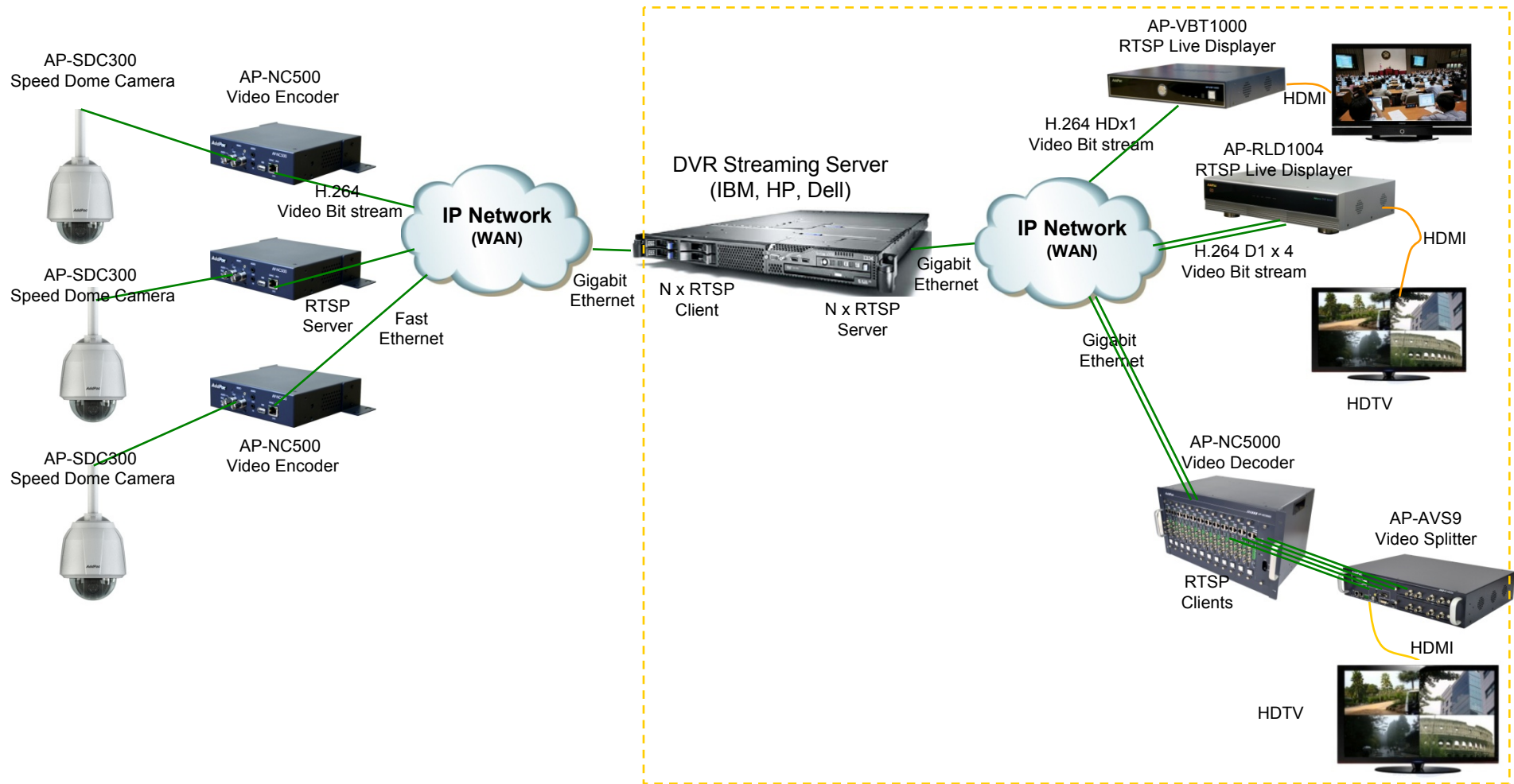

RTSP based Live Video Display

AP-VBT1000 Live Video Displayer

Main Features

- IP based Audio/Video Decoding Solution
- H.264, MPEG4 Single Channel Video Decoding
- RTSP based Network Surveillance Solution
- RTSP/RTP (TCP/UDP) Protocol Support
- H.264 BP/MP/HP HD(720P), D1 Video Resolution Support
- Full HD Live Display Support for HDTV Display via HDMI
- High-performance Video, Audio, and Voice Service
- Firmware Upgradeable Architecture
- Video Solution with Outstanding Network Service Capability
- Remote Controller Support
- Compact Chassis



RTSP based Live Video Displayer

AP-VBT1000 Live Video Displayer

High-end
Video
Processor

Hardware Specification

- High-End Audio/Video Processor
- Main Chassis
 - Power On/Off Switch (Front Panel)
 - Remote Controller Sensor (Front Panel)
 - On-AIR Indication LAMP (Front Panel)
 - Network Interface
 - Two(2) 10/100Mbps Fast Ethernet
 - Two(2) USB 2.0 Interface
 - One(1) RS-232C Console (RJ45)
 - IR-Out Interface for External TV Control
 - Powerful Video Interface
 - S-Video, Component Output, DVI Interface(HDMI)
 - High quality Audio and Voice Interface
 - Stereo Audio Output Connector
 - S/PDIF RCA Interface
 - S/PDIF Optical Interface

RTSP based Live Video Displayer

AP-VBT1000 Live Video Displayer

Hardware Specification

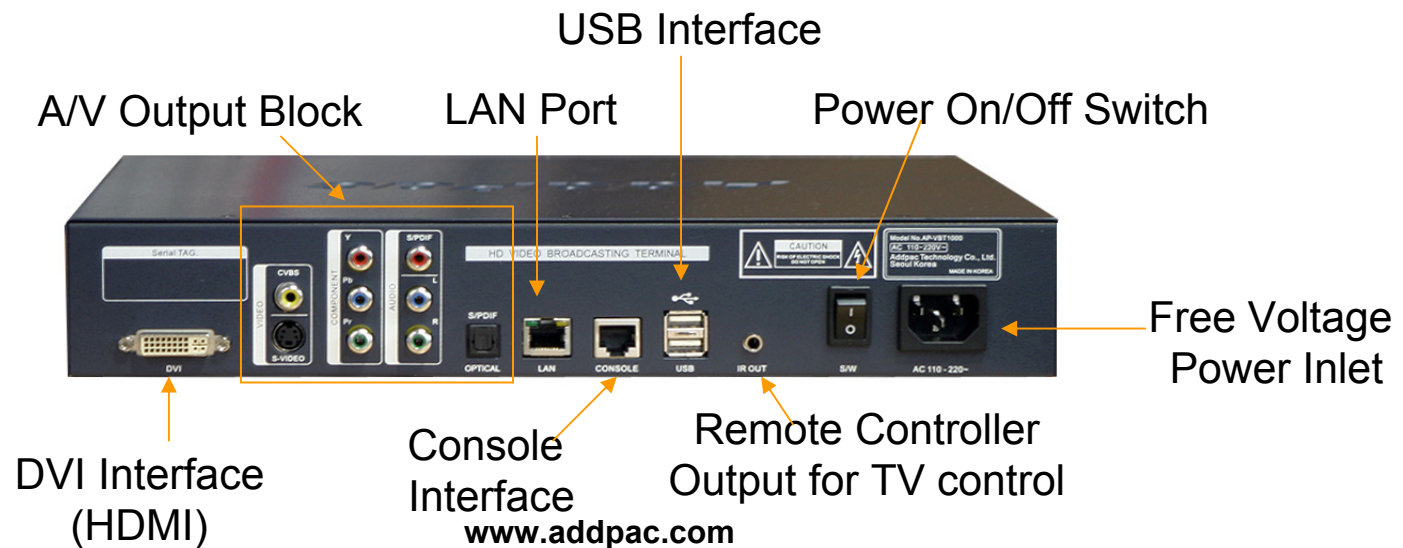
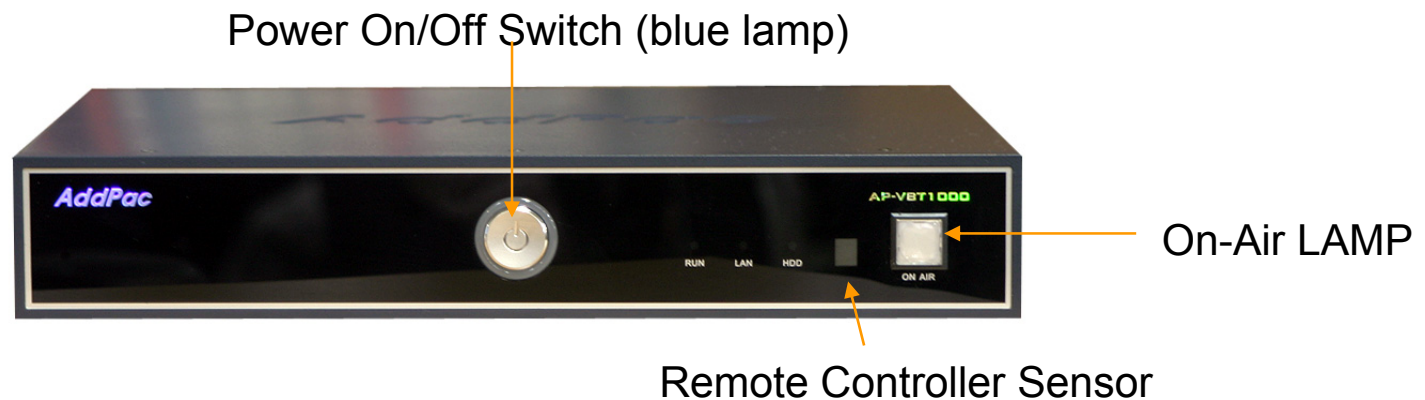

RTSP based Live Video Display

AP-RLD1004 Live Video Displayer

Main Features

- IP based Audio/Video Decoding Solution
- H.264, MPEG4 Video Decoding
- RTSP based Network Surveillance Solution
- RTSP/RTP (TCP/UDP) Protocol Support
- H.264 BP/MP/HP HD(720P), D1 Video Resolution Support
- Full HD Live Display Support for HDTV Display via HDMI
- HD : One(1) Channel, D1 : Up to Four(4) Channel Decoding
- High-performance Video, Audio, and Voice Service
- Firmware Upgradeable Architecture
- Video Solution with Outstanding Network Service Capability
- Remote Controller Support
- Compact Chassis



RTSP based Live Video Displayer

AP-RLD1004 Live Video Displayer

High-end
Video
Processor

Hardware Specification

- RISC Microprocessor + Video Processor Computing Power
- Main Chassis
 - Network Interface
 - One(1) 10/100/1000Mbps Gigabit Ethernet
 - Video Interface
 - Composite/S-video Video Output
 - DVI (HDMI) Video Output
 - Component Video Output for HDTV(720P)
 - Audio Interface
 - One(1) Audio 3.5mm Stereo Input Channel
 - Two(2) Audio RCA Output Channel (Left, Right)
 - Two(2) USB Host Mode Interface for Mouse (Front, Back), etc

RTSP based Live Video Displayer

AP-RLD1004 Live Video Displayer

Hardware Specification

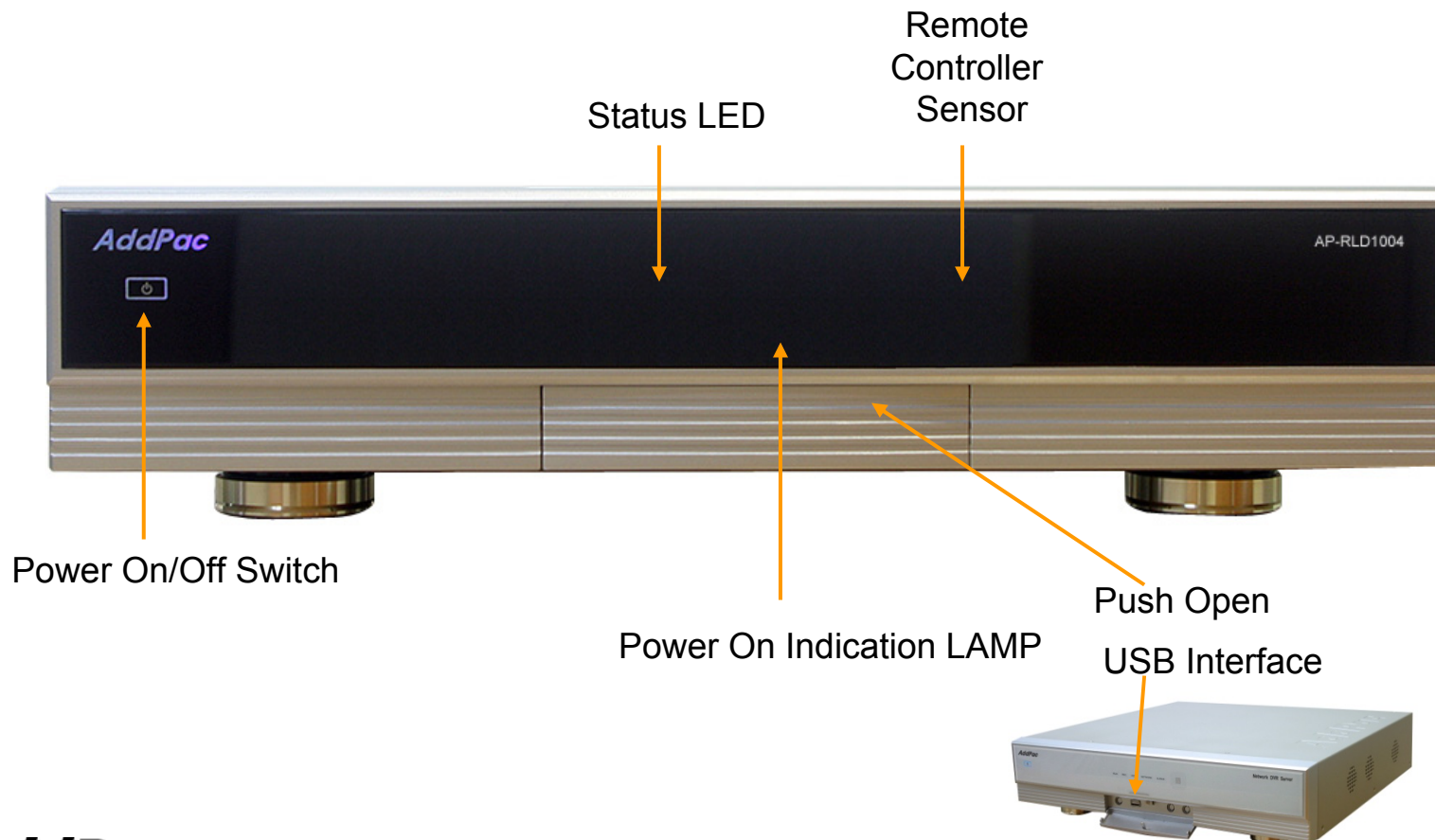

RTSP based Live Video Displayer

AP-RLD1004 Live Video Displayer

Hardware Specification

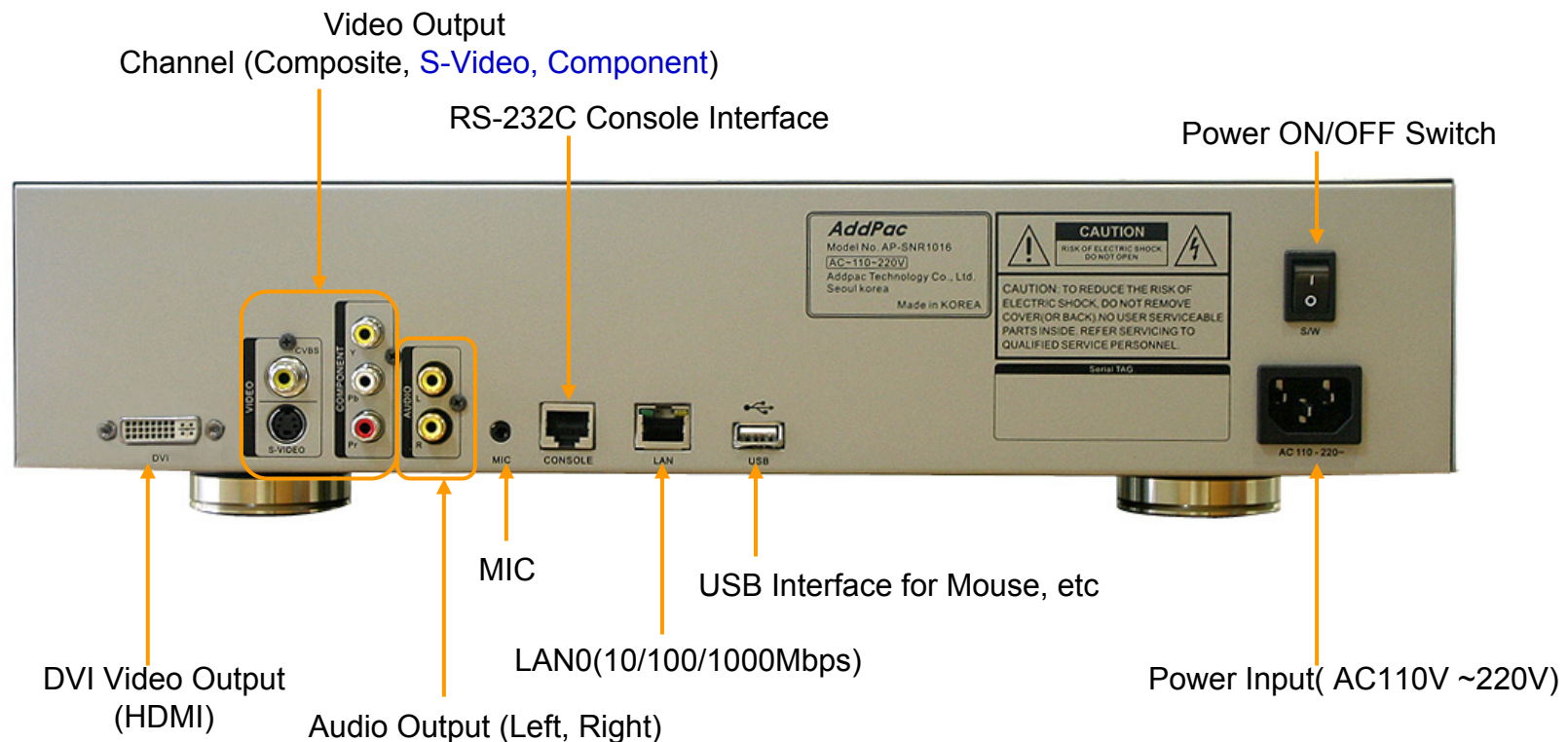



IP Emergency Call Solution for NDVR

IP Emergency Call Solution



Contents

- Network Diagram
- IP Emergency Call Solution for NDVR
 - AP-EIP50 IP Phone for Indoor Emergency Call
 - AP-EIP80 IP Phone for Outdoor Emergency Call
 - AP-EIP100 IP Phone for Indoor Emergency Call
 - IPNext Next Generation IP-PBX Series (example : IPNext600,etc)
 - AP-IP300 IP Phone for Emergency Call Attendant
 - Smart Office Console Software for Emergency Call Attendant
 - AP-NR500 Emergency Call Voice Recoding Server

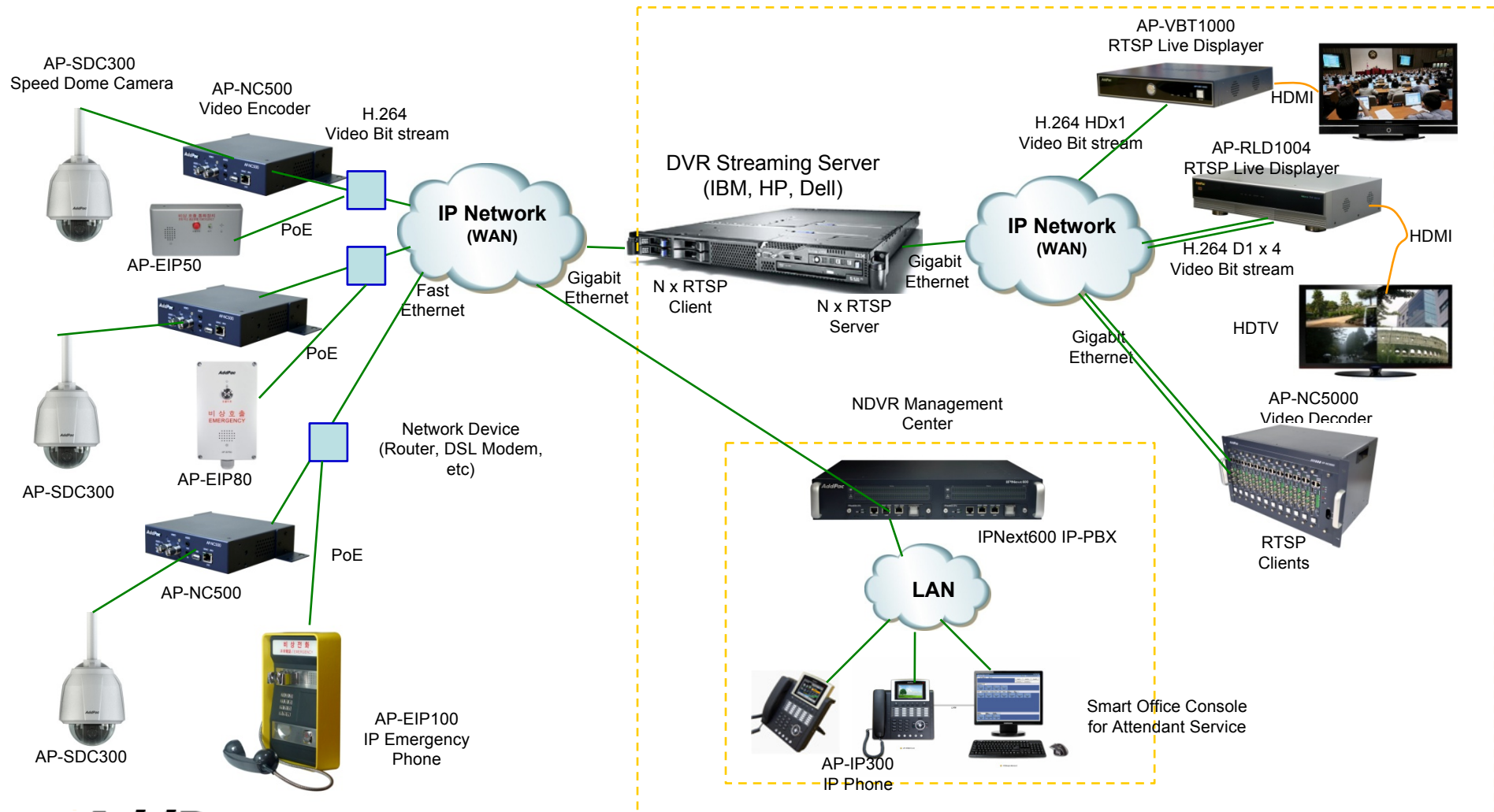
IP Emergency Call Network Diagram



IP Phones for Emergency Call

	AP-EIP50	AP-EIP80	AP-EIP100
Model			
Voice Codec	G.711,G.729,G.723.1	G.711,G.729,G.723.1	G.711,G.729,G.723.1
Duplex	Full Duplex	Full Duplex	Full Duplex
AEC	Support	Support	Support
Handset	N/A (MIC & Speaker)	N/A (MIC & Speaker)	Support
Protocol	SIP Protocol	SIP Protocol	SIP Protocol
Power Supply	PoE (Power over Ethernet)	PoE (Power over Ethernet)	PoE (Power over Ethernet)
Application	Indoor Application	Outdoor Application (Water Proof, etc)	Indoor Application

Next Generation IP-PBX for Attendant Service

IPNext600 NGN IP-PBX

Main Features

- SIP Application Server, Proxy, Registrar and Location Server
- Multiple ITSP Trunk with SIP & H.323 Accounts Support
- Dual System Redundancy Architecture
 - Two(2) Fast Ethernet Interface / System
- High Performance RISC Architecture
- Powerful Network Protocols (PPPoE, DHCP, Static Routing, etc)
- IPv4/IPv6 Dual Stack
- RTP Proxy Function Embedded for Private IP and IPv6 Address Interworking
- User Presence Service Features for Smart Multimedia Messenger and Smart IP Phone
- IVR Scenario Editor, Voice Mail, Media Service (Coloring), Conference
- Firmware Upgradeable Architecture
- Smart Multimedia Manager for IP-PBX Management
- Smart Messenger Service (click to dial) for Unified Communication
- VPMS (VoIP Plug&Play Management System) & Smart NMS for Large Scale Deployment
- Advanced Voice QoS Mechanism
- Dual Redundancy Power Module

Next Generation IP-PBX for Attendant Service

IPNext600 NGN IP-PBX

Hardware Specification

IPNext 600 Front Side

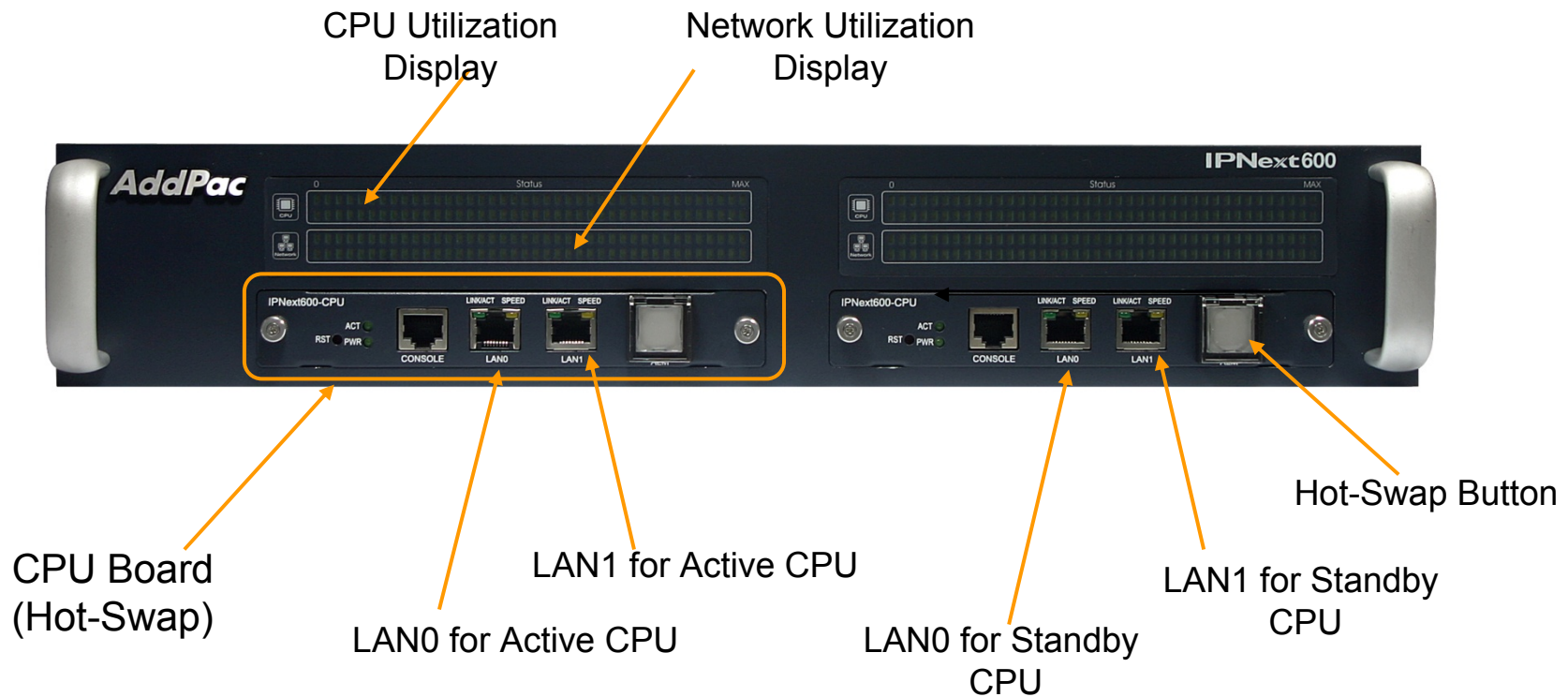

Next Generation IP-PBX for Attendant Service

IPNext600 NGN IP-PBX

Hardware Specification

IPNext 600 Back Side

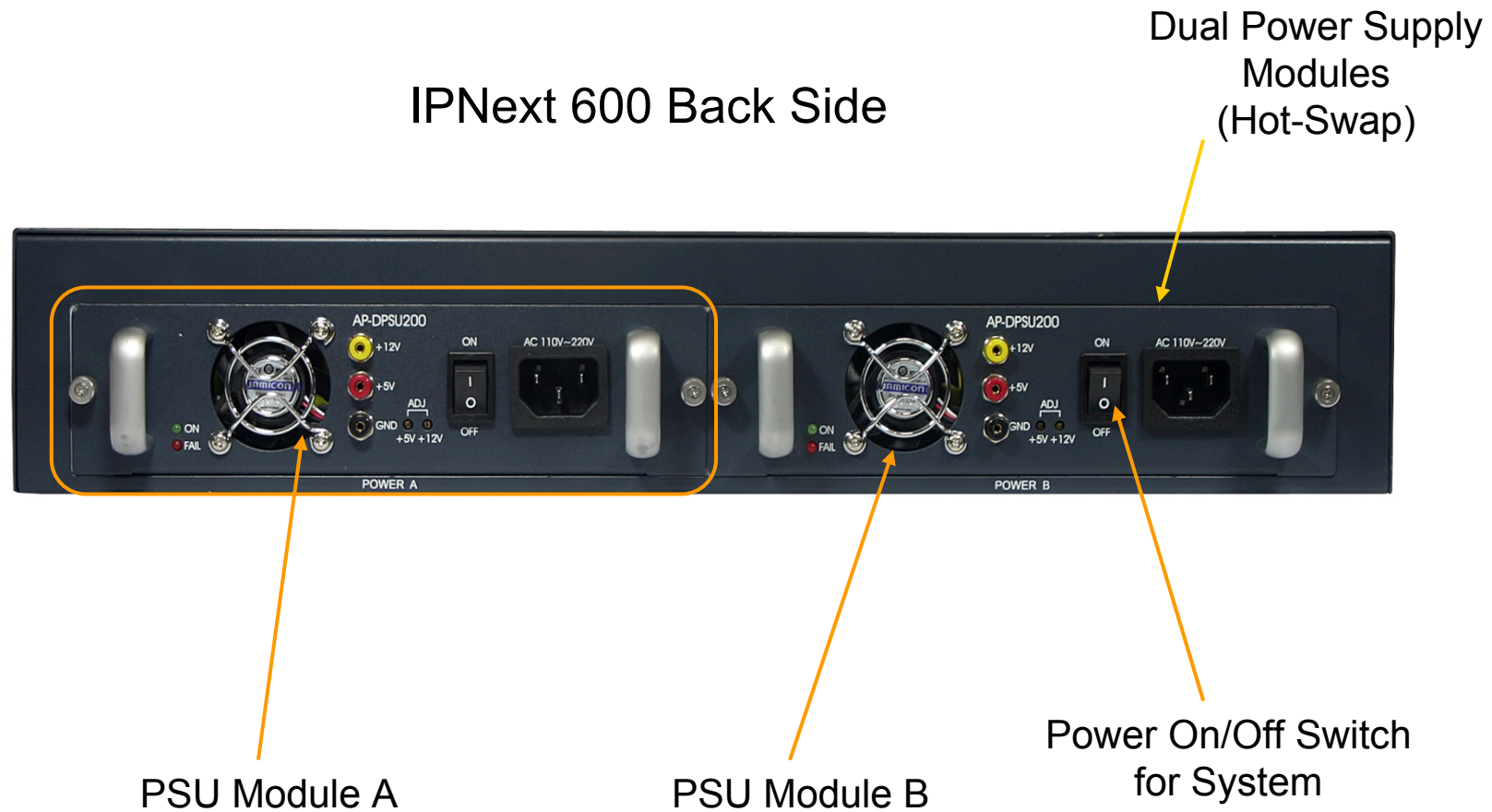

IP Phone for Emergency Call Attendant Service

AP-IP300 IP Phone

Main Features

- 4.3 Inch Color LCD Display
- External I/O Interface
 - Audio In/Out
 - Two(2) Fast Ethernet Interface
 - PSTN FXO Interface (optional)
- PoE (Power over Ethernet) Support
- 25 Speed Dial button with Presence Indication Lamp
- Audio Broadcasting Controller & Terminal
- Powerful Color GUI
- IPv4/IPv6 Address Support
- SIP, H.323 Signaling Support
- High-end Error Resilient Against Various Packet Error

IP Phone for Emergency Call Attendant Service

AP-IP300 IP Phone

Hardware Specification

- RISC+DSP Microprocessor Computing Power (Dual Processor Architecture)
- High Quality 4.3 Inch Color LCD Panel
- 25 Speed Dial Key & User Presence Indication LED
- Optional PSTN Backup Interface
 - FXO Interface
- High quality Audio and Voice Interface
 - Stereo Audio Input Connector
 - Stereo Audio Output Connector
- Network Interface
 - Two(2) 10/100Mbps Fast Ethernet
- USB Host Mode Interface
 - USB Memory(Flash, HDD), etc
- Power Supply
 - Power over Ethernet
 - External Power Adaptor (5V, 3A)

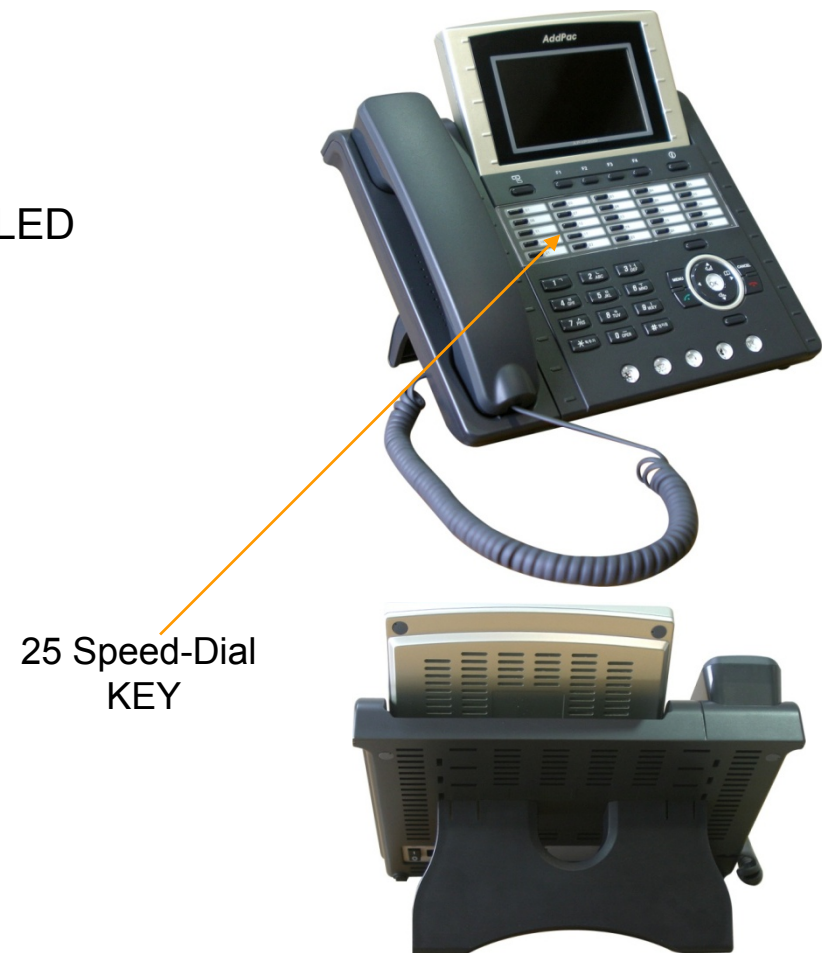

Smart Office Console for Emergency Call Attendant Service

Main Features

- MS-Window based Attendant Console
- Touch Screen Monitor Support
- AP-IP300 IP Phone Support
- Support Call Routing Service
 - Support User Presence Information
 - Support Phone Presence Information
 - Support Attendant Phone Call Control
 - Support Call Status Display
 - Support Group Call(Conference)
 - Support Various Monitoring Group

Smart Office Console for Emergency Call Attendant Service

Network Diagram

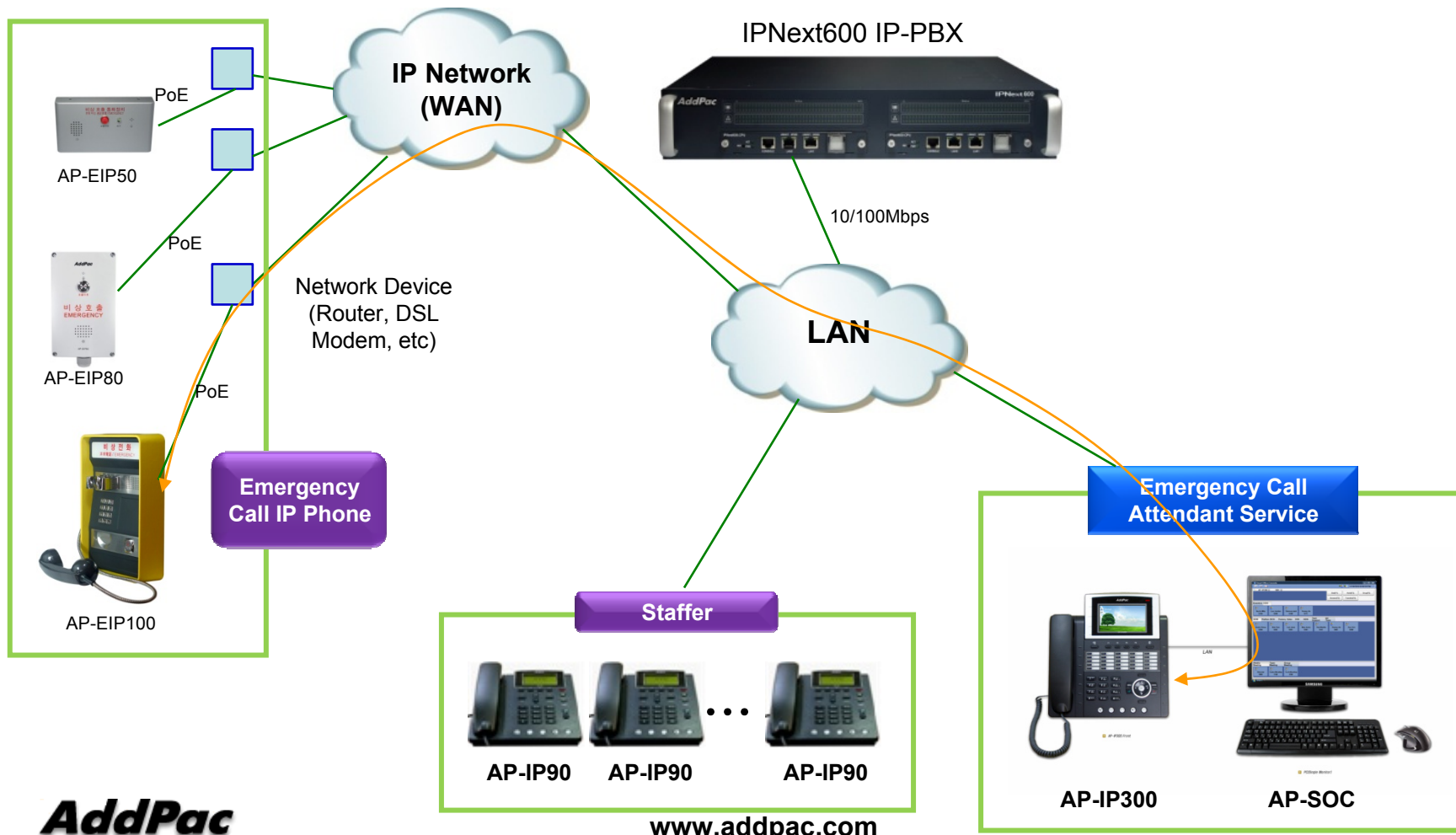

Emergency Call Voice Recording Server

AP-NR500 Network Voice Recording Server

Main Features

- IP based Network Voice Recording Server
- Powerful Management and User Friendly Features
- Fault Tolerant and Scalability Architecture
- High-performance Voice Recording Service
- Voice Transcoding (Up to 32 Channel) Function Support
- Smart DV_{oice}R Manager for AP-NR500 Management
- Firmware Upgradeable Architecture
- Two(2) Gigabit Ethernet Interface
- One(1) 3.5Inch IDE Type HDD Module Slot

Emergency Call Voice Recording Server

AP-NR500 Network Voice Recording Server

Hardware Specification

- RISC Microprocessor Computing Power
- Main Chassis
 - Network Interface
 - Two(2) 10/100/1000Mbps Gigabit Ethernet
 - One(1) RS-232C Console (RJ45)
 - USB Host Mode Interface for DVD Backup, etc
 - One(1) Hard Disk Interface Slot



Emergency Call Voice Recording Server

AP-NR500 Network Voice Recoding Server

- **Hard Disk Module**

AP-NR500 Front Side

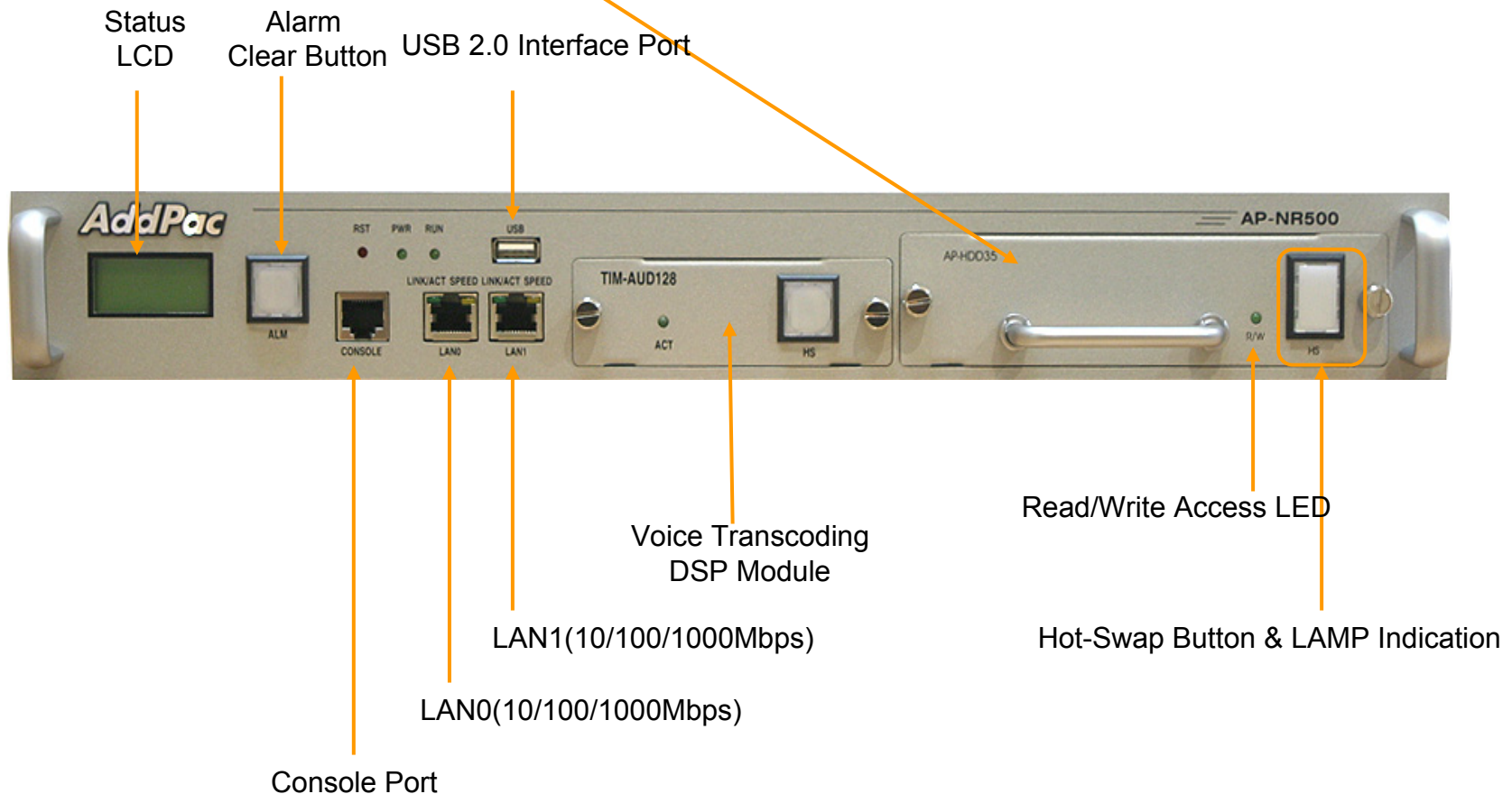

Emergency Call Voice Recording Server

AP-NR500 Network Voice Recording Server

Network Diagram

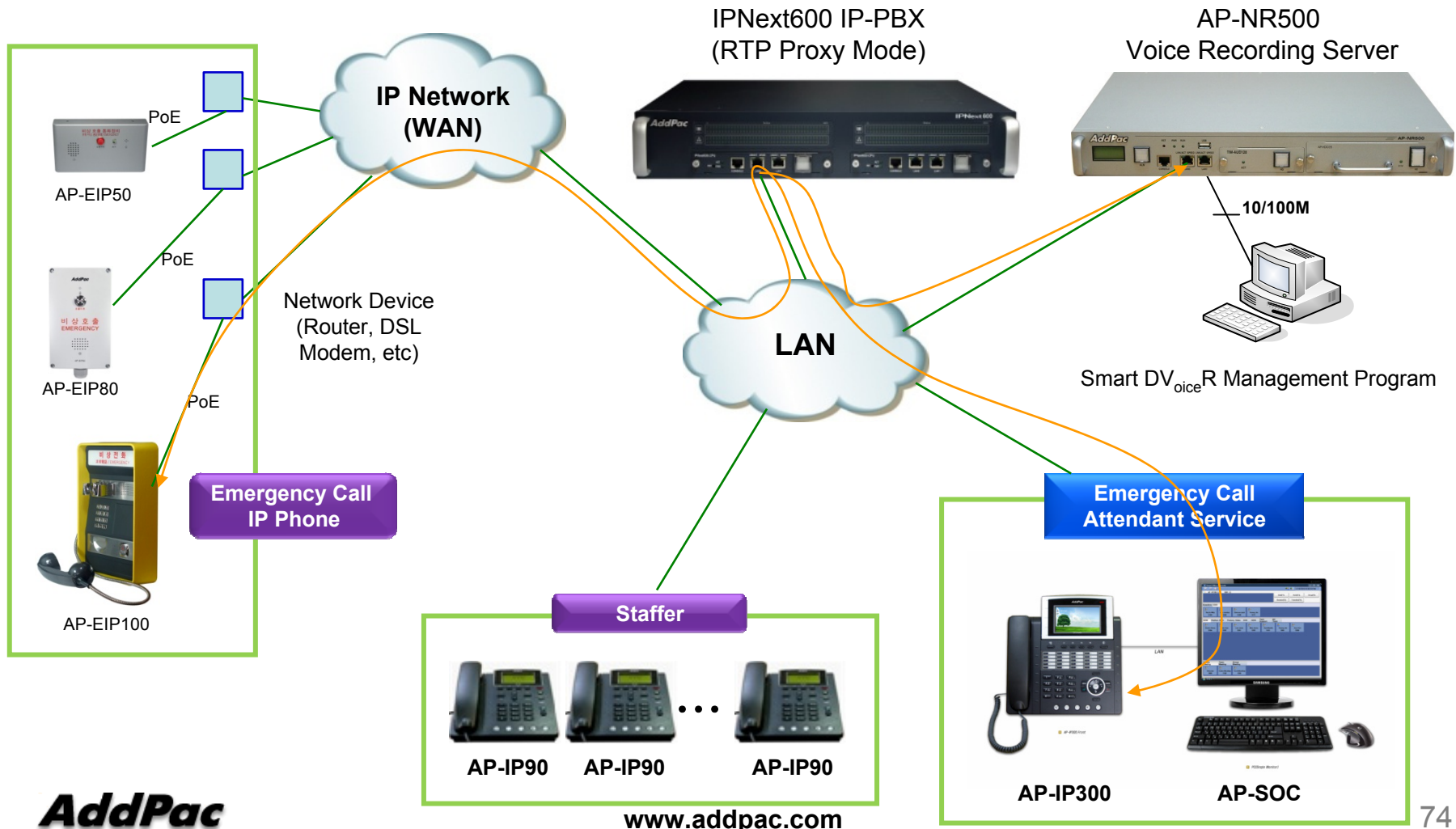

Smart DVoiceR Management Program

AP-NR500 Network Voice Recoding Server

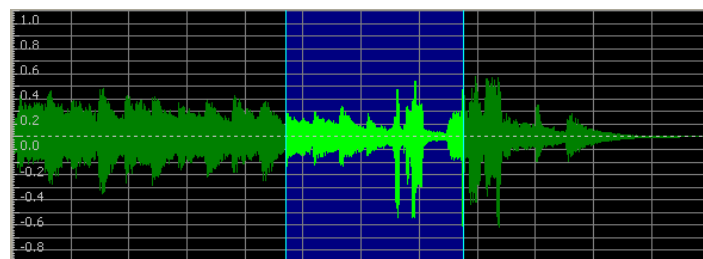
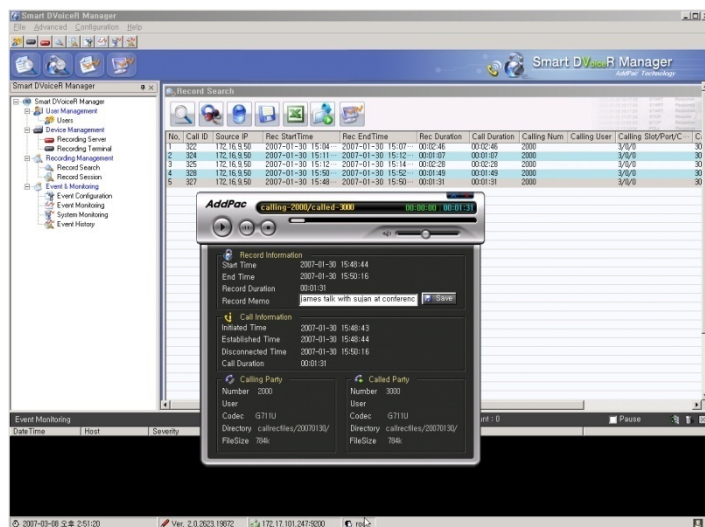

- Call History Management (search/modify/delete/save)
- Media Play Management (Play/Stop/Seek/Pause)
- Live Call List Management, Live Call Monitoring
- Local Backup (File Manager Support, PC HDD, DVD) and Local Play
- User Management (registration/modify/delete/search)
- Server Status (CPU/Memory/HDD) & Event Monitoring
- Waveform Analyzing Function
- Recording Source Management (VoIP Gateway, IP Phone, etc)
- Live Recording Board



Audio Broadcasting Solution for Emergency

IP Emergency Broadcasting Solution

Contents

- Network Diagram
- IP Audio Broadcasting Solution for Emergency
 - AP-AAT1000 AMP built-in Audio Terminal for NDVR
 - AP-AA1000N AMP built-in Audio Terminal Module
 - AP3120 Audio Broadcasting Server
 - MBMS Multimedia Broadcasting Software

IP Emergency Broadcasting Solution

Network Diagram

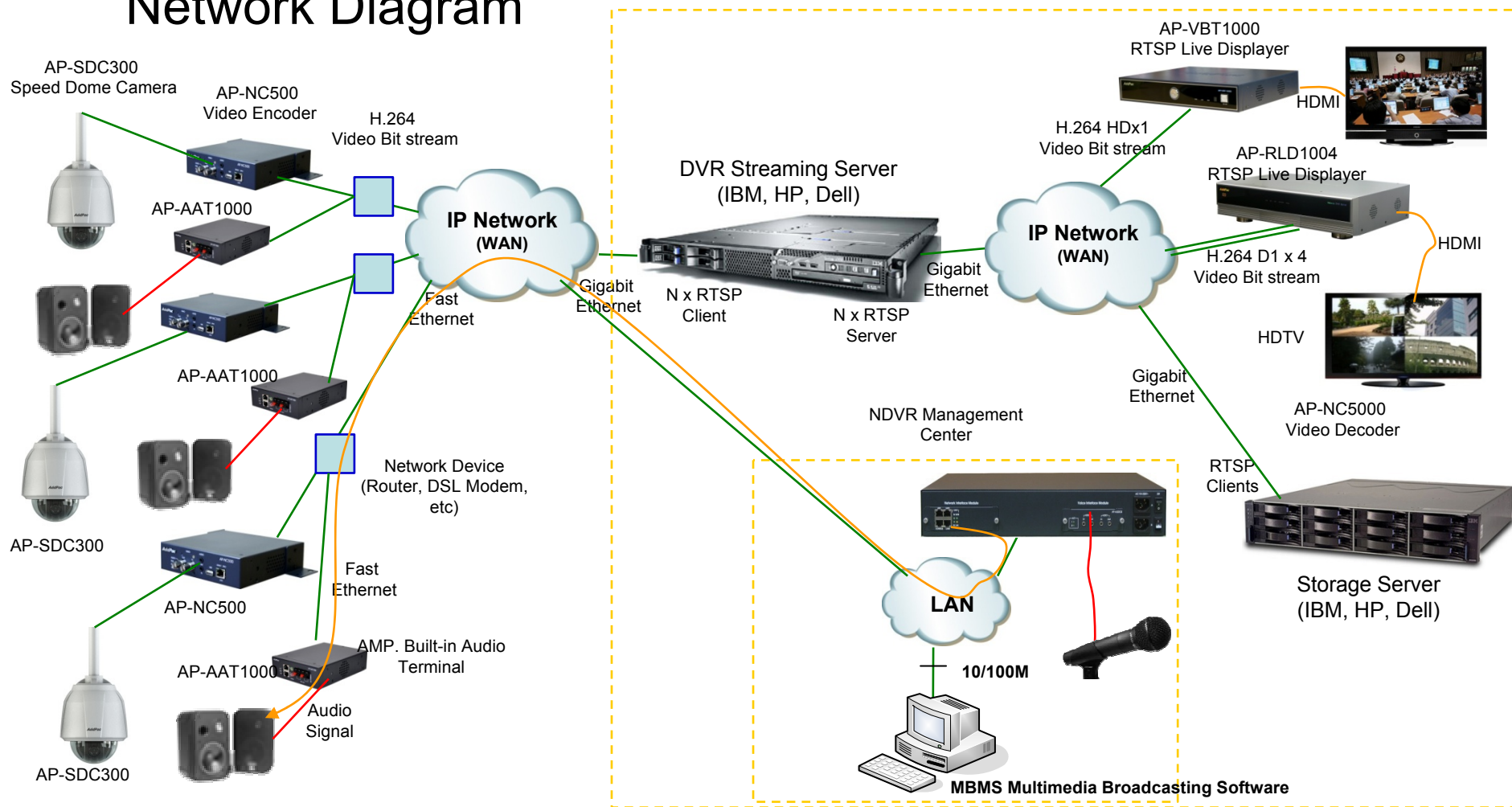

IP Emergency Broadcasting Solution

AP-AAT1000 AMP. Built-in Audio Terminal

Main Features

- IP based Audio Broadcasting
- AMP.(up to 100W) Built-in Audio Terminal for Speaker Direct Connection
- Audio Input Port Support for Video Codec Interworking
- IP and Analog Audio Port Both Support
- G.711/G.726 Voice Codec Support
- RTP/UDP Protocol Support
- IGMP Protocol Support for Multicasting
- Firmware Upgradeable Architecture
- One(1) Fast Ethernet Interface
- One(1) RS232C Port for CLI
- External Power Supply

IP Emergency Broadcasting Solution

AP-AAT1000 AMP. Built-in Audio Terminal

Hardware Specification

AP-AAT100 Front Side View

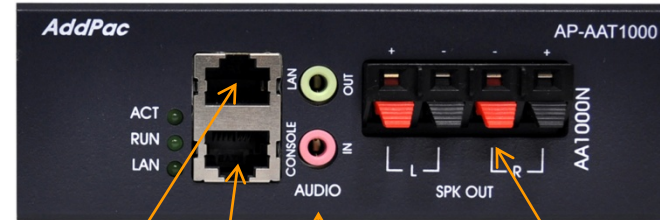

10/100Mbps Fast Ethernet

RS232C Console for CLI

Audio Input, Audio Output

Speaker Output

IP Emergency Broadcasting Solution

AP-AA1000N AMP. Built-in Audio Terminal Module

Main Features

- Audio Broadcasting Terminal Module for AP-NC1500 Target
- AMP.(up to 100W) Built-in Audio Terminal Module for Speaker Direct Connection
- Audio Input Port Support for Video Codec Interworking
- IP and Analog Audio Port Both Support
- G.711/G.726 Voice Codec Support
- RTP/UDP Protocol Support
- IGMP Protocol Support for Multicasting
- Firmware Upgradeable Architecture
- One(1) Fast Ethernet Interface
- One(1) RS232C Port for CLI

IP Emergency Broadcasting Solution

AP-AA1000N AMP. Built-in Audio Terminal Module

Hardware Specification

IP Emergency Broadcasting Solution

AP3120 Audio Broadcasting Server

Main Features

- IP based Audio Broadcasting Server
- Powerful Management and User Friendly Features
- Fault Tolerant and Scalability Architecture
- High-performance Audio Broadcasting Service
- Unicast and Multicasting Audio Broadcasting Service
- Point-to-Point Announcement Service
- Multi-Group/Multi-Session Broadcasting Service
- IGMP Protocol Support for Multicasting
- MBMS Software for AP3120 Management
- Firmware Upgradeable Architecture
- Two(2) Fast Ethernet Interface
- One(1) RS232C Port for CLI
- One(1) Audio Broadcasting Module Slot
- Various Audio Broadcasting Modules

IP Emergency Broadcasting Solution

AP3120 Audio Broadcasting Server

Hardware Specification

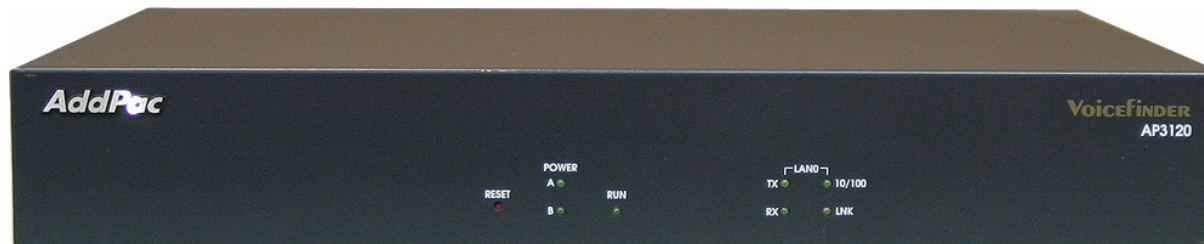

Network Module Slot



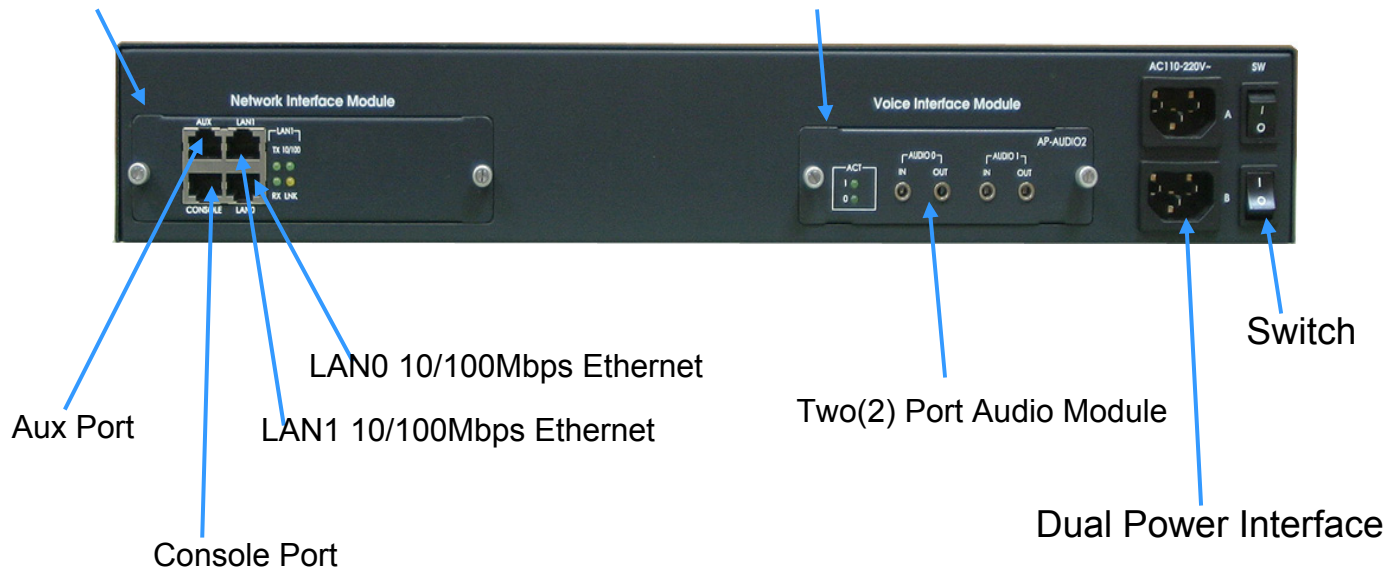

Voice Interface Slot



IP Emergency Broadcasting Solution

AP3120 Audio Broadcasting Server

Hardware Specification

Voice Modules	Module Features	Module Picture
AP-MP3	1-Pair Audio-In/Out Port, Direct MIC-In, Headphone High Quality Audio Band IP Broadcasting	
AP-AUDIO2	2-Pair Audio-In/Out Ports Voice Band IP Broadcasting	
AP-AUD1S3	1-Pair Audio-In/Out Ports, FXS Analog Interface Voice Band IP Broadcasting	
AP-AUD1S2O1	1-Pair Audio-In/Out Ports, FXS 2-Ports, FXO 1-Port Voice Band IP Broadcasting	



DVR Streaming Server (AP-SDS)

RTSP based NDVR Streaming Server

Contents

- Network Diagram
- RTSP based Network DVR Streaming Server
 - AP-SDS10000 NDVR Streaming Server
 - AP-SDS7000 NDVR Streaming Server
 - AP-SDS5000 NDVR Streaming Server

	AP-SDS5000	AP-SDS7000	AP-SDS10000
Platform	Embedded, APOS	Embedded, APOS	Commercial Server (HP, IBM, Dell, etc), Linux
Protocol	In :RTSP/TCP Out :RTSP/TCP,UDP	In :RTSP/TCP Out :RTSP/TCP,UDP	In :RTSP/TCP Out :RTSP/TCP,UDP
Performance (Basic Configuration)	HD(8M) : 16ch In, 32ch Out D1(1M) : 32ch In, 64ch Out	HD(8M) : 40ch In, 80ch Out D1(1M) : 80ch In, 160ch Out	HD(8M) : 64ch In, 128ch Out D1(1M) : 128ch In, 256ch Out
Module	4 Slot	10 Slot	N/A

RTSP based NDVR Streaming Server

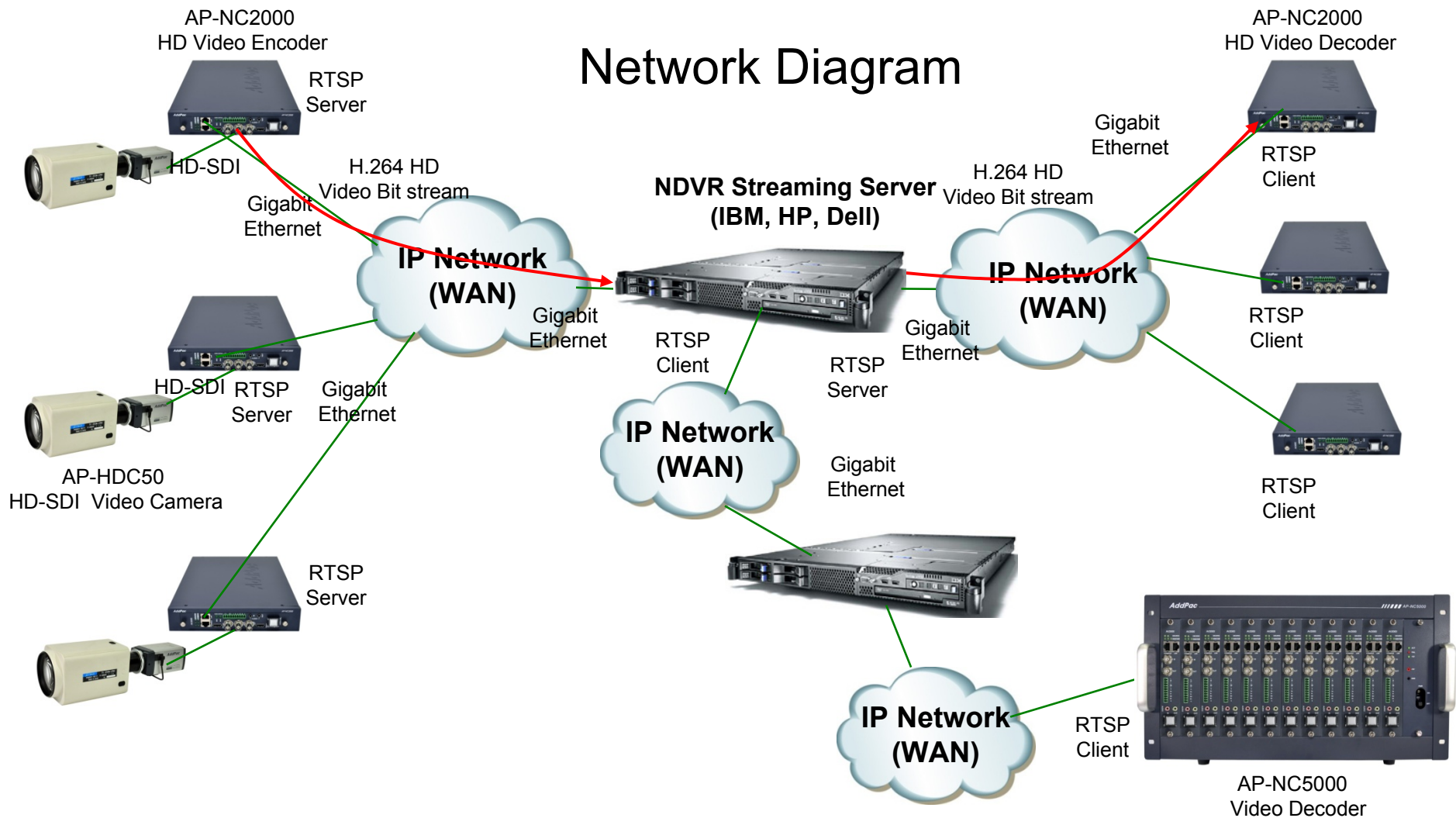

RTSP based NDVR Streaming Server

AP-SDS10000 NDVR Streaming Server

Main Features

- RTSP based HD Streaming Server
- Linux based Commercial Server Platform
- RTSP Server & Client Architecture
- RTSP Client : Video Decoder, Storage Server, Display Server Interworking, etc
- RTSP Server : Video Encoder Interworking
- Maximum 64 Channel HD Video Bit-Stream Input (~8 Mbps/ch)
- Maximum 128 Channel HD Video Bit-Stream Output
- Server Function for Web based Smart DVR Manager
- Video Solution with Outstanding Network Service Capability

RTSP based NDVR Streaming Server

AP-SDS10000 NDVR Streaming Server

Network Diagram

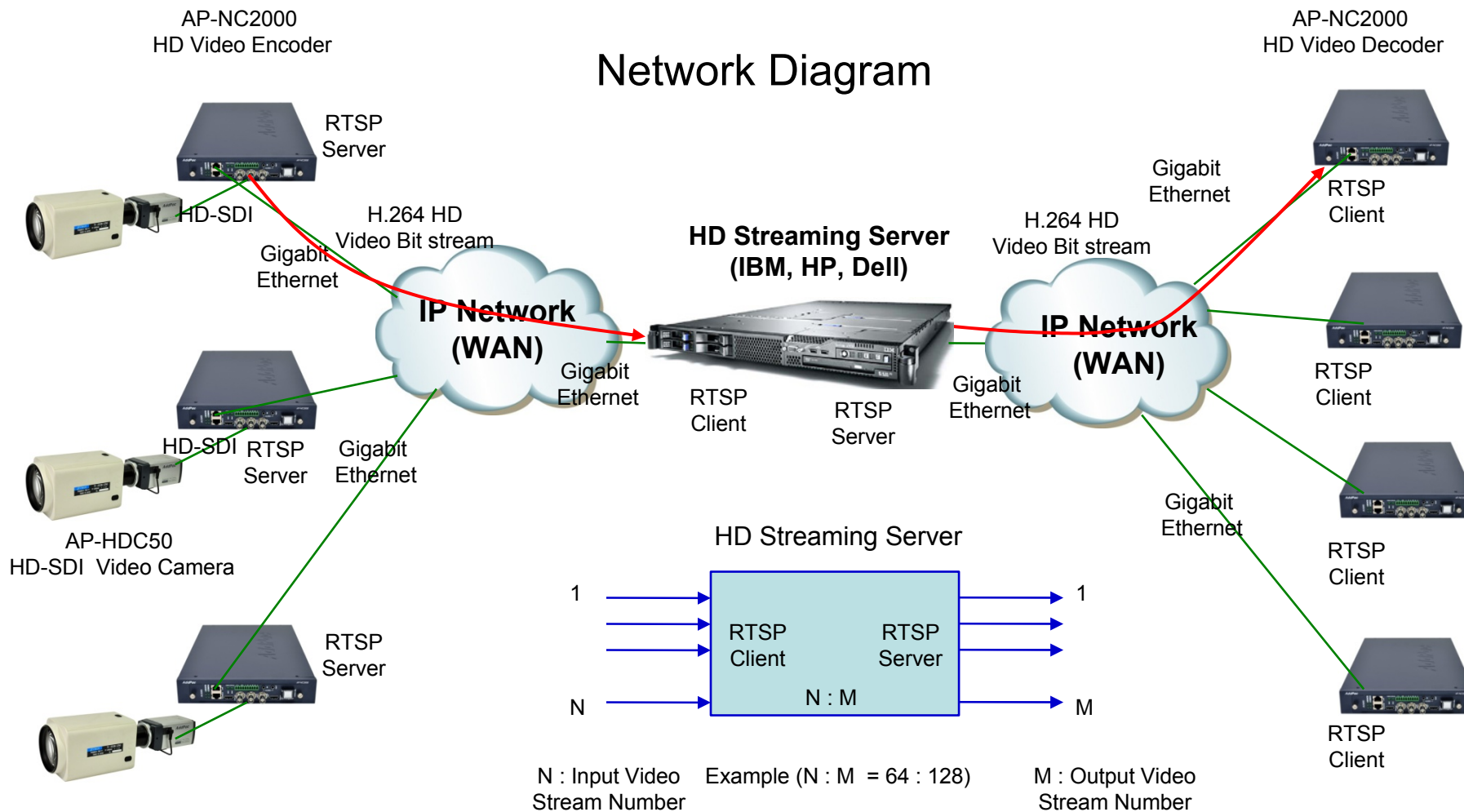

RTSP based NDVR Streaming Server

AP-SDS7000 NDVR Streaming Server

Main Features

- RTSP based NDVR Streaming Server
- High-End RISC Microprocessor Architecture
- Embedded Platform, Hot-Swap Modules
- Ten(10) Module Slots for Elementary Streaming Service Module
- Fault Tolerant and Scalability Architecture
- RTSP Server & Client Architecture
- RTSP Client : Video Decoder, Storage Server, Display Server Interworking, etc
- RTSP Server : Video Encoder Interworking
- Server Function for Web based Smart DVR Manager
- Video Solution with Outstanding Network Service Capability
- Dual Power Supply Module for Power Redundancy Service

RTSP based NDVR Streaming Server

AP-SDS7000 NDVR Streaming Server

AP-SDR7000 Streaming Service Modules

SS3000 Streaming Service Module
(Gigabit Ethernet)



RTSP based NDVR Streaming Server

AP-SDS7000 NDVR Streaming Server

Hardware Specification

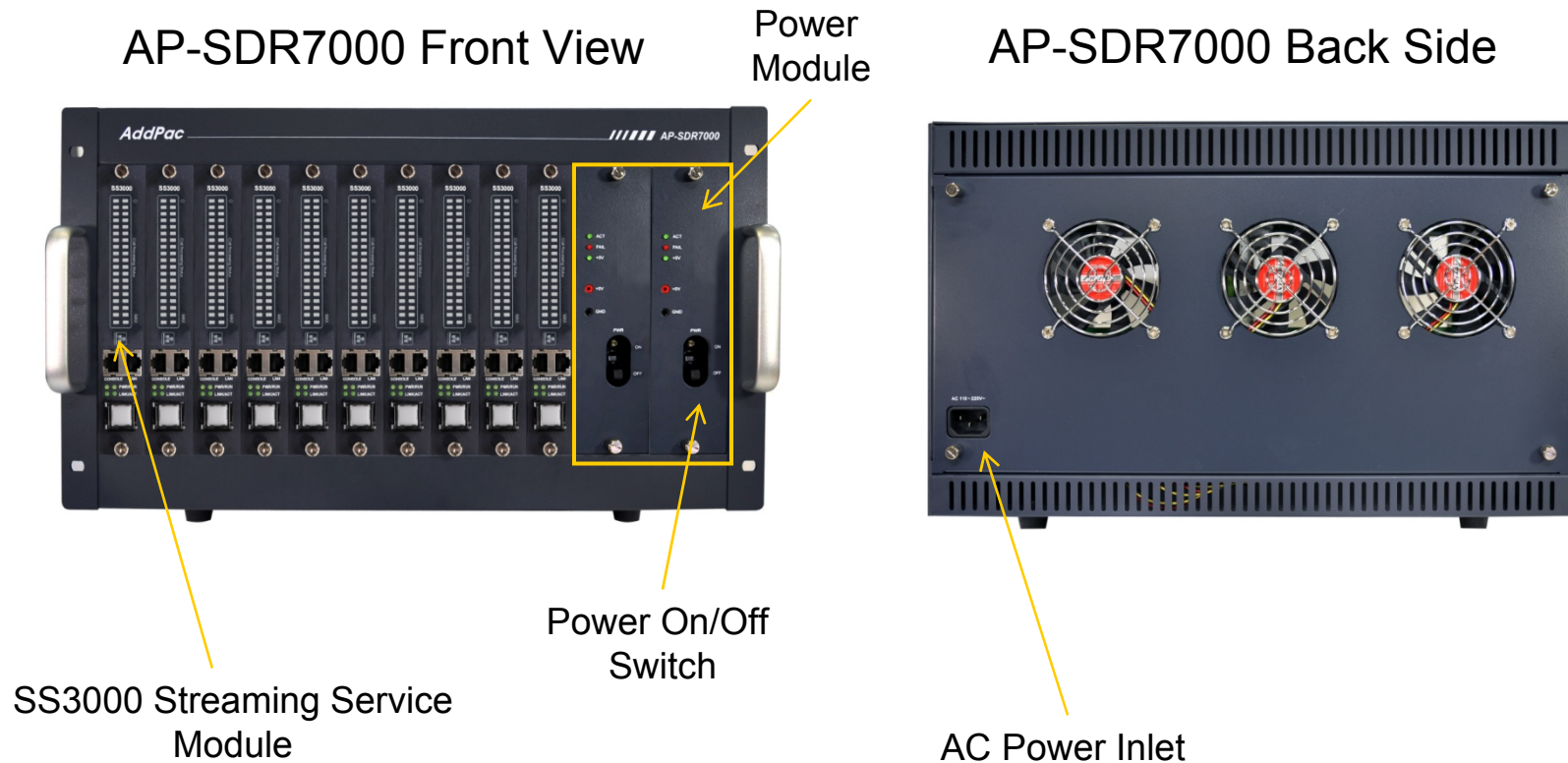

RTSP based NDVR Streaming Server

AP-SDS5000 NDVR Streaming Server

Main Features

- RTSP based NDVR Streaming Server
- High-End RISC Microprocessor Architecture
- Embedded Platform, Hot-Swap Modules
- Four(4) Module Slots for Elementary Streaming Service Module
- Fault Tolerant and Scalability Architecture
- RTSP Server & Client Architecture
- RTSP Client : Video Decoder, Storage Server, Display Server Interworking
- RTSP Server : Video Encoder Interworking
- Server Function for Web based Smart DVR Manager
- Video Solution with Outstanding Network Service Capability

RTSP based NDVR Streaming Server

AP-SDS5000 NDVR Streaming Server

AP-SDR5000 Streaming Service Modules

SS3000 Streaming Service Module
(Gigabit Ethernet)



RTSP based NDVR Streaming Server

AP-SDS5000 NDVR Streaming Server

Hardware Specification

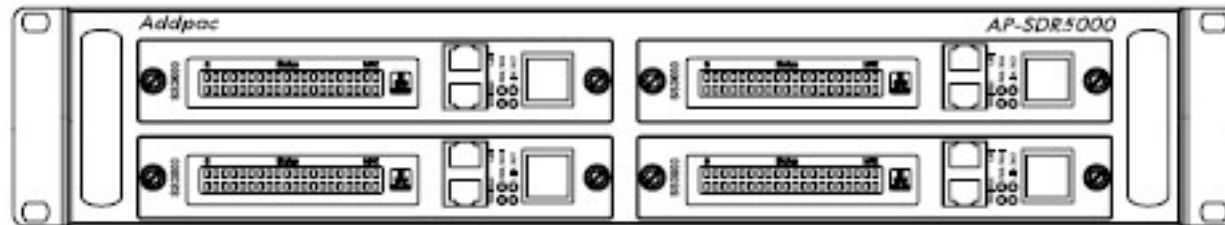



DVR Streaming Relay Server (AP-SDR)

NDVR Streaming Relay Server

AP-SDR10000 NDVR Streaming Relay Server

Main Features

- RTSP based HD Streaming Relay Server
- Linux based Commercial Server Platform
- RTSP Server & Client Architecture
- HD Streaming Server, HD Display Server Interworking
- Maximum 64 Channel HD Video Bit-Stream Input (~8 Mbps/ch)
- Maximum 128 Channel HD Video Bit-Stream Output
- Maximum 128 Input, 256 Output Channel (D1)
- Camera Database Information Support
- Smart DVR Viewer Support
- Video Solution with Outstanding Network Service Capability

NDVR Streaming Relay Server

AP-SDR10000 NDVR Streaming Relay Server

Network Diagram

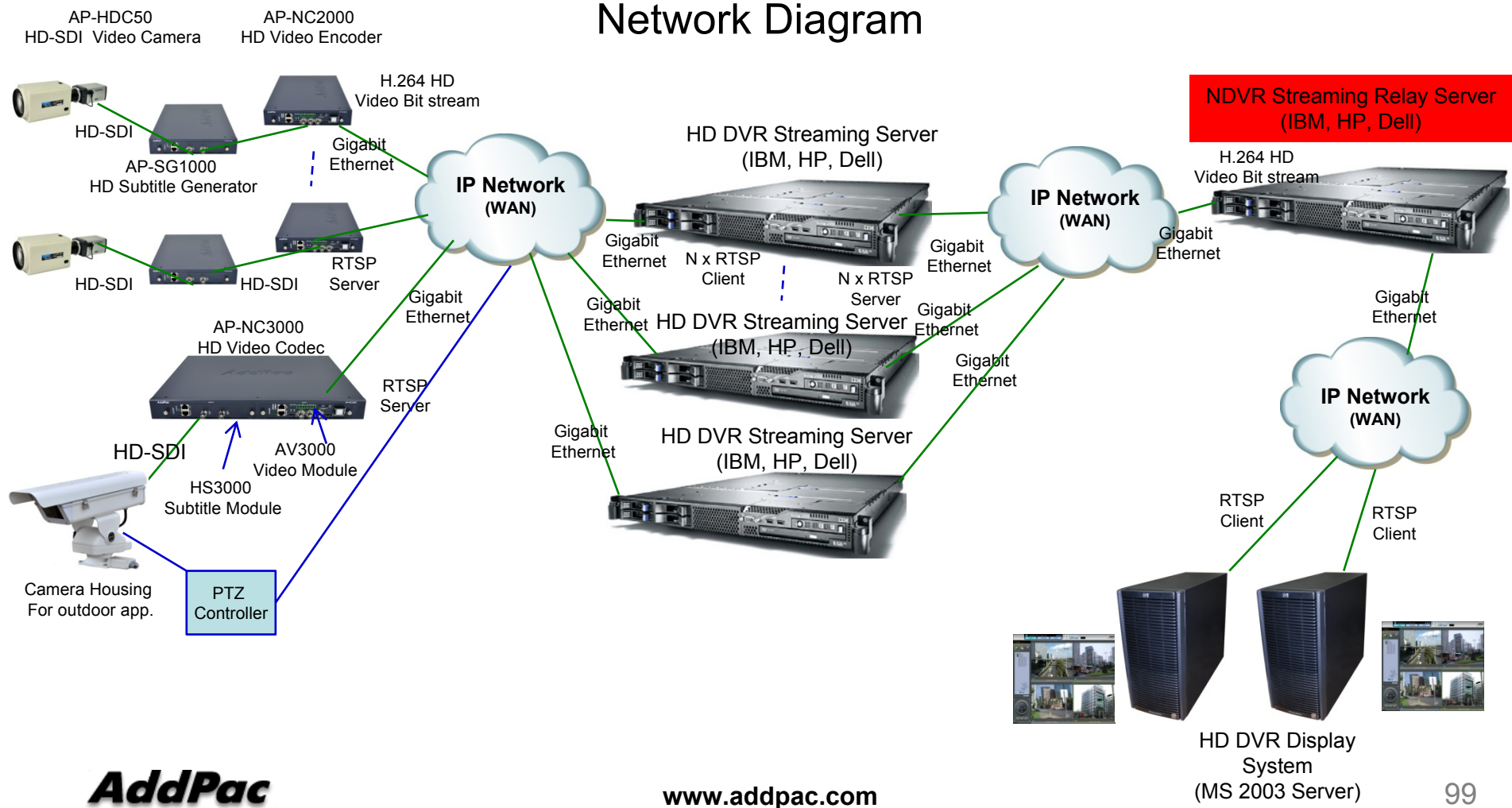



DVR Storage Server (AP-NR)

RTSP based NDVR Storage Server

Contents

- Network Diagram
- RTSP based Network DVR Streaming Server
 - AP-NR10000 NDVR Streaming Server
 - AP-NR5000L NDVR Streaming Server
 - AP-NR2000L NDVR Streaming Server

	AP-NR2000L	AP-NR5000L	AP-NR10000
Platform	Embedded, Linux	Embedded, Linux	Commercial Server (HP, IBM, Dell, etc), Linux
Protocol	RTSP/UDP	RTSP/UDP	RTSP/TCP,UDP
Performance (Basic Configuration)	D1(1M) : 16 Ch	D1(1M) : 16 Ch	HD(8M) : 16 Ch D1(1M) : 64 Ch
Module	10 Slot x 1 Shelf, 1 Slot : 500G HDD	10 Slot x N Shelf 1 Slot : 500G HDD	N/A

NDVR Storage Server

AP-NR10000 NDVR Recording Server

Main Features

- RTSP based HD Storage Server
- Linux based Commercial Server Platform
- RTSP Server & Client Architecture
- HD Display System Interworking
- HDD Capacity : User Requirement
- Server Function for Web based Smart DVR Manager
- Video Solution with Outstanding Network Service Capability

NDVR Storage Server

AP-NR10000 NDVR Recording Server

Network Diagram

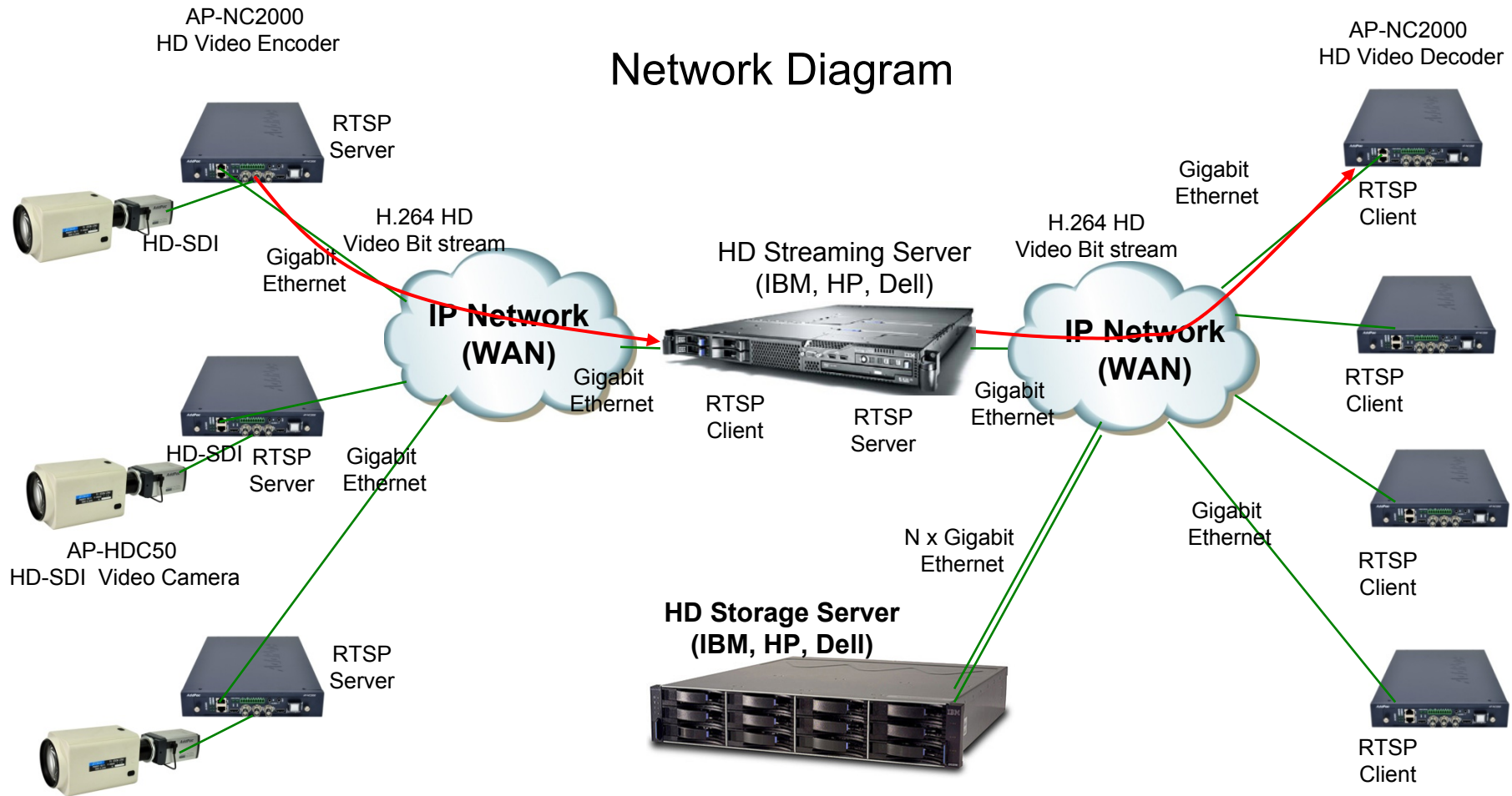



DVR Management Server (AP-SDMS)

DVR Management Server

AP-SDMS Smart DVR Management Server

Main Features

- Linux based Commercial Server Platform
- SDM(Smart DVR Manager) Web Server
- SSM(Smart Subtitle Manager) Web Server
- Smart DVR Streaming Server Interworking
- AP-SG1000(HS3000) HD Subtitle Generator Interworking
- PTZ Controller Interworking
- Video Solution with Outstanding Network Service Capability

DVR Management Server

AP-SDMS Smart DVR Management Server

Network Diagram

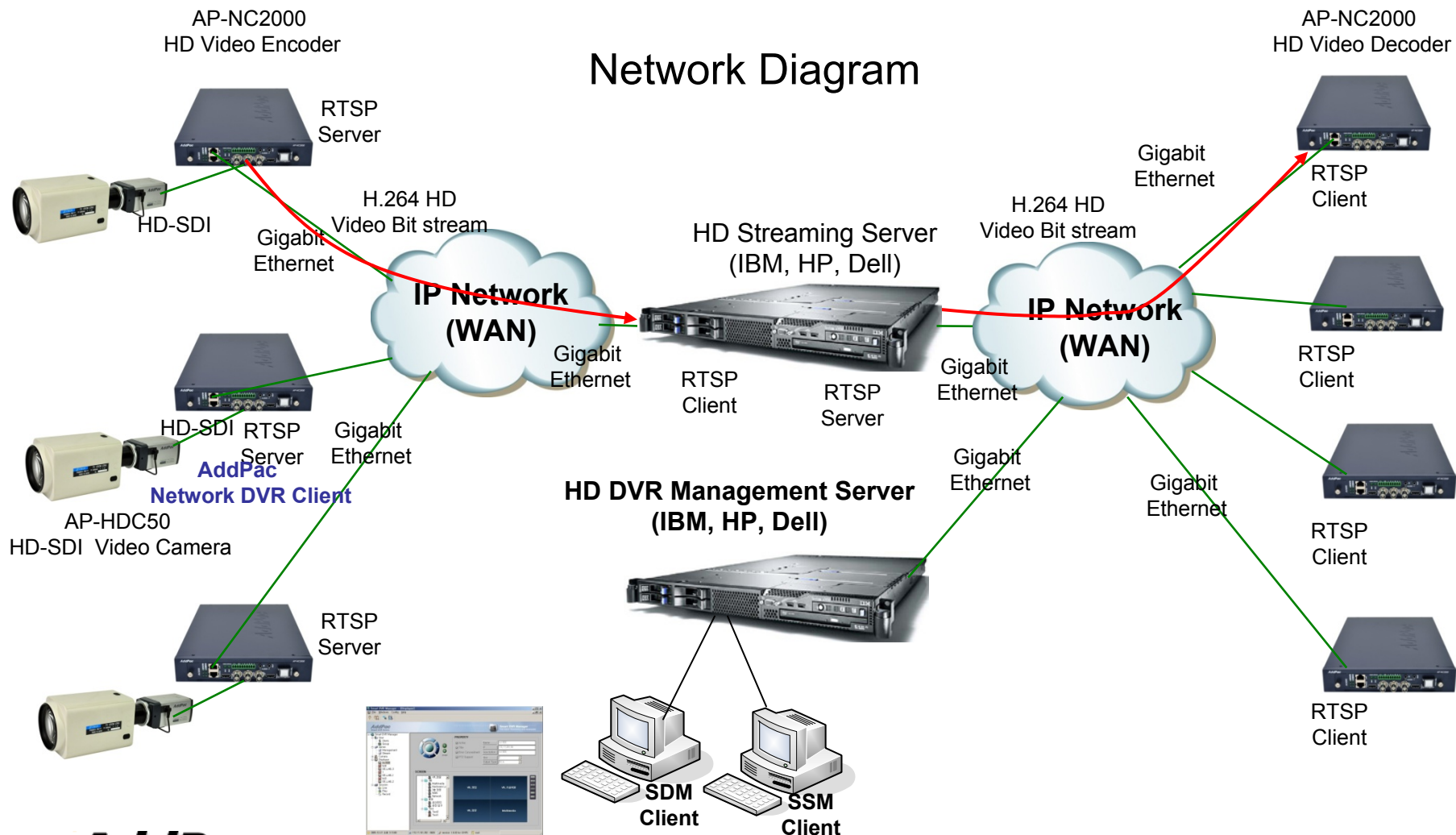

AddPac



www.addpac.com

DVR Management Server

AP-SDMS Smart DVR Management Server

Web based SDM Feature

- Login Management
- User and Group Management
- Management Server
 - CPU, Memory Utilization
 - Server IP address, Port , etc
- Network Camera Management
 - Registration, Model, IP address, PTZ Support, Video Encoder Control, etc

DVR Management Server

AP-SDMS Smart DVR Management Server

Web based SDM (screen capture)

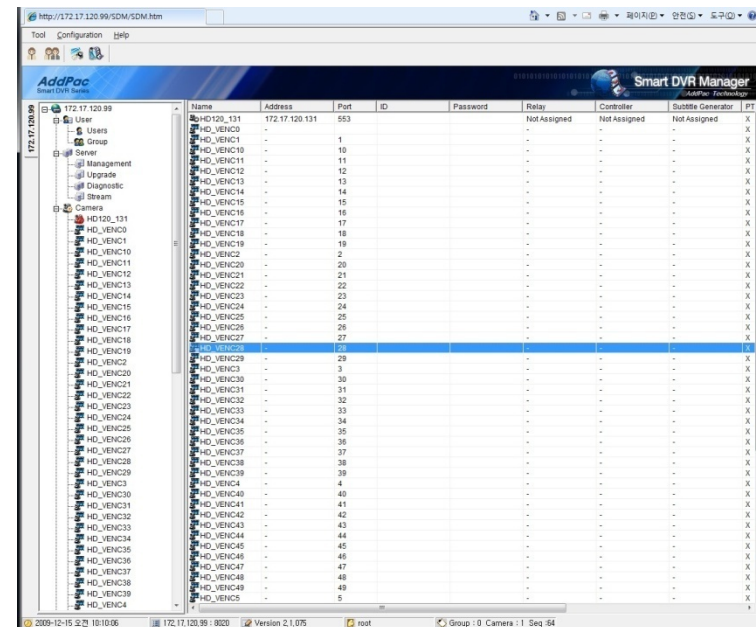
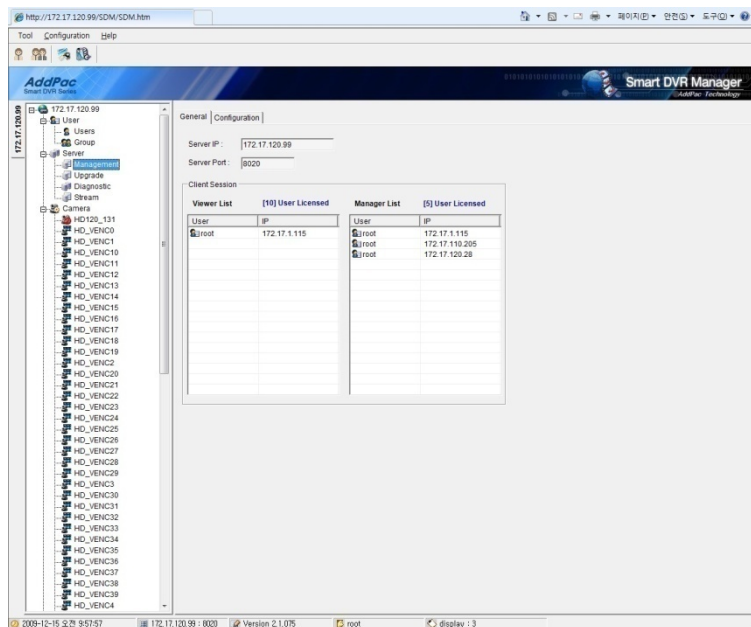

DVR Management Server

AP-SDMS Smart DVR Management Server

Web based SDM (screen capture)

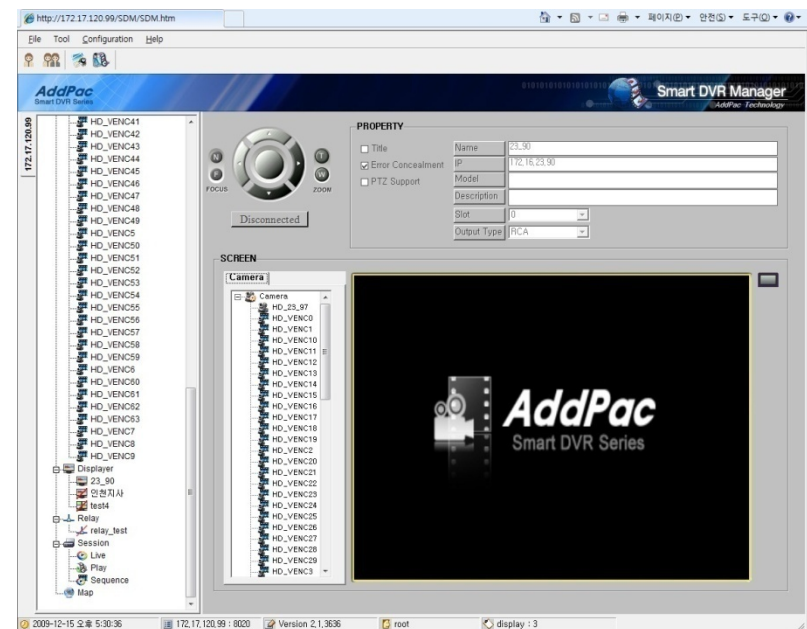
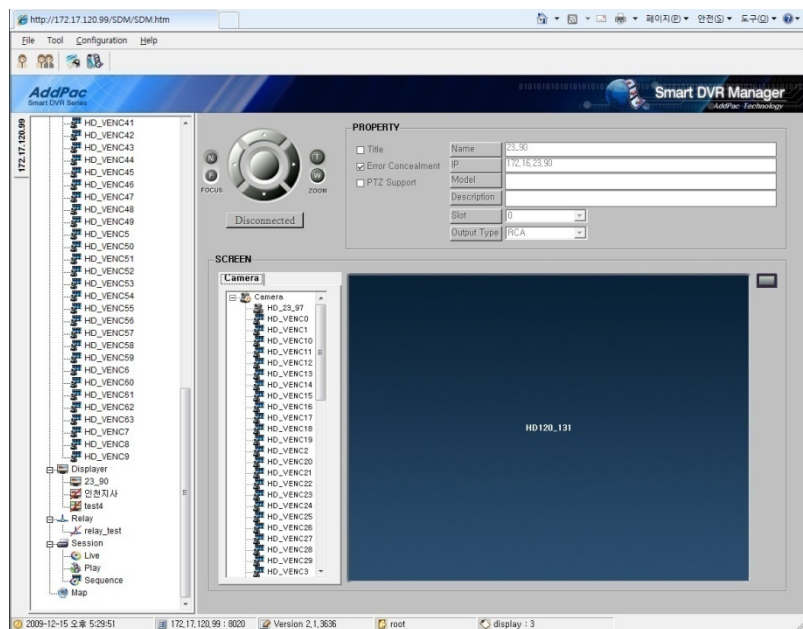

DVR Management Server

AP-SDMS Smart DVR Management Server

Web based SDM (screen capture)

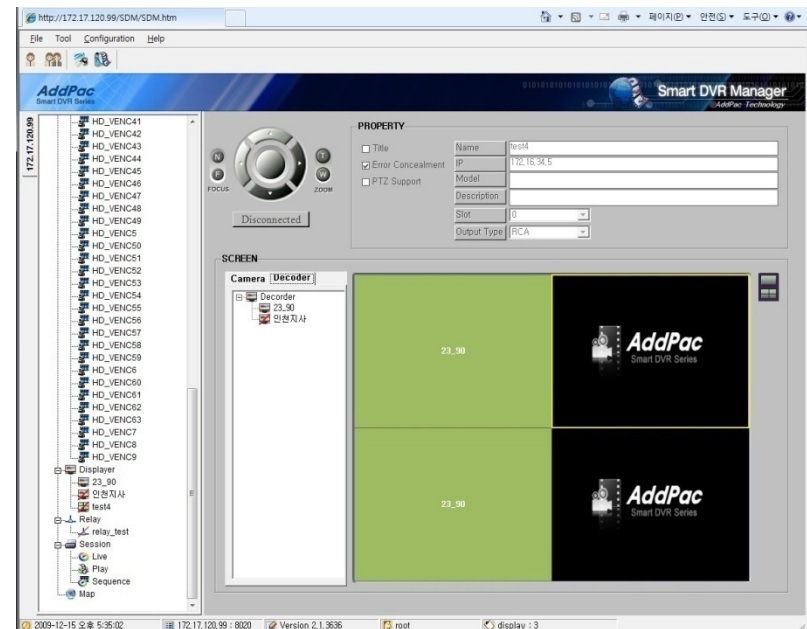
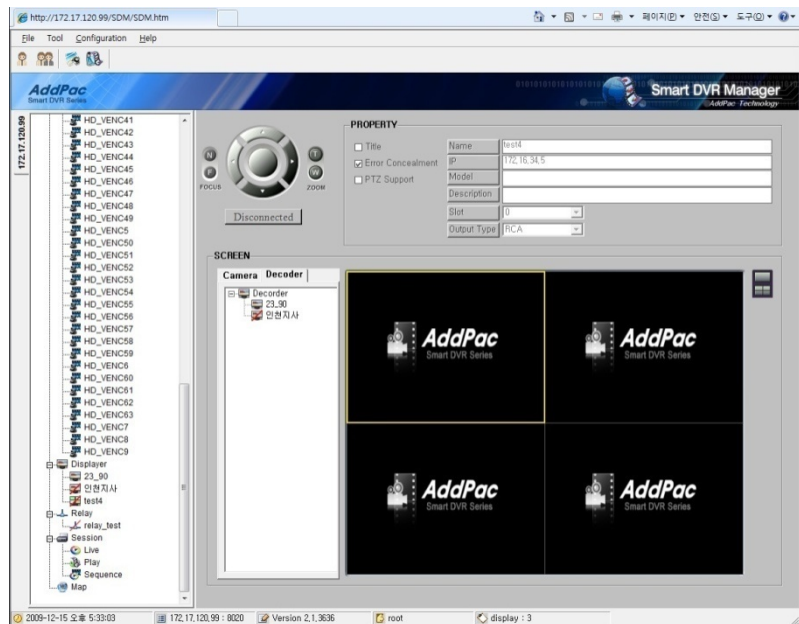

Ordering Information

- **Large Scale Network DVR Solution**
- **Including 1 Year Hardware Warranty**
- **Product Documents**
 - Install and Operation Guide (PDF)
- **Pricing**
 - AddPac Technology Regional Sales Manager
 - Authorized Sales and Marketing Representatives
 - Please Contact www.addpac.com



Thank you!

AddPac Technology Co., Ltd.
Sales and Marketing

Phone +82.2.568.3848 (KOREA)

FAX +82.2.568.3847 (KOREA)

E-mail sales@addpac.com