



AP3120 IP based Broadcasting System



2016

Technical Sales and Marketing

AddPac Technology

www.addpac.com



Contents

- What is IP Audio Broadcasting ?
- AddPac IP Audio Broadcasting Solution
- APOS™ for AP3120 IP Audio Broadcasting Server
- AP3120 System Overview
- AP3120 System Configuration
- AP3120 Management Scheme
- Network Configuration & Case Study
- Appendix

What is IP Audio Broadcasting ?

IP Audio Broadcasting Service Scheme

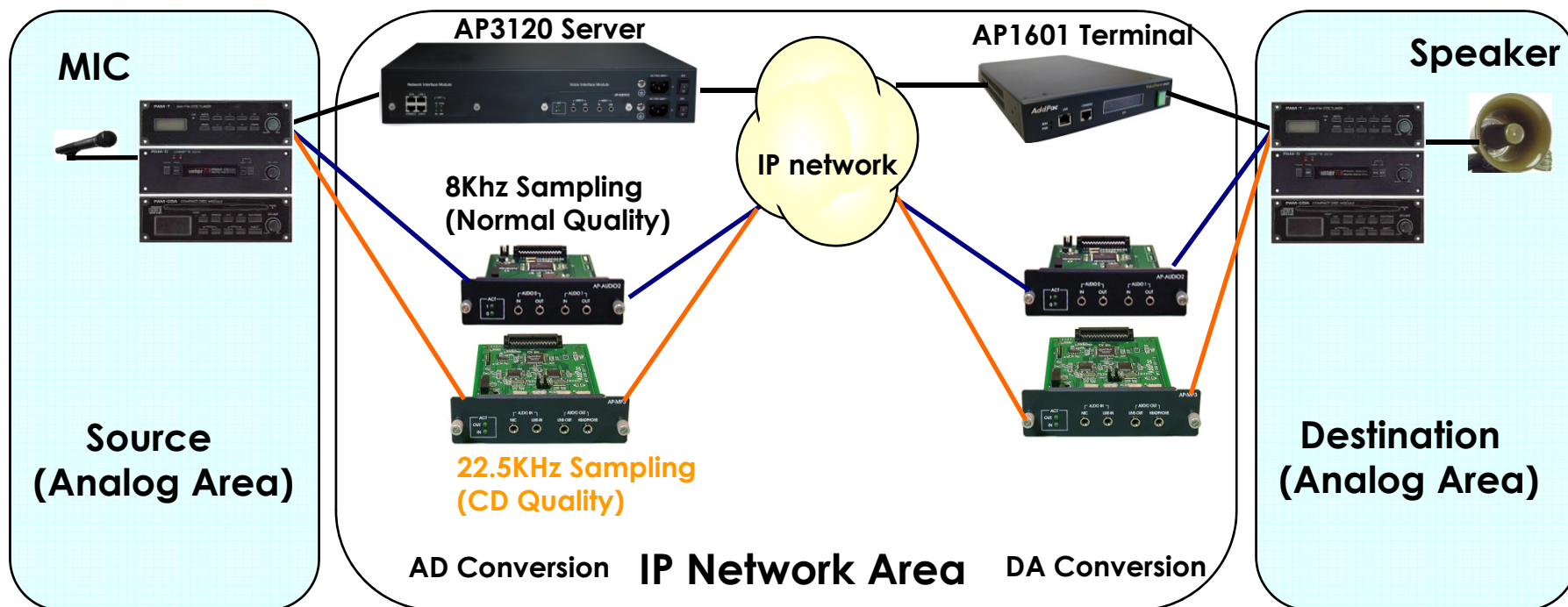

Item	Service Function	Support System
Source	Analog Audio → Audio stream	AP3120 (or Terminal Controlled by AP-BMS)
Relay	Copy Audio Stream to Multi-destinations	AP3120
Terminal	Audio Stream → Analog Audio	AP1601, AP2120, AP2520, AP2850 ...

What is IP Audio Broadcasting ?

IP Audio Broadcasting Message Flow

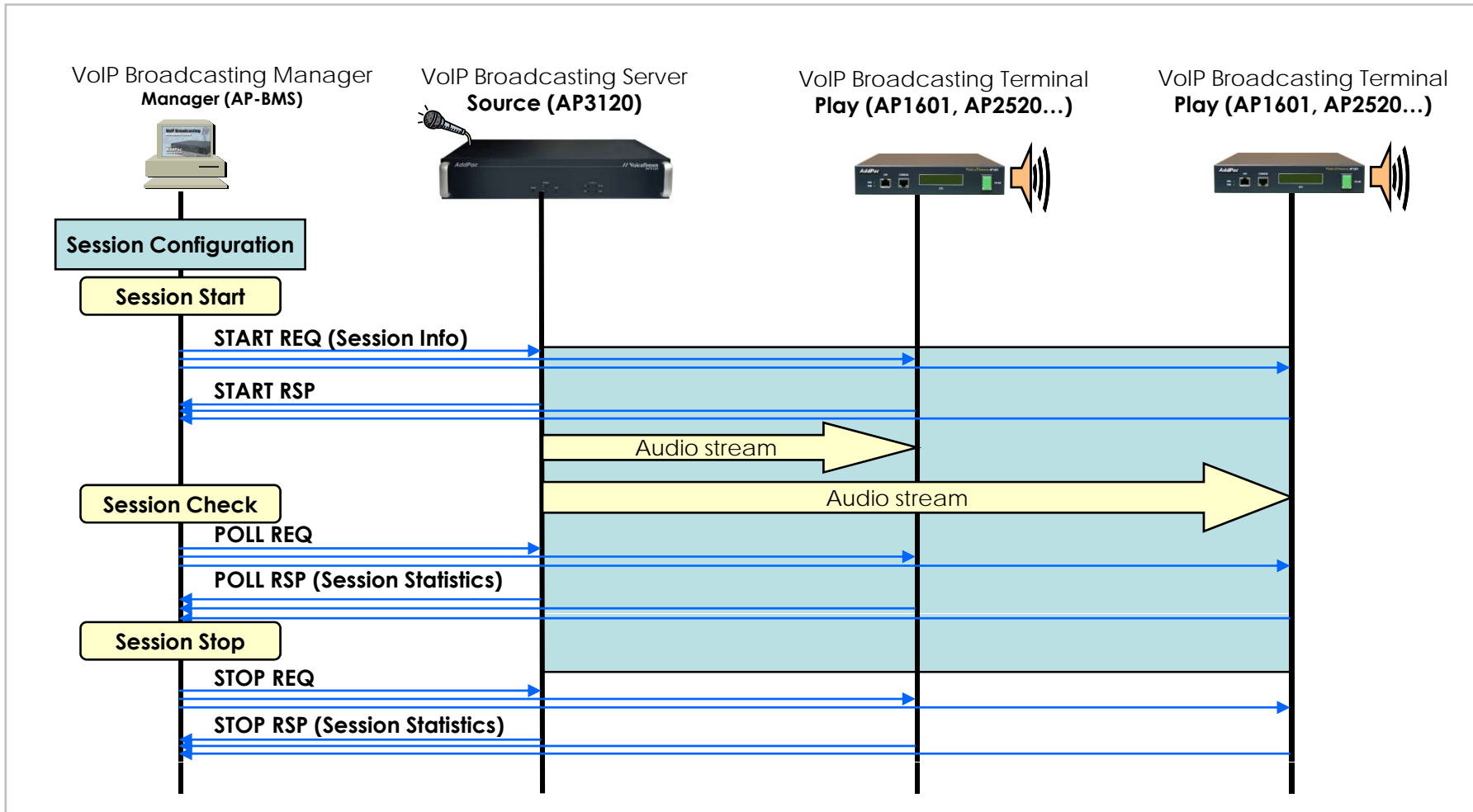

What is IP Audio Broadcasting ?







IP Audio Broadcasting Evolution

- **Beyond the existing Broadcasting System**
 - Realizing high quality broadcasting (From Voice level to audio level)
 - Utilizing reasonable IP network, replacing expensive voice-dedicated line
 - Eliminating Integration & Management difficulties
- **Extended Bandwidth & Contents**
 - Expanded Bandwidth and Various Contents
 - ADSL → VDSL → FTTH
 - Doubled bandwidth in one year
 - Internet arena asking for more than PC contents
- **To meet NGN arena based on IP network**
 - Intelligent communication system
 - Modularized, flexible architecture, adoptable to rapidly changing network environment
- **IP Broadcasting is the future of telephony service**
 - The Quality of telephony service will be upgraded in the future.
- **Multi Codec Support**
 - G.711 A-Law, G.711 U-Law / G.726 r16, G.726 r32 / G.729A / G.723.1 r63, G.723.1 r53



AddPac IP Audio Broadcasting Solution

IP Audio Broadcasting Components

	Model	Function	
Base Components	AP3120	<ul style="list-style-type: none"> ▪ Server ▪ Source broadcasting & relay ▪ Management 	
	AP1601, AP2xxx	<ul style="list-style-type: none"> ▪ Terminal ▪ Broadcasting receive & play 	
	AP-BMS	<ul style="list-style-type: none"> ▪ Manager ▪ GUI based broadcasting manage. 	
Option Components	AP-AUDIO2	<ul style="list-style-type: none"> ▪ Voice Band Audio ▪ 2Pair audio in/out interface module 	
	AP-AUD1S3	<ul style="list-style-type: none"> ▪ Voice Band Audio + VoIP Interface ▪ 1Pair audio in/out+FXS3 voice ports 	
	AP-AUD1S2O1	<ul style="list-style-type: none"> ▪ Voice Band Audio + VoIP Interface ▪ 1audio in/out+FXS2+FXO1 voice ports 	
	AP-PSB	<ul style="list-style-type: none"> ▪ Power Switching Box ▪ Remote side AMP power manage. 	

AddPac IP Audio Broadcasting Solution

IP Audio Broadcasting Products

All Embedded Broadcasting Solution

Server Side Solution

AP3120 IP Audio Broadcasting Server



Terminal Side Solution

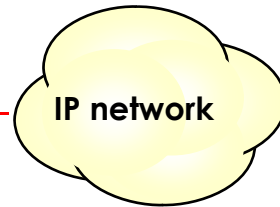

PC based Management Scheme



AP-BMS Broadcasting Manager Software

Optional Audio Module Solution



AP-AUDIO2 Module



AP-AUD1S3 Module



AP-AUD1S2O1 Module

Accessory for AMP. Power Control



AP-PSB Power Switching Box

The Vision of Next Generation Audio Broadcasting

APOS™ (AddPac Operating System) Introduction for AP3120 IP Audio Broadcasting Server

AP3120



AddPac

www.addpac.com

8

Aug. 2003, IP based Broadcasting System Presentation R1.00

APOS™ for IP Audio Broadcasting Server

APOS™ Internetworking Protocol Stack

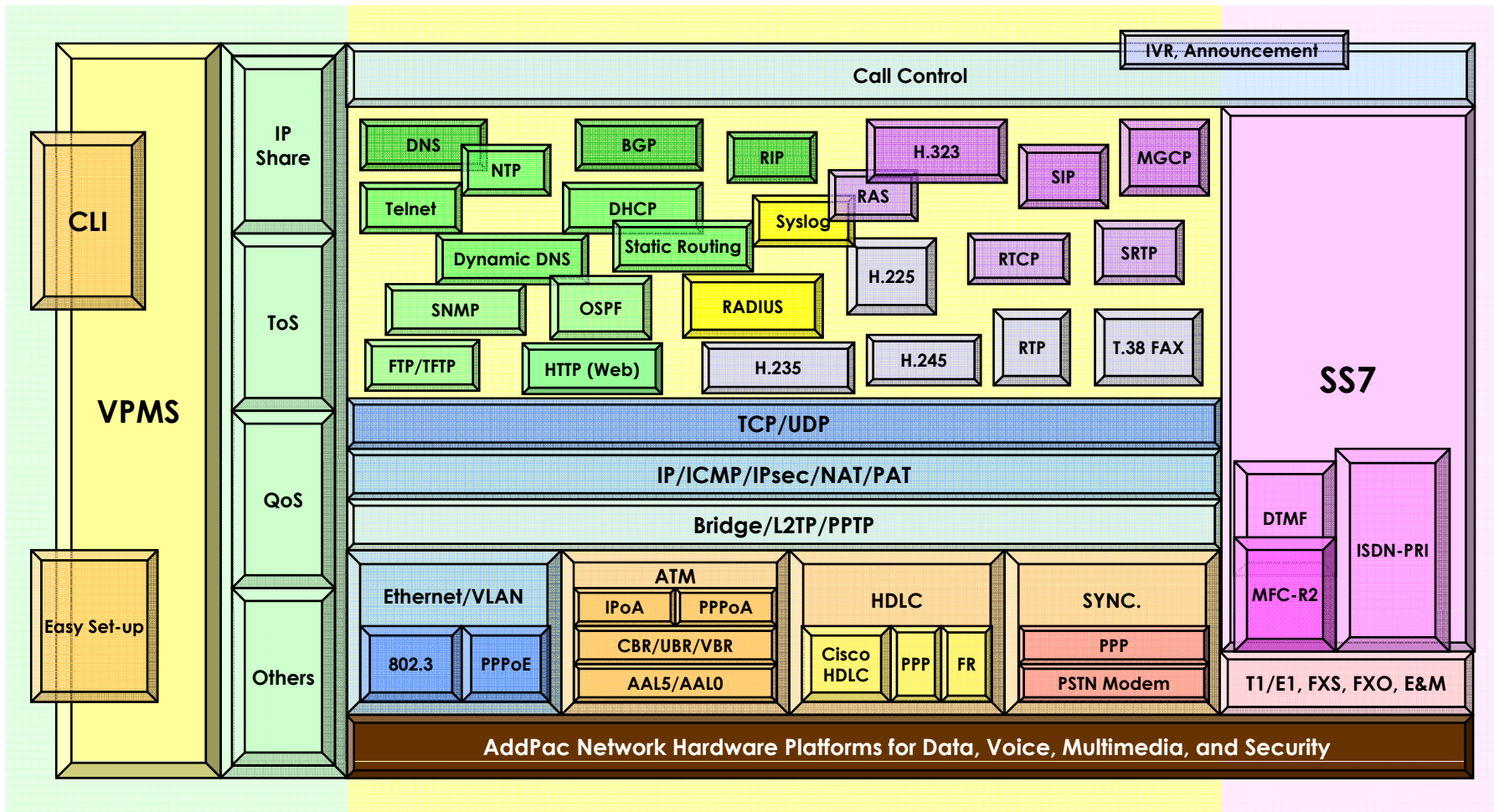

APOS™ for IP Audio Broadcasting Server

APOS™ Internetworking SW World (1)

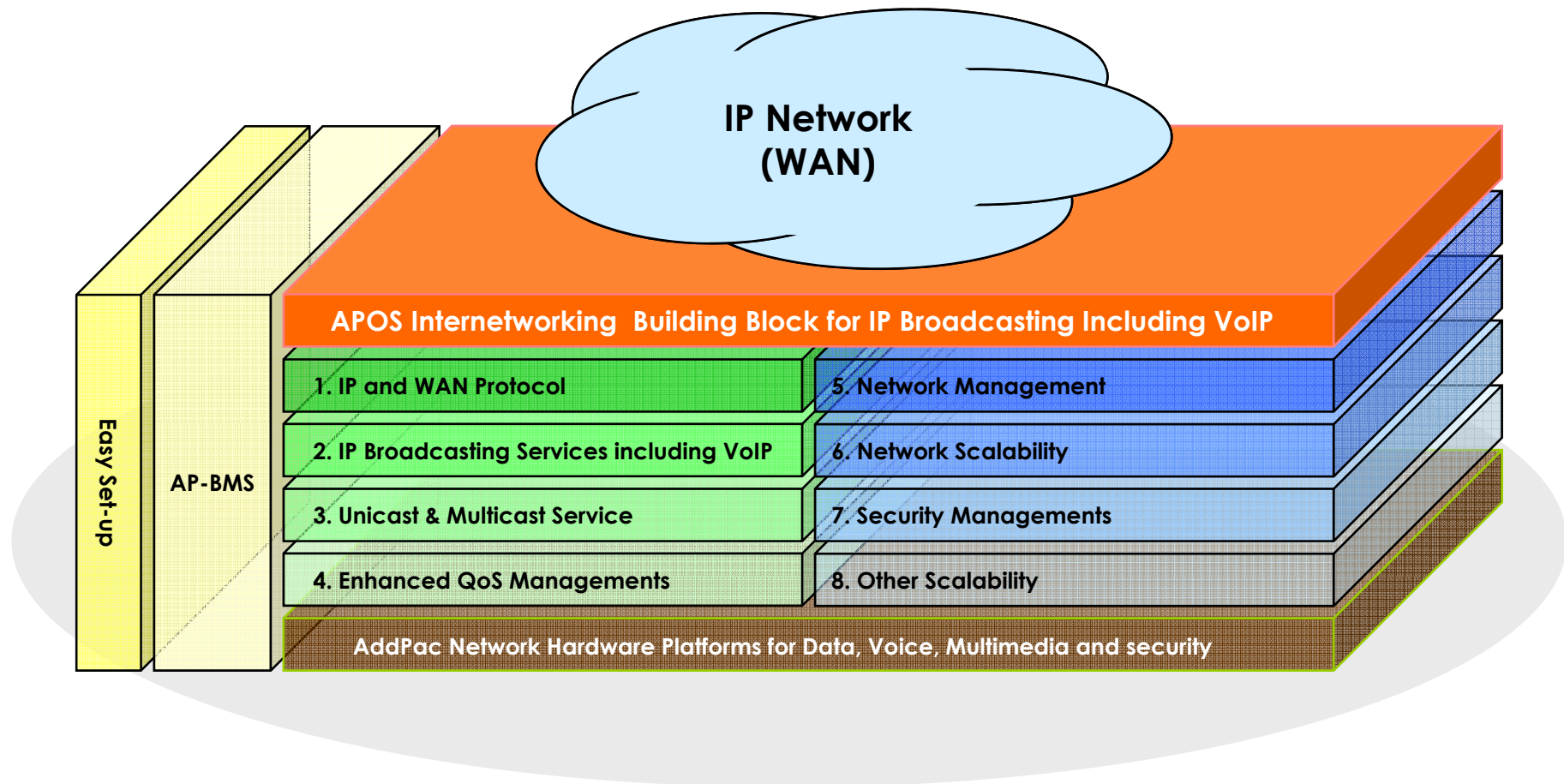

APOS™ for IP Audio Broadcasting Server

APOS™ Internetworking SW World (2)

• APOS Internetworking Software World

- AddPac Operating System (APOS)
- Support Industry Standard
- Integrated Networking Protocols
- Optimized Performance & Functionality
- Easy to use, Installation, and Maintenance

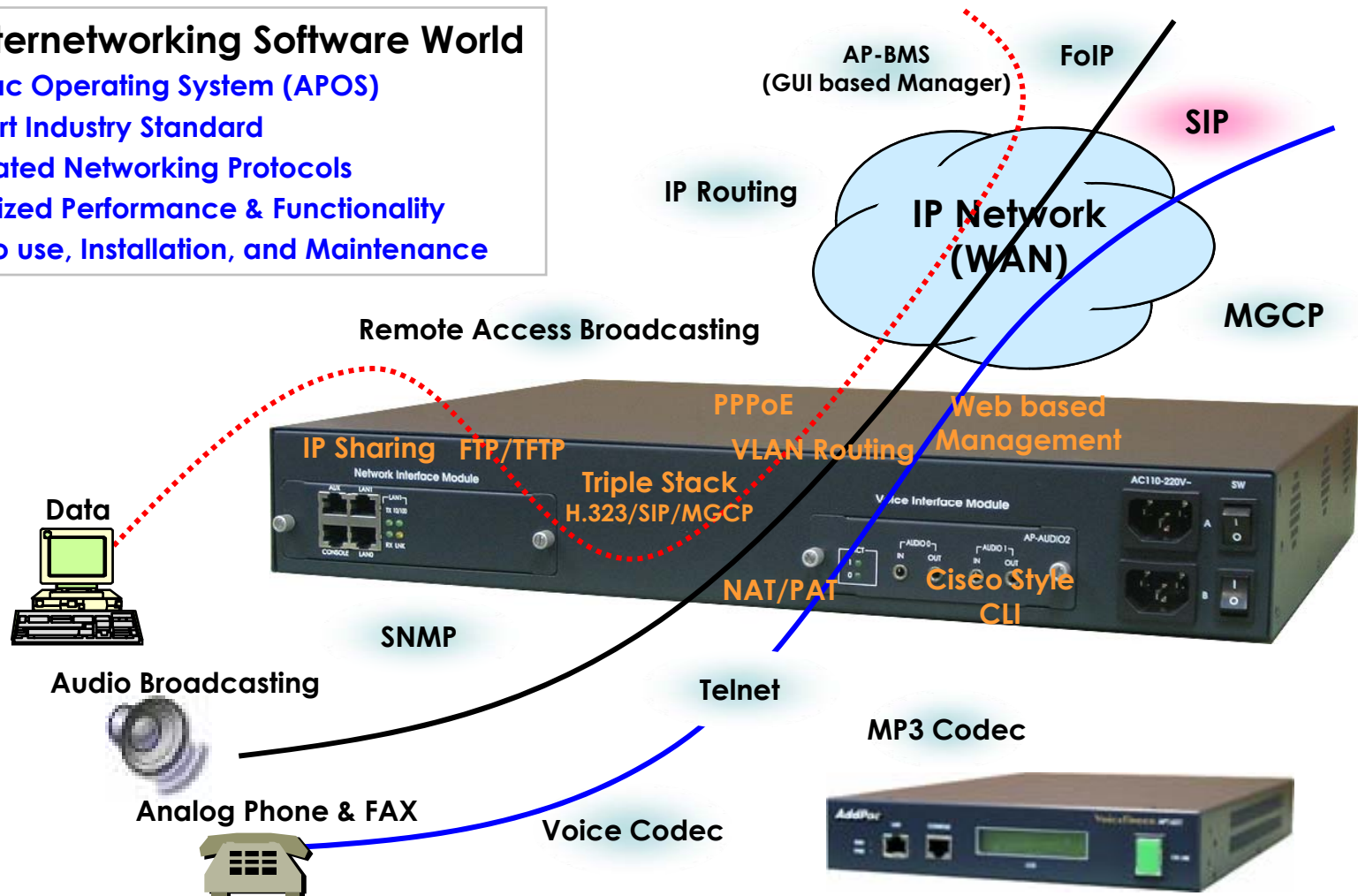

AddPac

www.addpac.com

11

APOS™ for IP Audio Broadcasting Server

IP and WAN Protocols

- IP Routing Protocols

- Multi-protocol Internetworking Services
- Static & Default IP routing
- RIP v1/v2 (opt.)
- OSPF v2 routing protocols support (opt.)
- Transparent Bridging (IEEE Spanning Tree Protocol)

- WAN Protocols

- Point-to-Point Protocol (PPPoE for ADSL)
- IEEE 802.3 Ethernet
- PPTP support for secure communication

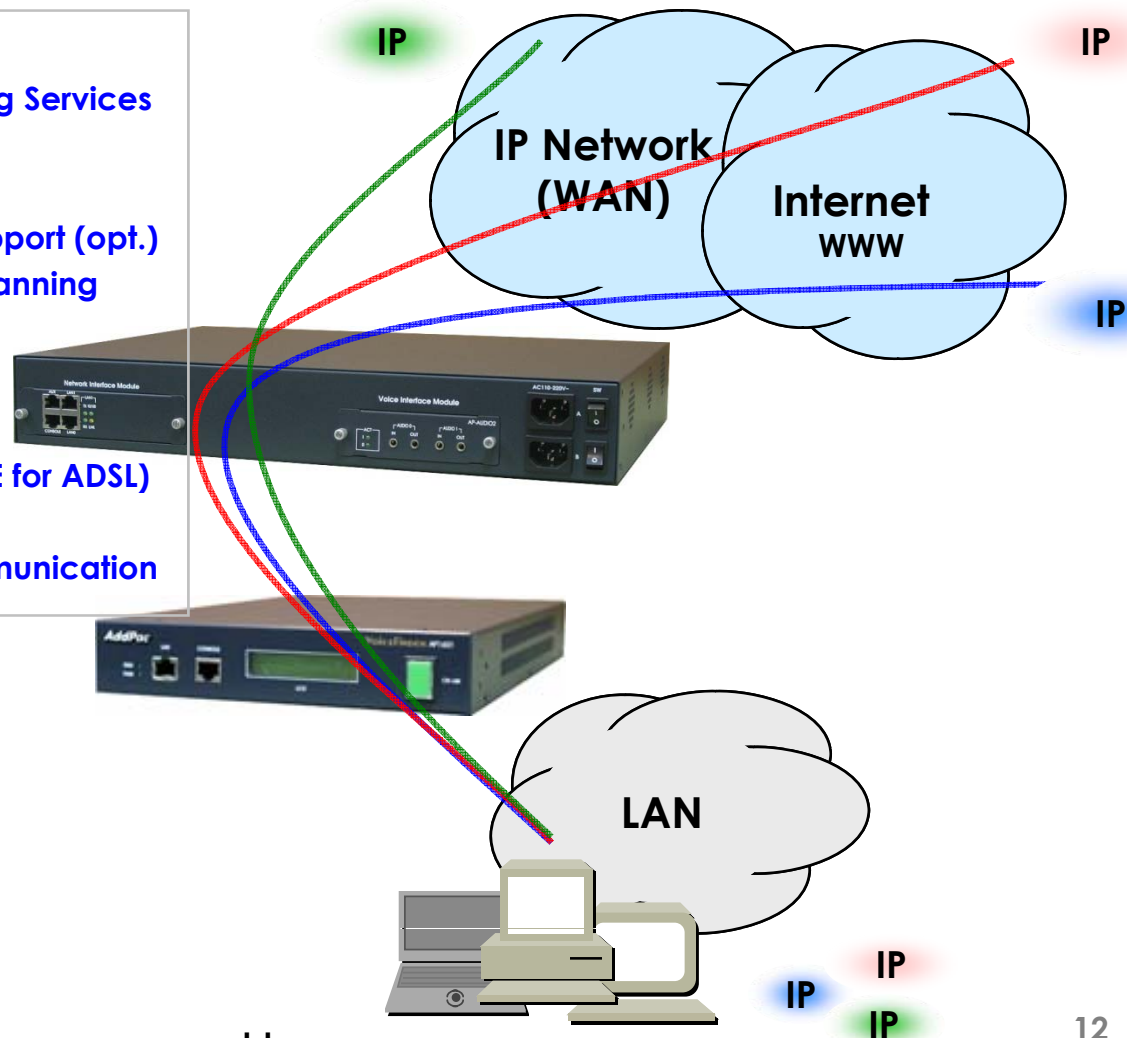

APOS™ for IP Audio Broadcasting Server

IP Broadcasting Services Including VoIP (1)

- Voice Codec for AP-AUDIO2 Module

- G.711 A-Law, G.711 U-Law
- G.726 r16, G.726 r32
- G.729A
- G.723.1 r63, G.723.1 r53
- VAD (Voice Activity Detection) function support
- DTMF relay support (H.323, SIP) based on RFC2833

- Audio Codec for AP-MP3 Module

- MP3(MPEG2 Layer3) Audio Codec
- VAD (Voice Activity Detection) function support
- DTMF relay support (H.323, SIP) based on RFC2833

- RTP

- Redundant RTP packet transmission in case of severe packet loss
- Dynamic jitter buffer management and RTP packet jitter and loss compensation with heuristic & DSP error concealment
- Static jitter buffer setting support
- Voice frame per RTP packet number control for each codec
- In-band ring-back tone support
- Virtual ring-back tone support
- Tone parameter change support

VoIP



APOS™ for IP Audio Broadcasting Server

IP Broadcasting Services Including VoIP (2)

- H.323
 - ITU-T Standard H.323 v3 Support
 - Support H.245 Tunneling
 - Including H.235 Security Features
- SIP
 - IETF RFC3261 or RFC2543 SIP Standard

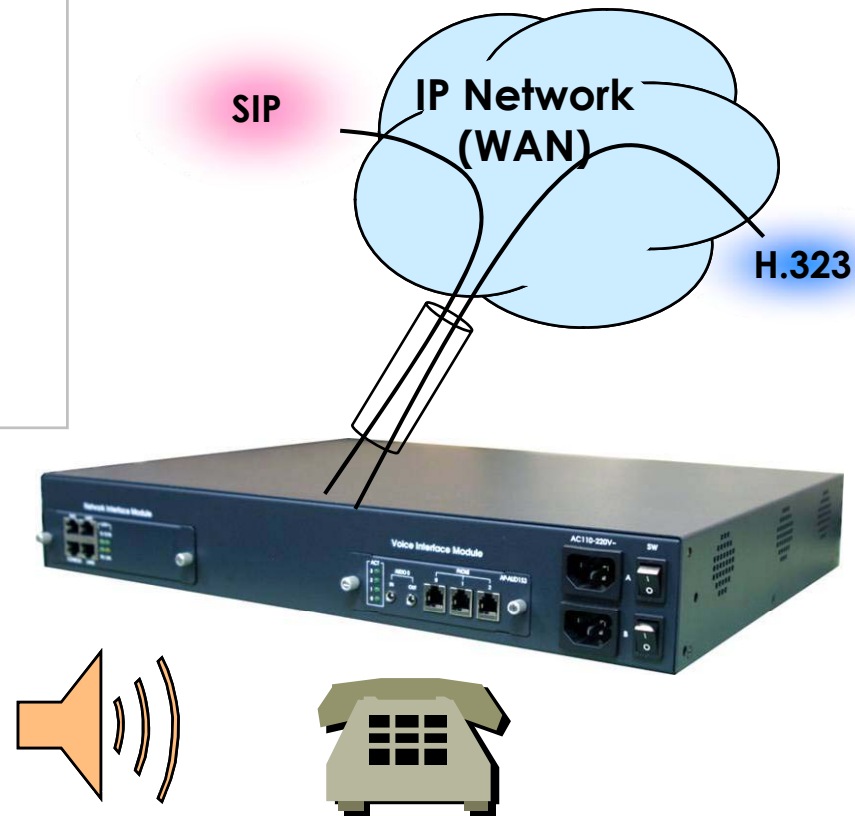

APOS™ for IP Audio Broadcasting Server

IP Broadcasting Services Including VoIP (3)

• H.323

- Fast connect, normal connect support
- H.245 tunneling support
- Q.931 response message setting for inbound VoIP calls
- H.245 logical channel open timing selection function
- Start H.245 procedure support
- DTMF / Hook flash relay with H.245 alphanumeric / signal
- Secondary gatekeeper support
- Gatekeeper assignment according to the domain name
- Gatekeeper discovery with multicast
- Lightweight RRQ support
- Signaling TCP port assignment
- Resource threshold setting with RAI
- H.235 clear-token, crypto-token support
- Can Map Alias support
- Technical prefix (supported prefix) support
- Public IP assignment in NAT environment



• SIP

- Gateway-based / Endpoint-based registration support
- Secondary proxy-server assignment function
- SIP signaling port change function
- SIP proxy server assignment according to the domain name
- T.38 real-time fax relay support
- DTMF relay support with RFC2833 / OPTION message
- Re-INVITE support

APOS™ for IP Audio Broadcasting Server

IP Broadcasting Services Including VoIP (4)

• VoIP Call Controls

- Hot line connection function with PLAR (Private Line Auto Ring Down)
- Leased line emulation function
- Connection monitoring function
- Fault tolerant with Redundancy and Call Distribution among Gateways for load balancing
- Call attempt with IP address
- H.323, SIP inbound call connection for each voice port
- Multiple E.164 setting for one voice port
- One E.164 or digit pattern can be assigned to more than one voice port
- Hunting with Longest match/ priority/ sequence/ random
- One stage call setup by Digit forwarding
- Call barring with specific digit patterns
- Calling and called number conversion for PSTN outbound calls
- PSTN rerouting in case of VoIP call attempt failure

• VoIP Call Controls (cont.)

- Call transfer for internal calls
- Call pickup for internal calls
- Calling and called number conversion for VoIP outbound calls
- Calling and called number conversion for VoIP inbound calls
- Fax broadcasting call control

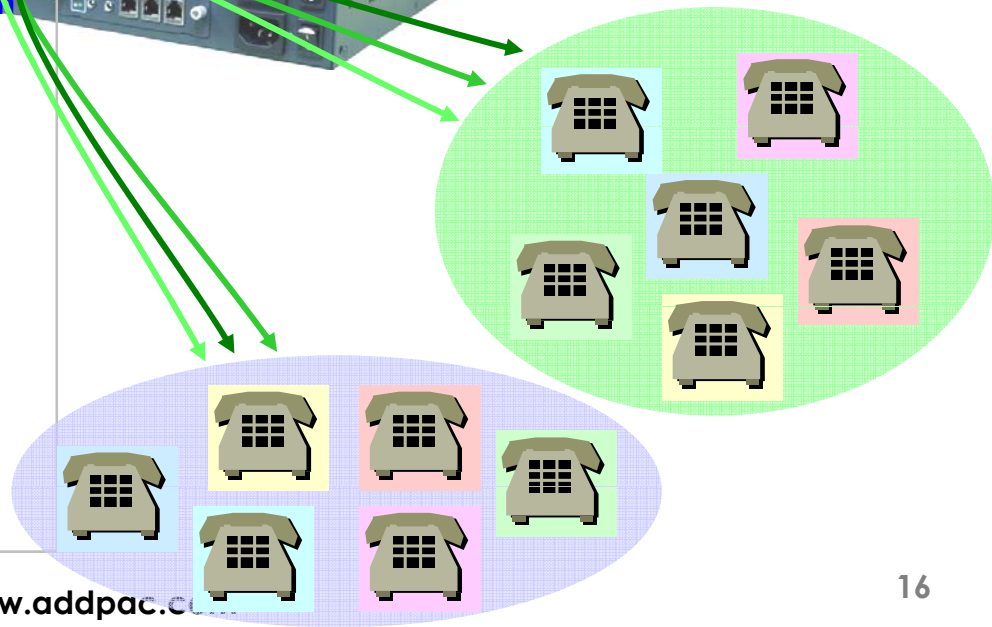

APOS™ for IP Audio Broadcasting Server

Unicast & Multicast Service

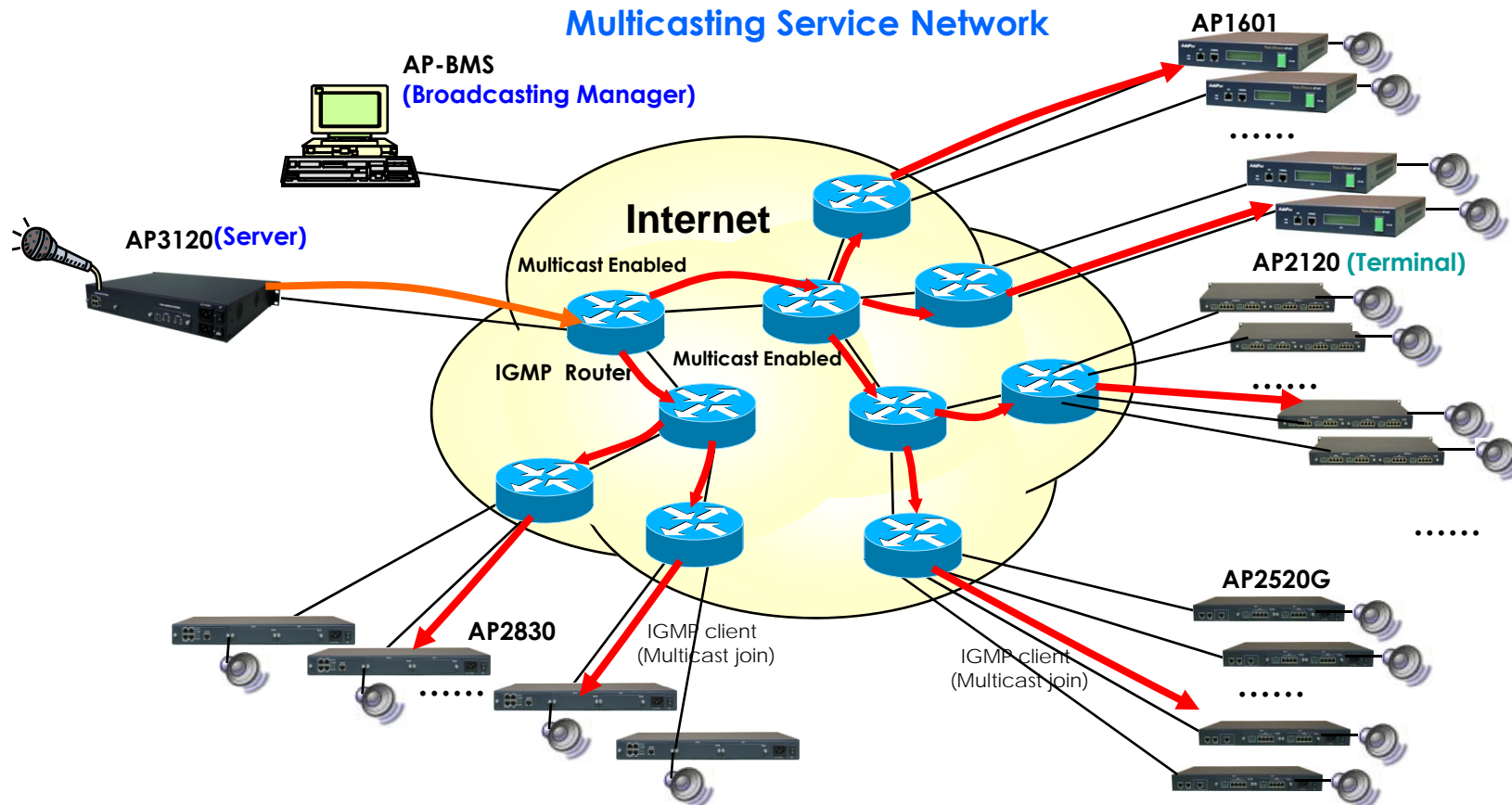

- Multicast protocol based such as **IGMP Protocol**
- Available to broadcast multi destination with single channel bandwidth

APOS™ for IP Audio Broadcasting Server

Unicast & Multicast Service

Unicasting Service Network

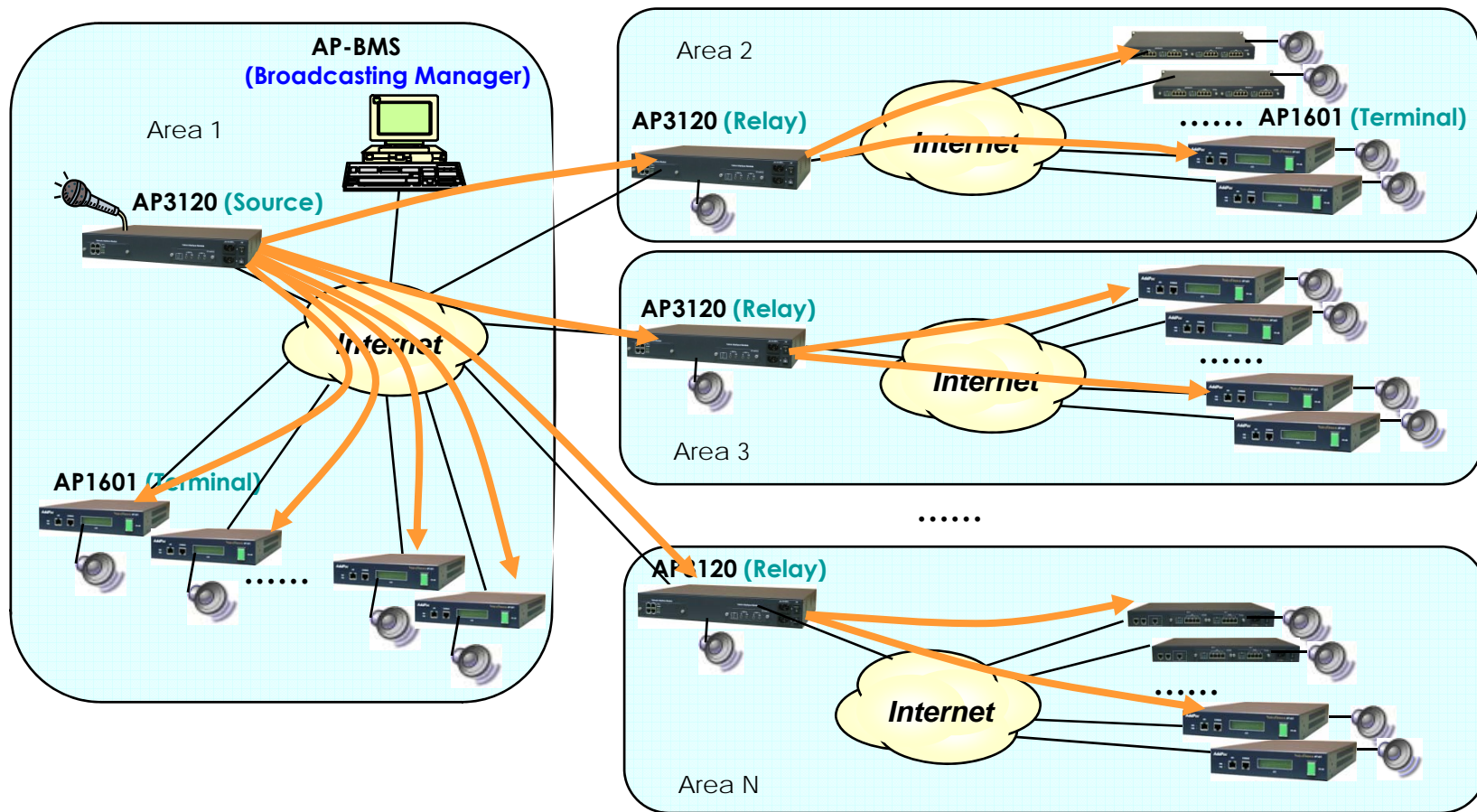

APOST™ for IP Audio Broadcasting Server

Enhances QoS Managements(1)

- Enhances **Transmit** Voice QoS Features

- Voice Traffic Priority Queuing
- QoS Service Profiling
- Providing Virtual Network Transmit Algorithm
- Real-time Voice Traffic QoS Support
- RTP Packet Transmit Interval Control
- Supporting RTP Packet Redundancy Scheme
- IP Header Control such as ToS, Diffserv

- Enhances **Receive** Voice QoS Features

- Dynamic Jitter Buffer Management
- Error Concealment
- Support T.38 FAX Data Error Recovery Scheme

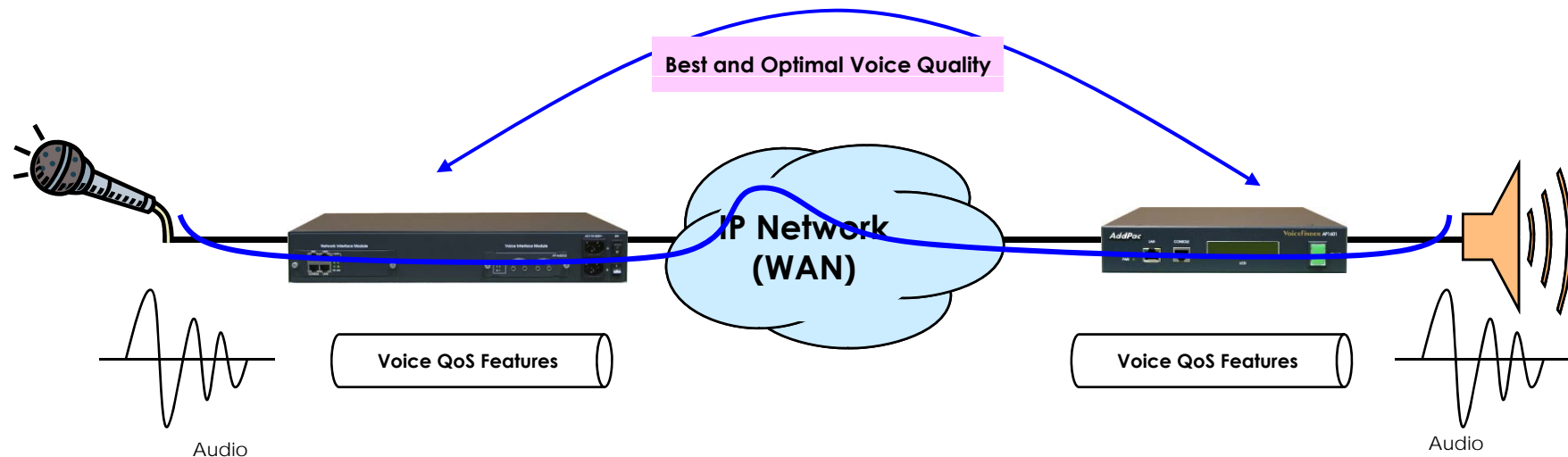

APOS™ for IP Audio Broadcasting Server

Enhances QoS Managements (2)

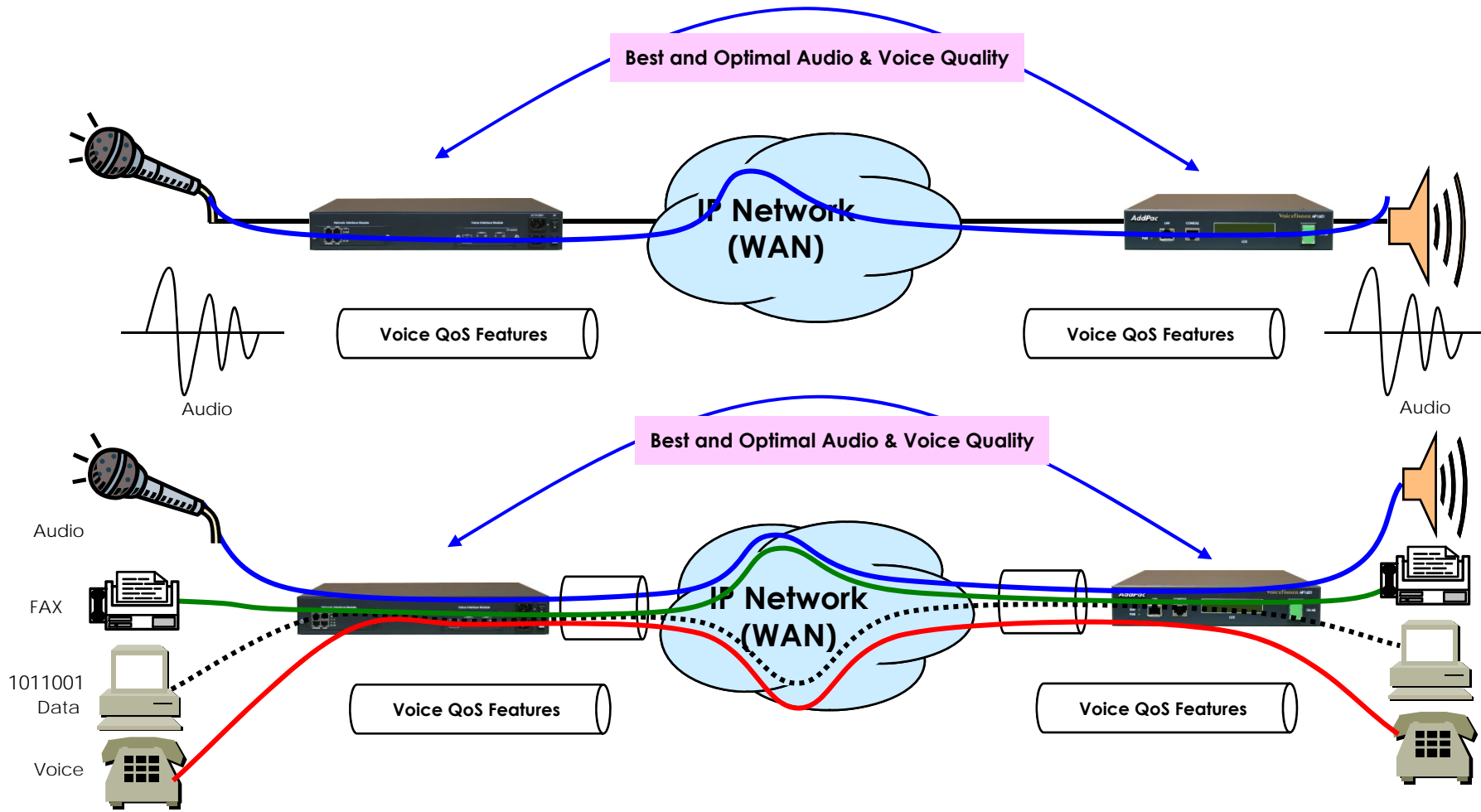

AddPac

www.addpac.com

20

APOS™ for IP Audio Broadcasting Server

Network Managements

- **SNMP**

- Standard Simple Network Management Protocol(SNMP) Agent support
- MIB v1 and v2 Support

- **Web-based Management**

- Standard Voice & Audio Interface

- **Watch-dog Function**

- Hardware, Software watch-dog services

- **Remote Management**

- Telnet
- Rlogin
- Console

- **Auto Upgrade Service**

- HTTP server based APOS image and configuration file auto-upgrade support

- **Batch Job Function**

- Text based script downloading

- **AP-BMS**

- MS Windows Graphical User Interface (GUI) based Audio Broadcasting Management
- Service Group Configuration
- Scheduled Broadcasting
- Status Monitoring
- Report Service
- Embedded Media file Manager

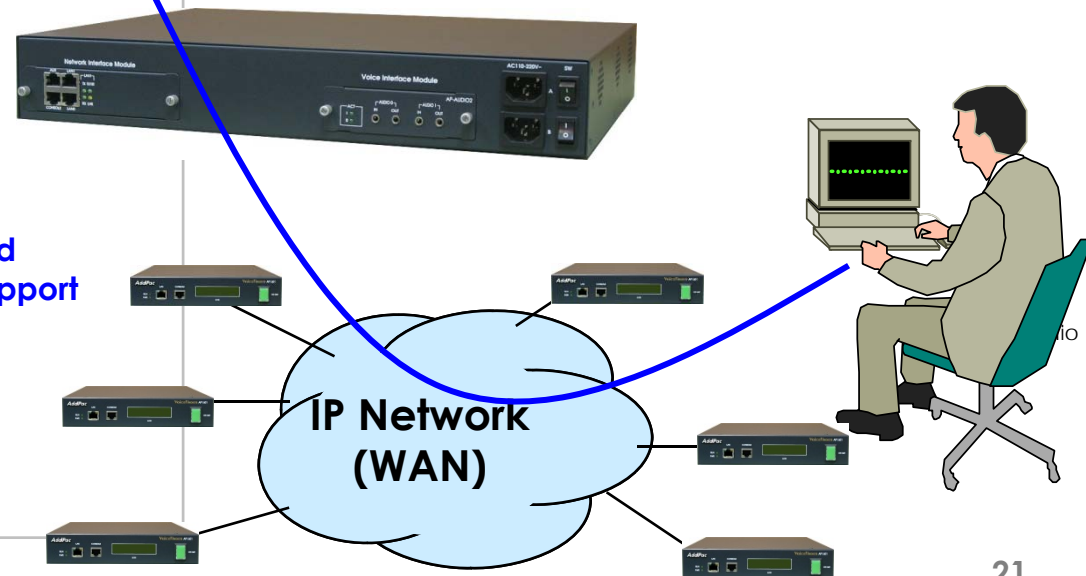

AddPac

www.addpac.com

21

APOS™ for IP Audio Broadcasting Server

Network Scalability (1)

- IP Sharing Feature

- Single IP Address, Multiple IP Network Access
- Public IP Address Sharing by AP3120

- IP Sharing Network Environment

- Support Legacy Network Environment
- xDSL Modem based Broadband Network
- Cable Modem based Broadband Network
- Leased line Network Environment

- Both support Fixed and Dynamic IP

- Support Standard Network Protocols

- PPPoE
- PPPTP
- DHCP

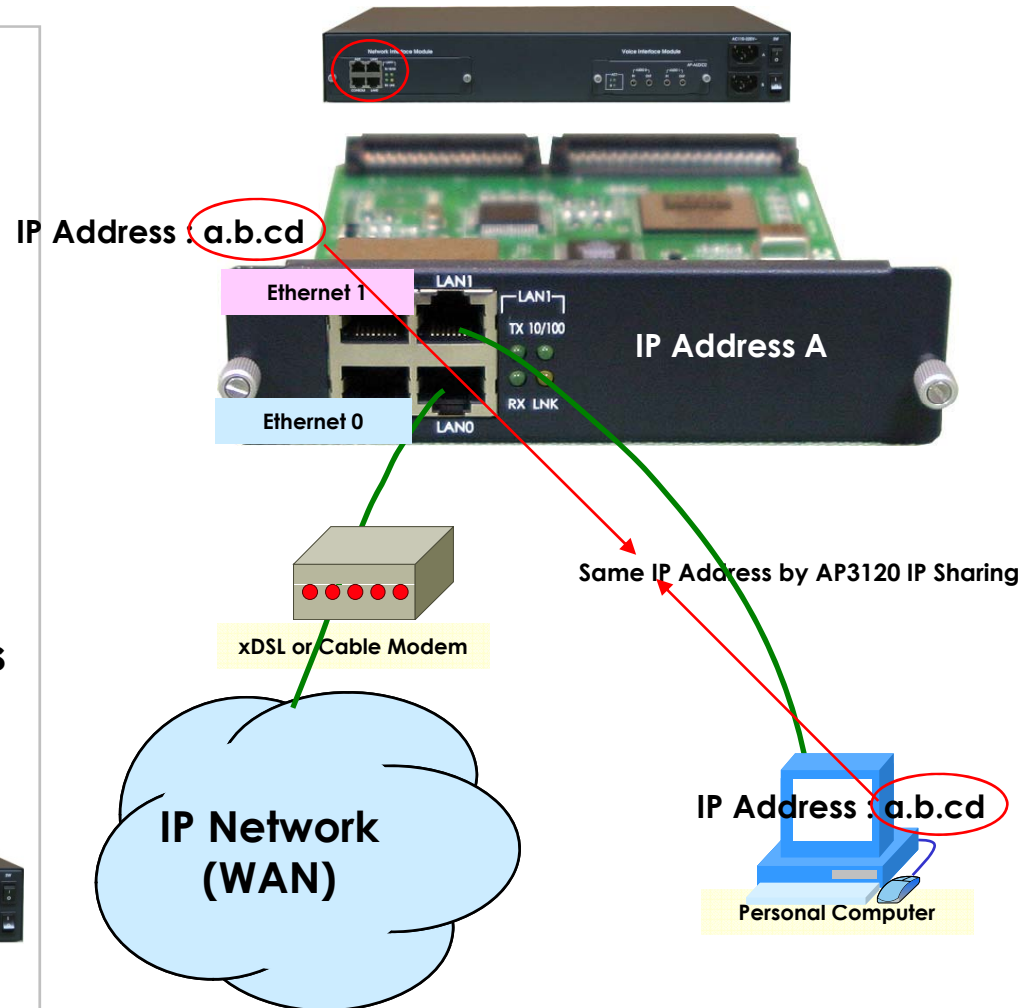

APOS™ for IP Audio Broadcasting Server

Network Scalability (2)

- **Bridging Service**
 - Spanning Tree Bridging protocol (IEEE) support
- **DHCP**
 - Server and Relay
- **IP Accounting**
- **PAT (Port Address Translation)**
- **NAT (Network Address Translation)**
- **Cisco Style CLI (Command Line Interface)**
- **PPTP (Point-to-Point Tunneling Protocol)**
- **NTP (Network Time Protocol)**
- **FTP/TFTP**
 - Server and Client support
- **DNS / DDNS**
 - Dynamic DNS Client support

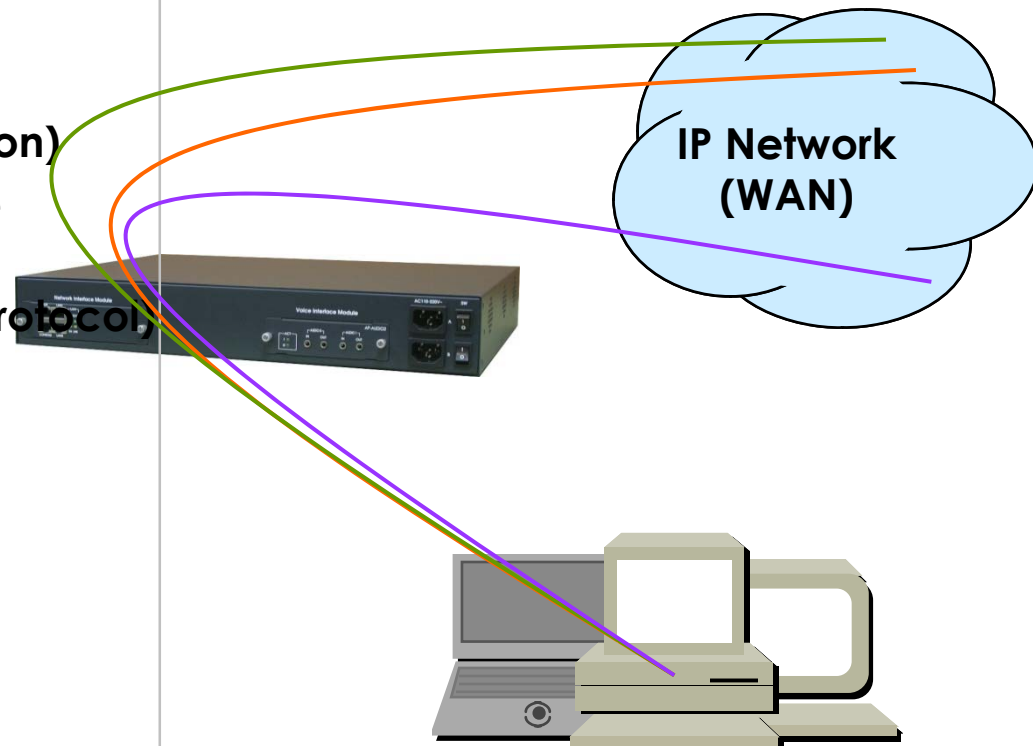

APOS™ for IP Audio Broadcasting Server

Security Managements (1)

- IP packet filtering
- IP access list
- User authentication function
 - PAP / CHAP
- Enable/Disable specific protocols
- Auto-square connect of console and Telnet session
- Account Management function for multi-level user
- SNMP/TELNET/FTP/HTTP/TFTP port assignment function
- SNMP/TELNET/FTP access list management
- Boot mode security checking function
- IVR based Access Control via Phone & Cellular Phone

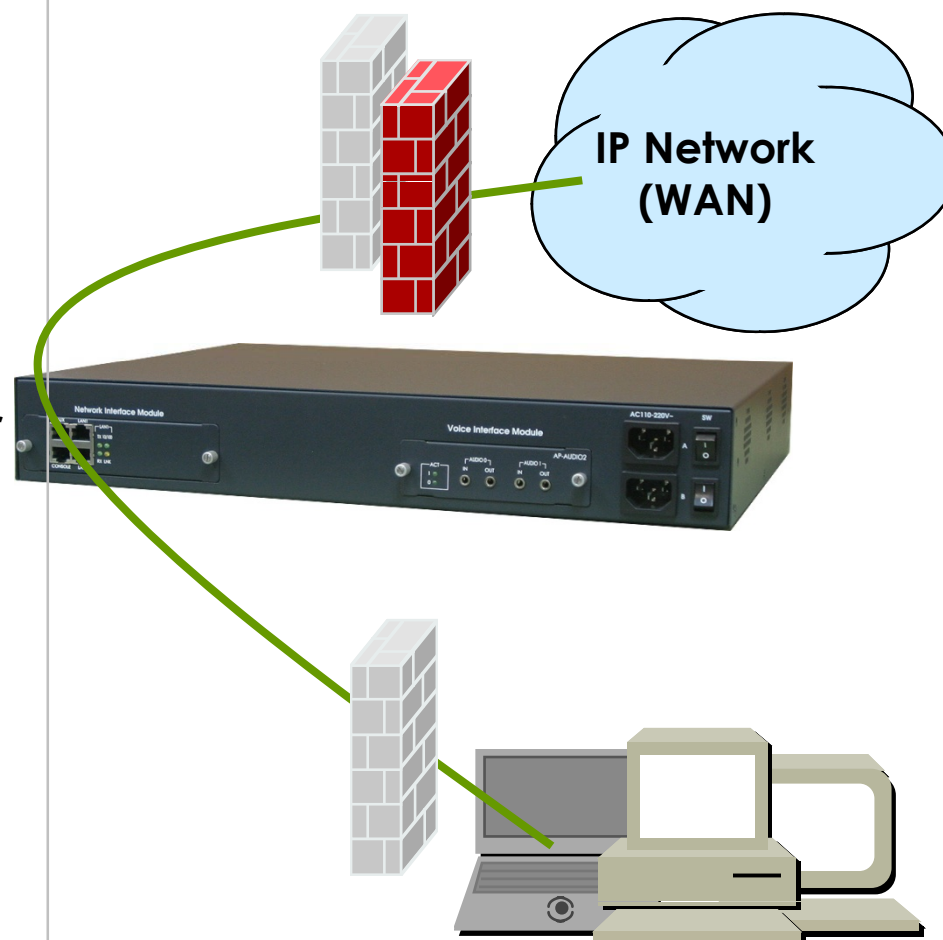

APOS™ for IP Audio Broadcasting Server

Security Managements (2)

- IVR based Access Control via PSTN phone & cellular phone
- Password based Access Control
- Available to select Broadcasting Point

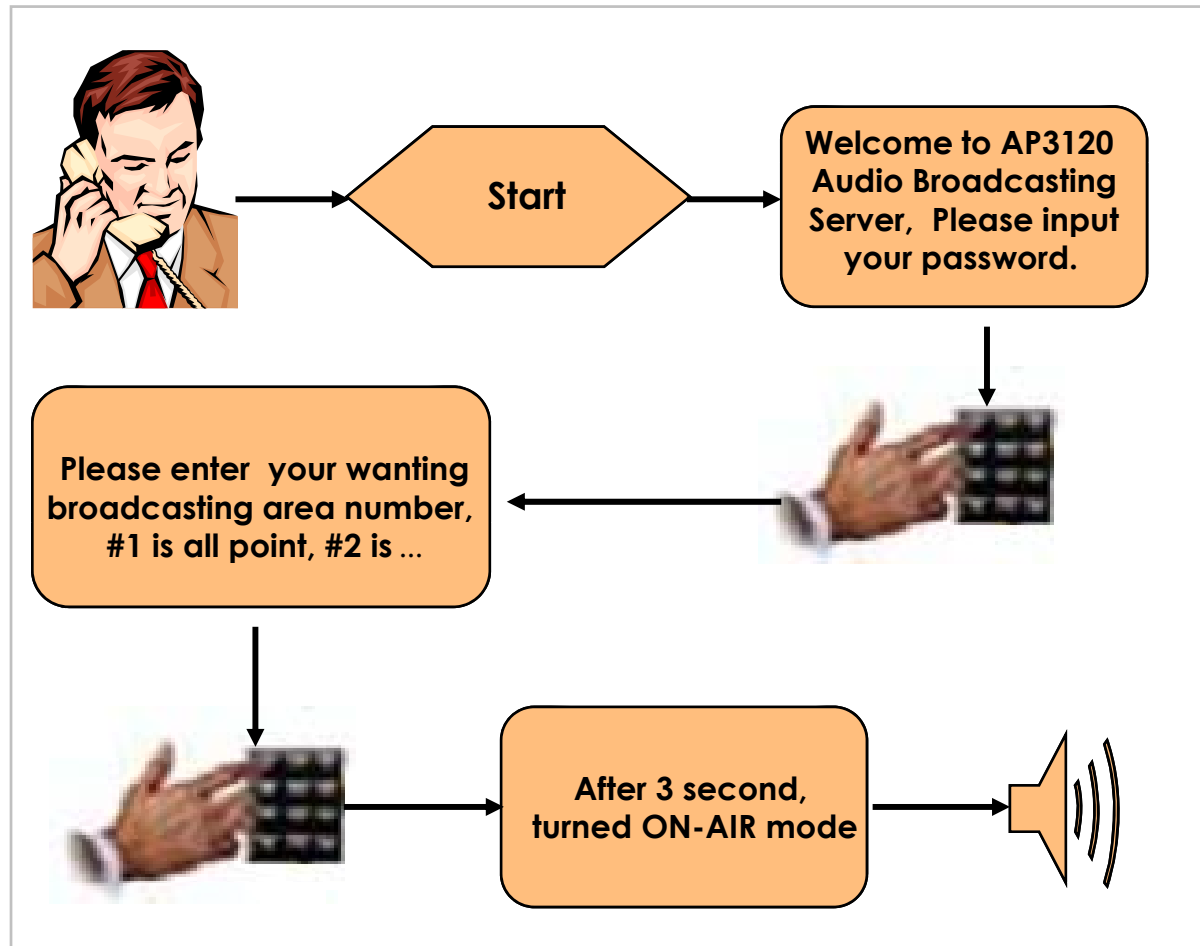

The Vision of Next Generation Audio Broadcasting

AP3120 System Overview



AP3120 System Overview

AP3120 Network Interface (1)

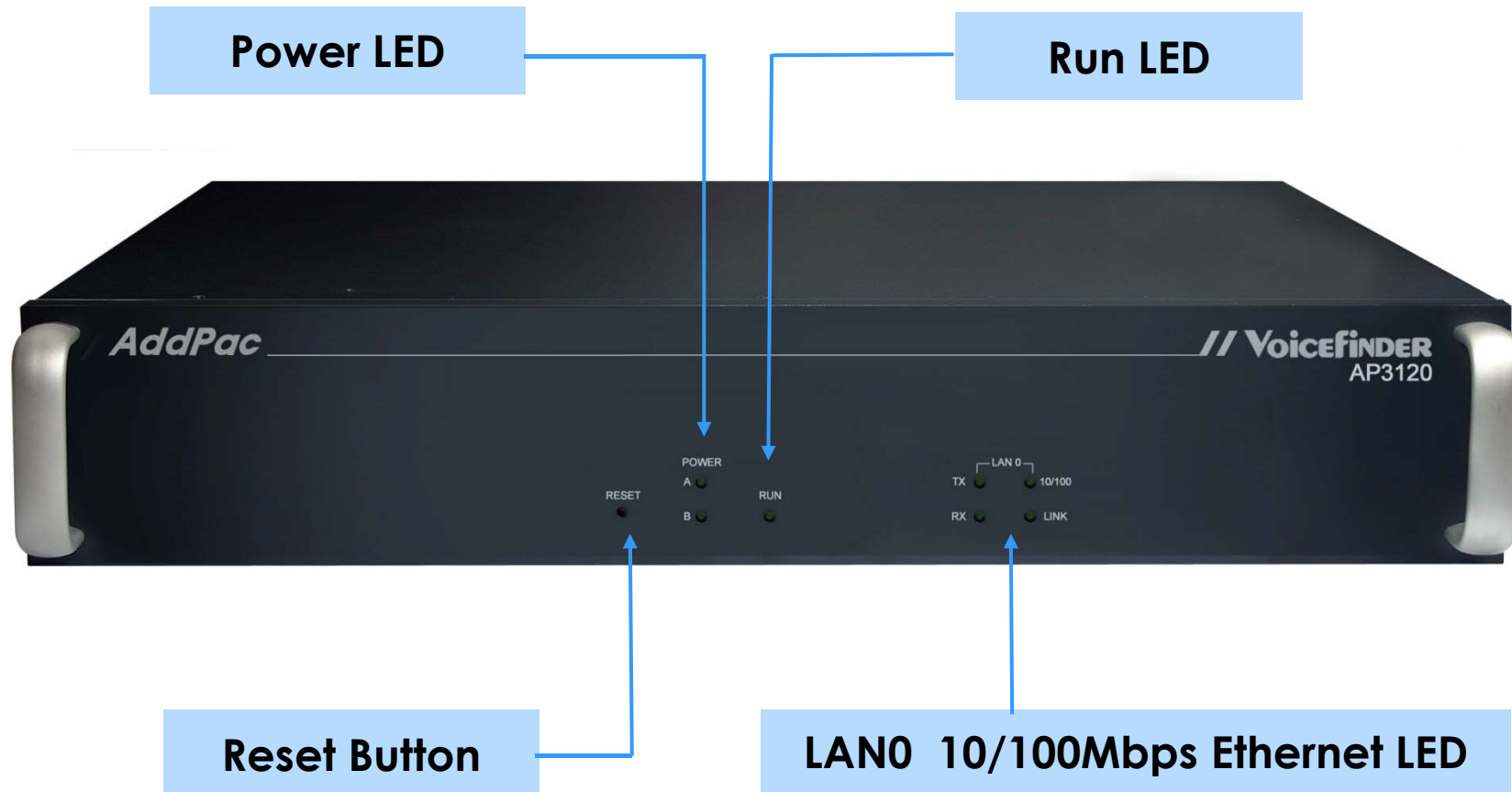

AP3120 System Overview

AP3120 Network Interface (2)

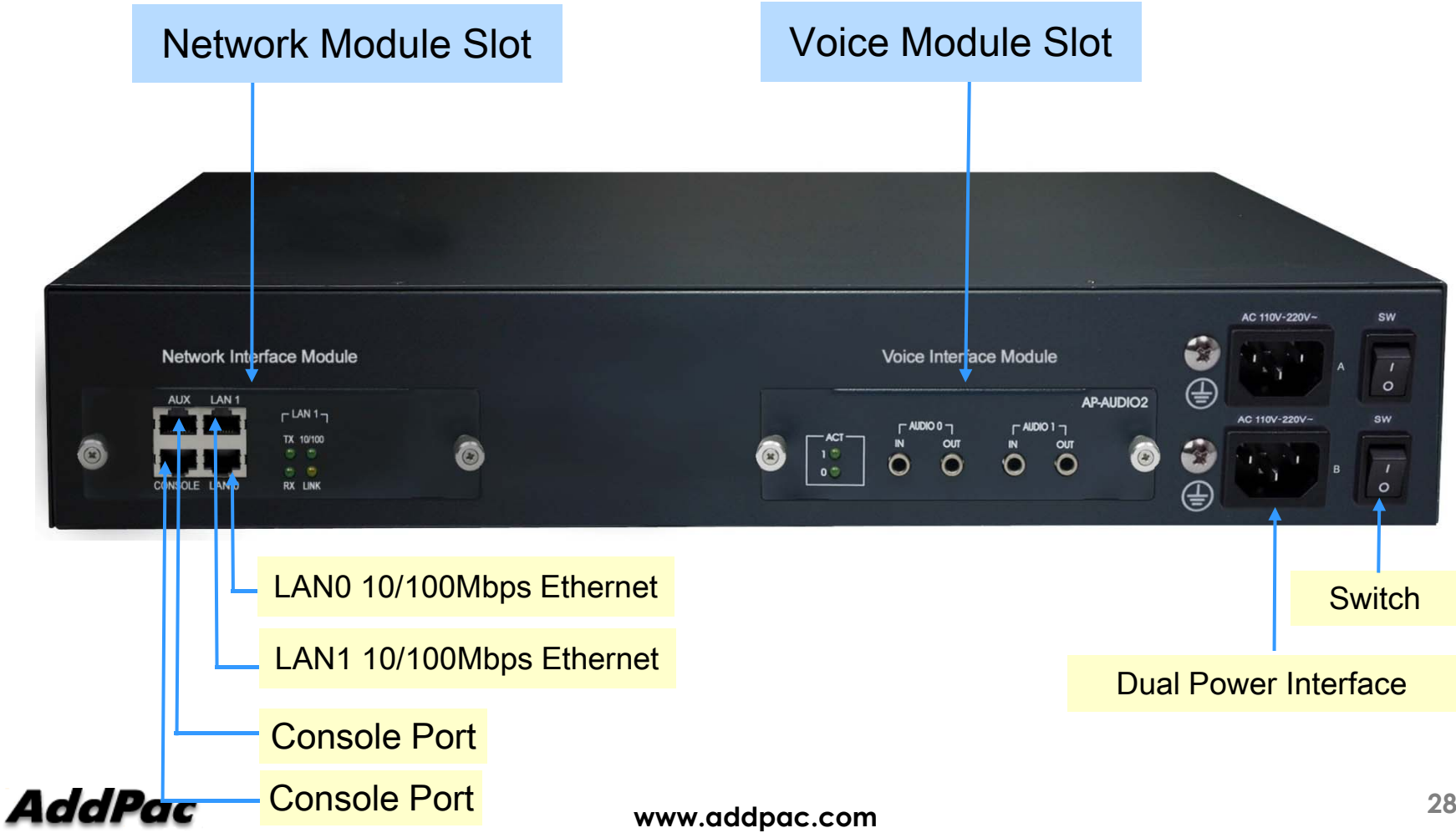

AddPac

www.addpac.com

AP3120 System Overview

AP3120 Analog Interface Module (1)

- ❑ Support Various VoIP Module



AddP

- 2-Pair Audio-In/Out Ports
- Voice Band IP Broadcasting

- 1-Pair Audio-In/Out Ports, FXS Analog Interface
- Voice Band IP Broadcasting

- 1-Pair Audio-In/Out Ports, FXS 2-Ports, FXO 1-Port
- Voice Band IP Broadcasting

www.addpac.com

29

AP3120 System Overview

AP3120 Analog Interface Module (2)

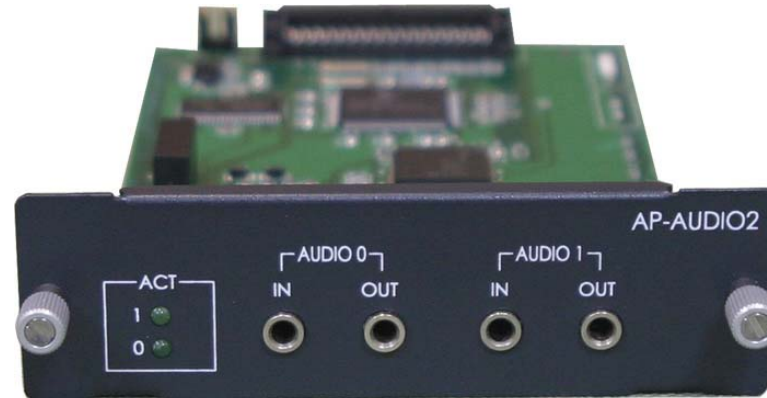

AP-AUDIO2



AP-AUD1S3



AP-AUD1S201

AP3120 System Overview

Analog Interface Module Connectivity (1)

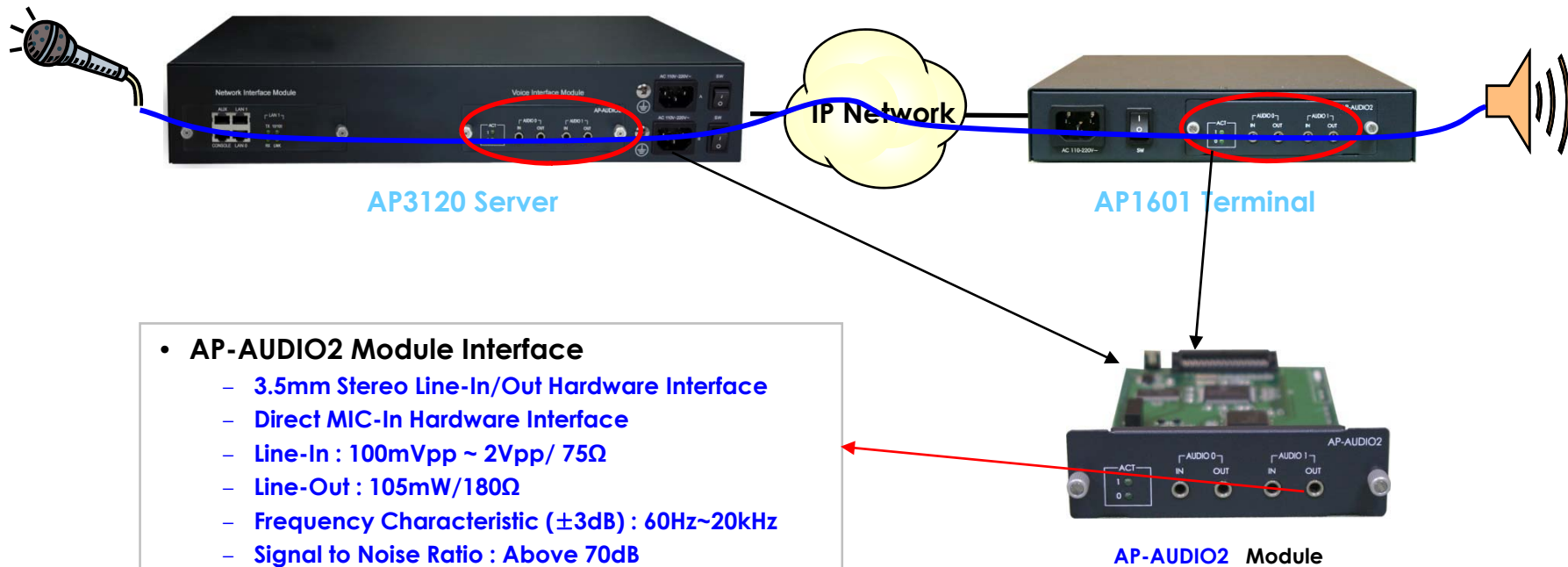

AP3120 System Overview

Analog Interface Module Connectivity (2)

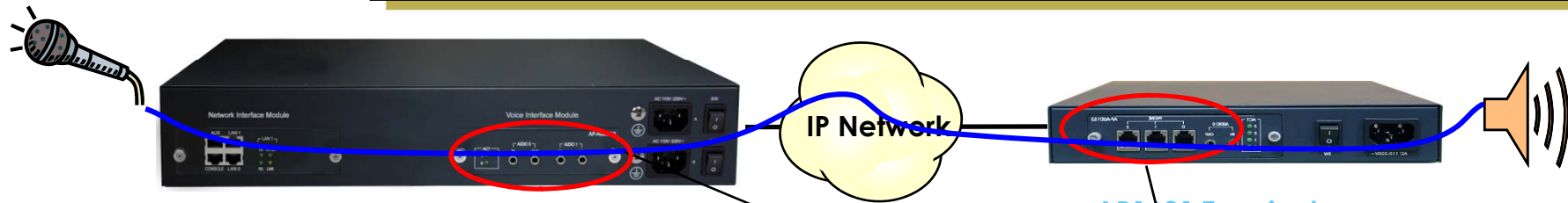

AP3120 Server

AP1&01 Terminal

- **AP-AUD1S2O1 Module (AUD1 Interface)**
 - 3.5mm Stereo Line-In/Out Hardware Interface
 - Line-In : 100mVpp ~ 2Vpp/ 75Ω
 - Line-Out : 105mW/180Ω
 - Frequency Characteristic (±3dB) : 60Hz~20kHz
 - Signal to Noise Ratio : Above 70dB
- **AP-AUD1S2O1 Module (2FXS Port Interface)**
 - RJ-11 Hardware interface
 - Polarity inverse generation function
 - Caller-id generation function
 - Busy-out function support
 - Ring cadence setting function
 - Ring frequency setting function
 - European type II telephone support
 - Surge protect support

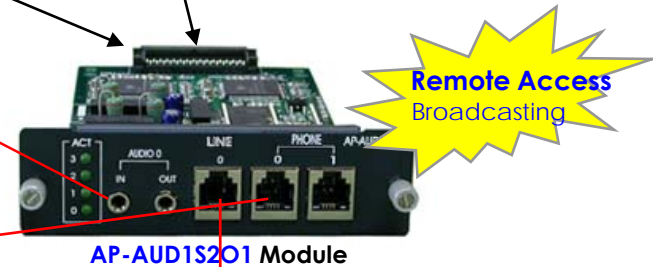

AP-AUD1S2O1 Module

AP-AUD1S2O1 Module (1FXO Port Interface)

- Polarity inverse detection function
- Caller-ID detection function
- Busy-out function support
- Clear down tone registration and detect function
- Hook flash timing setting function
- Ring detect timeout setting function
- Ring number setting function
- RJ-11 Hardware interface

AP3120 Overview

Analog Interface Module Connectivity (3)

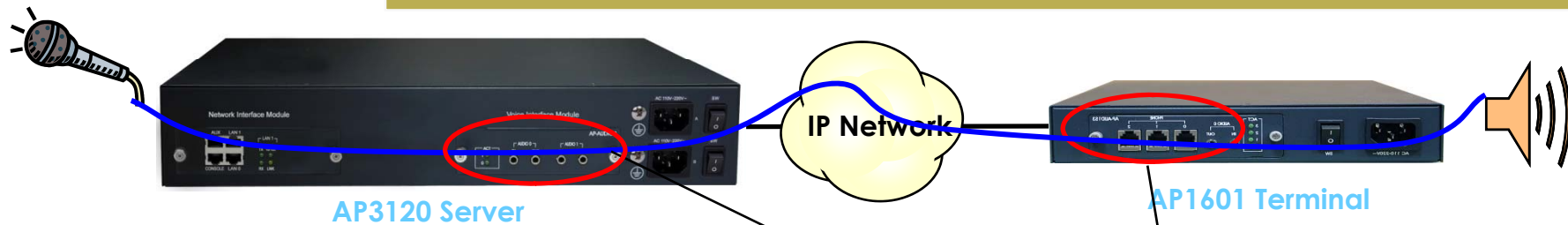

- **AP-AUD1S3 Module (AUD1 Interface)**
 - 3.5mm Stereo Line-In/Out Hardware Interface
 - Line-In : 100mVpp ~ 2Vpp/ 75Ω
 - Line-Out : 105mW/180Ω
 - Frequency Characteristic ($\pm 3\text{dB}$) : 60Hz~20kHz
 - Signal to Noise Ratio : Above 70dB
- **AP-AUD1S3 Module (3FXS Port Interface)**
 - RJ-11 Hardware interface
 - Polarity inverse generation function
 - Caller-id generation function
 - Busy-out function support
 - Ring cadence setting function
 - Ring frequency setting function
 - European type II telephone support
 - Surge protect support

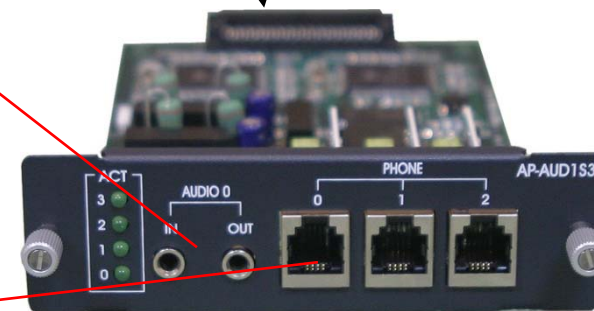

AP-AUD1S3 Module

AP3120 System Overview

AP3120 Client Side Terminal Series

- AP1601 Terminal



- AP2110 VoIP Gateway



- AP2520 VoIP Gateway



- AP2830 ATM Multi Service



- AP2850 ATM Multi Service



AP-Audio2



AP-AUD1S3



AP-AUD1S2O1

AddPac

www.addpac.com

AP3120 System Overview

Server-AP1601 Terminal Matching

AP3120 Broadcasting Server



AP1601 Broadcasting Terminal

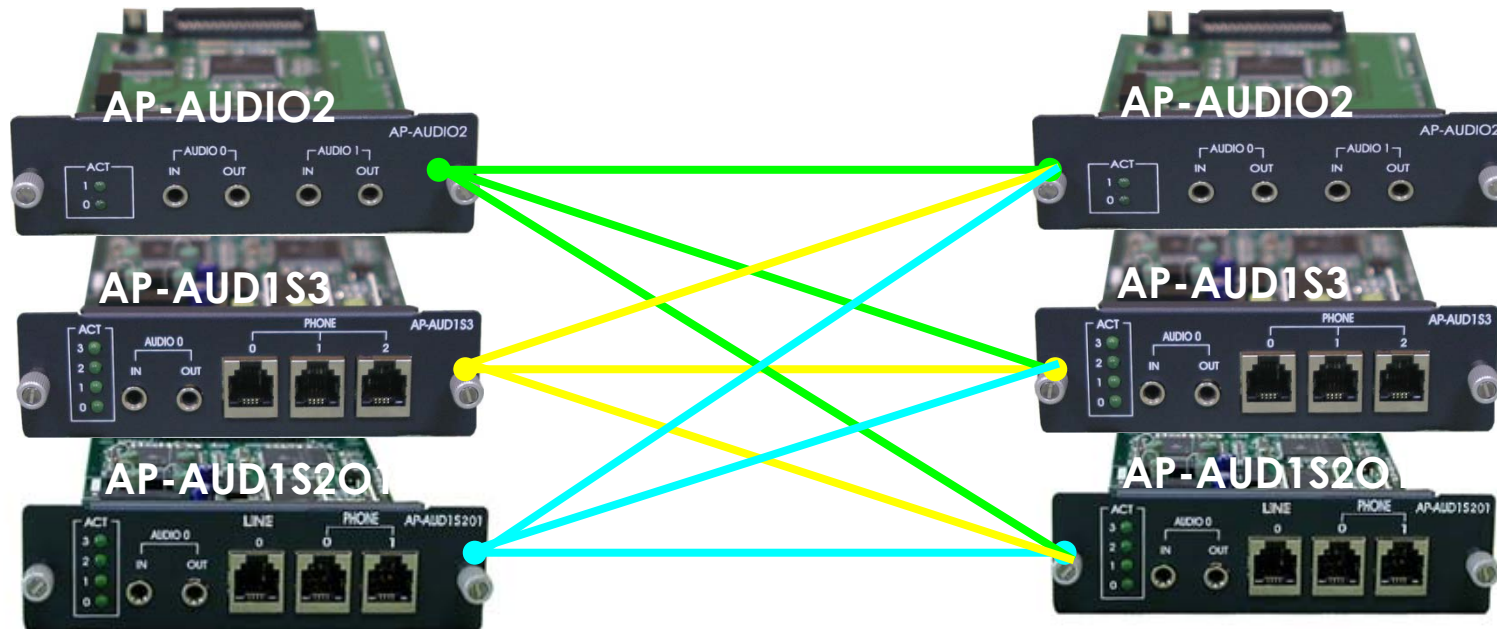

Add

www.addpac.com

The Vision of Next Generation Audio Broadcasting

AP3120 System Configuration



AP3120 System Configuration

AP-AUDIO2 Module Configuration

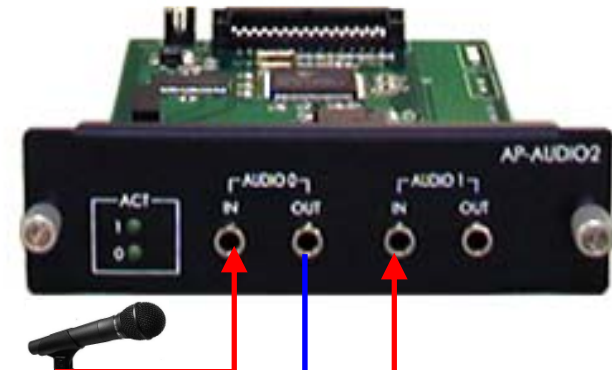
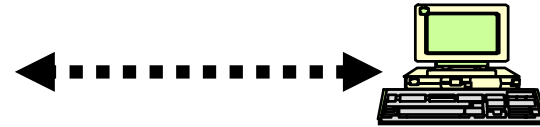
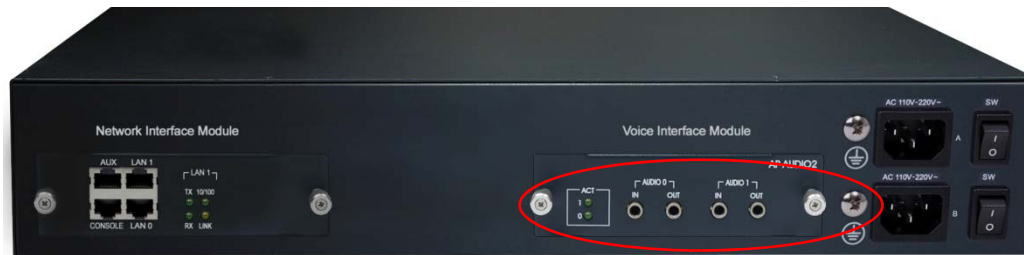

Direct Mic-In

Connect with 1:2 Stereo Jack

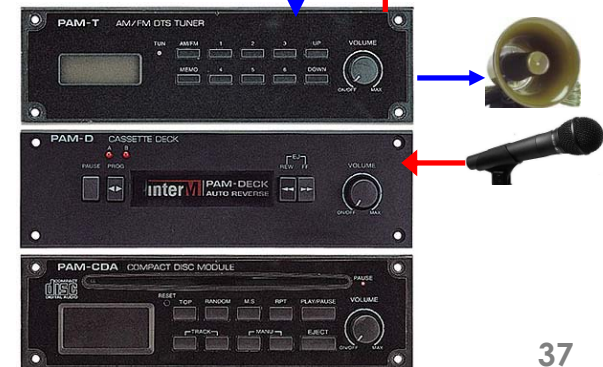

Audio Module HW Specification

Line-In	100mVpp ~ 2Vpp/ 75Ω
Line-Out	105mW/180Ω
Frequency Characteristic (±3dB)	60Hz~20kHz
Signal to Noise Ratio	Above 70dB
Dimension (WHD)	111×32×160mm

AddPac

www.addpac.com

AP3120 System Configuration

AP-AUDIO2 Network

- 2-Pair Audio-In/Out Ports
- 3.5mm Female Analog Interface
- Available to receive & send 2-Channels Broadcasting
- Support Voice Level IP Audio Broadcasting
- Sampling Rate: 8Khz

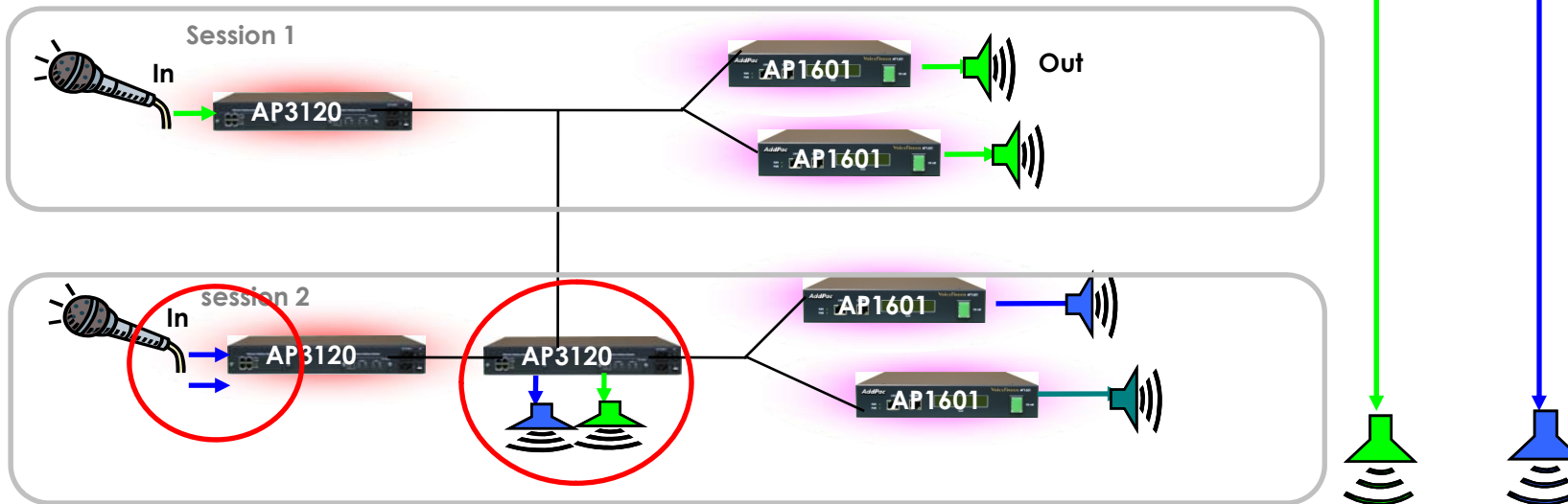

AP3120 System Configuration

AP-AUD1S3 Module Configuration

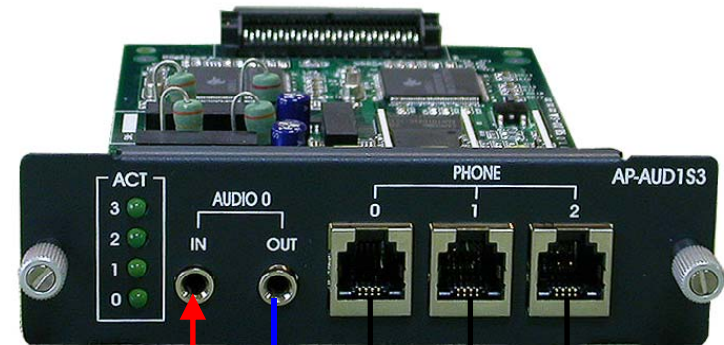

- 1-Pair Analog Audio-In/Out
- 3.5mm Female Stereo Audio Ports
- 3-Ports FXS Analog Interface for VoIP Services
- Realized Integrated Multi Terminal Service
- Support Audio Broadcasting and FAX Broadcasting including VoIP Services

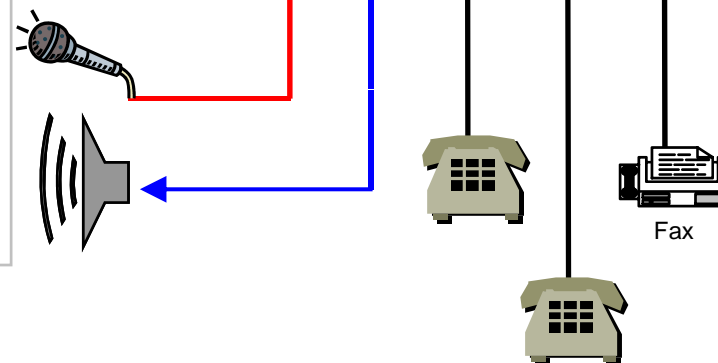

AP3120 System Configuration

AP-AUD1S3 Network Configuration

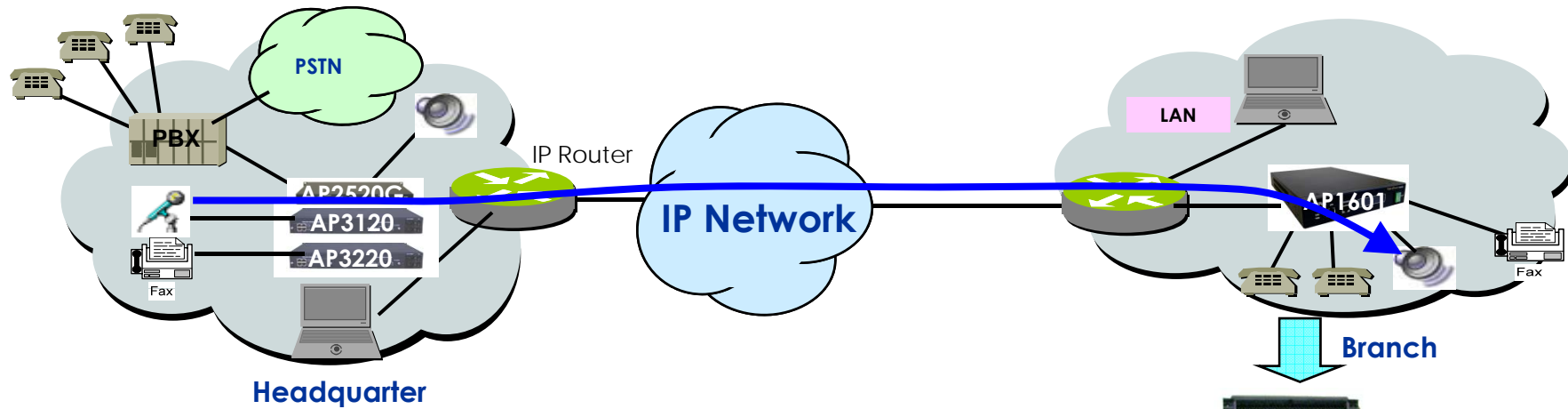

Connect with 1:2 Stereo Jack

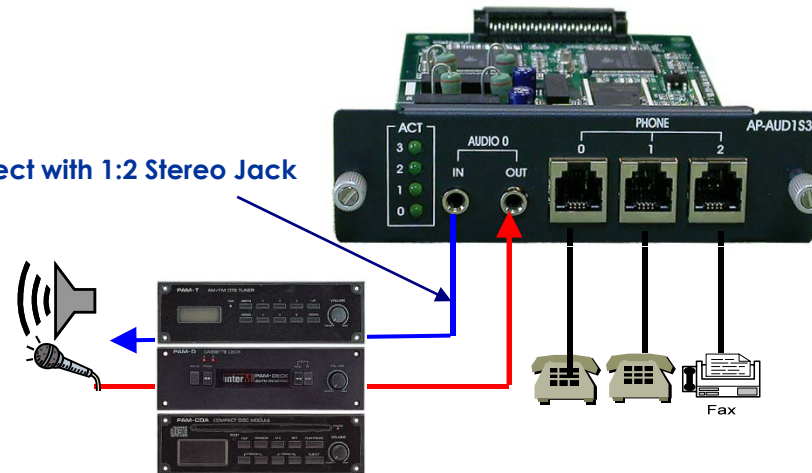

AP3120 System Configuration

AP-AUD1S2O1 Module Configuration



AddPac

www.addpac.com

AP3120 System Configuration

AP-AUD1S2O1 Network Configuration

- Remote Access Broadcasting
 - AP-AUD1S2O1 Module based AP3120
 - Via Analog Phone and Cellular Phone
 - Access Control with IVR Function
 - Cellular Phone → FXO Port → Audio Streaming
 - Available Direct Connect to Terminal (AP1601...)
 - Support Broadcasting and VoIP Services Concurrently

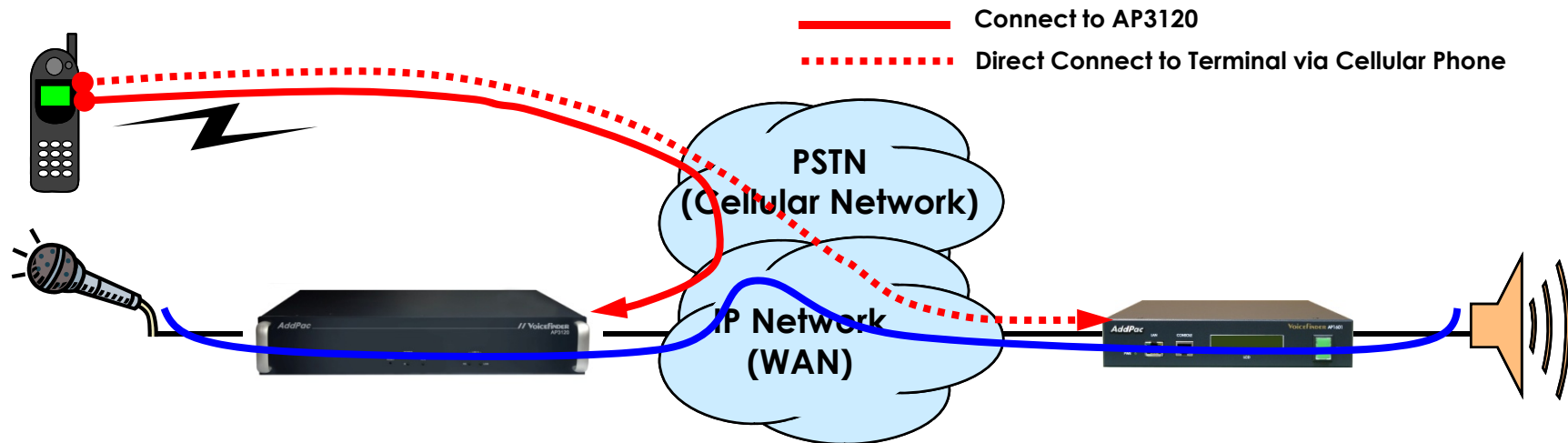

AP3120 IP Audio Broadcasting System Network

AP-AUD1S2O1 based Network

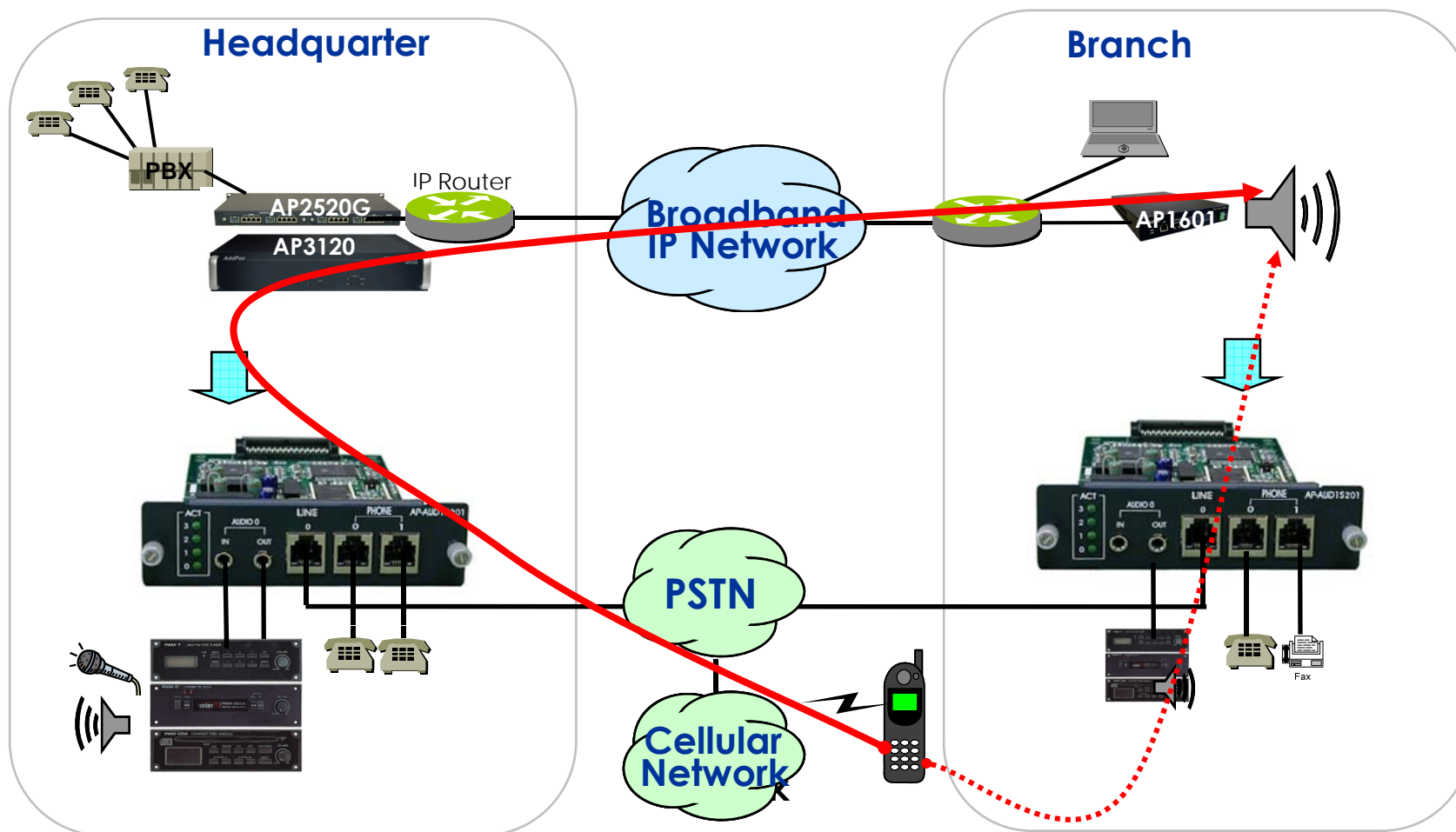

The Vision of Next Generation Audio Broadcasting

AP3120 Management Scheme



AP3120 Management Scheme

Broadcasting Management System (BMS)

- **AP-BMS**

- MS Windows Graphical User Interface (GUI) based Audio Broadcasting Management
- Service Group Configuration
- Scheduled Broadcasting
- Status Monitoring
- Report Service
- Embedded Media file Manager

- **Requirements Hardware Platform**

- Over 1GHz Intel Pentium 4 Machine
- Over 1GB Main Memory
- Over 40GB Hard Disk Memory
- Microsoft Windows Advanced Server or Windows 2000 Server or Windows XP Professional

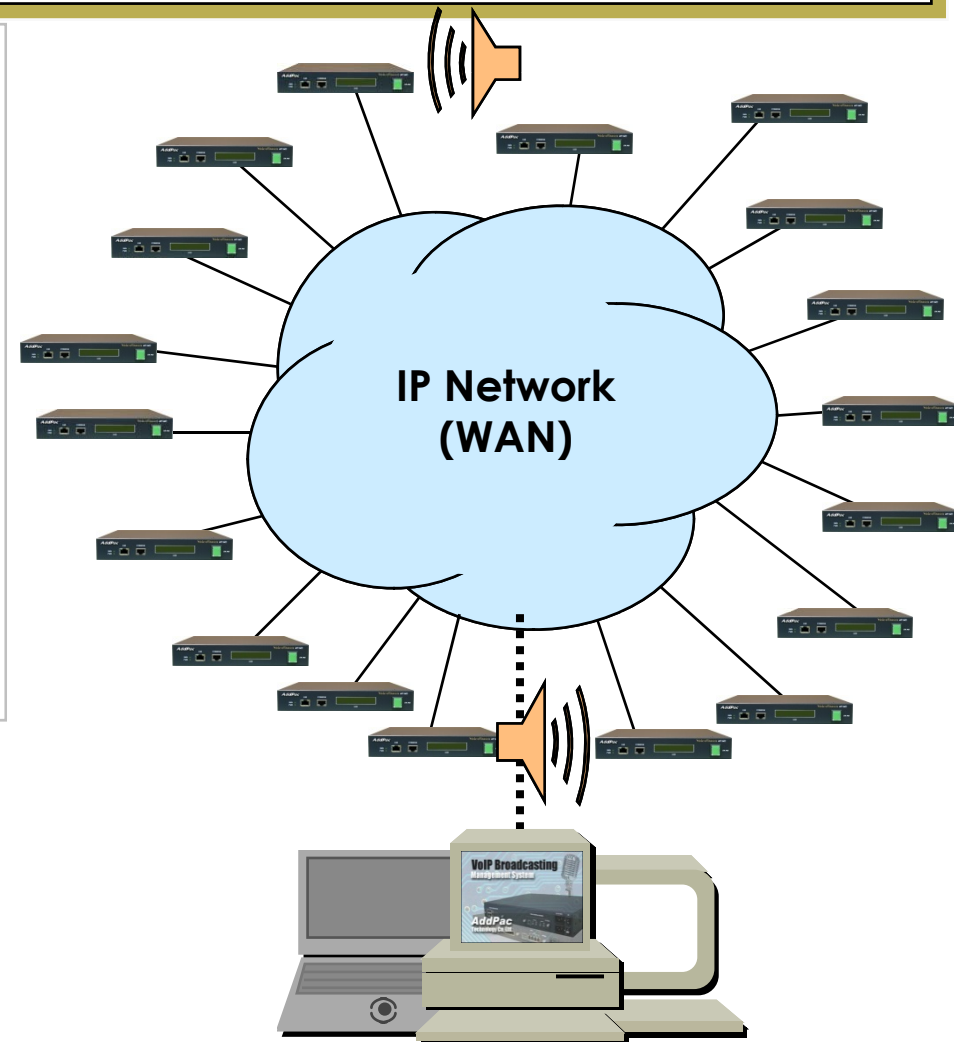

AddPac

www.addpac.com

AP3120 Management Scheme

Broadcasting Management System (2)

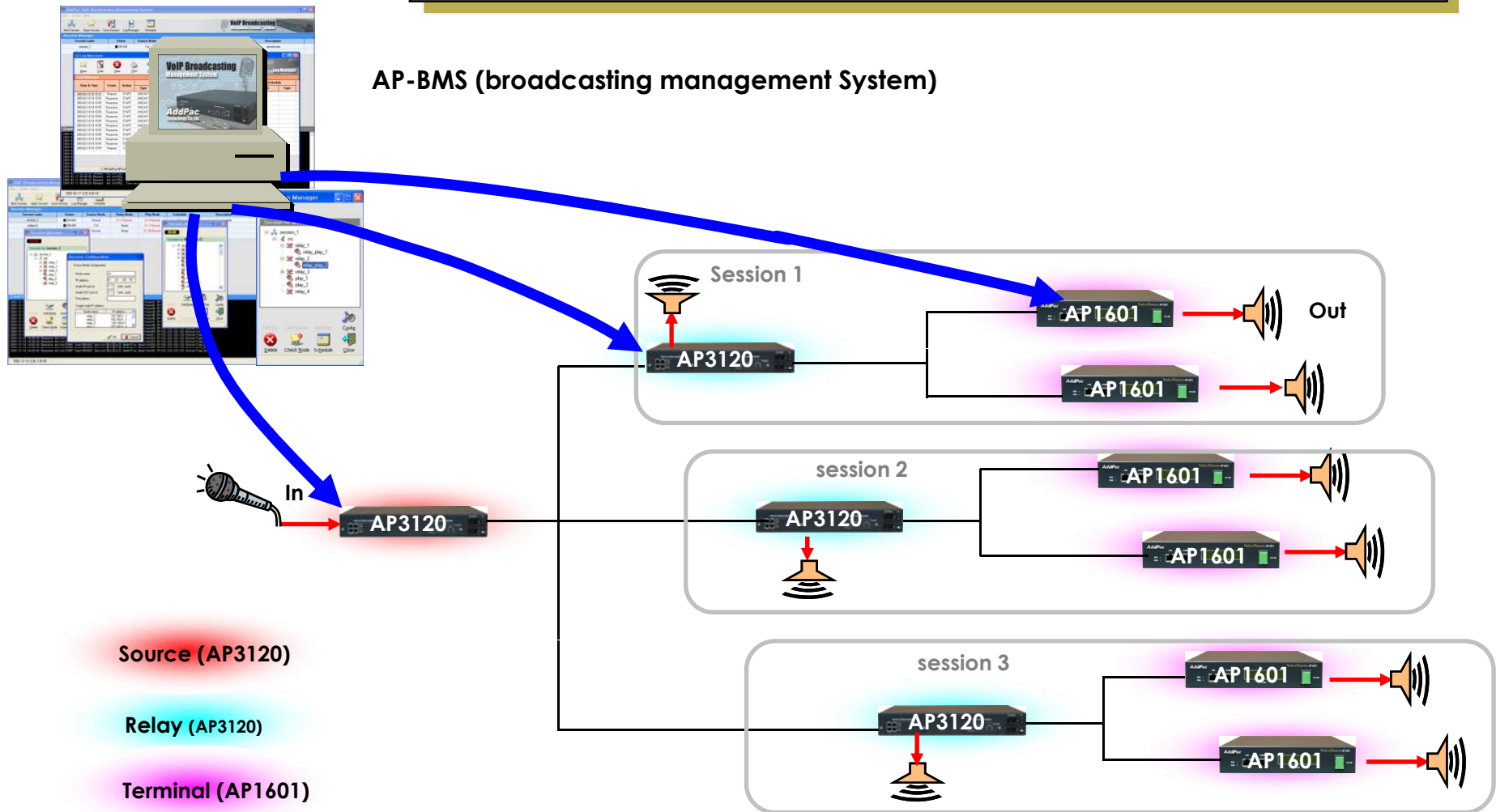

AP3120 Management Scheme

Broadcasting Management System (3)

- **AP-BMS, GUI Management Software**
 - Service Group Configuration
 - Scheduled Broadcasting
 - Status Monitoring
 - Report Service
 - Embedded Media File Manager



Main Interface

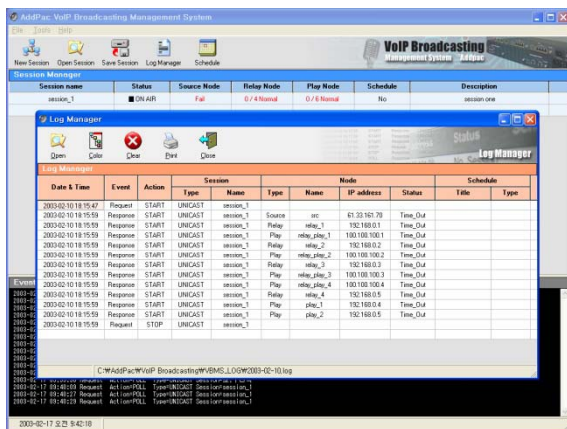

Report Manager

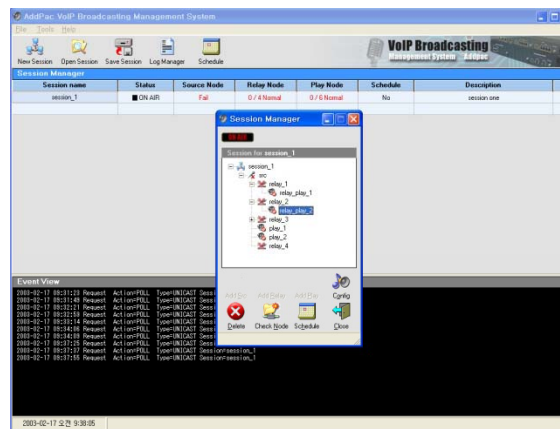

Service Group Configuration

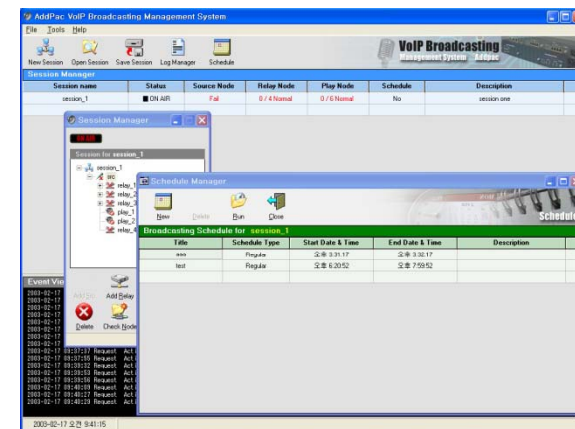

Scheduled Broadcasting

AddPac

www.addpac.com

The Vision of Next Generation Audio Broadcasting

Network Configuration & Case Study



Network Configuration & Case Study

VoIP, Data and IP Broadcasting Network

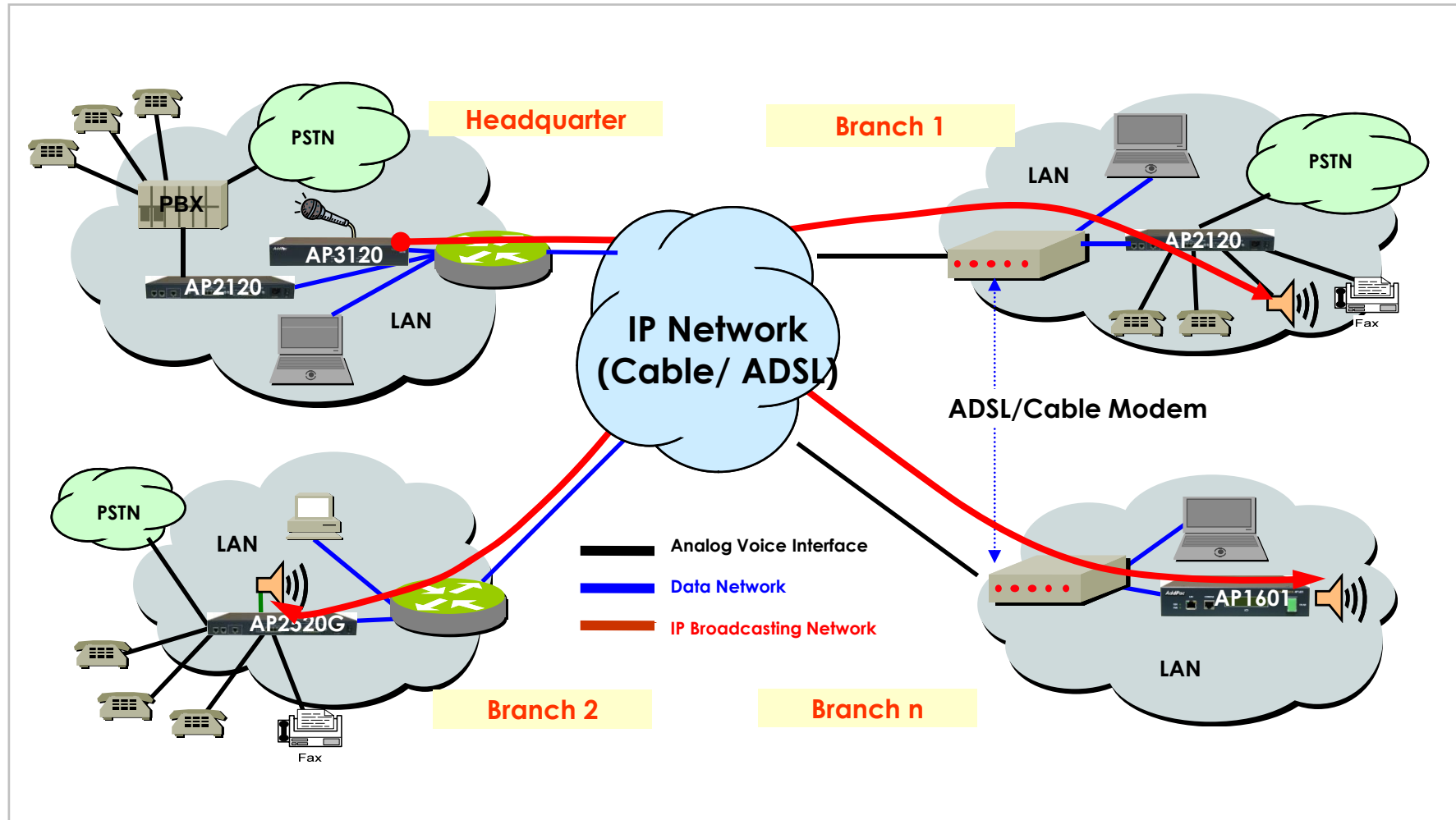

Network Configuration & Case Study

Remote Access Broadcasting Network

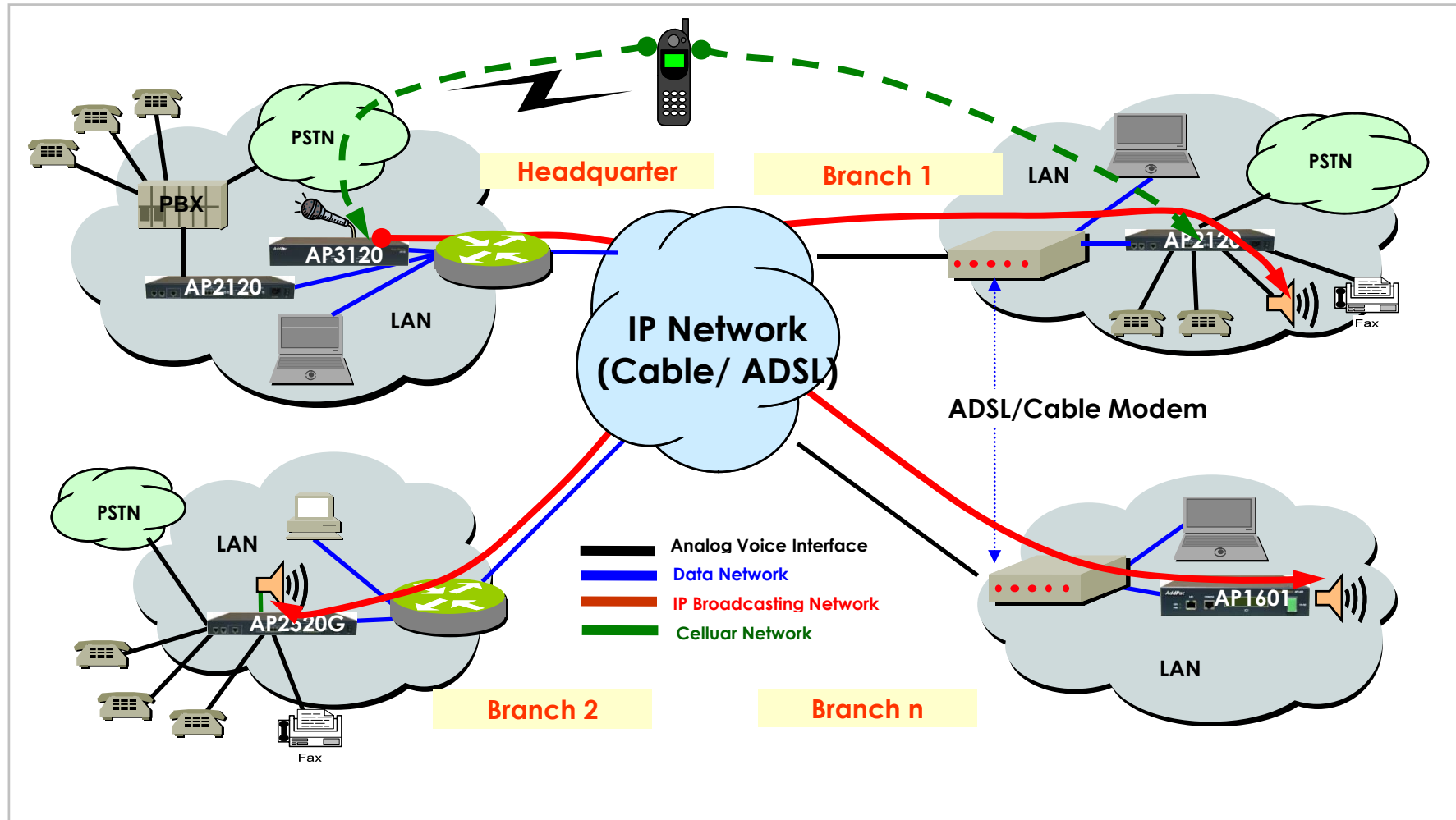

Network Configuration & Case Study

Comprehensive Services

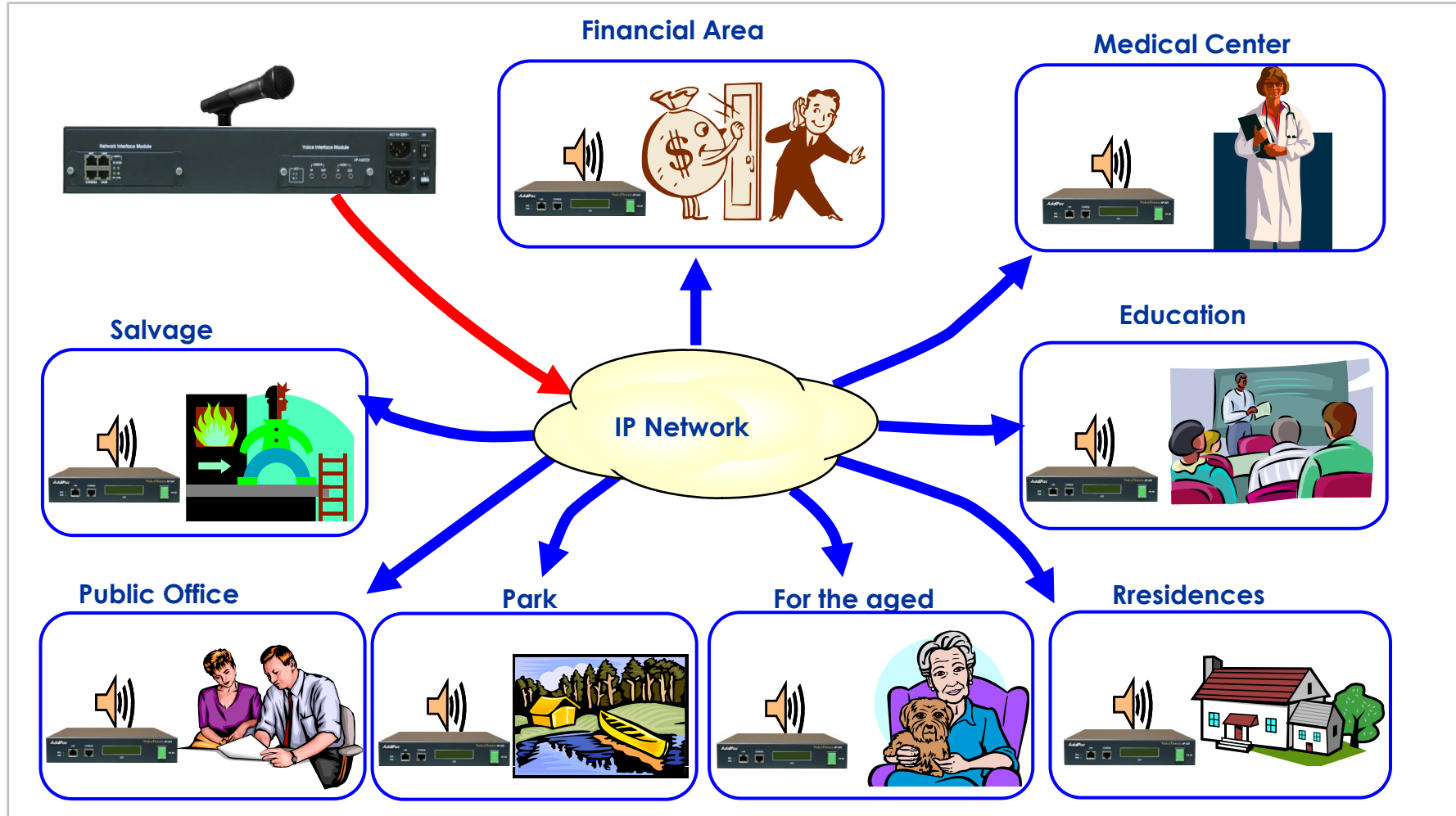

The Vision of Next Generation Audio Broadcasting

Appendix



Appendix

AP3120 Hardware Specification

AP3120 Broadcasting Server	Basic Specifications
CPU	High Performance 64Bit RISC Microprocessor
Audio Interface	AP-Audio2, AP-AUD1S3, AP-AUD1S2O1, AP-MP3
Voice Interface	3-Ports or 2-Ports FXS((AP-AUD1S3/AUD1S3), 1-Ports FXO(AUD1S2O1) Interface
Ethernet Interface	1-Ports 10/100Mbps Ethernet Interface(RJ-45) 1-Ports 10Mbps Ethernet Interface(RJ-45)
Console Port	1-Port RS-232C Console Port(RJ-45)
Flash Memory	4MB High-speed Flash Memory, 8MB for IVR
Base Memory	128MB High-speed SDRAM
Boot Memory	512KB Flash Memory
Power Requirement	VAC110~220V, 50/60Hz, 25Watt
Operating Temperature	0°C ~ 50°C (32 °F ~ 122°F)
Storage Temperature	-40°C ~ 85°C (-40°C ~ 185°F)
Relative Humidity	5% ~ 95% (Non-condensing)
Dimensions	65×441×323mm (H x W x D)
Weight (g)	2.7Kg

Appendix

AP3120 Ordering and Pricing

- **AP3120 IP Broadcasting Server**

- IP Broadcasting Server Hardware

- High-speed 64bit RISC CPU
 - 2-Ports Fast Ethernet
 - 2-Ports RS-232C Console
 - Including Network Cable Set
 - Built-in APOS Internetworking Software
 - Including 1-Year Hardware Warranty

- AP3120-AUDIO2 2Pair Analog Audio-In/Out

- AP3120-MP3 2Pair Analog Audio-In/Out (High Quality Audio Band)

- AP3120-AUD1S3 1Pair Analog Audio-In/Out , FXS 3-Ports

- AP3120-AUD1S2O1 1Pair Analog Audio-In/Out , FXS 2-Ports, FXO 1-Port

- **Pricing**

- AddPac Technology Regional Sales Managers
 - Authorized Sales and Marketing Representatives
 - Please Contact www.addpac.com

Appendix

Services Comparison Table

	IP Broadcasting	Legacy Broadcasting
Network	IP Network including Internet	PSTN
Network Cost	Low	High
Protocol	IP Standard	Private Protocol
Scalability	Unlimited	Limited
Interactive Comm.	Yes	NO
Managing Cost	Low	High
Control Env.	GUI based SW	HW level Control
Remote Control	Yes	No
Easy Use	Yes	No
Audio Level Quality	Yes	NO
Sampling rate	8~22.5KHz	Only 8KHz

Appendix

Detail information about IP Broad. Solution

- AP3120 IP Broadcasting Server → [Move to Web](#)
- AP1601 IP Broadcasting Terminal → [Move to Web](#)
 - AP-AUDIO2 Audio Module → [Move to Web](#)
 - AP-MP3 High Quality Audio Band Module → [Move to Web](#)
 - AP-AUD1S3 Audio Module → [Move to Web](#)
 - AP-AUD1S2O1 Audio Module → [Move to Web](#)
 - AP-PSB Power switching Box → [Move to Web](#)
- Audio Band IP based Broadcasting Solution → [Move to Web](#)
- Voice Band IP based Broadcasting Solution → [Move to Web](#)

Thank you !

www.addpac.com

sales@addpac.com

Phone : +82 2 568 3848

Fax : +82 2 568 3847

AddPac

www.addpac.com

57