

# AP-VAC50

## IP Video Door Phone

High Performance IP Video Door Phone Solution

Interworking with Smart Communicator  
(AddPac Soft Video Phone)



AP-VAC50



AP-SMP100 Smart Communicator

**AddPac**

**AddPac Technology**

2013, Sales and Marketing

# Contents

- Network Diagram
  - Integrated Door Access Control and Call Control
  - Legacy PBX Environment
  - Legacy IP-PBX Environment
  - Interworking with Smart Communicator
- DACS System Message Flow
  - Registration and Keep Alive
  - Access Privilege and Schedule Download
  - RF Card Read/Write and Registration
  - Door Open by RF Card or Password
  - Door Open by AP-SMP100 Smart Communicator



# Network Diagram

## Integrated Door Access Control and Call Control

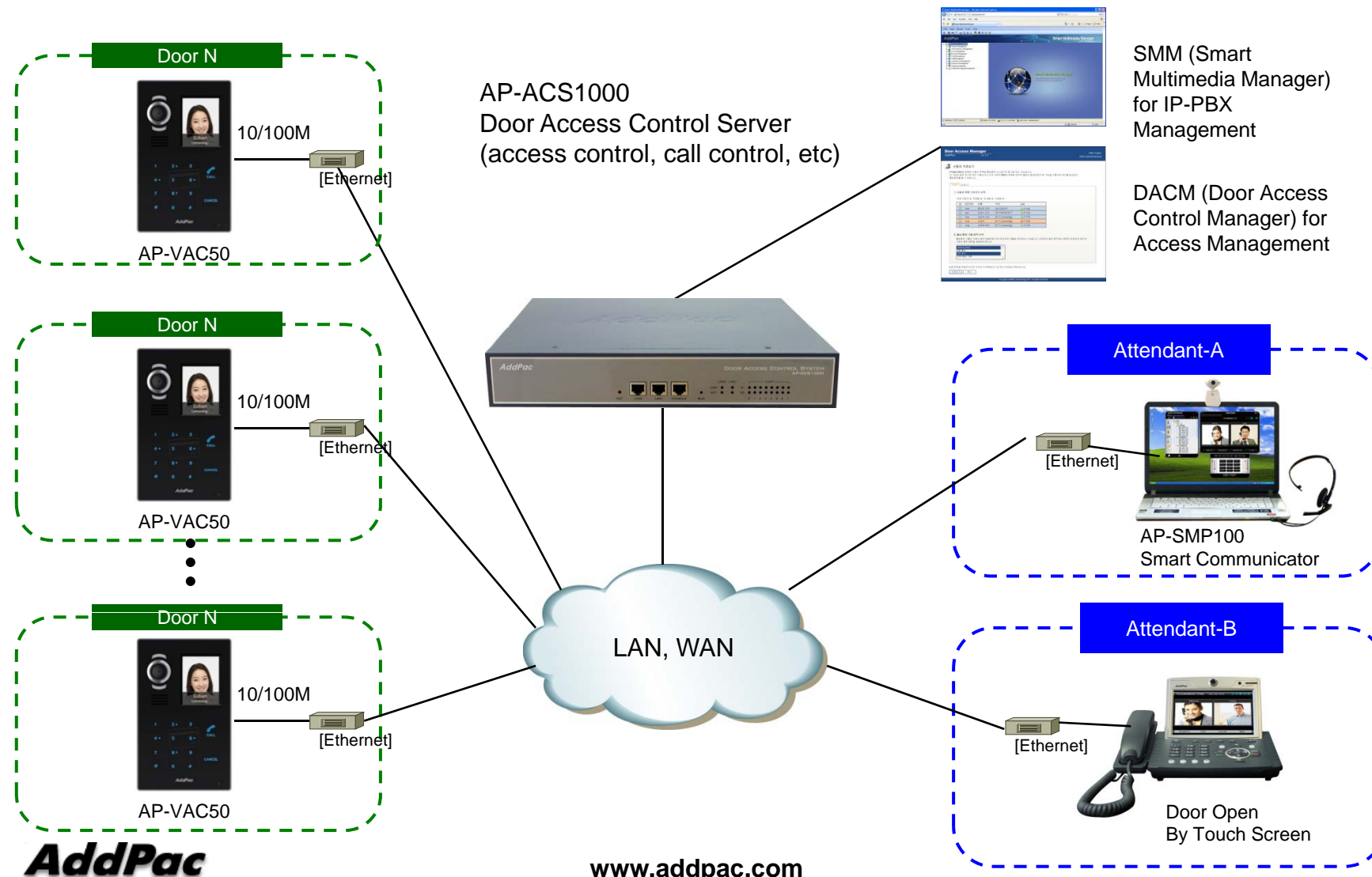

# Network Diagram

## Legacy PBX Environment

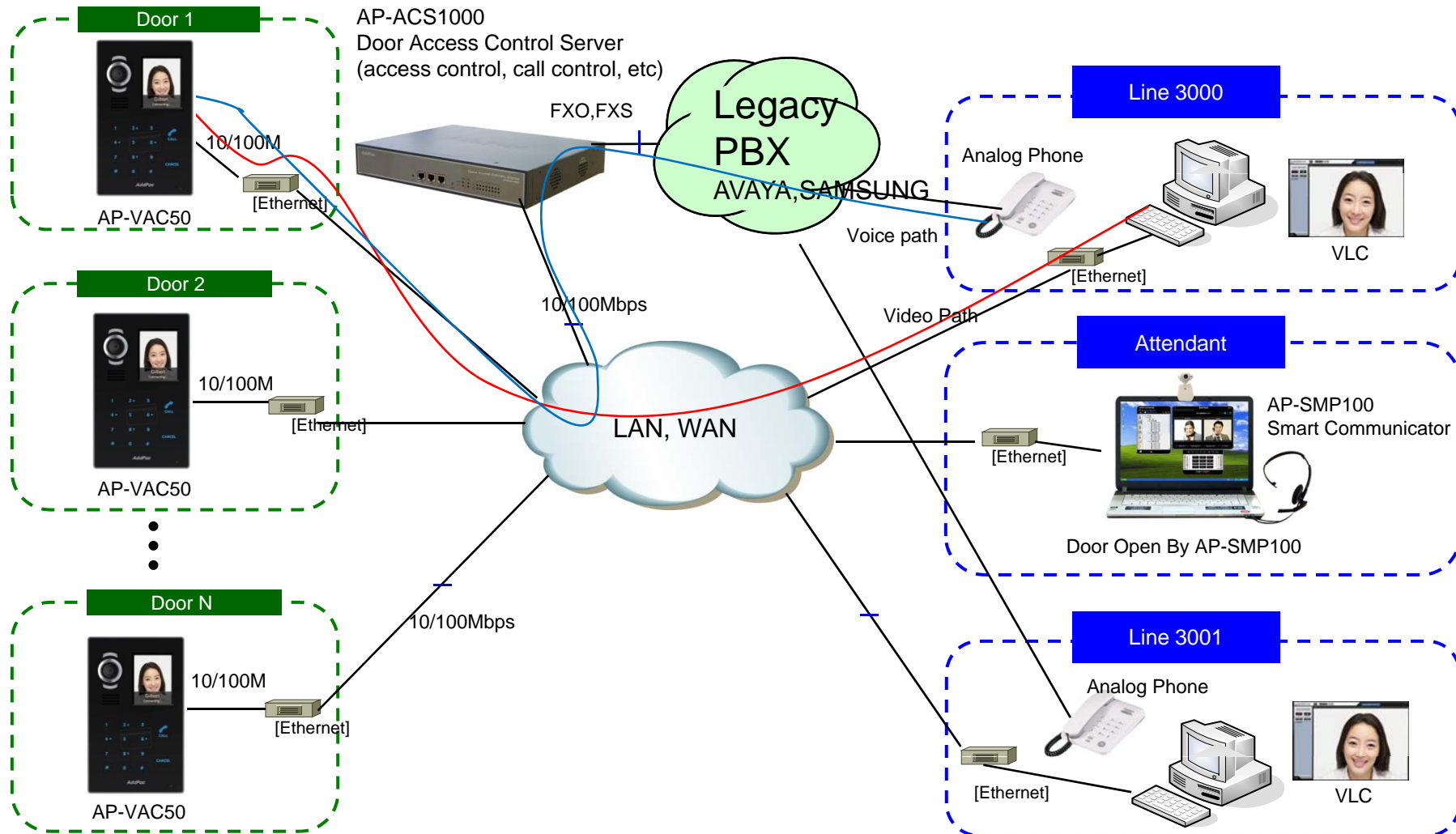

# Network Diagram

## Legacy IP-PBX Environment

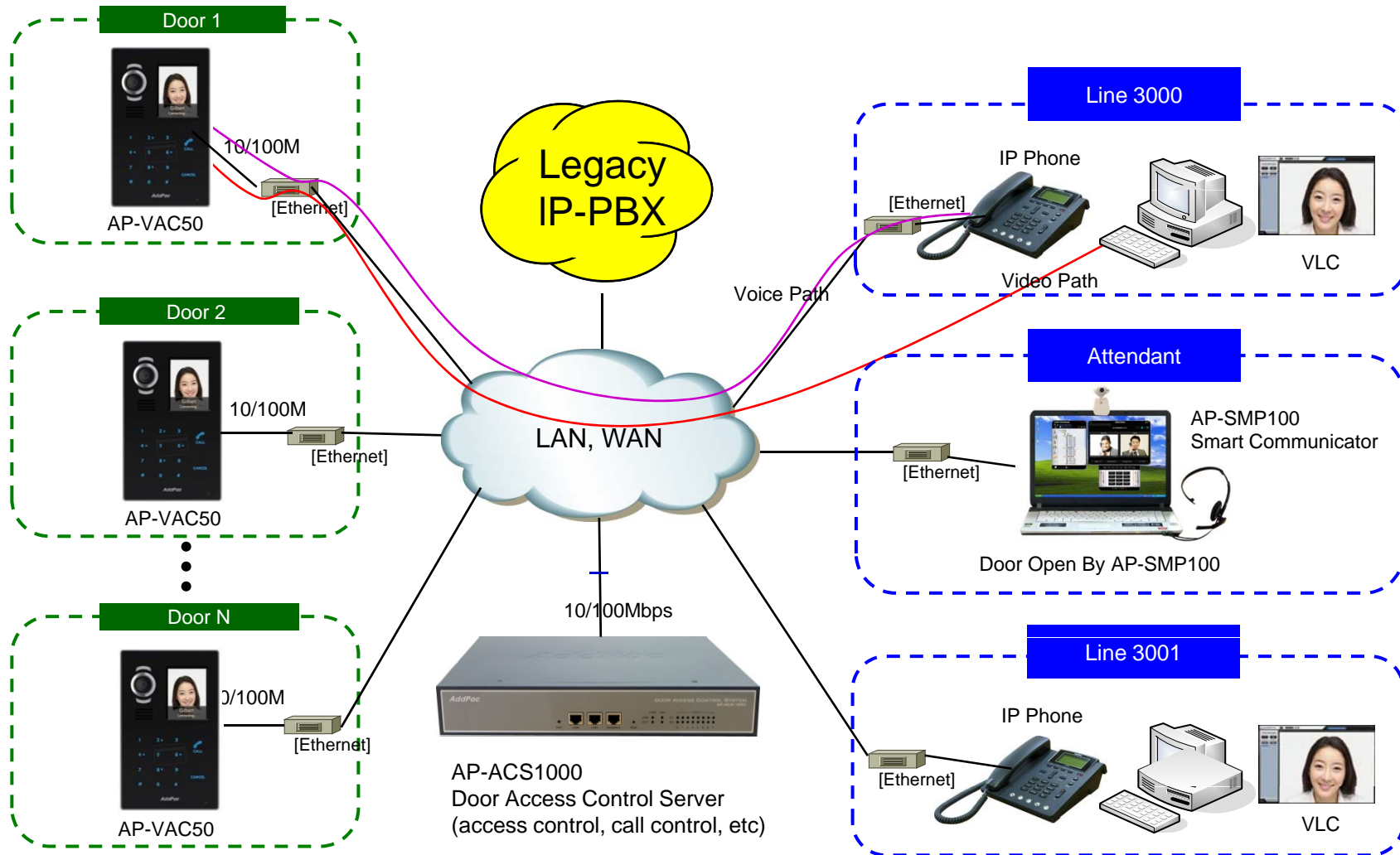

# Network Diagram

## Interworking with Smart Communicator

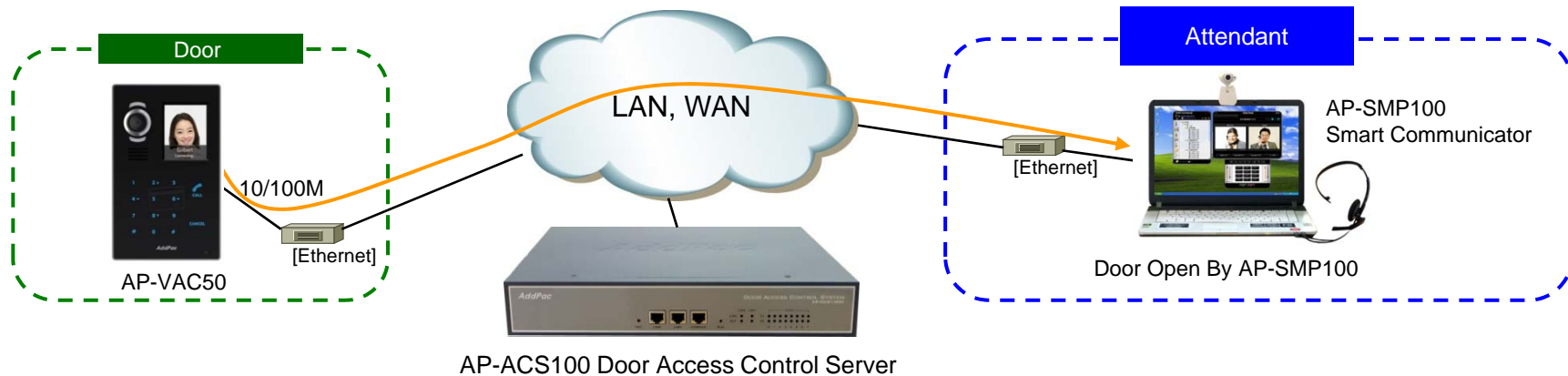

- Door Open By AP-SMP100 Soft key (Feature Code)
- AP-VAC50 security Option
  - Video Display Mute (Local View Only)
- AP-SMP100 security Option
  - Local Camera Mute (Privacy) On/Off
  - Support Camera Mute Image



# DACS System Message Flow

# DACS System Message Flow

## Registration and Keep Alive

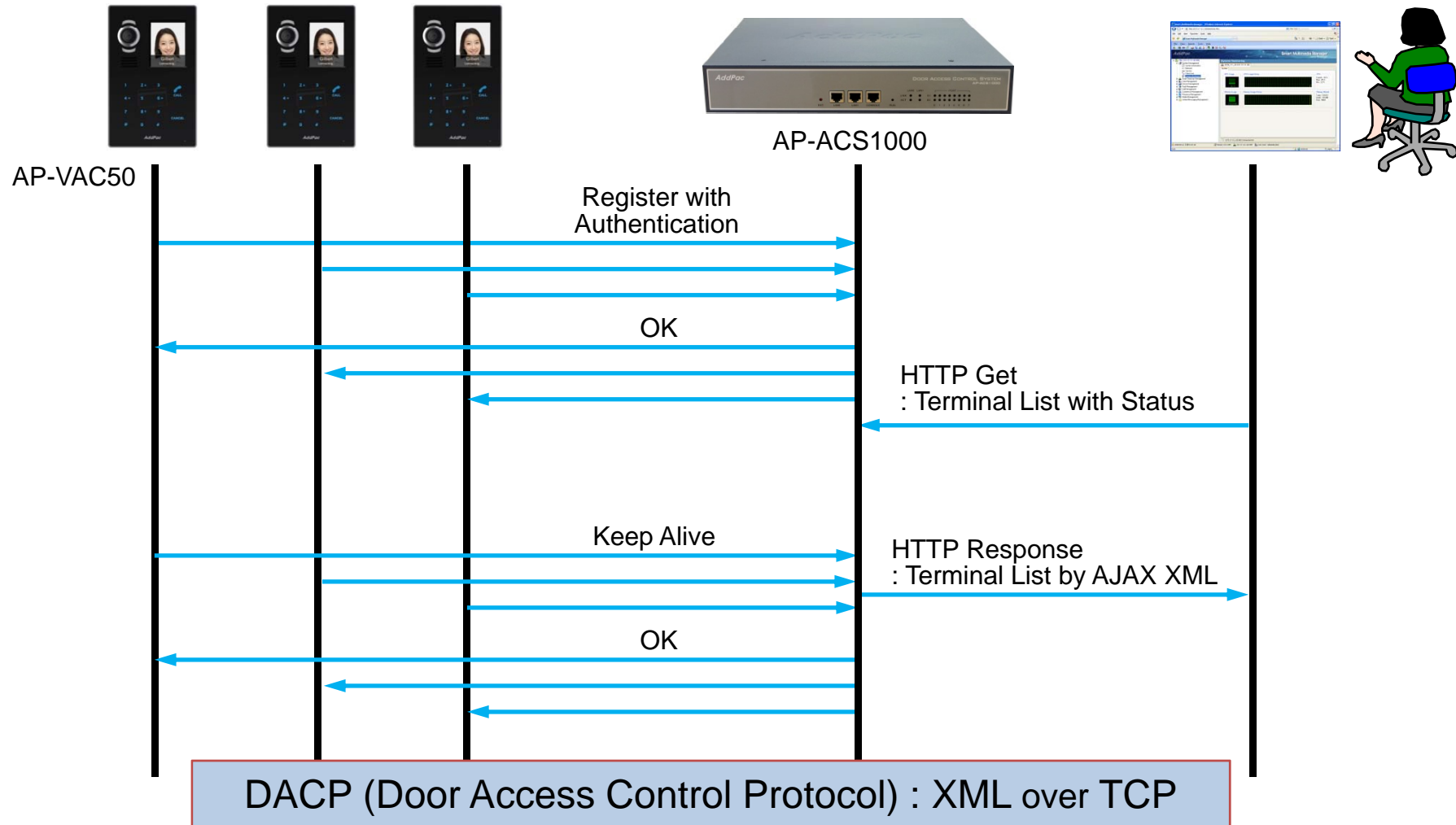



# DACS System Message Flow

Access Privilege and Schedule Download

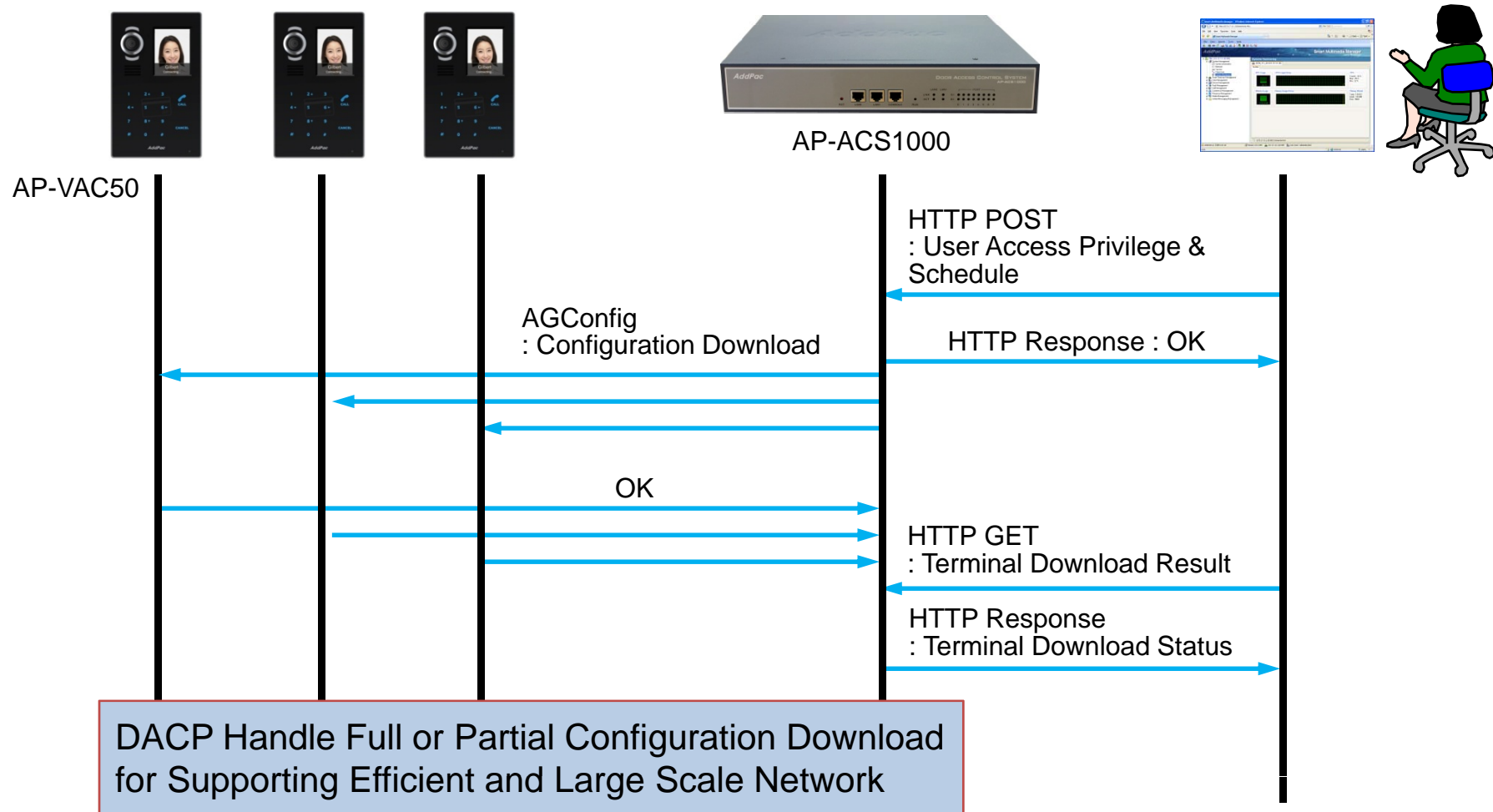

# DACS System Message Flow

## RF Card Read/Write and Registration

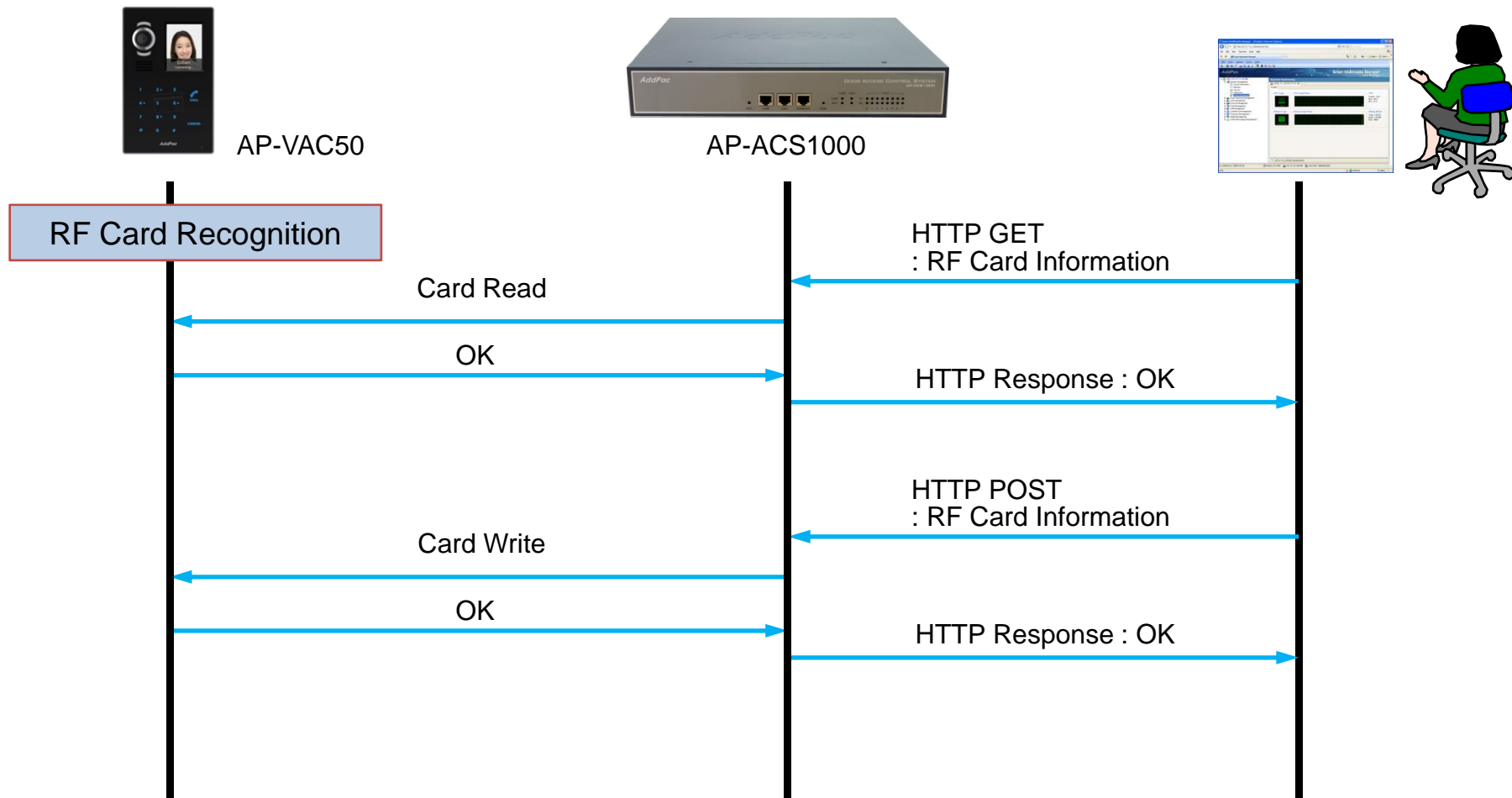

# DACS System Message Flow

Door Open by RF Card or Password

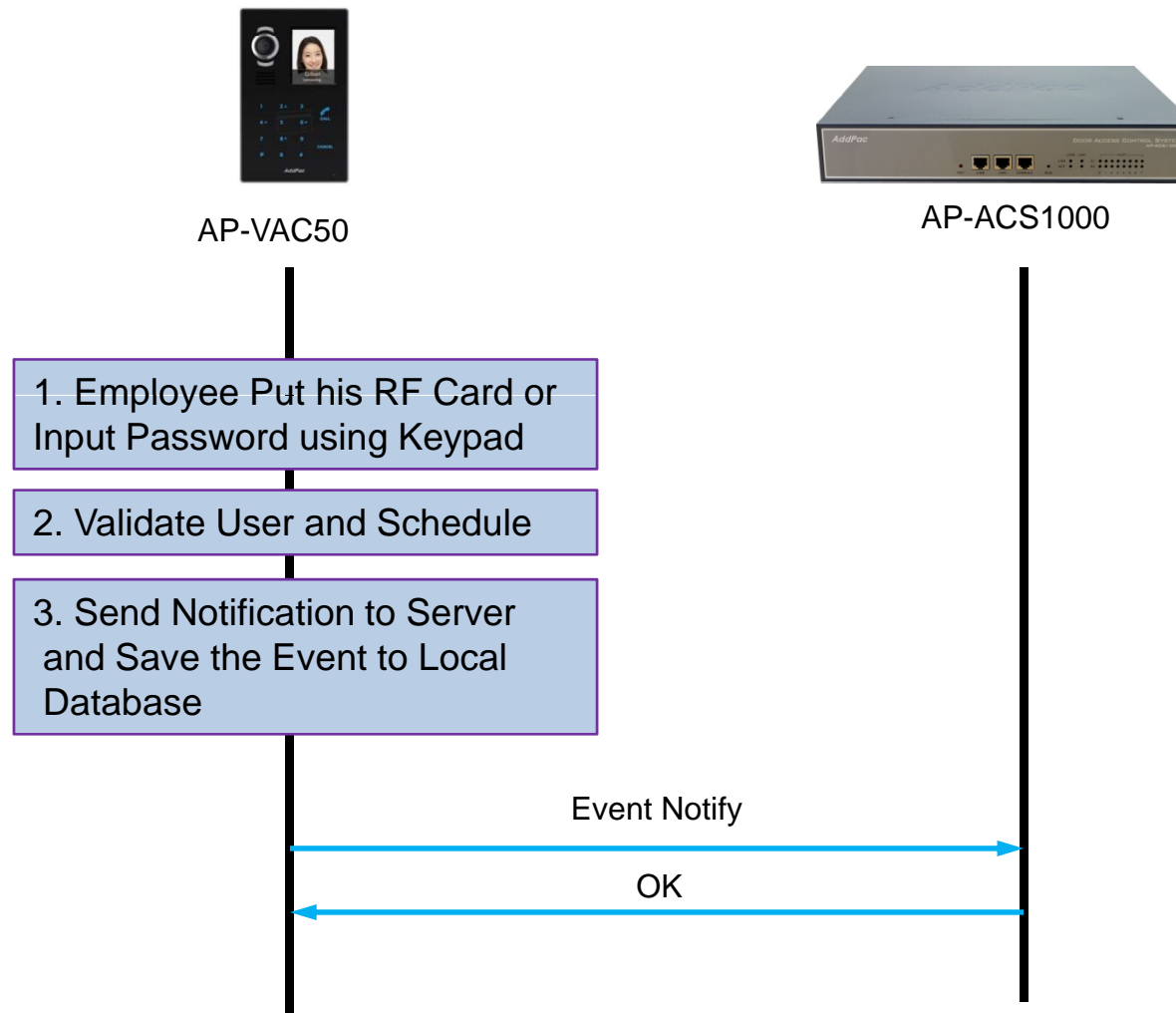

# DACS System Message Flow

## Door Open by AP-SMP100 Smart Communicator

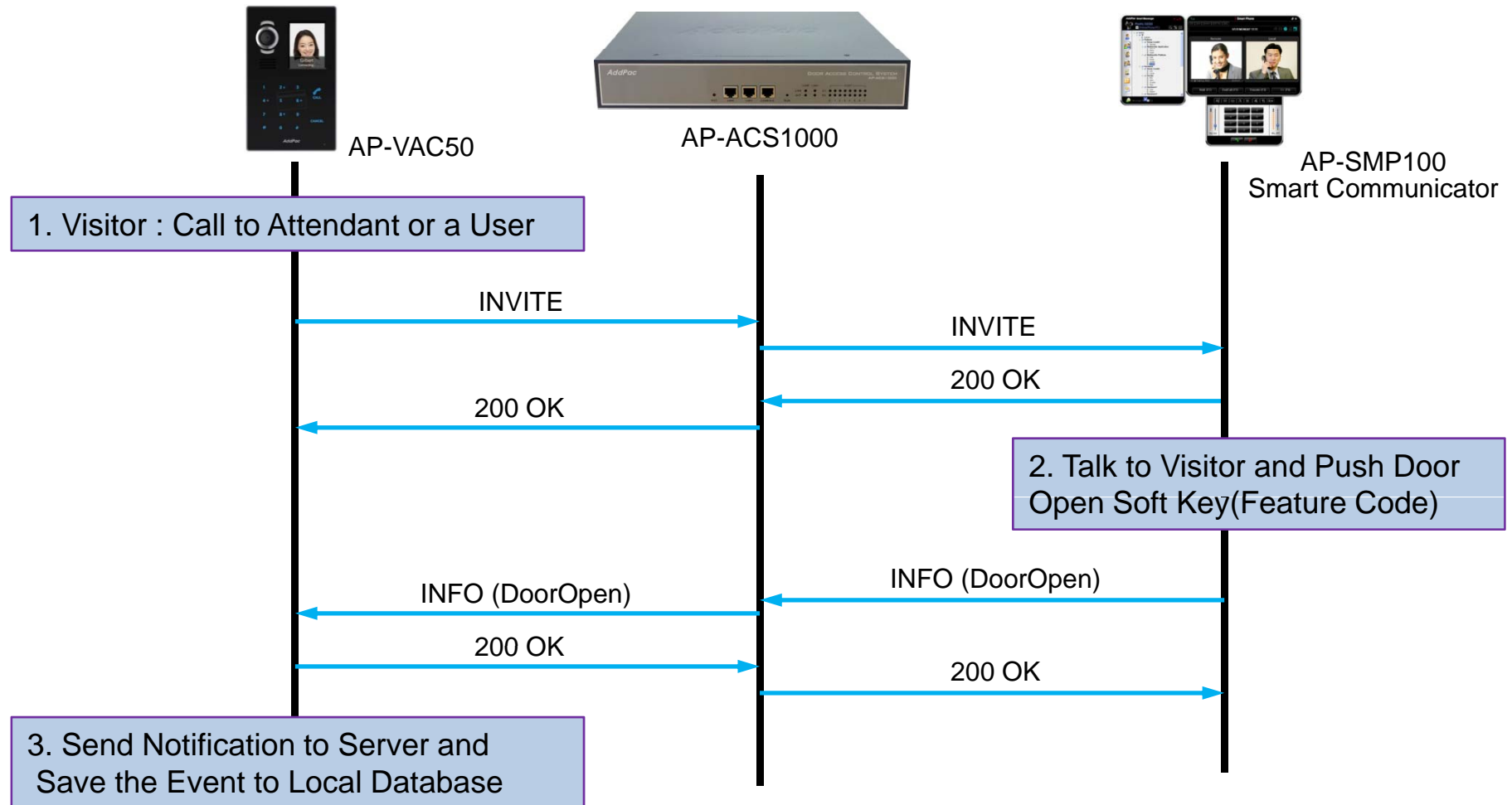



# Thank you!

**AddPac Technology Co., Ltd.**  
Sales and Marketing

Phone +82.2.568.3848 (KOREA)

FAX +82.2.568.3847 (KOREA)

E-mail [sales@addpac.com](mailto:sales@addpac.com)