

AP-ACS2000

Door Access Control Server

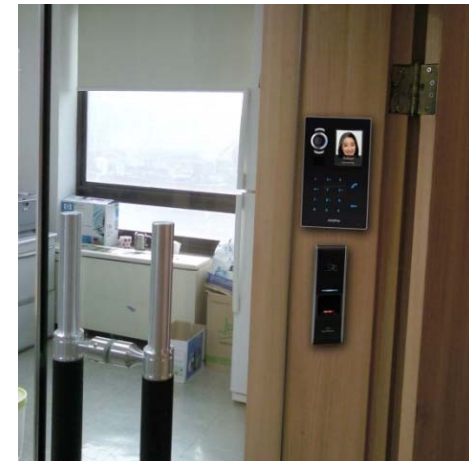

AddPac

AddPac Technology

2014, Sales and Marketing

Contents

- DACS(Door Access Control System) Network Diagram
- AP-ACS2000 DACS Main Features
- AP-ACS2000 DACS Hardware Specification
- DACS System Message Flow (Examples)
- DACM (Door Access Control Manager)
- Open API for Third Party Controller
- IP Video Door Phone Comparison Table
- IP Video Wall PAD Comparison Table

Integrated Door Access Control and Call Control

AP-ACS2000 DACS (Door Access Control System)

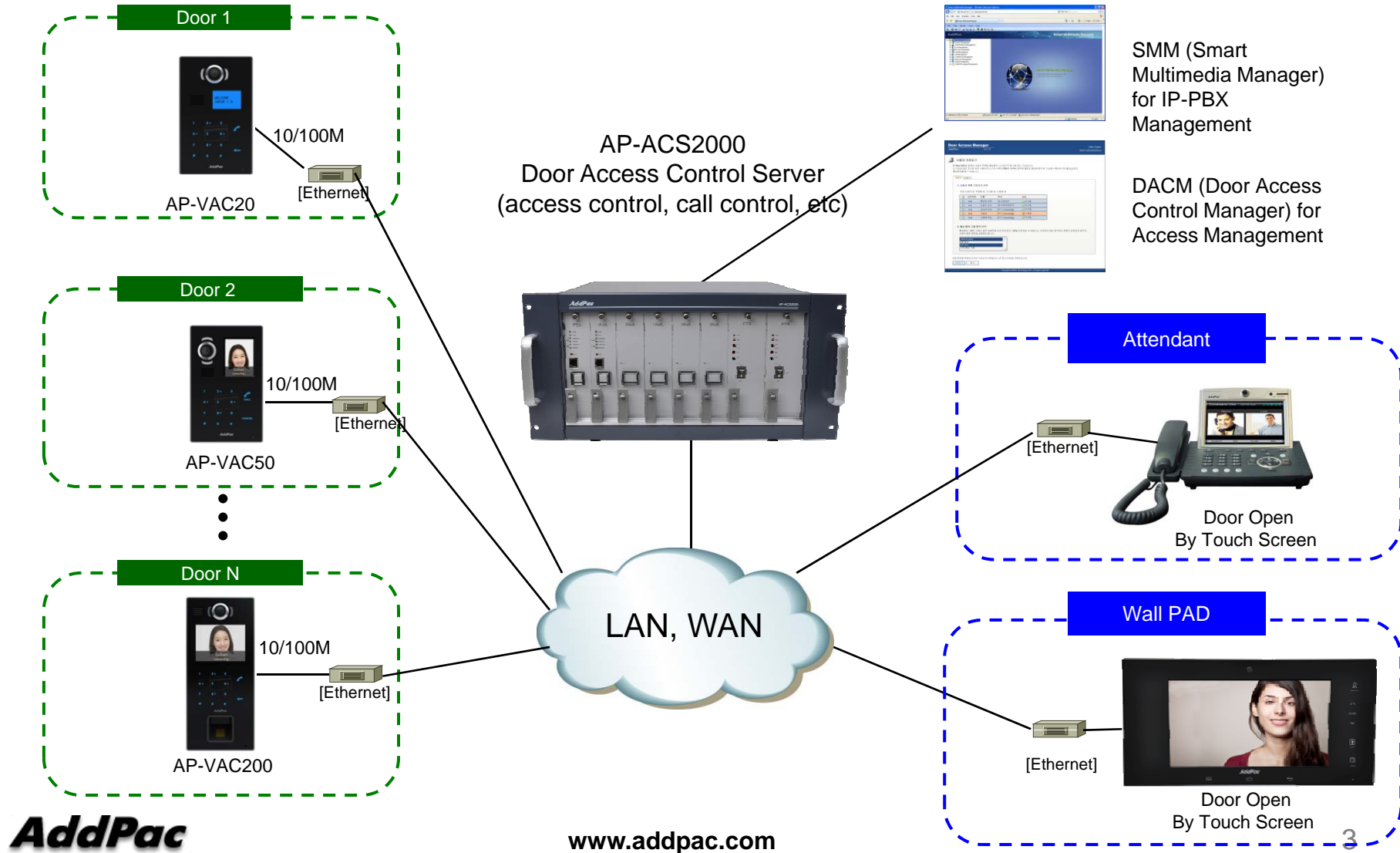

IP-PBX Environment

AP-ACS2000 DACS (Door Access Control System)

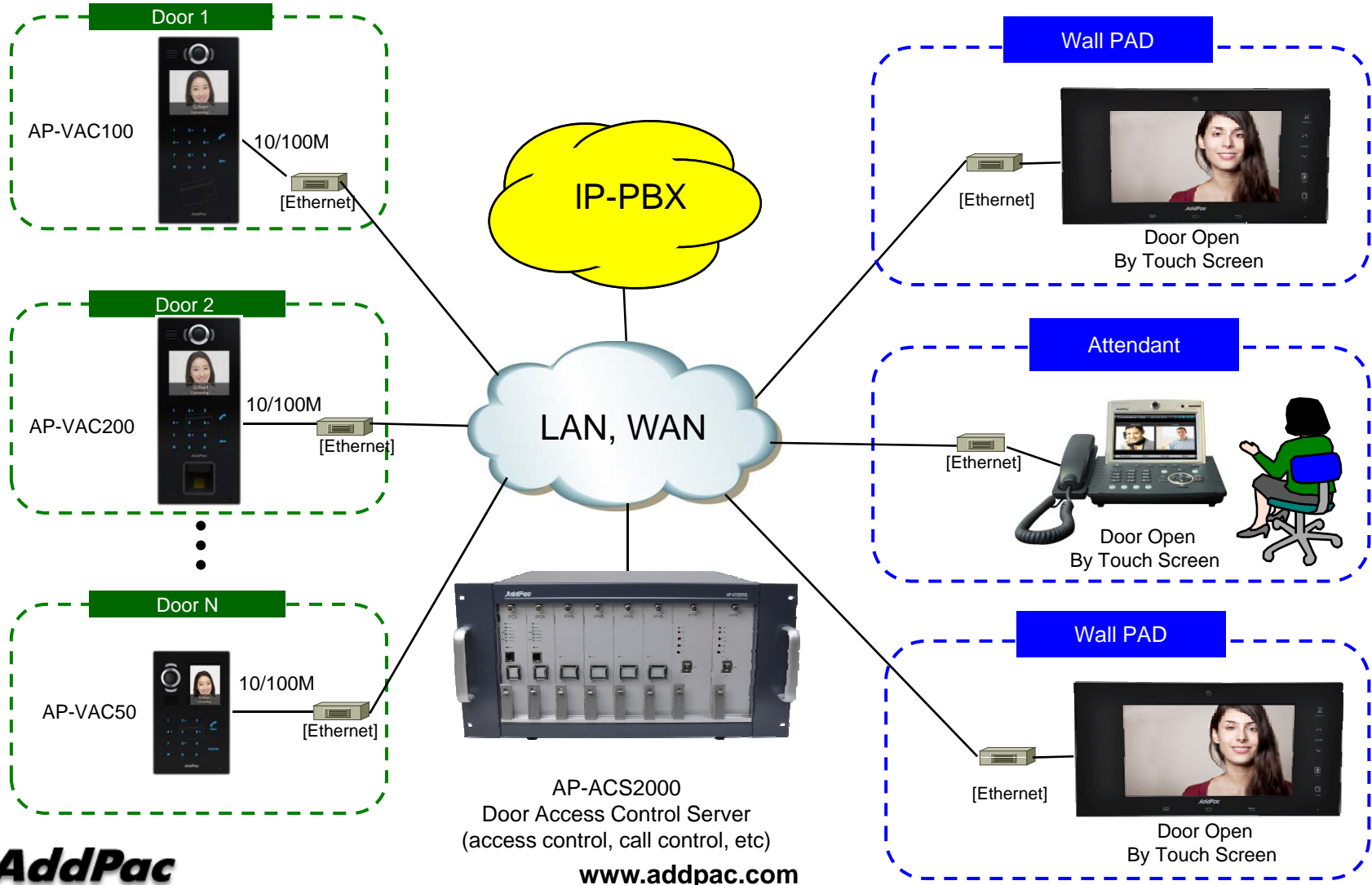

Main Features

AP-ACS2000 DACS (Door Access Control System)

- Door Access Control Application System
- SIP Application Server, Proxy, Registrar and Location Server
- Multiple ITSP Trunk with SIP & H.323 Accounts Support
- High Performance RISC & Programmable DSP Architecture
- Smart Multimedia Manager for IP-PBX Management
- DACM(Door Access Control Manager)
- IPv4/IPv6 based Dual Network Protocol Support
- Internal/External RTP Proxy Function Support
 - External RTP Proxy Server for Private Address : AP-RS2000
- Fault Tolerant and Scalability Architecture
- Firmware Upgradeable Architecture
- Dual System Redundancy Architecture
 - Two(2) 3.5 Inch Hard Disk (RAID 1) / System
 - Two(2) Gigabit Ethernet Interface / System
- Dual Redundancy Power Module

Hardware Features

AP-ACS2000 DACS (Door Access Control System)

- High-End Microprocessor Computing Power
- Main Chassis
 - Dual Redundancy CPU Boards for System Fault Tolerant
 - Two(2) 10/100/1000Mbps Gigabit Ethernet
 - One(1) RS-232C Console (RJ45)
 - Two(2) 3.5 Inch Hard Disk Interface Slot (RAID 1)
 - Dual Redundancy Power Supply Module
 - Hot-Swap Features

Hardware Specification

AP-ACS2000 DACS (Door Access Control System)

AP-ACS2000 Front Side

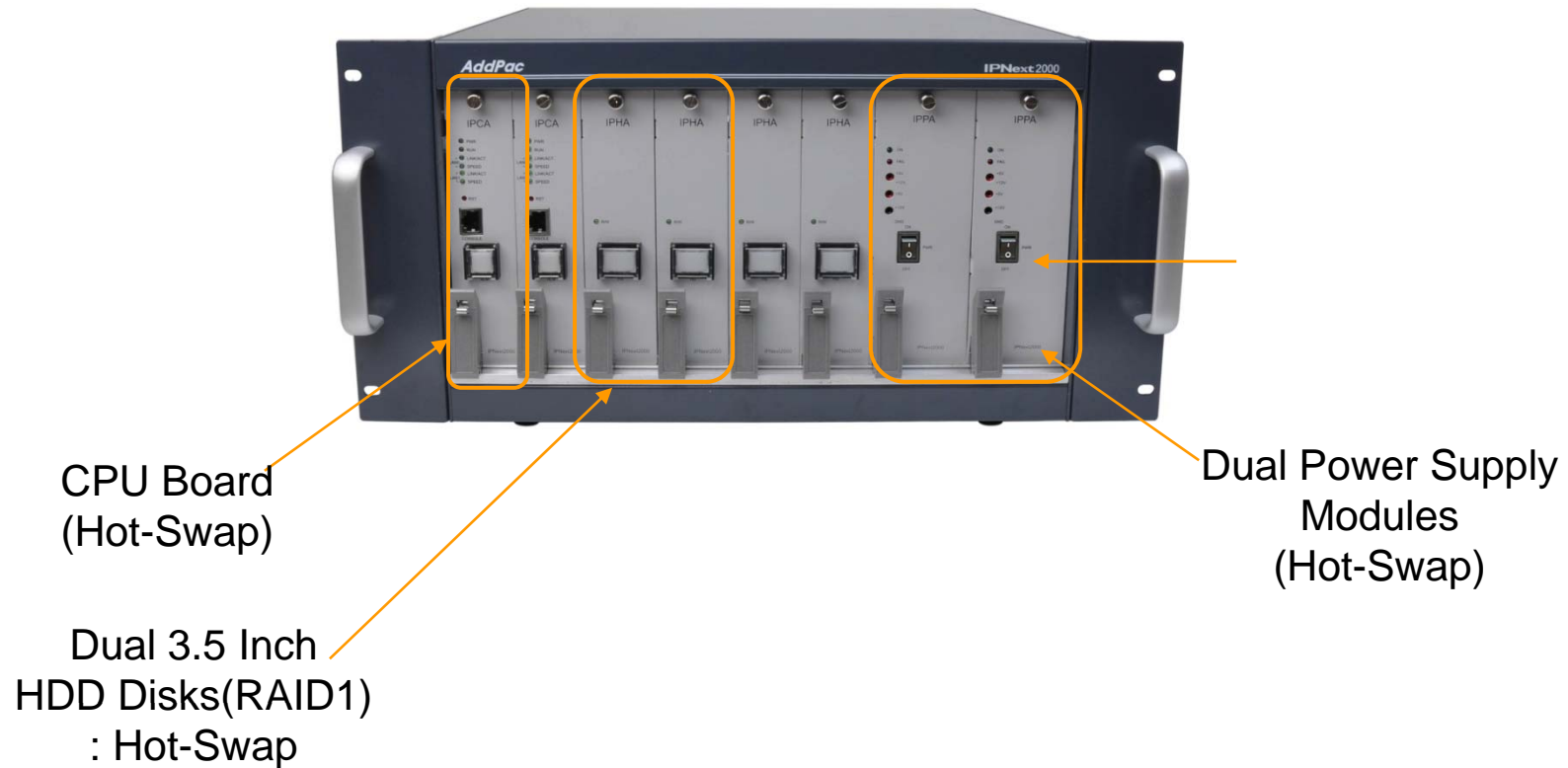

Hardware Specification

AP-ACS2000 DACS (Door Access Control System)

AP-ACS2000 Back Side

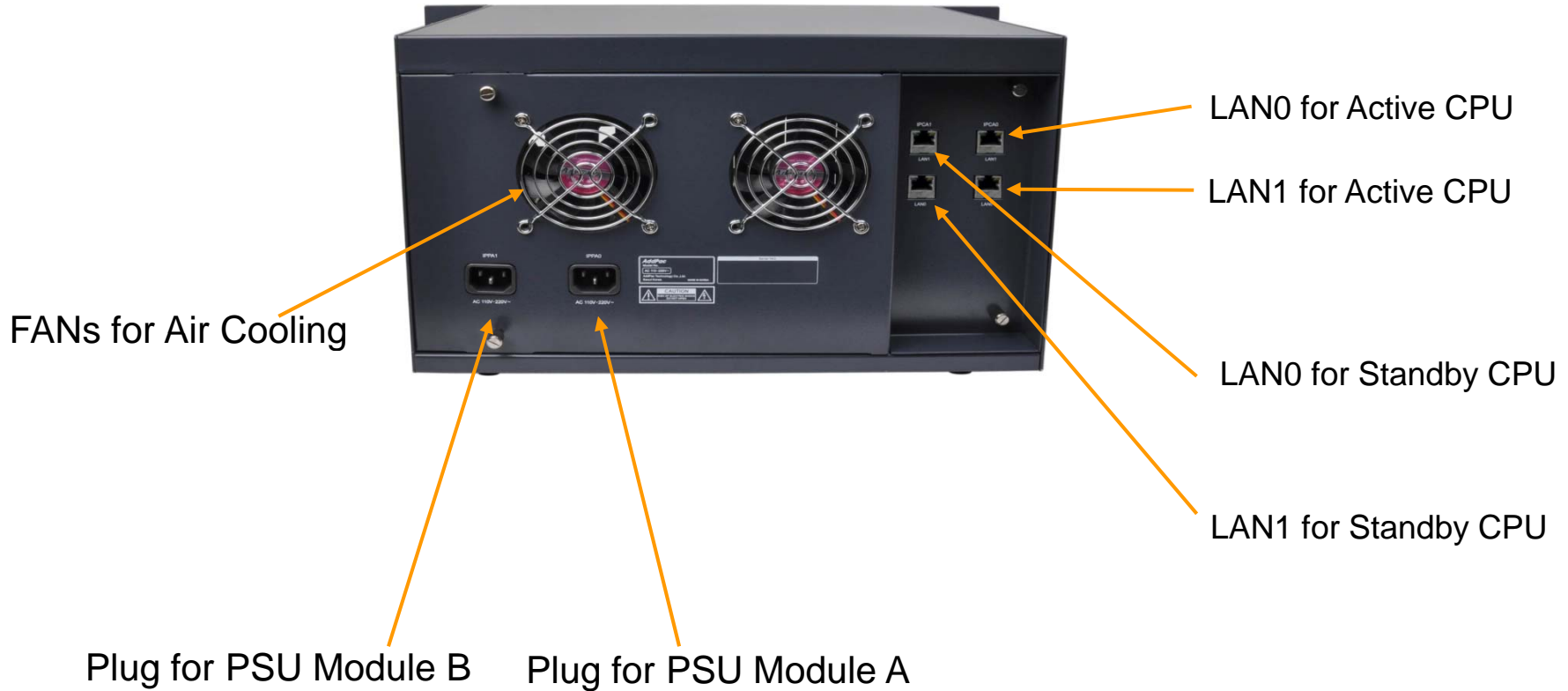



DACS System Message Flow

DACS System Message Flow

Registration and KeepAlive

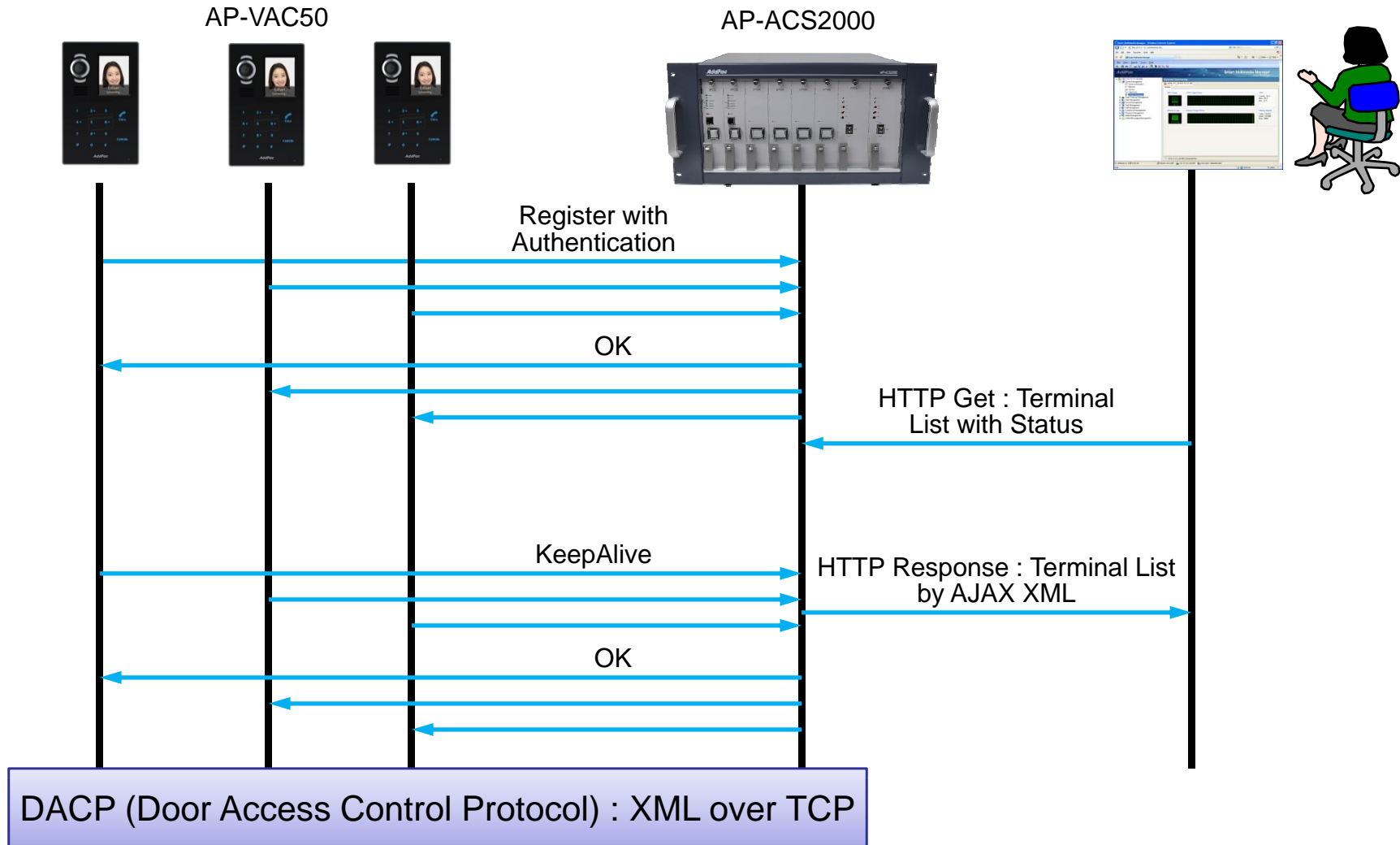

DACS System Message Flow

Access Privilege and Schedule Download

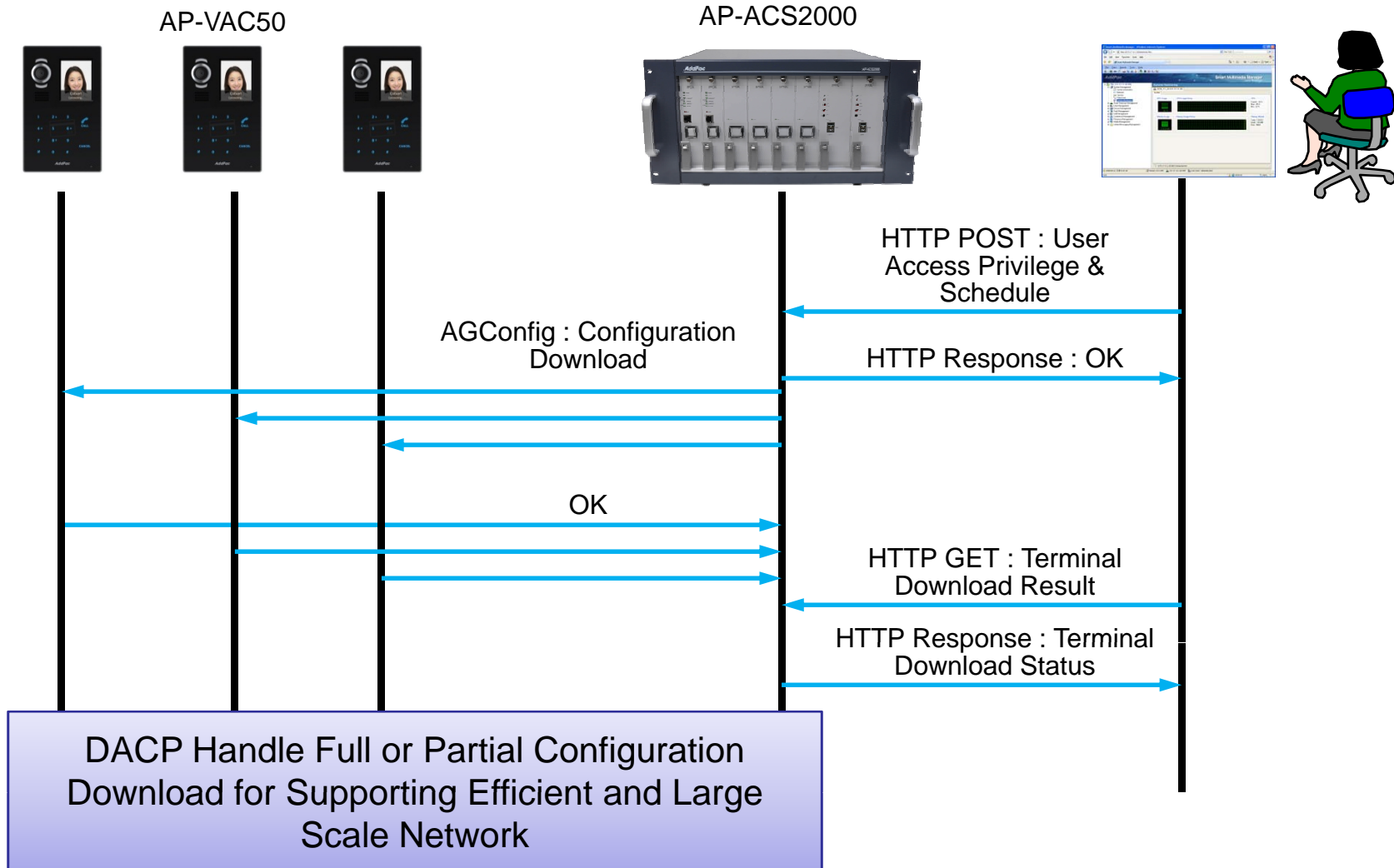

DACS System Message Flow

RF Card Read/Write and Registration

AP-VAC50



AP-ACS2000

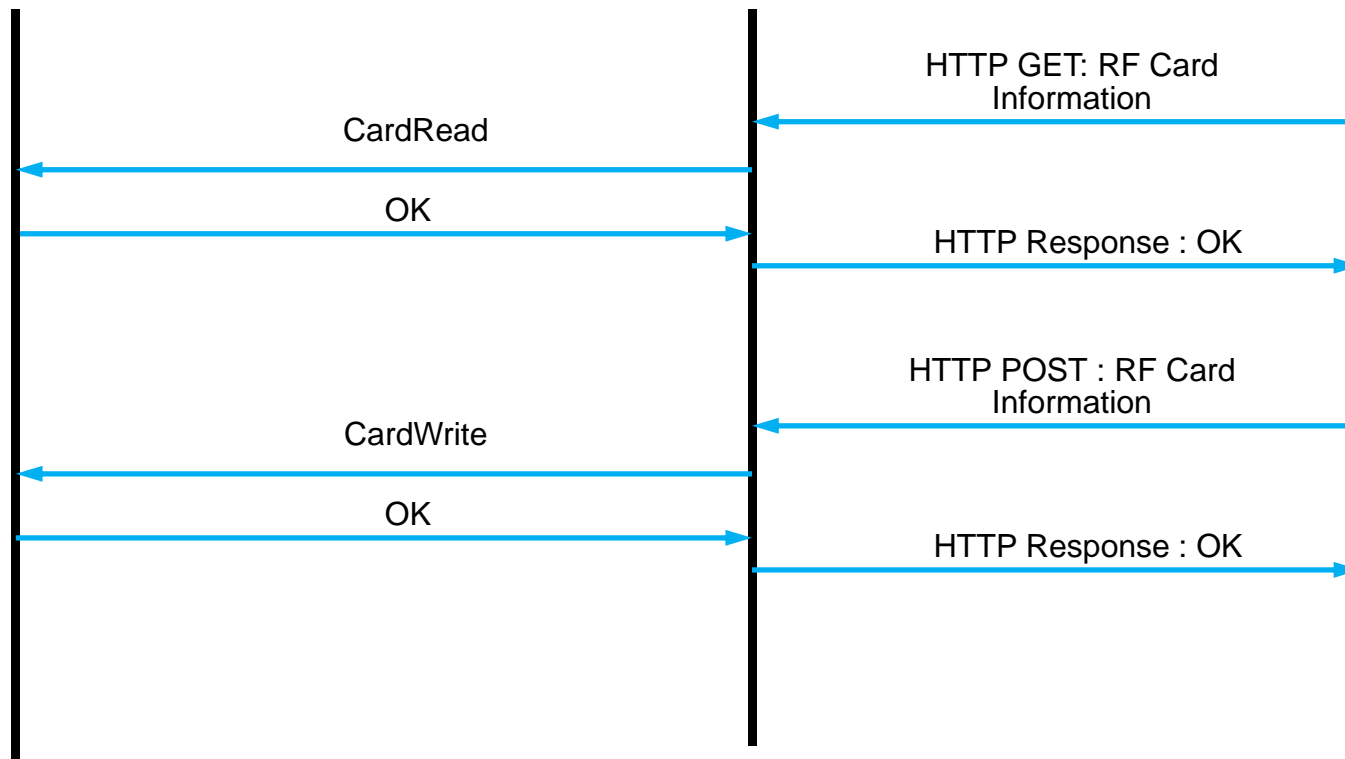
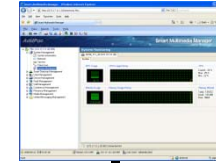

DACS System Message Flow

Door Open by RF Card or Password

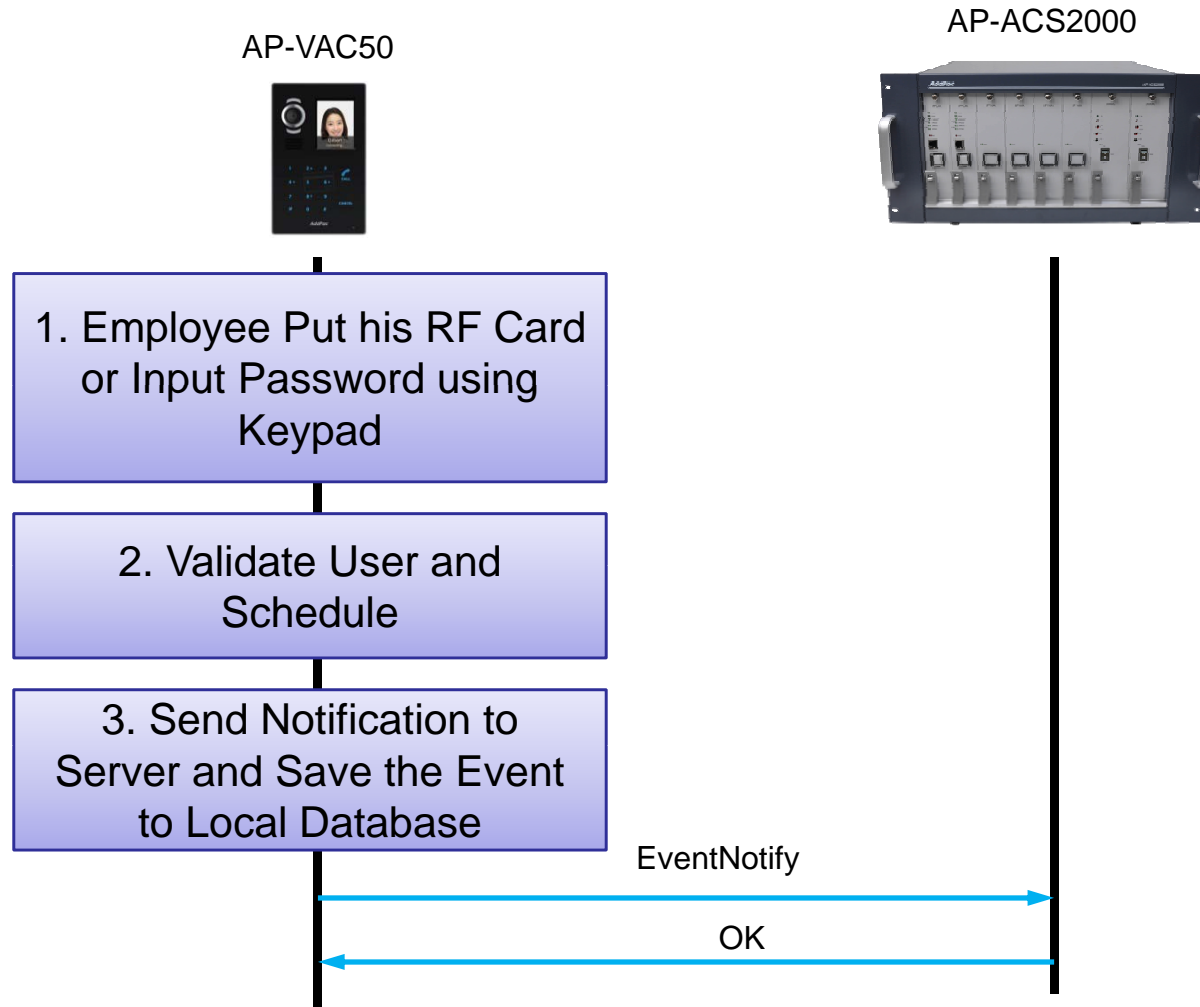

DACS System Message Flow

Door Open by Other Terminal

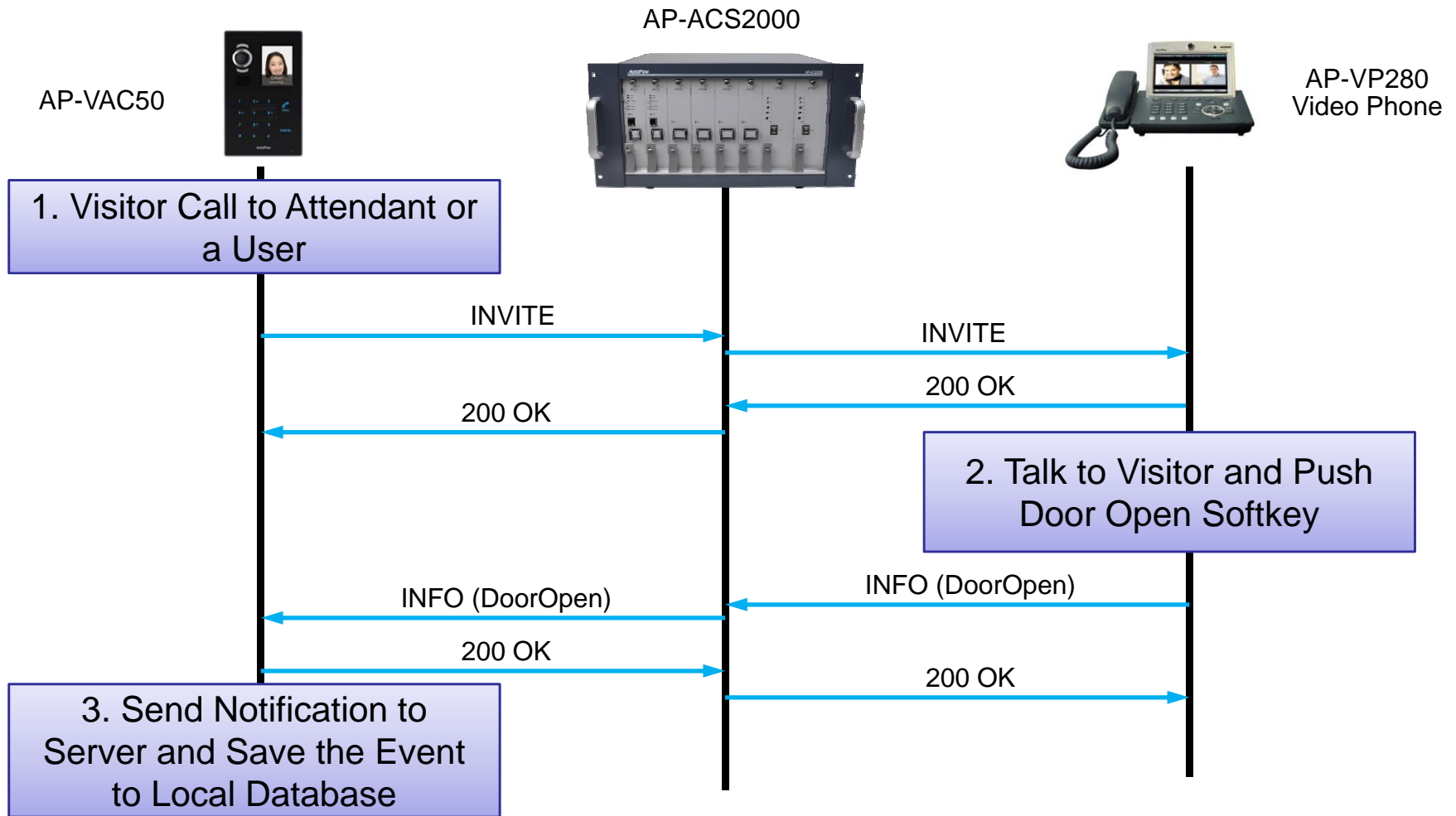



Door Access Control Manager for AP-ACS2000

DACM (Door Access Control Manager)

Main Web Page

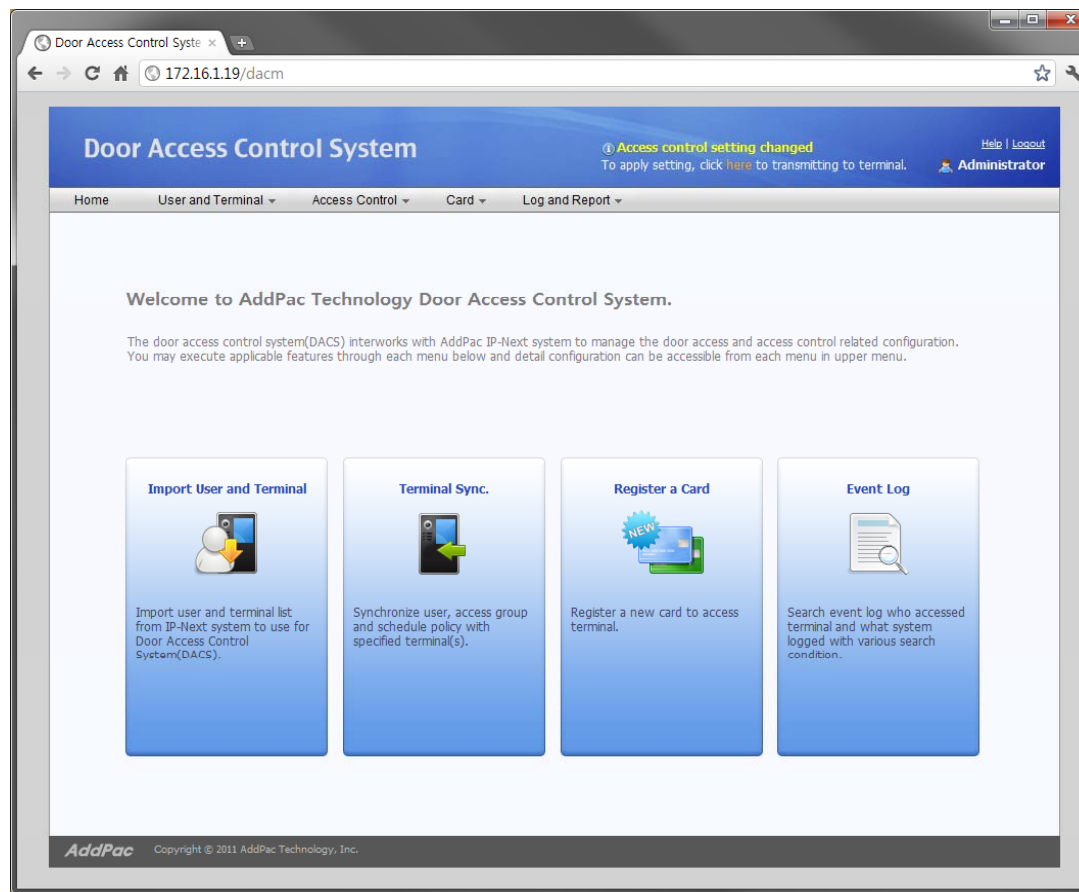

DACM (Door Access Control Manager)

Import User and Terminal

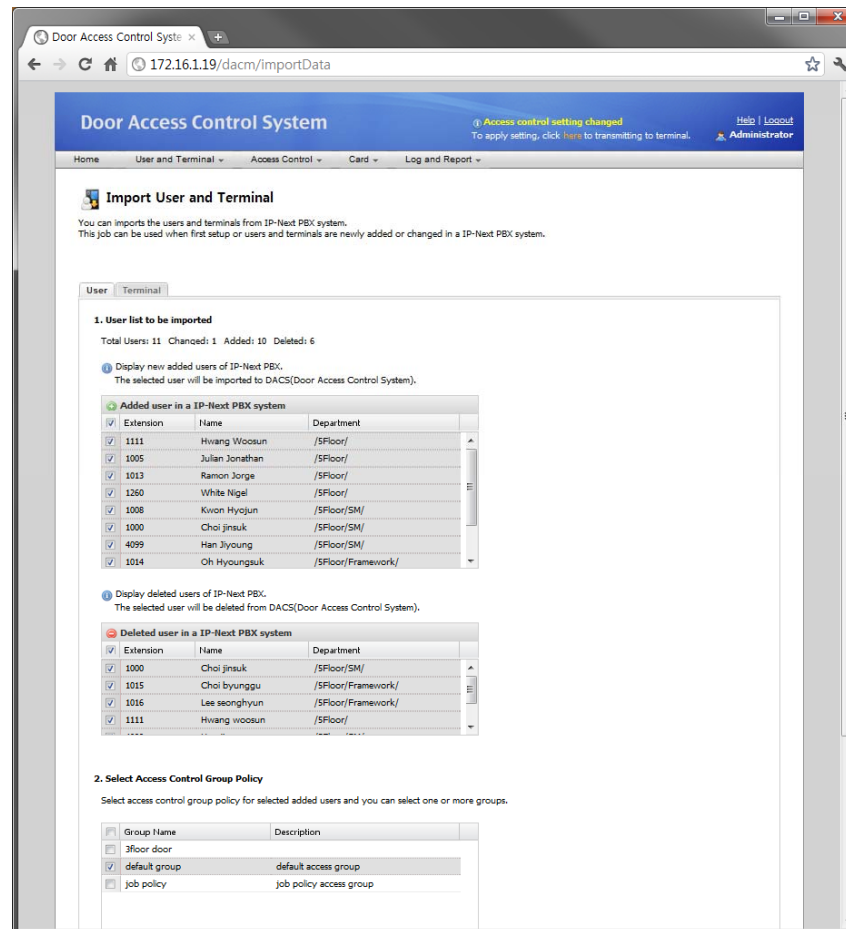

DACM (Door Access Control Manager)

User List

The screenshot shows a web browser window displaying the 'Door Access Control System' user list. The page title is 'Door Access Control System' and the URL is '172.16.1.19/dacm/userList'. A notification at the top right states 'Access control setting changed' with a link to 'here' and a 'Logout' button. The user is logged in as 'Administrator'. The main content area is titled 'User List' and includes a search bar with a dropdown set to 'All Users' and an 'Import User' button. Below the search bar is a table with the following data:

	Extension	Name	Department	Access Policy	Date Created	Modify	Delete
1	1000	Choi jinsuk	/SFloor/SM/	Access Allow	2011-07-22 15:50:01		
2	1008	Kwon hyojun	/SFloor/SM/	Access Allow	2011-07-22 15:50:00		
3	1014	Oh hyongsuk	/SFloor/Framework/	Access Allow	2011-07-22 15:50:01		
4	1015	Choi byunggu	/SFloor/Framework/	Access Allow	2011-07-22 15:50:01		
5	1016	Lee seonghyun	/SFloor/Framework/	Access Allow	2011-07-22 15:50:01		

At the bottom of the page, there is a pagination control showing 'Page 1 of 1' and a 'Total: 5' indicator. The footer contains the 'AddPac' logo and 'Copyright © 2011 AddPac Technology, Inc.'.

DACM (Door Access Control Manager)

Terminal List

Door Access Control System

Access control setting changed
To apply setting, click [here](#) to transmitting to terminal.

Help | Logout
Administrator

Home User and Terminal Access Control Card Log and Report

Terminal List

Display the registered door phone lists imported from IP-Next PBX system.

Import Terminal

	Terminal Name	Description	Status	Extension	IP Address	Model Name	Version	Date Created	Detail View
1	2floor door terminal	2Floor door ter...	Connected	1006	172.16.10.4	AP-VAC50		2011-07-29 17:08:50	
2	3floor door terminal	3Floor door ter...	Connected	1002	172.16.10.1	AP-VAC20	8.50.001	2011-07-22 15:50:01	
3	5floor door terminal	5Floor door ter...	Connected	1005	172.16.10.2	AP-VAC50		2011-07-29 17:08:50	
4	The main entrance d...	The main entran...	Connected	Required setting	172.16.10.3	AP-VAC100		2011-07-29 17:08:50	

Page 1 of 1 Total: 4

AddPac Copyright © 2011 AddPac Technology, Inc.

DACM (Door Access Control Manager)

Access Control Group Management

The screenshot shows a web browser window displaying the 'Door Access Control System' interface. The address bar shows the URL '172.16.1.19/dacm/accessGroupList'. The page title is 'Door Access Control System'. A notification banner at the top right indicates 'Access control setting changed' and provides instructions to apply settings. The navigation menu includes 'Home', 'User and Terminal', 'Access Control', 'Card', and 'Log and Report'. The main content area is titled 'Access Control Group' and includes a brief description: 'You can define a new Access Control Group with one or more terminals, users and schedule policy. Also, you can adjust priority of access control group using up/down arrow (or mouse drag/drop)'. A table lists existing groups with columns for Group Name, Description, Schedule Policy, Date Created, Modify, and Delete. The table contains three rows: '3floor door', 'job policy', and 'default group'. A 'Add a Access Control Group' button is located above the table.

Group Name	Description	Schedule Policy	Date Created	Modify	Delete
3floor door		All Allow	2011-06-28 11:37:13		
job policy	job policy access group	working day	2011-07-04 17:06:47		
default group	default access group	All Allow	2011-06-28 11:37:13		

DACM (Door Access Control Manager)

Configuration Download to Terminal

Door Access Control System

Access control setting changed
To apply setting, click [here](#) to transmitting to terminal.

Help | Logout
Administrator

Home User and Terminal Access Control Card Log and Report

Terminal Sync.

Synchronize user, access group and schedule policy with selected terminals.
Default checked terminals have updated configurations need to be synchronized.

<input checked="" type="checkbox"/>	Terminal Name	IP Address	Connection Status	Sync Status
<input checked="" type="checkbox"/>	2floor door terminal	172.16.10.4	Connected	Not yet synchronized
<input checked="" type="checkbox"/>	3floor door terminal	172.16.10.1	Connected	Not yet synchronized
<input checked="" type="checkbox"/>	5floor door terminal	172.16.10.2	Connected	Not yet synchronized
<input checked="" type="checkbox"/>	The main entrance door	172.16.10.3	Connected	Not yet synchronized

To synchronize with selected terminal above, select 'Sync' button below. Select 'Cancel' button to cancel.

AddPac Copyright © 2011 AddPac Technology, Inc.

DACM (Door Access Control Manager)

RF Card Management

Door Access Control System

Access control setting changed
To apply setting, click [here](#) to transmitting to terminal.

Help | Logout
Administrator

Home User and Terminal Access Control Card Log and Report

Card List

Display registered card list. Also, you can register a new card or modify/delete selected card(s).

Search List: All card Search

Serial Number	Extension	Username	Status	Description	Date Created	Modify	Delete
1 4000238	1008	Kwon hyojun	<input checked="" type="checkbox"/> Specified	Temporary cards are issued.	2011-07-08 15:59:03		
2 123456789			<input type="checkbox"/> Unspecified		2011-07-22 16:17:04		

Page 1 of 1 Total: 2

AddPac Copyright © 2011 AddPac Technology, Inc.

DACM (Door Access Control Manager)

Access Log Management

Door Access Control System

Access control setting changed
To apply setting, click [here](#) to transmitting to terminal.

Help | Logout
Administrator

Home User and Terminal Access Control Card Log and Report

Event Log

Display various event log with search conditions(user, datetime, terminal registration..).

Duration : 11-07-10 ~ 11-08-09

User Extension Number :

Event Level : Error

Search Reset

	Time	Level	User Extension	Event
1	2011-07-15 10:27:27	Warning	1000	authentication failure
2	2011-07-15 11:25:27	Notice	1000	registration success
3	2011-07-15 12:21:27	Notice	1200	registration success
4	2011-07-16 09:27:27	Information	1201	door opened
5	2011-07-16 11:27:27	Information	1007	registration success
6	2011-07-16 17:12:00	Notice		security profile downloading completed
7	2011-07-17 18:00:00	Notice		system started

Page 1 of 1 Total: 7

AddPac Copyright © 2011 AddPac Technology, Inc.



AP-ACS2000 Open API

Open API

Open API for 3'rd Party Management System

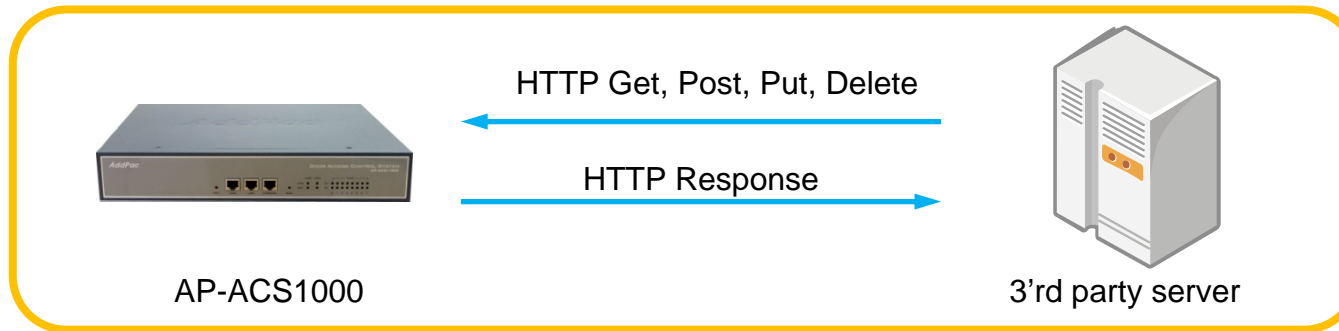

- HTTP based RESTful Open API for Door Access Management
- XML based Flexible and Expandable Message Contents
- Provides More than 40 APIs as Bellow
 - user_list(GET), user(GET, POST, PUT, DELETE), ...
 - terminal_list(GET), terminal(GET, POST, PUT, DELETE), ...
 - access_group(GET, POST, PUT, DELETE), priority (PUT), ...
 - card_list(GET), card(POST, PUT, DELETE), ...
 - schedule_template(GET, POST, PUT, DELETE), rule(GET, POST, PUT, DELETE) ,...



IP Video Door Phones





IP Video Door Phone Comparison Table

Model	AP-VAC200	AP-VAC100	AP-VAC50	AP-VAC20
Service Features				
Duplex (Voice)	Full Duplex	Full Duplex	Full Duplex	Full Duplex
Key Pad	3x4 Key Support	3x4 Key Support	3x4 Key Support	3x4 Key Support
LCD	3.5 Inch	3.5 Inch	2inch LCD	Graphic LCD
RF Card	Support	Support	Support	Support
Fingerprint	N/A	N/A	N/A	N/A
Video Codec	H.264/MPEG4	H.264/MPEG4	H.264/MPEG4	H.264/MPEG4
Voice Codec	G.711	G.711	G.711	G.711
Signaling	H.323/SIP	H.323/SIP	H.323/SIP	H.323/SIP
MIC & Speaker Phone	Support	Support	Support	Support
LAN Port	1	1	1	1
PoE(Optional)	Support	Support	Support	Support

IP Video Door Phone Comparison Table

Model	AP-VAC150	AP-VAC80
Service Features		
Duplex (Voice)	Full Duplex	Full Duplex
Key Pad	Touch Screen based Key Support	Touch Screen based Key Support
LCD	5 Inch LCD	5 inch LCD
RF Card	Support	Support
Fingerprint	Support	N/A
Video Codec	H.264/MPEG4/H.263	H.264/MPEG4/H.263
Voice Codec	G.711	G.711
Signaling	H.323/SIP	H.323/SIP
MIC & Speaker Phone	Support	Support
LAN Port	1	1
PoE(Optional)	Support	Support

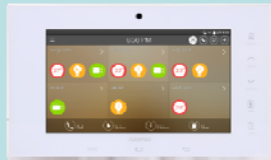
Smart IP Wall PAD Comparison Table

Model	AP-VWP100	AP-VWP90	AP-VWP80	AP-VWP50
Service Features				
Duplex (Voice)	Full Duplex	Full Duplex	Full Duplex	Full Duplex
LCD	7 Inch	7 Inch	7 Inch	5 Inch
Touch Screen	Support	Support	Support	Support
Camera(Optional)	SD(VGA)	SD(VGA)	SD(VGA)	SD(VGA)
Video Codec	SD, H.264/MPEG4/H.263	SD, H.264/MPEG4/H.263	SD, H.264/MPEG4/H.263	SD, H.264/MPEG4/H.263
Voice Codec	G.722, G.711, G.726	G.722, G.711, G.726	G.722, G.711, G.726	G.722, G.711, G.726
Signaling	H.323/SIP	H.323/SIP	H.323/SIP	H.323/SIP
MIC & Speaker Phone	Support	Support	Support	Support
LAN Port	1	1	1	1
Camera(Optional)	SD(VGA)	SD(VGA)	SD(VGA)	SD(VGA)
Analog Door Phone Interface (option)	SD	SD	SD	SD
PSTN Line (Option)	Support	Support	Support	Support
PoE(Optional)	Support	Support	Support	Support



Thank you!

AddPac Technology Co., Ltd.
Sales and Marketing

Phone +82.2.568.3848 (KOREA)

FAX +82.2.568.3847 (KOREA)

E-mail : sales@addpac.com