

AP-VAC80

IP Video Door Phone

High Performance IP Video Door Phone Solution

Preliminary Product Overview

(Without notice, following described technical spec. can be changed)



AddPac

AddPac Technology

2014, Sales and Marketing

www.addpac.com

Contents

- Product Overview
- Product Highlights
- Hardware Specification
- Software Service
- Video Service & Features
- Audio & Voice Service and Features
- Smart Web Manager
- Application Area
- Ordering Information



Product Overview

AP-VAC80 IP Video Door Phone

- High Performance IP Video Door Phone Solution
- Video Camera, Touch Screen TFT Color LCD, Internal MIC & Speaker
- High Quality 5 Inch LCD, 800 x 480 Video Resolution
- SIP VoIP Signaling Stack Embedded
- High-performance Video/Voice Codec Support
 - H.264/MPEG4, G.711, etc
- One(1) 10/100Mbps Fast Ethernet
- PoE(Power over Ethernet) Support
- High Quality Speaker Phone Features
- Powerful Acoustic Echo Canceller Chip Embedded
- Powerful Network Protocols (PPPoE, DHCP, Static Routing, etc)
- Firmware Upgradeable Architecture
- Advanced Voice QoS Mechanism

Product Highlights

AP-VAC80 IP Video Door Phone

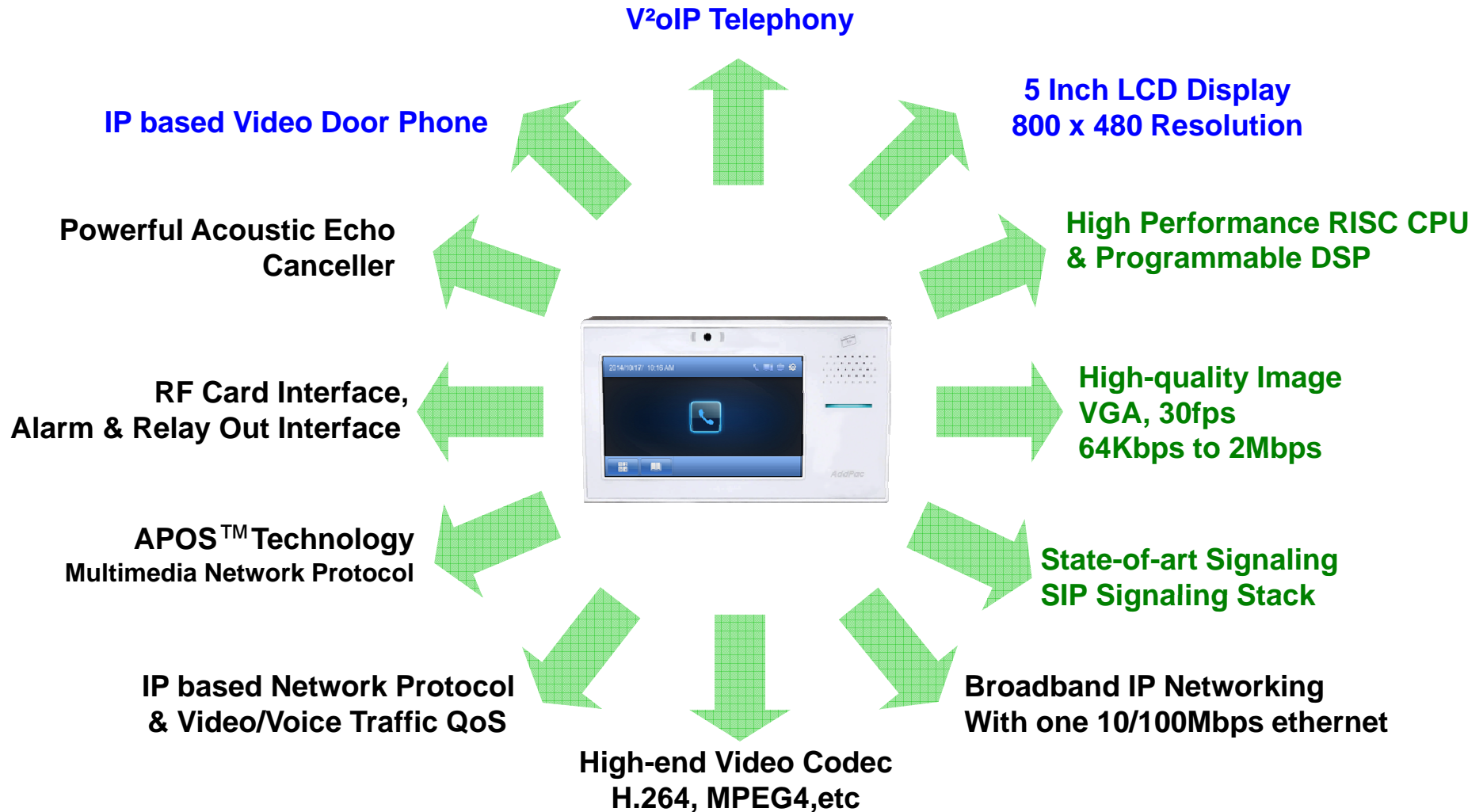

AddPac

www.addpac.com

Multimedia Service

AP-VAC80 IP Video Door Phone

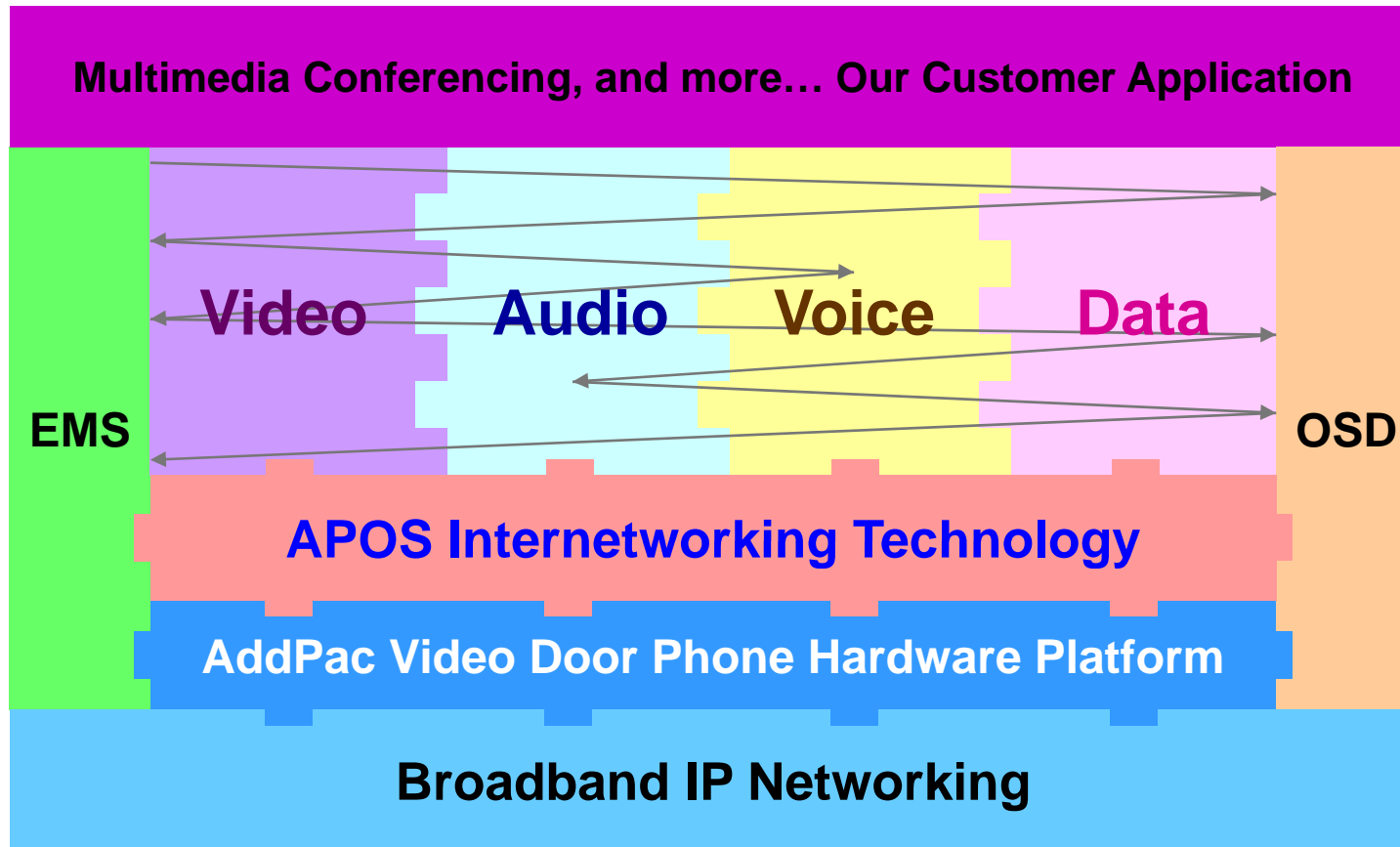

- APOS : AddPac Internetworking Operating System
- OSD : On- Screen Display
- EMS : Element Management System

Hardware Specification

AP-VAC80 IP Video Door Phone

RISC
CPU

High-end
DSP

- RISC+DSP Microprocessor Computing Power
- Audio and Voice Interface
 - Internal MIC
 - Internal Speaker
- Video Camera Interface
- TFT Color LCD Interface
 - 5 Inch LCD, 800 x 480 Video Resolution
- Network Interface
 - One(1) 10/100Mbps Fast Ethernet
- RF Card Interface
- Alarm & Relay Out Interface (door open, etc)
- RS232/RS485 Interface
- Power Supply
 - Power over Ethernet (Option)
 - External Power Supply

Hardware Specification

AP-VAC80 IP Video Door Phone

RISC
CPU

High-end
DSP

- **Acoustic Echo Canceller**
 - Full-duplex operation during double-talk situations
 - One channel AEC, one channel LEC up to 256ms shared
 - Cancels echoes with up to 10dB echo return
 - Advanced noise reduction(up to 20dB)
- **Speaker**
 - Impedance : 8 +/-15%ohm at 1kHz, 1.0 Vrms
 - Sound Pressure : 90 +/- 3dB at 0.1W/10 CM
at 800Hz, 1.0kHz, 1.2kHz, 1.5kHz
 - Resonance Level : 550Hz +/- 20%Hz at Fo Hz, 1.0Vrms
 - Frequency Range : Fo Hz ~20kHz
 - Input Power : Normal : 1.0 W, Max : 2.0W
- **Audio Amplifier**
 - 1-W BTL Output(5V, 0.11 % THD+N)
 - Uncompensated Gains of 2 to 20 (BTL Mode)
 - Thermal and Shot-circuit Protection
 - High Supply Ripple Rejection Ratio
- **PoE(Power over Ethernet)**
 - IEEE802.3af compliant
 - Input voltage range 36V to 57V
 - Short-circuit Protection

Hardware Specification

AP-VAC80 IP Video Door Phone

RISC
CPU

High-end
DSP

- **LCD Controller**
 - One-Chip Solution for TFT-LCD
 - Hardware On-Screen Display (OSD)
 - Support resolution up to 240xRGBx320
 - Up to 24-bit RGB888 Digital Interface
 - Resize Function (x 1/16, x8)
 - BT.60/BT.66 Digital YCbCr 4:2:2(8-/16-bit) Interface
- **Camera**
 - High Sensitivity for low-light operation
 - Output support for Raw RGB, RGB, and YCrCb format
 - Image Size : VGA, QVGA, and any size scaling down from CIF to 40x30
 - Support AEC, AGC,AWB, ABF, ABLC
 - Saturation Level, Edge Enhancement Level, De-noise level Auto adjust

Hardware Specification

AP-VAC80 IP Video Door Phone

RISC
CPU

High-end
DSP

- RF Card Sensor
 - Protocol Supported
 - ISO14443A/B all bit rates
 - > 106,212,424 and 848 kbps
 - Compatible to MiFare Classic
 - ISO15693 all modes
 - > 1.65/6.6 & 26.5 kbps
 - > Uplink 1 & 2 sub-carrier
 - Receiver
 - Rx Sensitivity down to 1mVrms
 - Rx Automatic Gain Control
 - Accept external baseband signal from
 - external circuitry for frame level processing
 - Integrated signal strength indicator (SSI)
 - On-Chip Framing handler for supported standard
 - Transmitter
 - Typical proximity operating distance up to 100mm.
 - Software configurable modulation index
 - Maximum driving current up to 200 mA/PIN @ 5V
 - Accept external baseband signal for RF modulation
 - Wide Transmitter driver supply range from 2.7~7.0V

Hardware Specification

AP-VAC80 IP Video Door Phone

RISC
CPU

High-end
DSP

Front Side



Hardware Specification

AP-VAC80 IP Video Door Phone

RISC
CPU

High-end
DSP

Back Side

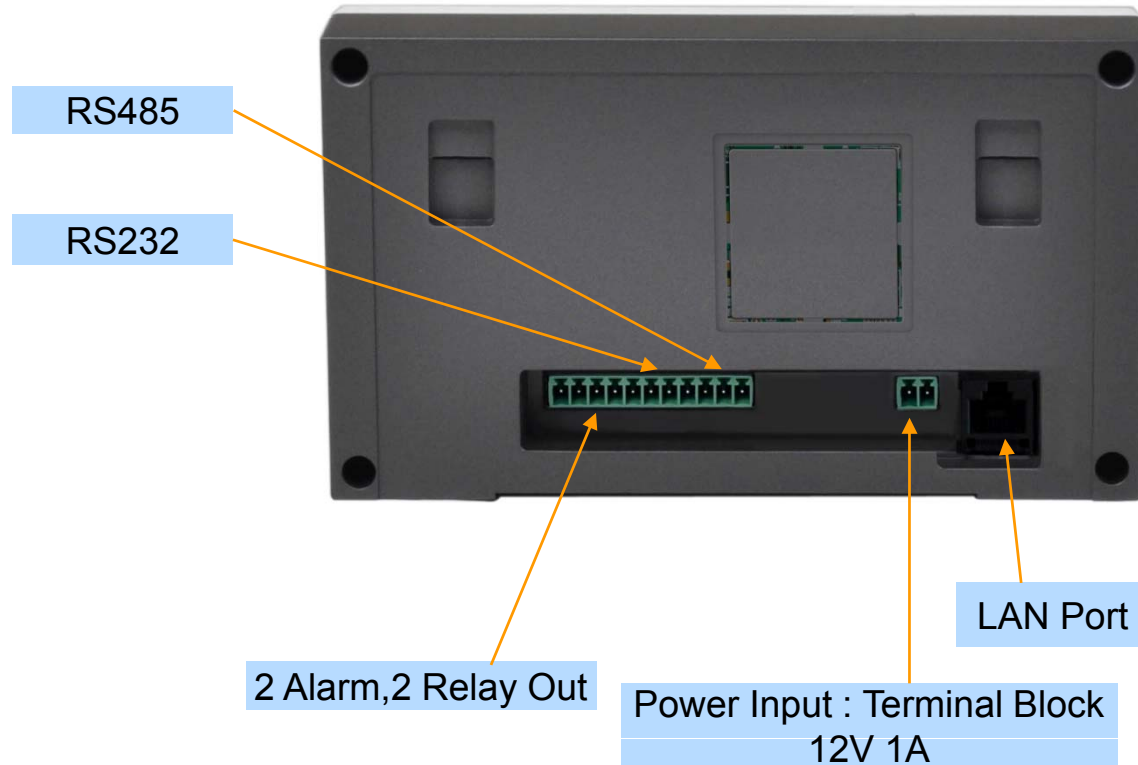

Hardware Specification

AP-VAC80 IP Video Door Phone

RISC
CPU

High-end
DSP

Power Supply

Terminal Block



12V 1A Power Adaptor

Example



Software Service

AP-VAC80 IP Video Door Phone

- **Built-in AddPac APOS Internetworking Software**
 - Scalability, Functionality, and Stability Features
 - Video Traffic QoS Control
- **Programmable Video, Audio, and Voice Services**
 - Video Codes, Audio, and Voice Codec
- **Firmware Upgradeable DSP Architecture**
- **OSD (On-screen Display) Function Support**
- **Industry Standard IP based Network Protocol Features**

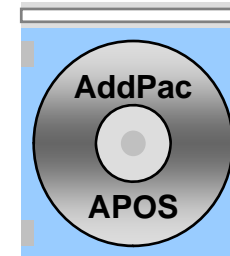

Video Service and Features

AP-VAC80 IP Video Door Phone

- **High-performance Video Codec Support**
 - H.264, etc
- **Image Resolution Support**
 - Local Display : 160 x 120
 - Remote Display : 240 x 160
 - Video Encoding : VGA(640x480), QVGA(320x240)
- **Up to 30fps with VGA Resolution**
- **128Kbps to 2Mbps Operating Video Traffic Bandwidth**
- **Rate Control for Video Traffic QoS**
 - Ensuring Optimized Quality
 - Frame Rate with Limited Bandwidth
- **High-end Error Resilient Against Various Packet Error**

Audio & Voice Service and Features

AP-VAC80 IP Video Door Phone

- **VoIP based Signaling Protocol Support**
 - SIP Signaling Protocol Stack
- **High-performance Audio & Voice Codec Support**
 - G.711, G.726 Audio Codec
- **Enhanced QoS Management Features for Voice Traffics**



Smart Web Manager (Example)

Smart Web Manager

AP-VAC80 IP Video Door Phone

- Main Screen
- System
 - Language
 - LAN Setup
 - DACS
 - Display
 - File Browser
- SIP Call & Media
 - SIP (Session Initiation Protocol)
 - Speed Dial
 - Media
- Miscellaneous
 - Door Control and Test
 - Network Test

Smart Web Manager : Main Screen

AP-VAC80 IP Video Door Phone

Initialization Rebooting Save Telnet

Smart Web Manager
www.addpac.com

System

- Language
- LAN Setup
- DACS
- Display Manager
- File Browser

Call & Media

- Server SIP
- Speed Dial
- Media

Miscellaneous

- Ping
- Door Open

Configure Language

한국어

English

✓ Apply

Information

AddPac Technology
Model : VAC50_G2
DACS : (0)
DACS Registration : Fail
SIP : 172.17.250.250(5060)

Description

Choose the basic language to be applied. English is set at default.

Menu Tree

Output Screen after
Menu Select

System Information and
Help Message

Smart Web Manager : SIP configuration

AP-VAC80 IP Video Door Phone

SIP (Session Initiation Protocol)

SIP server check if exist.

Use SIP Server

Yes No

SIP Basic Information Display

Primary SIP Server

172.17.250.250

5060

Server address and Port (default 5060)

Secondary SIP Server

5060

Server address and Port (default 5060)

Local Domain Name

(SIP userpart of authentication)

SIP Signaling Port

5060

(default 5060, between 1 to 65535)

Register Expiration

60

(in seconds, default 60, between 10 to 86400)

Session Re-Fresh

INVITE UPDATE

Session Expire Time

1800

(in seconds, default 1800, between 30 to 86400, 0 = disable)

Min-SE

1800

(in seconds, default 1800, between 30 to 86400)

Extension

1020

Number, Password

Extension

Telephone Line Number and Password Configuration Same Information is used when DACS is connected

AddPac

AP-VAC80 IP Video Door Phone

Application Area

- Point-to-Point Application (Simple Application)
- Point-to-Multipoint Application
 - All AddPac Solution
(Call Manager + Door Access Control Server)
 - Legacy PBX Environment
 - Legacy IP-PBX Environment

Point-to-Point Connection (Simple Appl.)

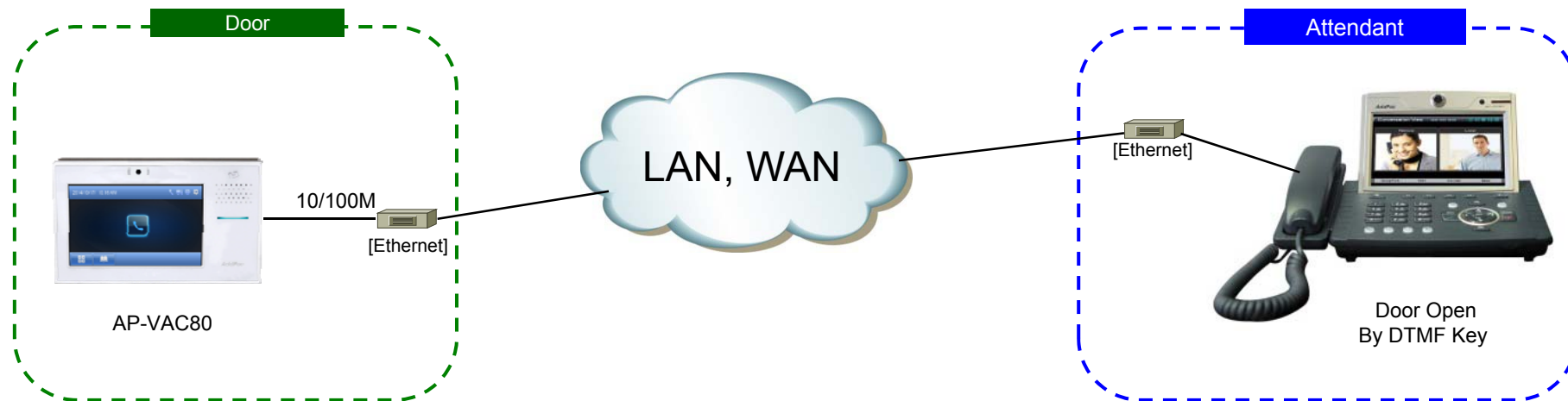

Integrated Door Access Control and Call Control (All AddPac Solution)

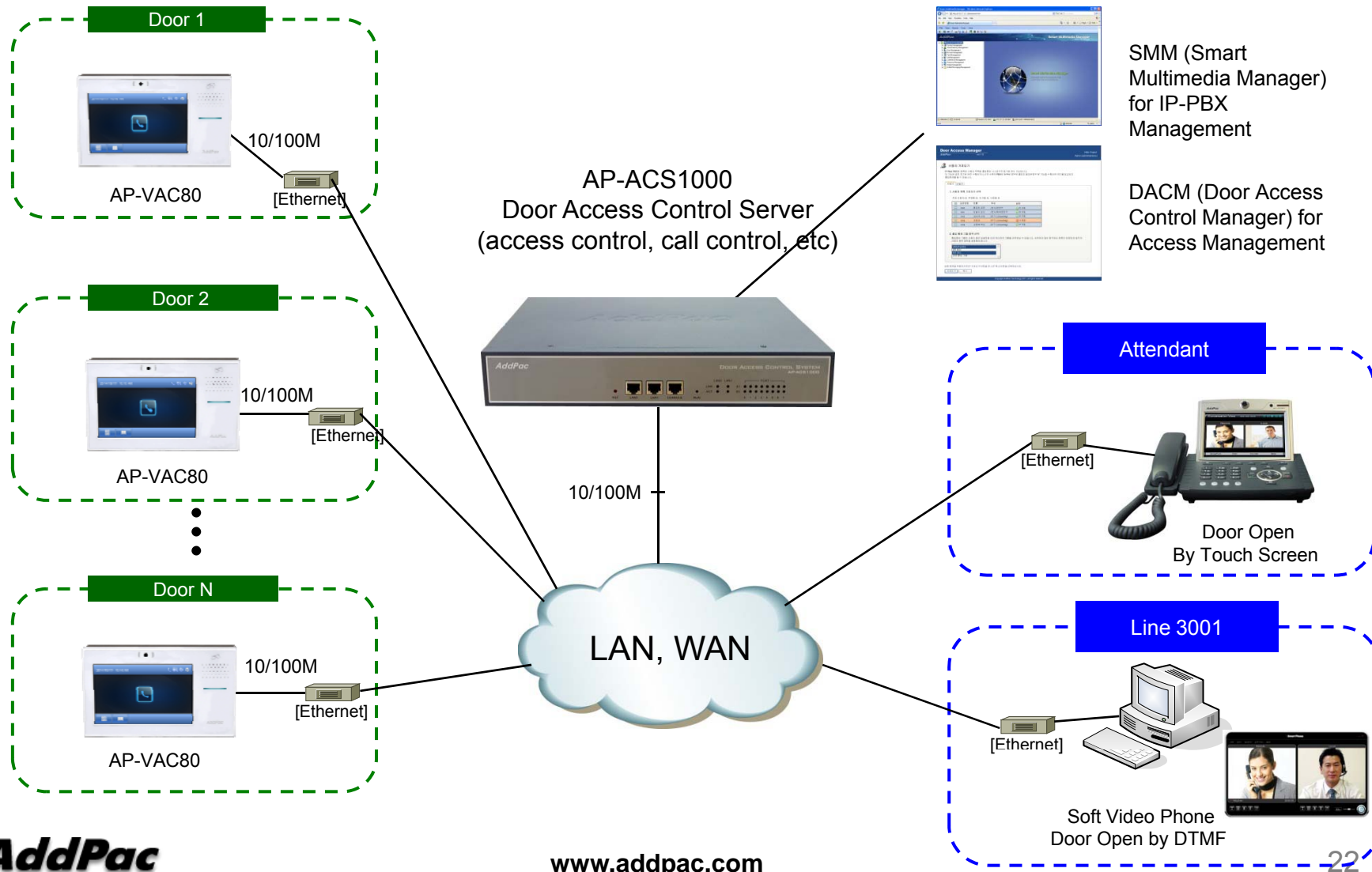

Legacy PBX Environment

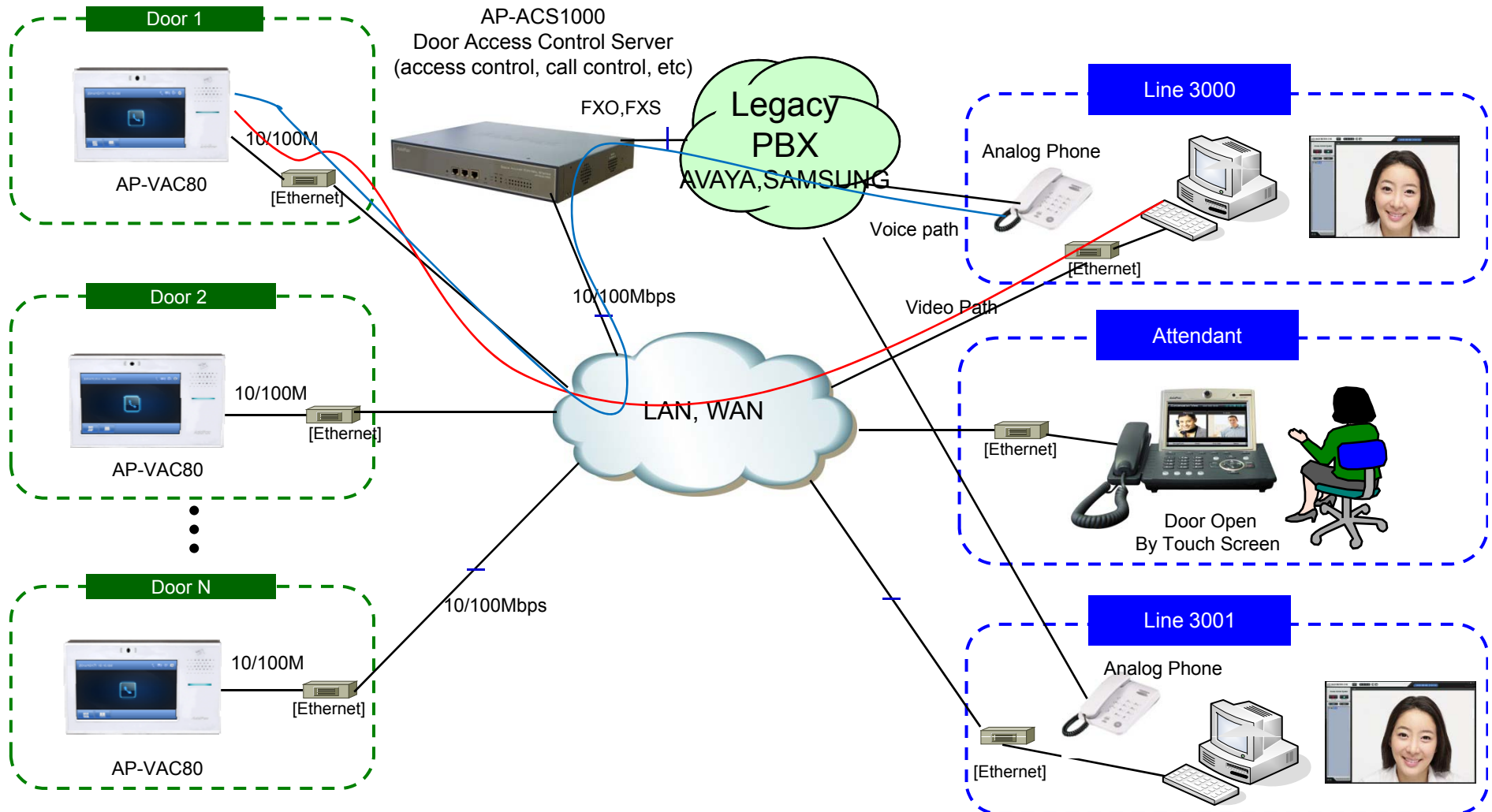

Legacy IP-PBX Environment

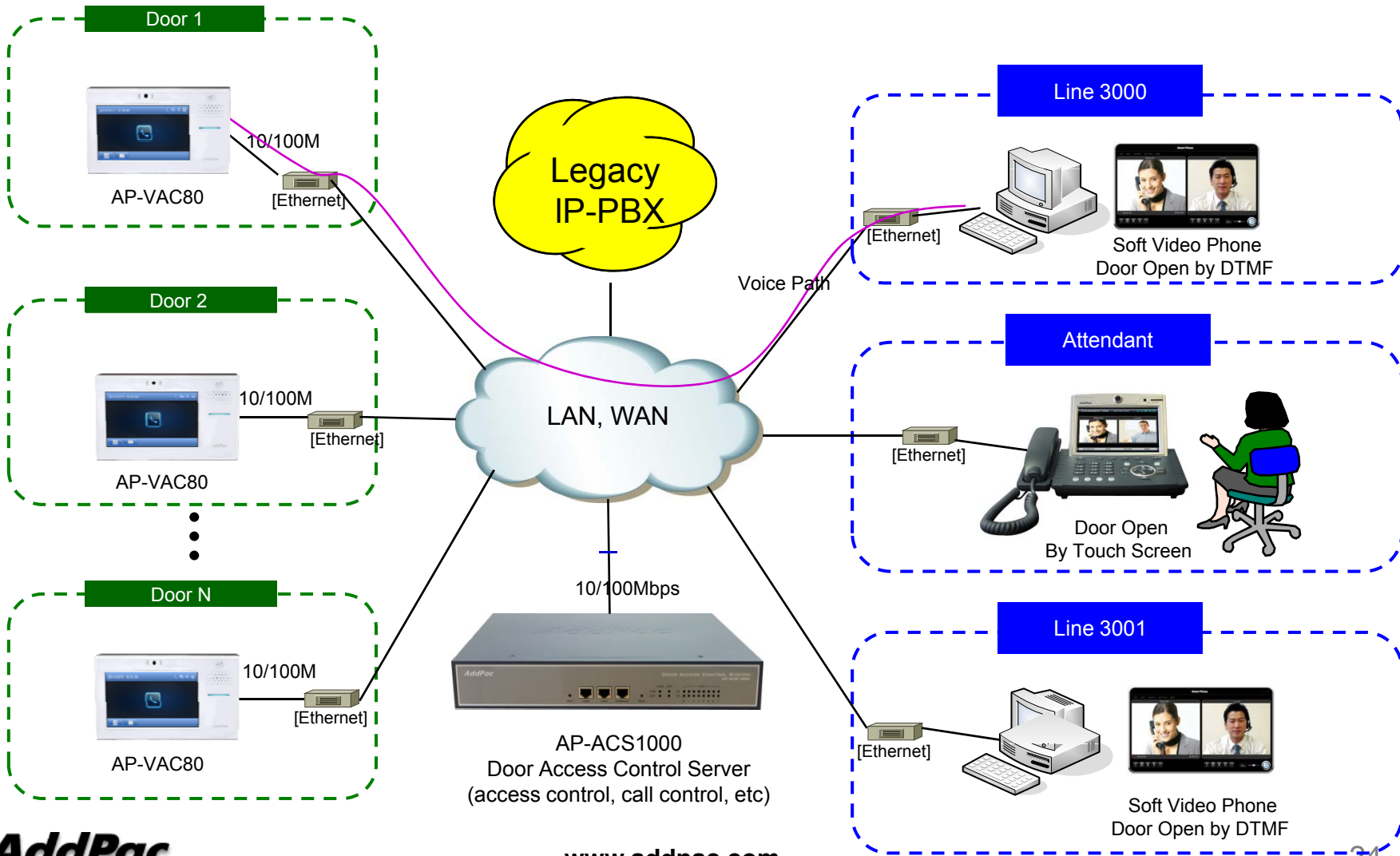

Ordering Information

- **AP-VAC80 IP Video Door Phone Hardware**
 - AP-VAC80 Video Phone Main Body
 - RISC Microprocessor with High-end Programmable DSP Architecture
 - 5 Inch LCD, Built In Camera, Side Light
 - Internal MIC, Internal Speaker
 - 1-ports 10/100Mbps Fast Ethernet
 - PoE Interface
 - Including Network Cable Set & Ext. Power Supply, etc.
- **Built-in APOS Internetworking Software for AP-VAC80**
- **Including 1 Year Hardware Warranty**
- **Product Documents**
 - Install and Operation Guide (PDF)
- **Pricing**
 - AddPac Technology Regional Sales Manager
 - Authorized Sales and Marketing Representatives
 - Please Contact www.addpac.com



Thank you!

AddPac Technology Co., Ltd.
Sales and Marketing

Phone +82.2.568.3848 (KOREA)

FAX +82.2.568.3847 (KOREA)

E-mail sales@addpac.com