

AP-TAC300 Time Attendance Door Access Controller

High Performance Time & Attendance Door Access Controller Solution



AddPac

AddPac Technology

2014, Sales and Marketing

www.addpac.com

Contents

- Product Overview
- Product Highlights
- Hardware Specification
- Software Service
- Smart Web Manager
- Door Access Control Manager
- Time and Attendance Web Manager
- Application Network Diagram
- Ordering Information

Product Overview

AP-TAC300 Time & Attendance Door Access Controller

- Smart Time and Attendance Access Controller Solution
- High Performance Fingerprint Recognition Solution
- TFT Color LCD, Internal Speaker
- High Quality 3.5 Inch LCD, 320 x 240 Video Resolution
- RF Card Support
- One(1) 10/100Mbps Fast Ethernet
- PoE(Power over Ethernet) Support
- Powerful Network Protocols (PPPoE, DHCP, Static Routing, etc)
- Embedded Web based Management
- Master-Slave Mode based Multi-Terminal Support
- Smart Web Manager Support (PC, Tab, Smart Phone, etc)
- Smart Door Access Control Web Manager Support
- Smart Time and Attendance Web Manager Support
- Diecasting Still Chassis
- Firmware Upgradeable Architecture

Product Highlights

AP-TAC300 Time & Attendance Door Access Controller

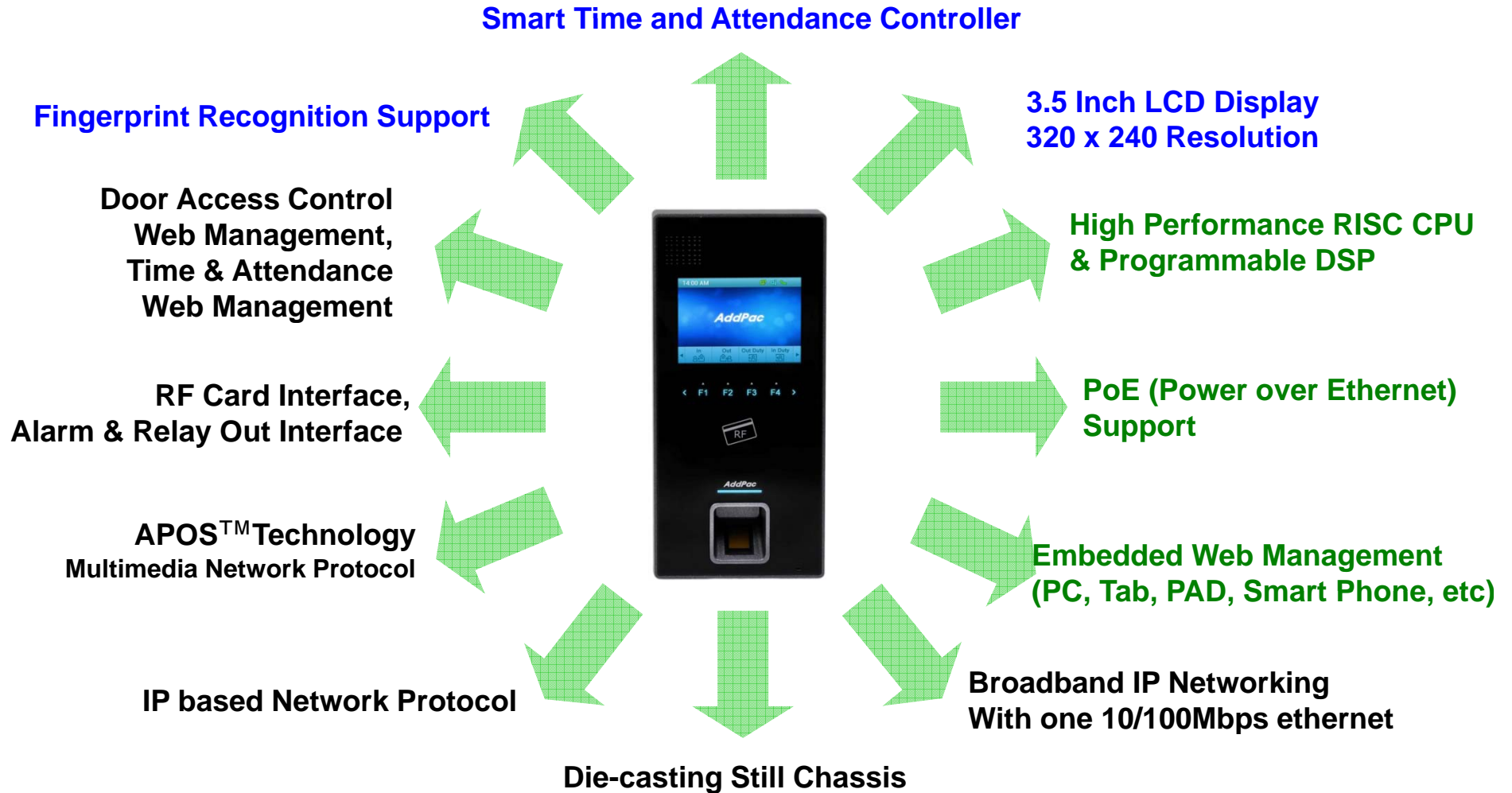

Multimedia Service

AP-TAC300 Time & Attendance Door Access Controller

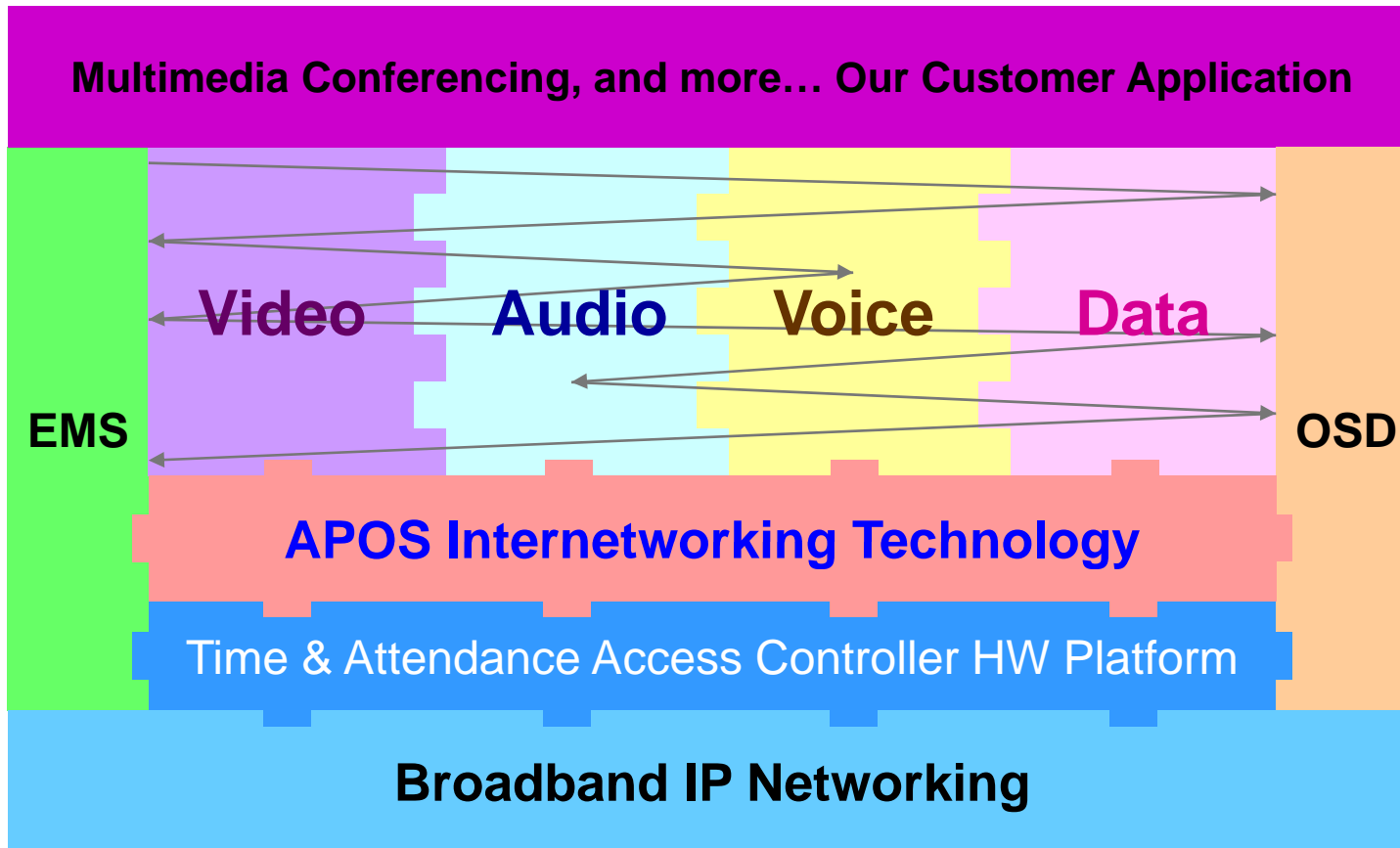

- APOS : AddPac Internetworking Operating System
- OSD : On- Screen Display
- EMS : Element Management System

Hardware Specification

AP-TAC300 Time & Attendance Door Access Controller

RISC
CPU

High-end
DSP

- RISC+DSP Microprocessor Computing Power
- Audio and Voice Interface
 - Internal Speaker
- TFT Color LCD Interface
 - 3.5 Inch LCD, 320 x 240 Video Resolution
- Network Interface
 - One(1) 10/100Mbps Fast Ethernet
- Fingerprint Recognition Interface
- RF Card Interface
- Alarm & Relay Out Interface (door open, etc)
- RS232/RS485 Interface
- STILL Chassis
- Power Supply
 - Power over Ethernet (Option)
 - External Power Supply



Hardware Specification

AP-TAC300 Time & Attendance Door Access Controller

RISC
CPU

High-end
DSP

- **LCD Controller**
 - One-Chip Solution for amorphous TFT-LCD
 - Support resolution up to 240xRGBx320
 - Built-in 172800 bytes internal RAM
 - 6,8,16, and 18-bit RGB Interface
 - Resize Function (x ½, x ¼)
 - On-Chip Power Management System
- **Speaker**
 - Impedance : 8 +-15%ohm at 1kHz, 1.0 Vrms
 - Sound Pressure : 90 +- 3dB at 0.1W/10 CM at 800Hz, 1.0kHz, 1.2kHz, 1.5kHz
 - Resonance Level : 550Hz +- 20%Hz at Fo Hz, 1.0Vrms
 - Frequency Range : Fo Hz ~20kHz
 - Input Power : Normal : 1.0 W, Max : 2.0W
- **Audio Amplifier**
 - 1-W BTL Output(5V, 0.11 % THD+N)
 - Uncompensated Gains of 2 to 20 (BTL Mode)
 - Thermal and Shot-circuit Protection
 - High Supply Ripple Rejection Ratio
- **PoE(Power over Ethernet)**
 - IEEE802.3af compliant,
 - Input voltage range 36V to 57V
 - Short-circuit Protection

Hardware Specification

AP-TAC300 Time & Attendance Door Access Controller

RISC
CPU

High-end
DSP

- RF Card Sensor
 - Protocol Supported
 - ISO14443A/B all bit rates
 - > 106,212,424 and 848 kbps
 - Compatible to MiFare Classic
 - ISO15693 all modes
 - > 1.65/6.6 & 26.5 kbps
 - > Uplink 1 & 2 sub-carrier
 - Receiver
 - Rx Sensitivity down to 1mVrms
 - Rx Automatic Gain Control
 - Accept external baseband signal from external circuitry for frame level processing
 - Integrated signal strength indicator (SSI)
 - On-Chip Framing handler for supported standard
 - Transmitter
 - Typical proximity operating distance up to 100mm.
 - Software configurable modulation index
 - Maximum driving current up to 200 mA/PIN @ 5V
 - Accept external baseband signal for RF modulation
 - Wide Transmitter driver supply range from 2.7~7.0V

RF Card Sensor



Hardware Specification

AP-TAC300 Time & Attendance Door Access Controller

RISC
CPU

High-end
DSP

- Fingerprint Recognition
 - Sensor Type : Capacitive
 - Resolution(dpi) : 508
 - Sensing Area(mm) : 12.8 x18.0
 - Image Size(pixel) : 256 x 360
 - CPU : 400MHz DSP
 - Flash Memory : 4MB
 - ERR : < 0.1%
 - Enrollment Time : 800msec
 - 1:1 Verification Time : 800msec
 - 1:1000 Identification Time : 970msec
 - Template Size : 256~384bytes (configurable, 384bytes default)
 - Template Capacity : 9,000
 - Encryption : 256bit AES



Fingerprint Recognition

Hardware Specification

AP-TASC00 Time & Attendance Door Access Controller

RISC
CPU

High-end
DSP

Front Side

Internal Speaker



TFT LCD Display

Time & Attendance Menu

Function & Direction Key

RF Card Sensor

Status LED

Fingerprint
Recognition

STILL Chassis

AddPac

www.addpac.com

Hardware Specification

AP-TAC300 Time & Attendance Door Access Controller

RISC
CPU

High-end
DSP

Back Side

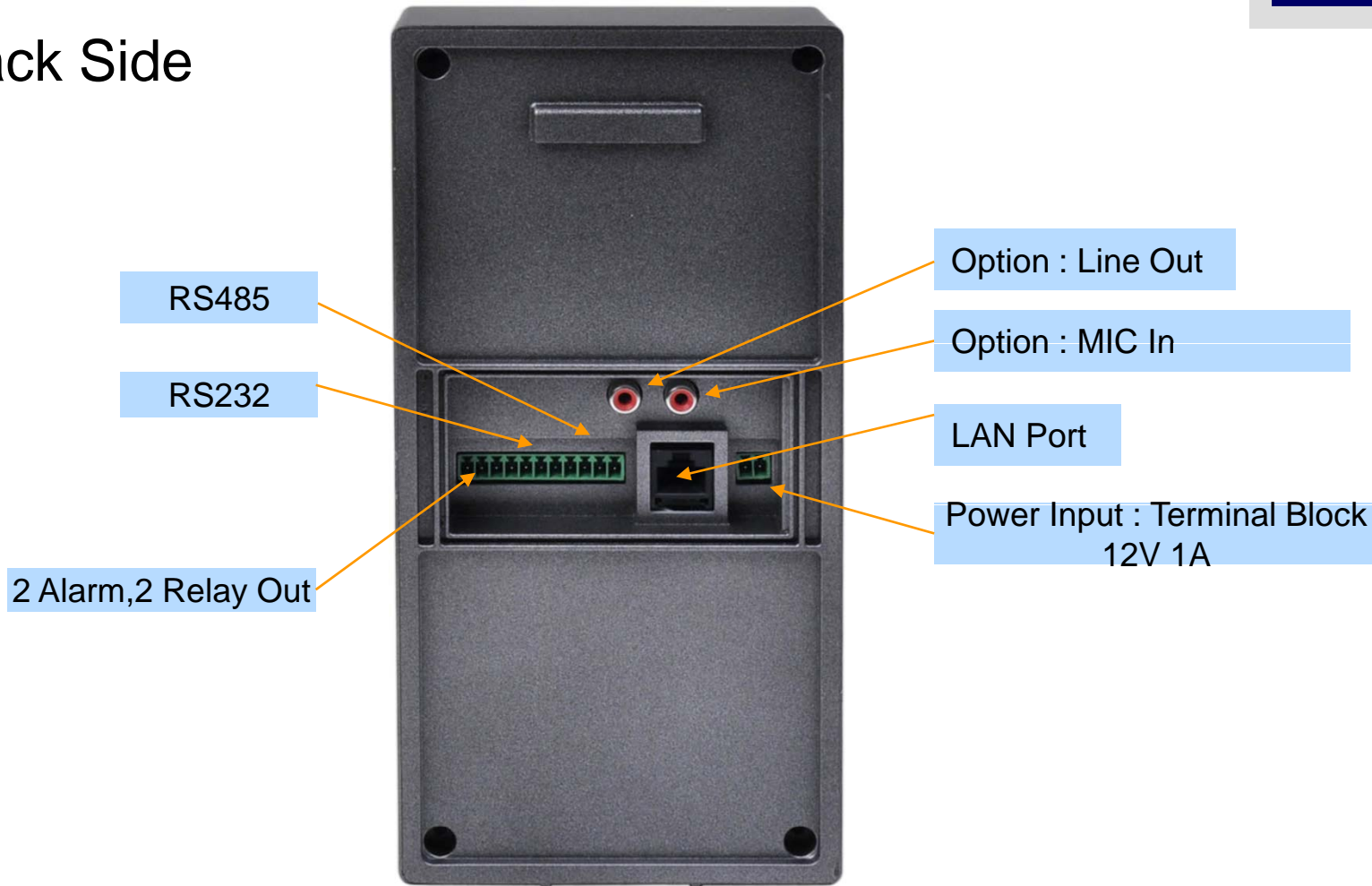

Hardware Specification

AP-TAC300 Time & Attendance Door Access Controller

RISC
CPU

High-end
DSP

Power Supply

Terminal Block



12V 1A Power Adaptor

Example



Software Service

AP-TAC300 Time & Attendance Door Access Controller

- Built-in AddPac APOS Internetworking Software
 - Scalability, Functionality, and Stability Features
- Firmware Upgradeable DSP Architecture
- OSD (On-screen Display) Function Support
- Industry Standard IP based Network Protocol Features
- Embedded Web Server
- Advanced Door Access Control Software

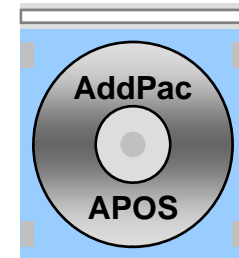



Smart Web Manager (Example)

Smart Web Manager

AP-TAC300 Time & Attendance Door Access Controller

- Main Screen
- System
 - Language
 - LAN Setup
 - DACS
 - Display
 - File Browser
- Miscellaneous
 - Door Control and Test
 - Network Test



Smart Web Manager : Main Screen

AP-TAC300 Time & Attendance Door Access Controller

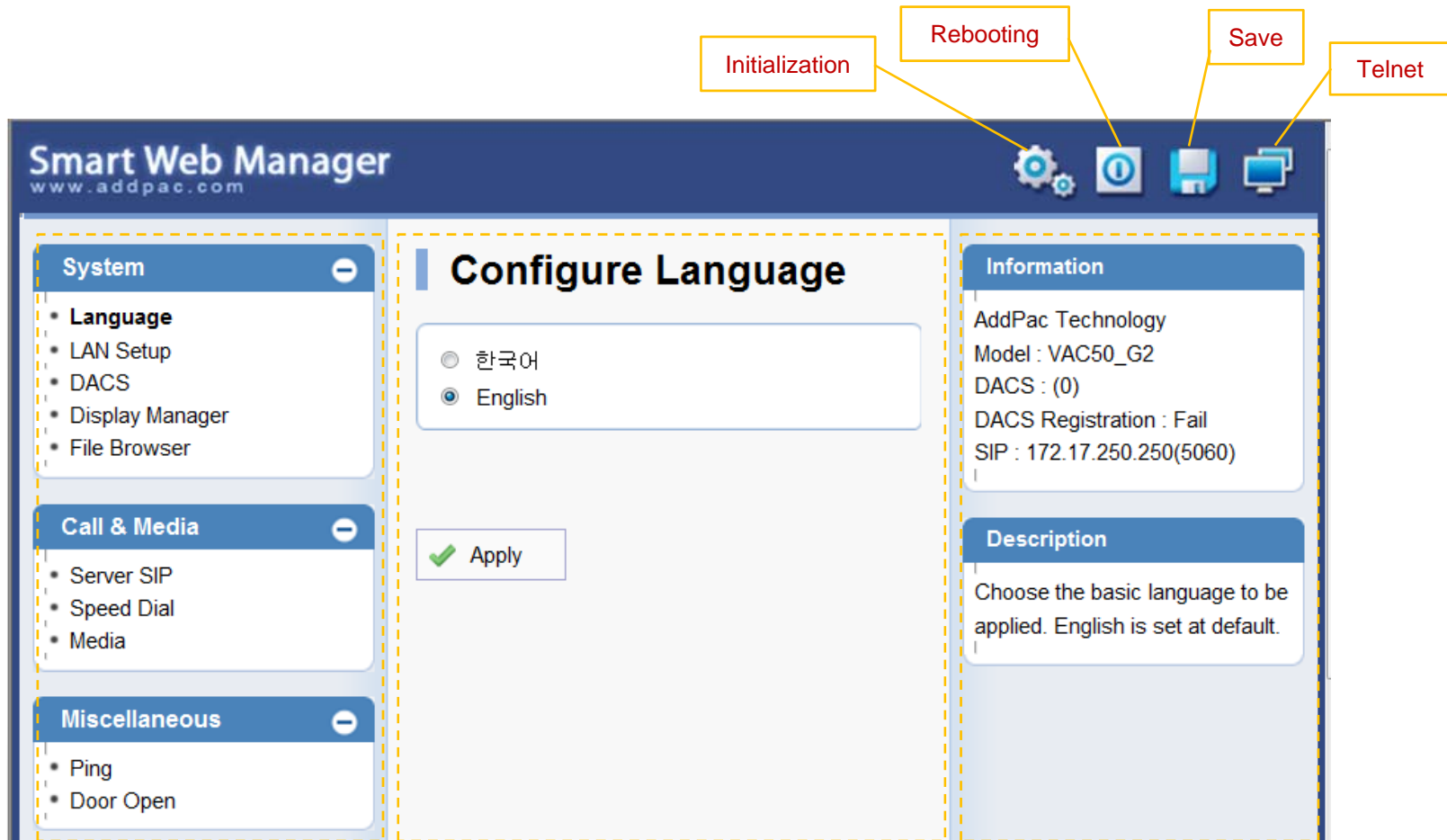

Menu Tree

Output Screen after
Menu Select

System Information and
Help Message



Time & Attendance System Message Flow

Time & Attendance System Message Flow

Registration and KeepAlive

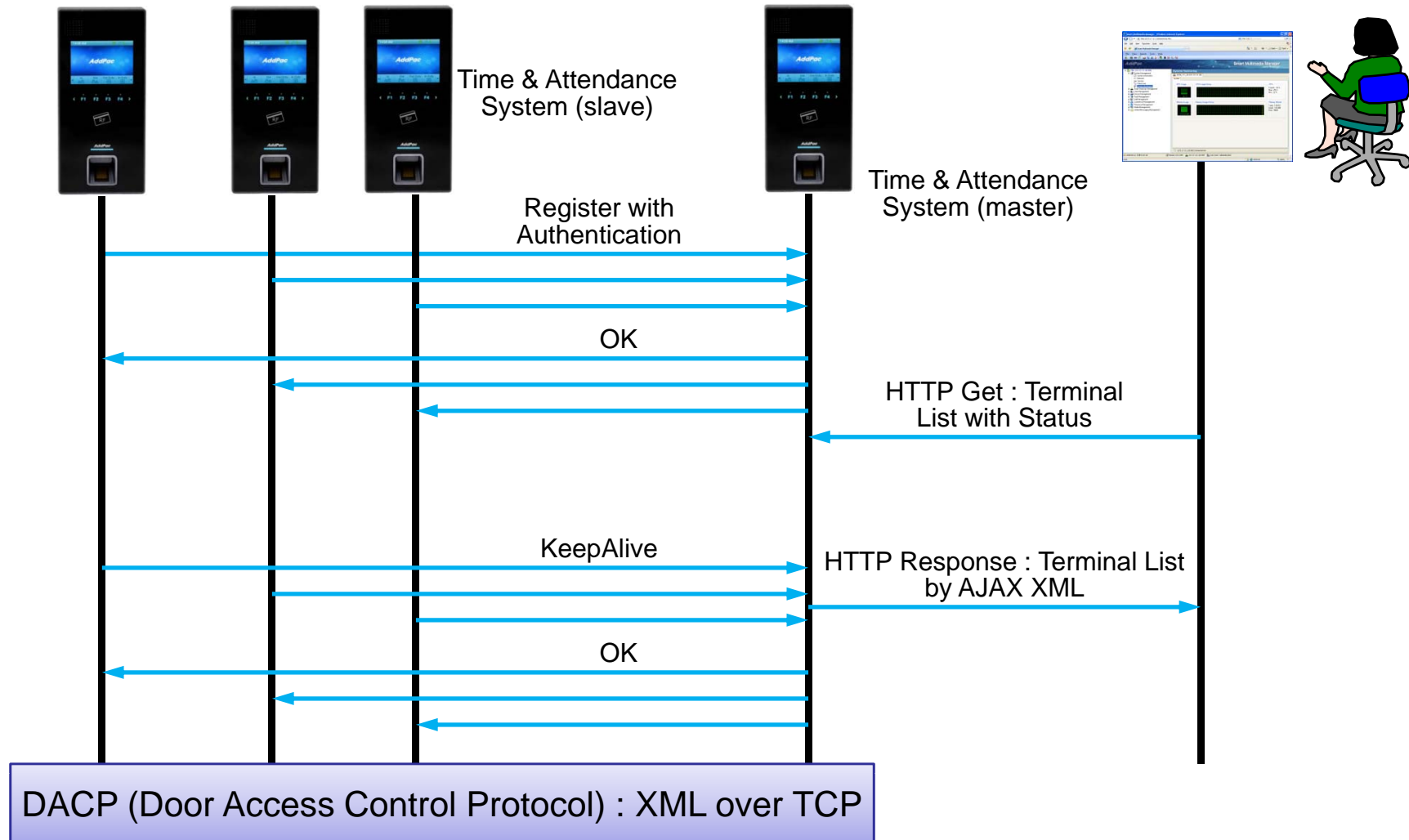

Time & Attendance System Message Flow

Access Privilege and Schedule Download

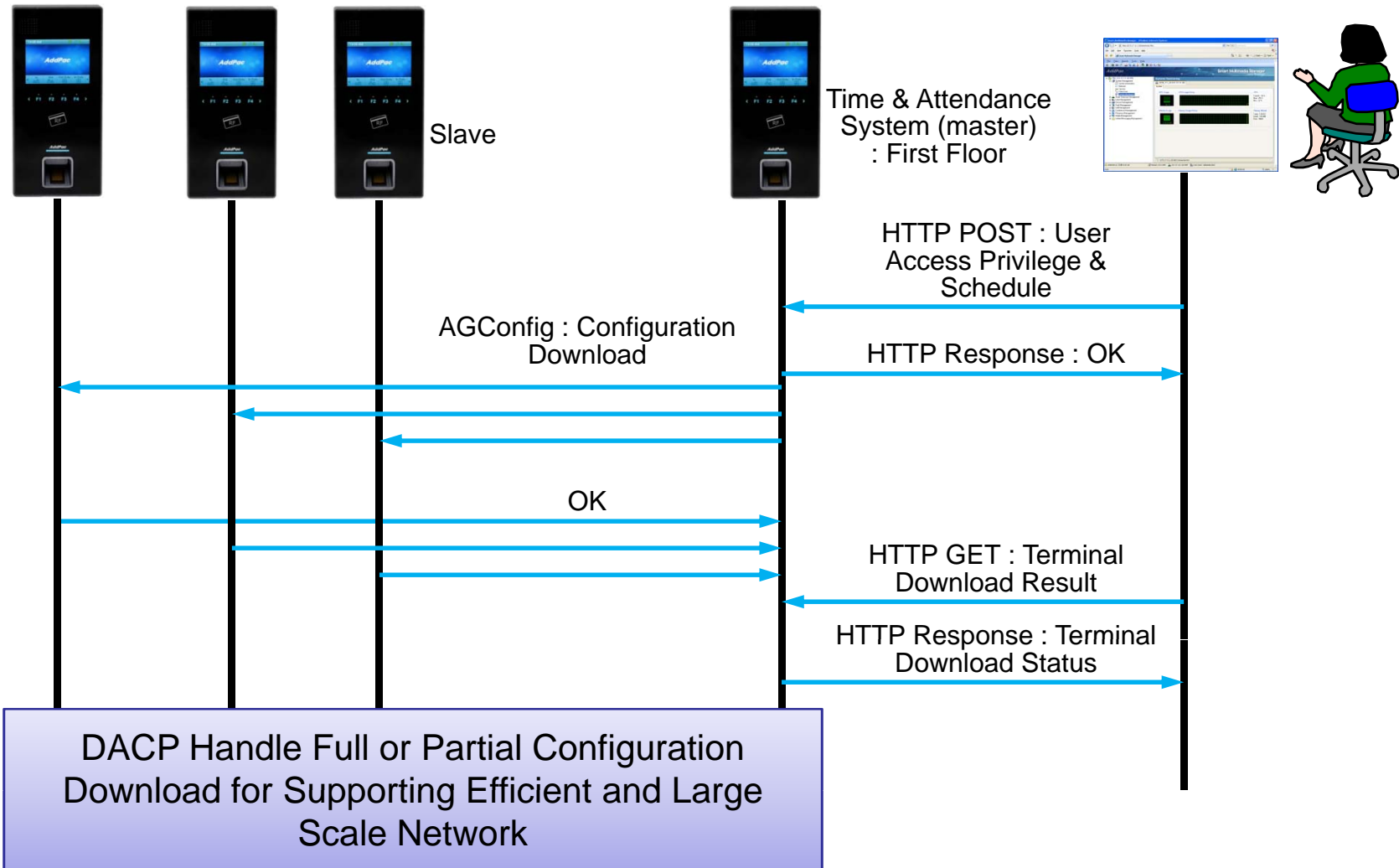

Time & Attendance System Message Flow

RF Card Read/Write and Registration

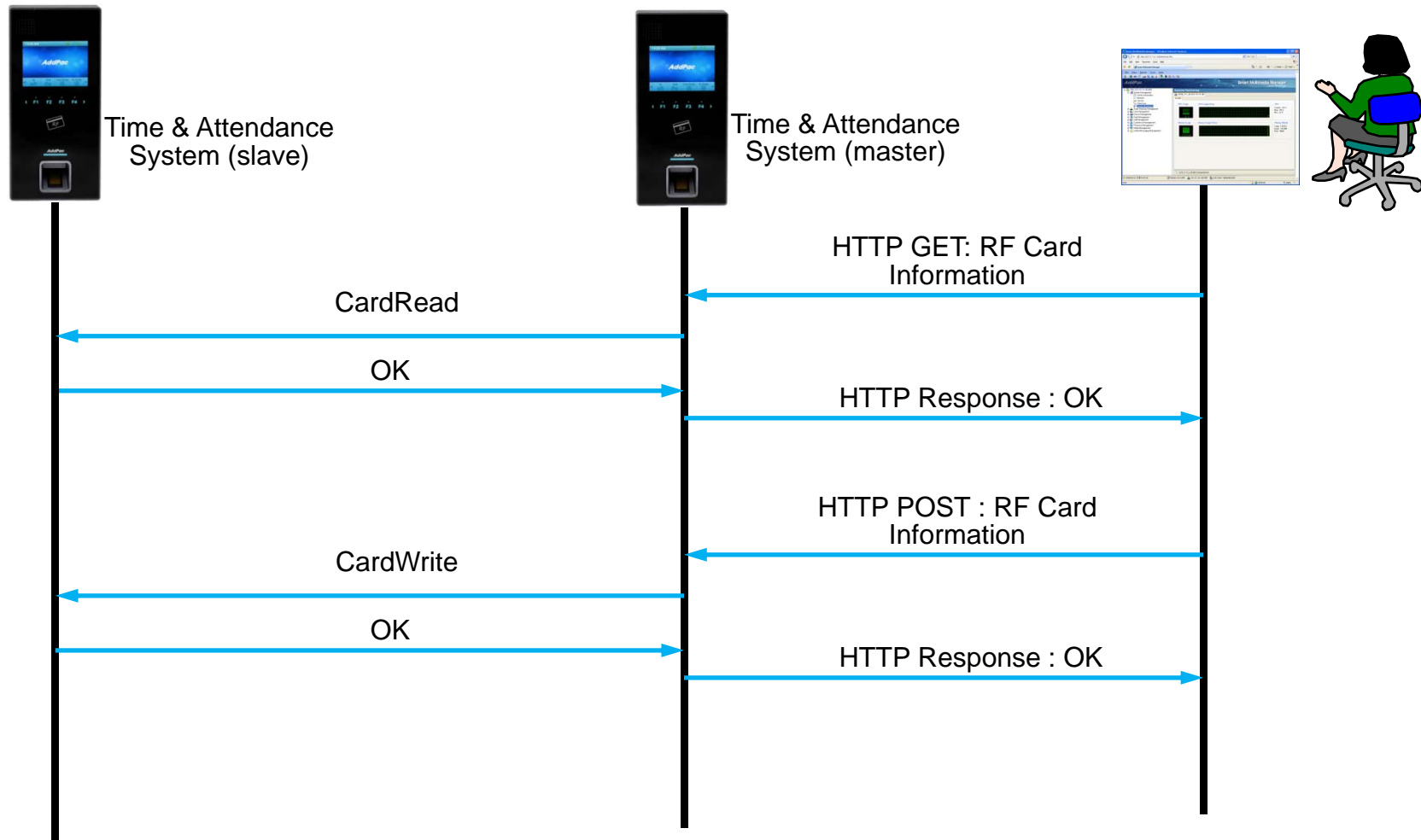

Time & Attendance System Message Flow

Door Open by RF Card

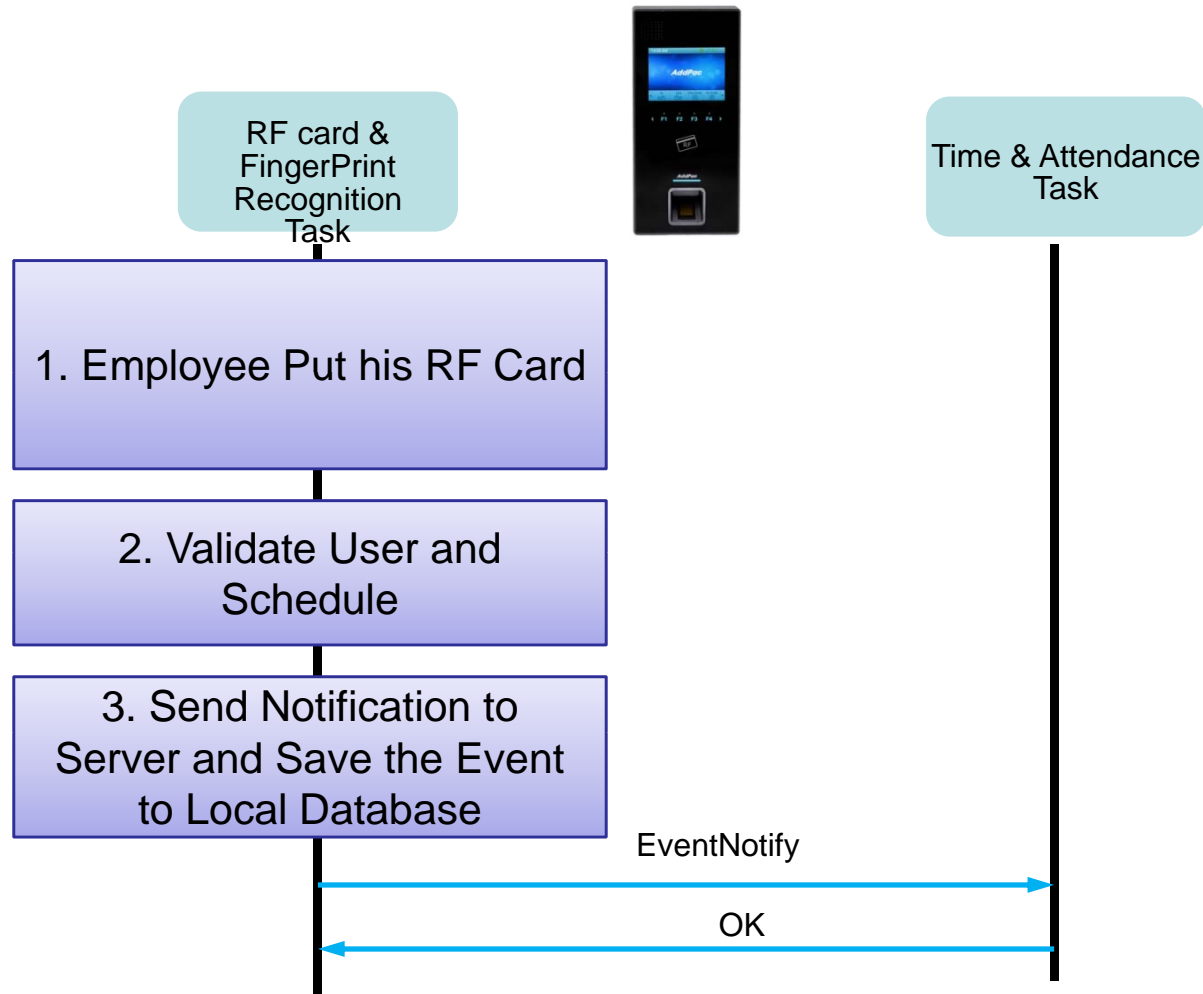



Door Access Control Manager for AP-TAC300

DACS (Door Access Control System)

Login page

The screenshot shows a web browser window with the URL `172.16.1.19/index.php`. The page title is "Door Access Control System". The main content area features the "AddPac Door Access Control System" logo and a login form with fields for "Administrator ID" (containing "root") and "Password" (masked with dots). Below the form are two buttons: "Door Access Control Manager" and "Time and Attendance Manager".

Annotations on the screenshot include:

- A yellow box at the top center containing the text: "You can log on 'Door Access Control Manager' or 'Time and Attendance Manager' if license is valid and administrator have authentication right". A yellow arrow points from this box to the login form.
- A blue box on the left containing the text: "Log on to Door Access Control Management". A blue arrow points from this box to the "Door Access Control Manager" button.
- A blue box on the right containing the text: "Log on to Time and Attendance Management". A blue arrow points from this box to the "Time and Attendance Manager" button.



Door Access Control Web Manager Software (DACM)

DACM (Door Access Control Manager)

Main Web Page

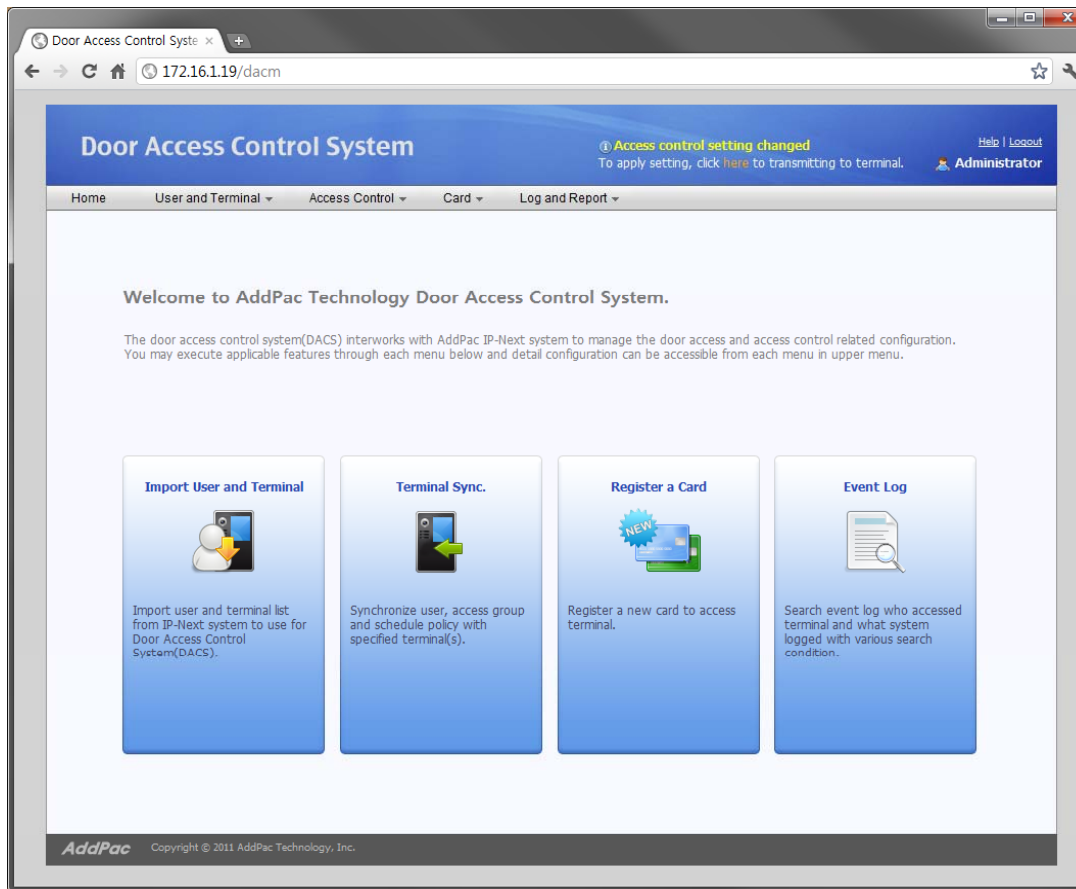

DACM (Door Access Control Manager)

Import User and Terminal

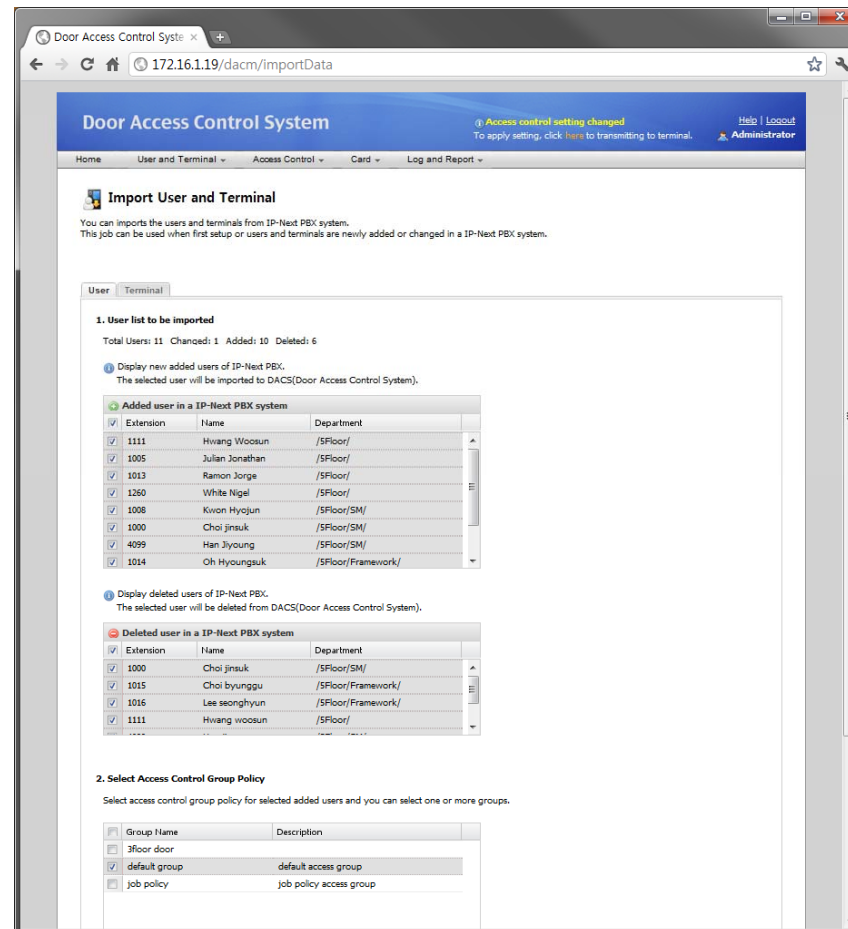

DACM (Door Access Control Manager)

User List

User List

The screenshot shows a web browser window displaying the 'Door Access Control System' user list. The page title is 'Door Access Control System' and the URL is '172.16.1.19/dacm/userList'. A notification at the top right states 'Access control setting changed' with a link to 'here' and a 'Logout' button. The user is logged in as 'Administrator'. The main content area is titled 'User List' and includes a search bar with a dropdown set to 'All Users' and an 'Import User' button. Below the search bar is a table with the following data:

	Extension	Name	Department	Access Policy	Date Created	Modify	Delete
1	1000	Choi jinsuk	/SFloor/SM/	Access Allow	2011-07-22 15:50:01		
2	1008	Kwon hyojun	/SFloor/SM/	Access Allow	2011-07-22 15:50:00		
3	1014	Oh hyongsuk	/SFloor/Framework/	Access Allow	2011-07-22 15:50:01		
4	1015	Choi byunggu	/SFloor/Framework/	Access Allow	2011-07-22 15:50:01		
5	1016	Lee seonghyun	/SFloor/Framework/	Access Allow	2011-07-22 15:50:01		

At the bottom of the page, there is a pagination control showing 'Page 1 of 1' and a 'Total: 5' indicator. The footer contains the 'AddPac' logo and 'Copyright © 2011 AddPac Technology, Inc.'.

DACM (Door Access Control Manager)

Access Control Group Management

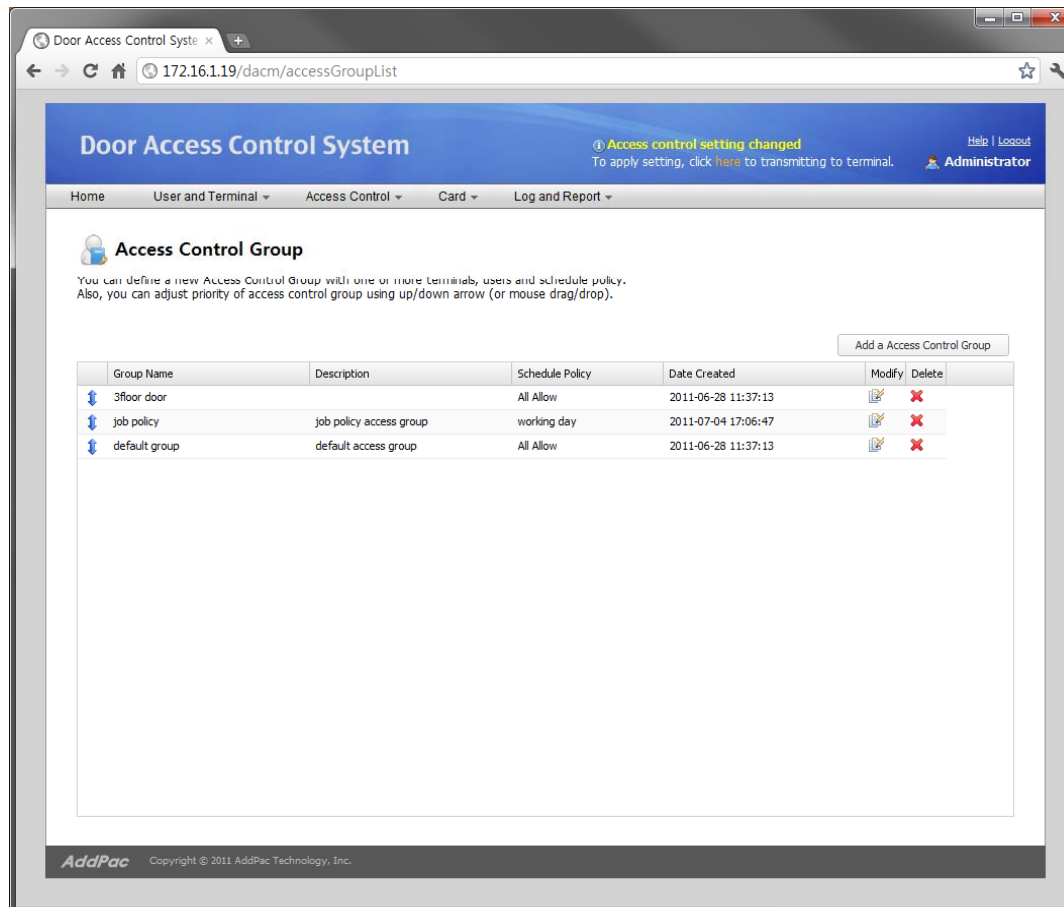

DACM (Door Access Control Manager)

Configuration Download to Terminal

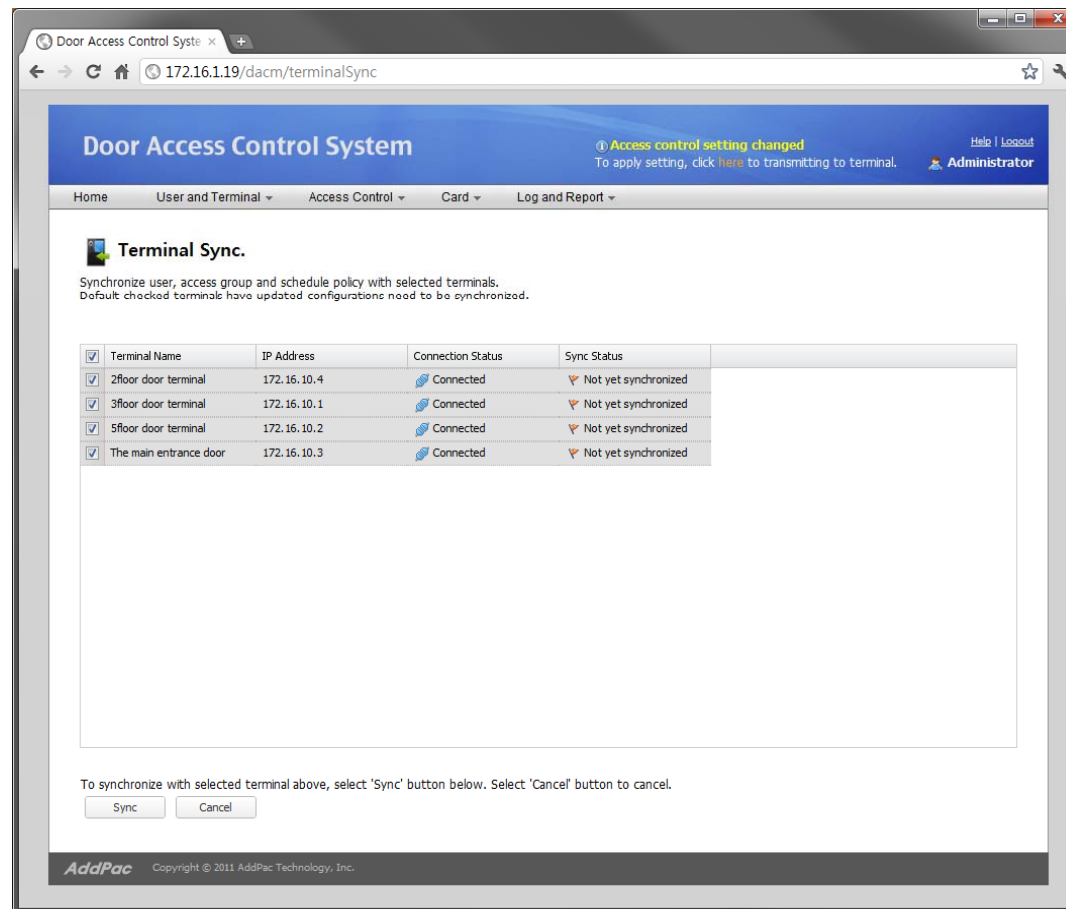

DACM (Door Access Control Manager)

RF Card Management

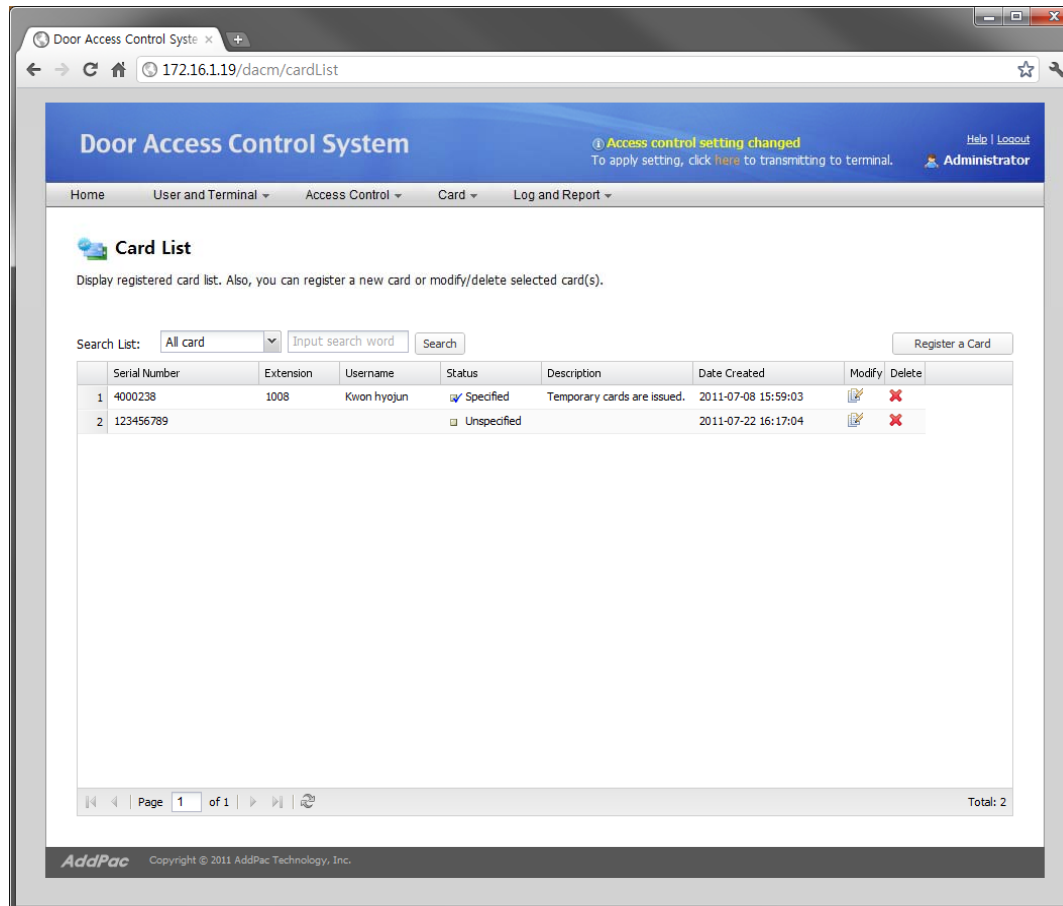

DACM (Door Access Control Manager)

Fingerprint Management

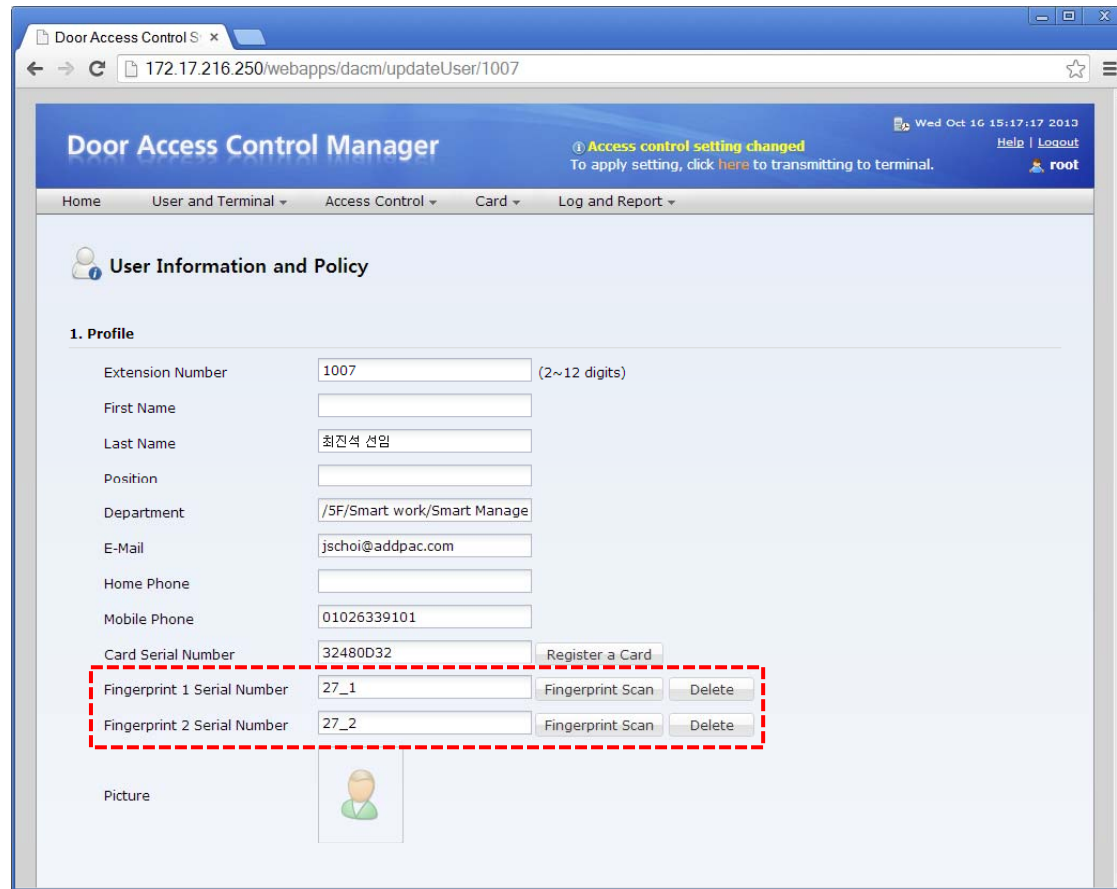

DACM (Door Access Control Manager)

Access Log Management

The screenshot shows a web browser window displaying the 'Door Access Control System' interface. The page title is 'Door Access Control System' and the URL is '172.16.1.19/dacm/eventLog'. The user is logged in as 'Administrator'. A notification banner at the top right states 'Access control setting changed' with a link to 'Apply setting, click here to transmitting to terminal.' The main content area is titled 'Event Log' and includes a search filter section with fields for 'Duration' (11-07-10 to 11-08-09), 'User Extension Number', and 'Event Level' (set to 'Error'). Below the search filters is a table of event logs.

	Time	Level	User Extension	Event
1	2011-07-15 10:27:27	Warning	1000	authentication failure
2	2011-07-15 11:25:27	Notice	1000	registration success
3	2011-07-15 12:21:27	Notice	1200	registration success
4	2011-07-16 09:27:27	Information	1201	door opened
5	2011-07-16 11:27:27	Information	1007	registration success
6	2011-07-16 17:12:00	Notice		security profile downloading completed
7	2011-07-17 18:00:00	Notice		system started

At the bottom of the page, there is a pagination control showing 'Page 1 of 1' and a 'Total: 7' indicator. The footer contains the 'AddPac' logo and 'Copyright © 2011 AddPac Technology, Inc.'



Time Attendance Web Manager Software (TAAM)

TAAM (Time and Attendance Manager)

Daily Attendance Rules

shows In (office-in time), Out (office-out time) and Regular working time, for example 9 hours

Name	Description	In	Out	Regular Hour	Date Created
1 default rule	default daily rule	09:00	18:00	9 hr	
2 Factory First Rule	Factory first daily work rule	08:00	20:00	12 hr	2011-11-07 14:32:2
3 Factory Second Rule	Factory second daily work r...	20:00	08:00	9 hr	2011-11-07 14:33:1

This day rule can be used in the monthly rule for sunday through saturday each.

TAAM (Time and Attendance Manager)

Monthly Attendance Rules

Door Access Control System

Home User and Terminal Access Control Card Time and Attendance Log and Report

Monthly Attendance Rule

1. Monthly Rule

Defines day off or work day from starting first week to sixth week of the month. Each day of the week can be applied to daily-based attendance rule.

Rule Name*

Description

1st week: Sun Mon Tue Wed Thu Fri Sat

2nd week: Sun Mon Tue Wed Thu Fri Sat

3rd week: Sun Mon Tue Wed Thu Fri Sat

4th week: Sun Mon Tue Wed Thu Fri Sat

5th week: Sun Mon Tue Wed Thu Fri Sat

6th week: Sun Mon Tue Wed Thu Fri Sat

*Clicked: Full Day Off *Non-Clicked: Work Day

Sunday: N/A

Monday: N/A

Tuesday: N/A

Wednesday: N/A

Thursday: N/A

Friday: N/A

Saturday: N/A

2. Holiday Rule

Defines rule for non-working day such as national holiday, user defined holiday in the day template.

Day Template List	
Name	Description
public holiday	public holiday description
company holiday	company holiday description

List of applied Day Templates	
Name	Description

Day of week rule from 1st week to 6th week and grey color means full day off, other color is work day

You can specify daily rule from the list for sunday through saturday

AddPac Copyright © AddPac 1999-2011 All Rights Reserved

TAAM (Time and Attendance Manager)

Business Trip and Vacation

The screenshot shows the 'Business Trip and Vacation' section of the TAAM application. It features a table with two rows of data. A dashed yellow box highlights the 'User', 'Type', 'Start', and 'End' columns for both rows. Three yellow callout boxes provide additional information: one points to the 'User' column, another to the 'Type' column, and a third to the 'Start' and 'End' columns.

Name	Description	User	Type	Start	End	Date Created	Modify	Delete
1 Rusia Business...	Presentation for Ne...	Total 2 includin...	Business trip	2011-09...	2011-10...			
2 Summer Vacati...			Vacation	2011-08...	2011-08...	2011-10-12 07:...		

one or more user can be specified for each business trip and vacation rule.

Extension user will be not processed as absentee between start day and end day, also log as user-defined time attendance code

user-defined time and attendance code for attendance report or log correction

TAAM (Time and Attendance Manager)

Time and Attendance Codes

Door Access Control System x
172.16.1.19/dacm/timeAttendanceCodeList

Time and Attendance Manager
Mon Nov 7 14:44:06 2011
Help | Logout
root

Home Policy Trip and Vacation Report Configuration Report View

Time and Attendance Codes
Shows list of user defined attendance code which can be used as correction in the attendance report.

Add a Code

Name	Description	Date Created	Modify	Delete
1 Unknown				
2 Not yet defined				
3 Late In				
4 Early Out				
5 Absence				
6 Late In/Early Out				
7 Normal				
8 Vacation				
9 Business trip				
10 Sick Leave	Sick Leave code by admin	2011-11-07 14:44:15		

system built-in time and attendance code is provided as default, for example late-in, early-out and absence

show built-in and user-defined time and attendance code which will be used in the attendance report and log correction

only user-define code can be removed if needed

AddPac Copyright © AddPac 1999-2011 All Rights Reserved Version 1.1.14

TAAM (Time and Attendance Manager)

Delivery Policy for Attendance Report

1. Report Policy
Defines email delivery policy for manager or each user to receive daily, monthly attendance report.

Send reports to the particular person every day at 08:00

Send reports to the particular person at specific day (28) of every month.

User List
Search Field: Last Name

Name	Department	Extension
batista Eike	/2F/	1000
Stefan Persson	/2F/	1016

Applied user list

Name	Department	Extension
batista Eike	/2F/	1000
Stefan Persson	/2F/	1016

Send personal monthly report to each user.

2. SMTP Server
You can specify sending email server(SMTP) configurations.

SMTP Server: 61.33.161.2

Sender Email Address: dacs_admin@company.com

Server Authentication Required

User ID: admin

Password: ****

To apply this features, select 'Apply' or 'Cancel'

Apply Cancel

AddPac Copyright © AddPac 1999-2011 All Rights Reserved Version 1.1.14

manager level users (extension) list who want to receive daily and monthly attendance report

if checked, system will send personal attendance report of each month to extension user

TAAM (Time and Attendance Manager)

Attendance Report by Date

Time and Attendance Manager
Mon Nov 7 14:52:05 2011
Help | Logout
root

Home Policy Trip and Vacation Report Configuration Report View

Attendance Report by Date
Shows attendance log for each user and summary information with specified day.

Select Date : 2011-10-19
Select Department : All

Attendance Report by Date (2011-10-19)

attendance summary for each time and attendance code with specified date

Type	Count
Late In	1
Early Out	1
Normal	10

administrator may adjust or correct attendance log which system have processed if necessary

Username	Department	In	Out	Overtime	Office Hc	Result	Correction Ti	Correct
1 Eike batista	smart management팀	08:05:00	18:05:00	0 hr	10:0...	Normal		
2 Bill Gates	multimedia팀	09:15:00	17:15:00	0 hr	08:0...	Normal	2011-11-...	
3 Larry Ellison	multimedia팀	09:00:00	18:00:00	0 hr	09:0...	Normal		
4 karl Albrecht	smart framework팀	09:00:00	17:00:00	0 hr	08:0...	Early Out		
5 Carlos Slim Helu	smart management팀	09:10:00	19:10:00	0 hr	10:0...	Normal		
6 Lakshmi Mittal	multimedia팀	09:00:00	18:00:00	4 hr	09:0...	Normal		
7 Christy Walton	smart framework팀	09:00:00	18:00:00	0 hr	09:0...	Normal		

TAAM (Time and Attendance Manager)

Attendance Report Excel Export

Attendance Report by Date (2011-10-19)							
Username	Department	In	Out	Overtime	Office Hours	Result	Correction Time
Eike batista	smart management	08:05:00	18:05:00	0 hr	10:00:00	Normal	
Bill Gates	multimedia	09:15:00	17:15:00	0 hr	08:00:00	Normal	2011-11-07 14:52:28
Larry Ellison	multimedia	09:00:00	18:00:00	0 hr	09:00:00	Normal	
karl Albrecht	smart framework	09:00:00	17:00:00	0 hr	08:00:00	Early Out	
Carlos Slim Helu	smart management	09:10:00	19:10:00	0 hr	10:00:00	Normal	
Lakshmi Mittal	multimedia	09:00:00	18:00:00	4 hr	09:00:00	Normal	
Christy Walton	smart framework	09:00:00	18:00:00	0 hr	09:00:00	Normal	
Lika Shing	smart framework	09:20:00	18:20:00	0 hr	09:00:00	Late In	
Stefan Persson	smart framework	09:00:00	20:00:00	2 hr	11:00:00	Normal	
Warren Buffett	multimedia	09:15:00	18:15:00	0 hr	09:00:00	Normal	
Amancio Ortega	smart management	09:00:00	21:00:00	3 hr	12:00:00	Normal	
Mukesh Ambani	smart management	09:00:00	18:30:00	0 hr	09:30:00	Normal	

TAAM (Time and Attendance Manager)

Attendance Report by Month



attendance summary for each time and attendance code with specified month

attendance summary for each extension user

TAAM (Time and Attendance Manager)

Attendance Daily Report by Month

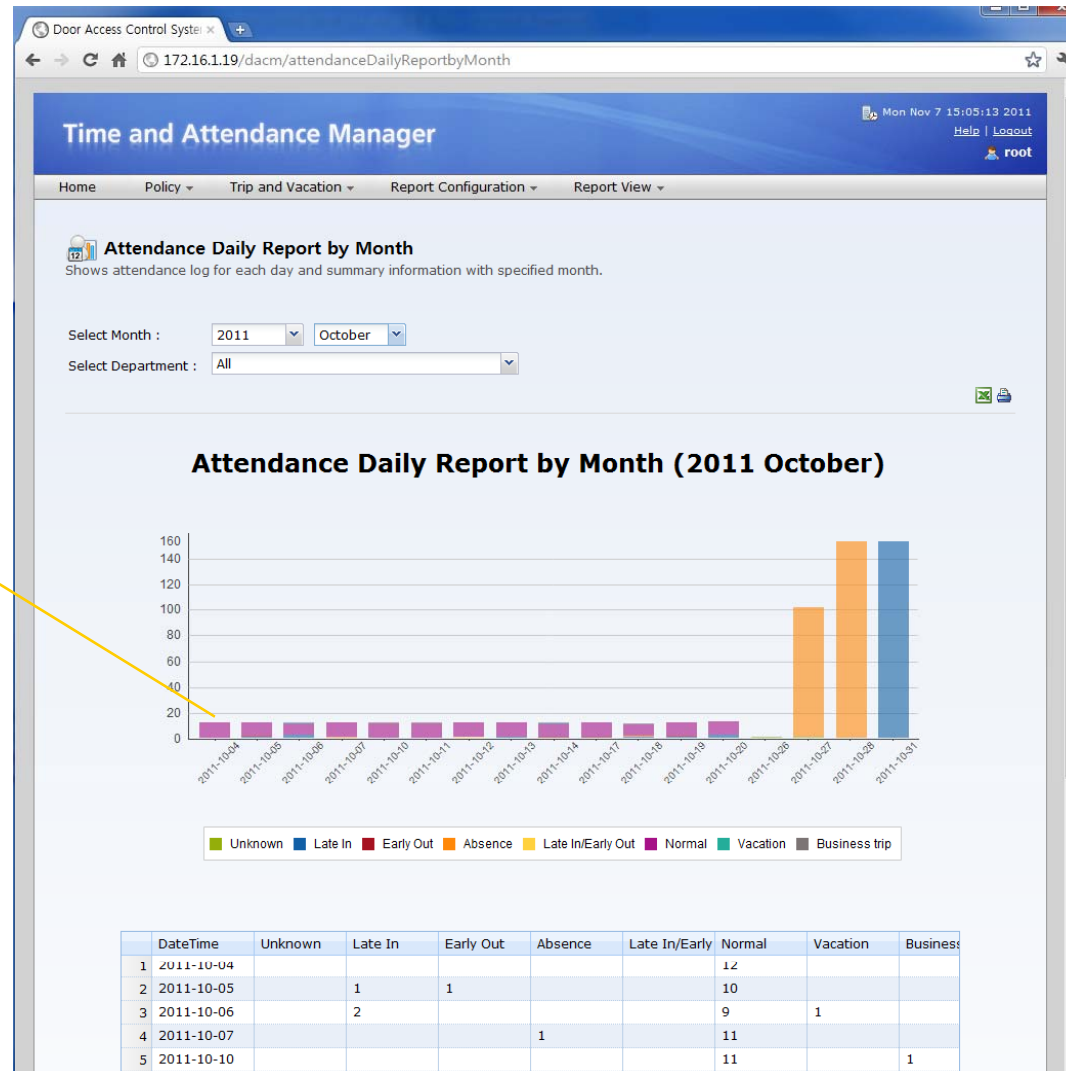

clustered column of attendance summary with time span from first to end of the month

TAAM (Time and Attendance Manager)

Attendance Personal Report

Attendance Personal Report
Shows attendance log of each day for the month with specified user.

Select Month : 2011 October
Select User : Carlos slim Helu

Attendance Personal Report (2011 October)
Carlos slim Helu (/2F/)

Type

Type	Count
Late In	1
Early Out	2
Absence	1
Normal	10
Business trip	1

	DateTime	In	Out	Overtime	Office Hours	Result
1	2011-10-04	09:00:00	18:00:00	0 hr	10:00:00	Normal
2	2011-10-05	09:00:00	18:00:00	0 hr	10:00:00	Normal
3	2011-10-06	09:00:00	18:00:00	0 hr	10:00:00	Normal
4	2011-10-07	09:00:00	18:00:00	0 hr	10:00:00	Normal
5	2011-10-10	09:10:00	19:10:00	0 hr	10:00:00	Normal
6	2011-10-11	09:10:00	19:10:00	0 hr	10:00:00	Normal
7	2011-10-12	09:10:00	19:10:00	0 hr	10:00:00	Normal
8	2011-10-13	09:10:00	19:10:00	0 hr	10:00:00	Normal
9	2011-10-14	09:10:00	17:10:00	0 hr	08:00:00	Early Out

You can specify one extension user for attendance report of the month

attendance summary for time and attendance code of a extension user



Open API

Open API

Open API for 3'rd Party Management System

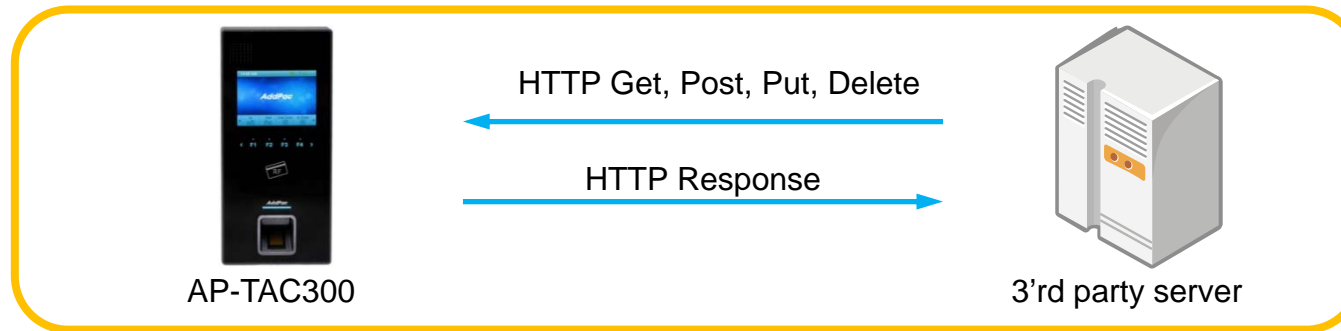

- HTTP based RESTful Open API for Door Access Management
- XML based Flexible and Expandable Message Contents
- Provides More than 40 APIs as Bellow
 - user_list(GET), user(GET, POST, PUT, DELETE), ...
 - terminal_list(GET), terminal(GET, POST, PUT, DELETE), ...
 - access_group(GET, POST, PUT, DELETE), priority (PUT), ...
 - card_list(GET), card(POST, PUT, DELETE), ...
 - schedule_template(GET, POST, PUT, DELETE), rule(GET, POST, PUT, DELETE) ,...

Application Network Diagram

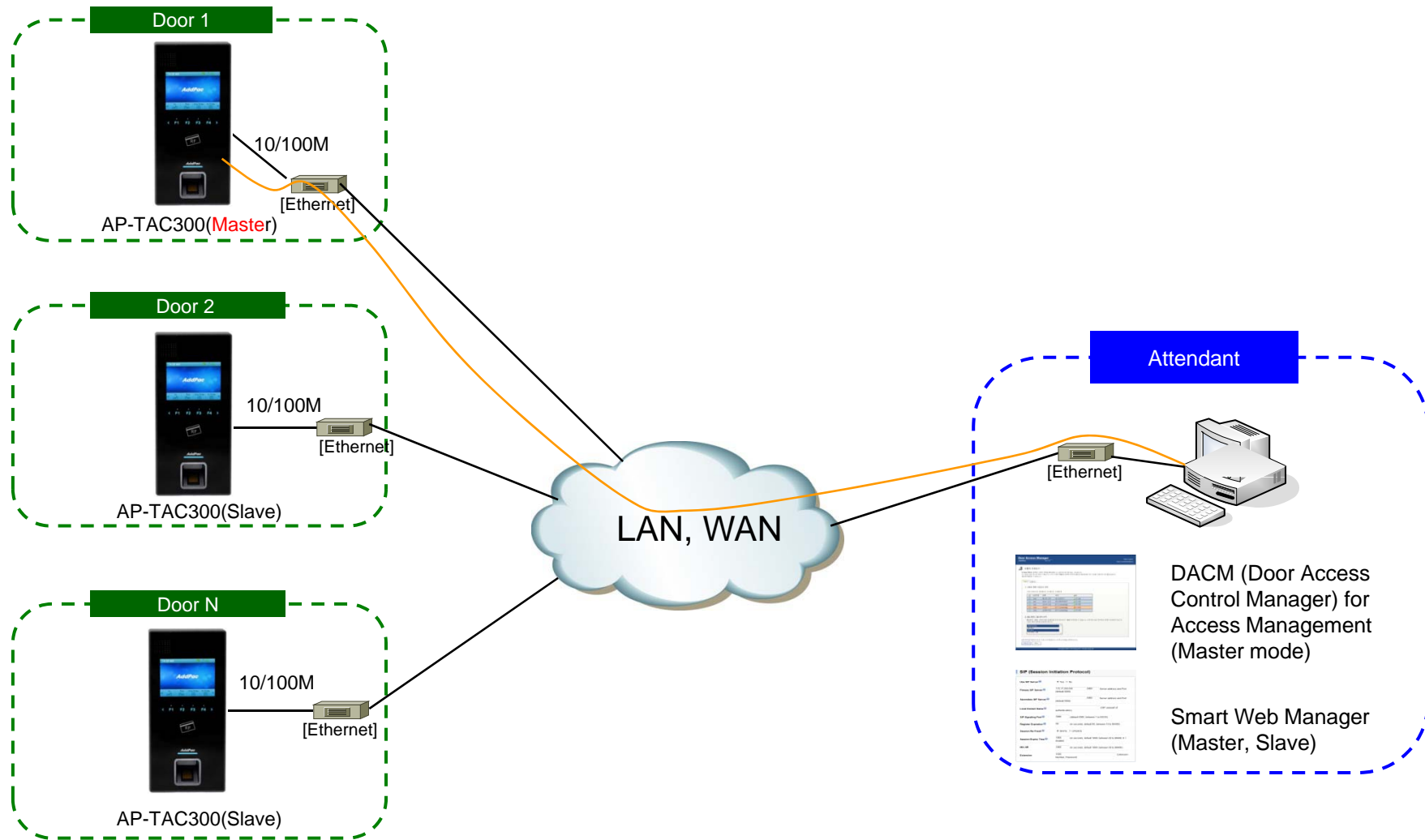

Ordering Information

- **AP-TAC300 Time & Attendance Door Access Controller Hardware**
 - AP-TAC300 Main Body
 - RISC Microprocessor with High-end Programmable DSP Architecture
 - 3.5 Inch LCD
 - Fingerprint Recognition, RF card Interface
 - STILL Chassis
 - Internal Speaker
 - 1-ports 10/100Mbps Fast Ethernet
 - PoE Interface
 - Including Network Cable Set & Ext. Power Supply, etc.
- **Built-in APOS Internetworking Software for AP-TAC300**
- **Including 1 Year Hardware Warranty**
- **Product Documents**
 - Install and Operation Guide (PDF)
- **Pricing**
 - AddPac Technology Regional Sales Manager
 - Authorized Sales and Marketing Representatives



Thank you!

AddPac Technology Co., Ltd.
Sales and Marketing

Phone +82.2.568.3848 (KOREA)

FAX +82.2.568.3847 (KOREA)

E-mail sales@addpac.com