

# AP-ACS10000 Large Scale Door Access Control Server



AP-VP280



IPNext180 Hybrid IP-PBX



AP-ACS10000  
(Door Access Control Server)



AP-VAC20



AP-VAC50

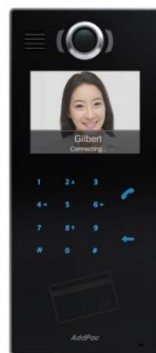

AP-VAC100



AP-VAC200

**AddPac**

**AddPac Technology**

2014, Sales and Marketing

[www.addpac.com](http://www.addpac.com)

# Contents

- DACS(Door Access Control System) Network Diagram
- System Redundancy Diagram for Fault Tolerant Service
- AP-ACS10000 DACS Main Features
- AP-ACS10000 DACS Hardware Specification
- DACS System Message Flow (Examples)
- SIP VoIP Message Flow (Example)
- DACS Software
  - Door Access Control Manager
  - Time and Attendance Manager
- Open API for Third Party Controller
- IP Video Door Phone Comparison Table
- Hybrid IP-PBX Comparison Table
- IP Video Phone Comparison Table

# IP-PBX Environment

## AP-ACS10000 DACS (Door Access Control System)

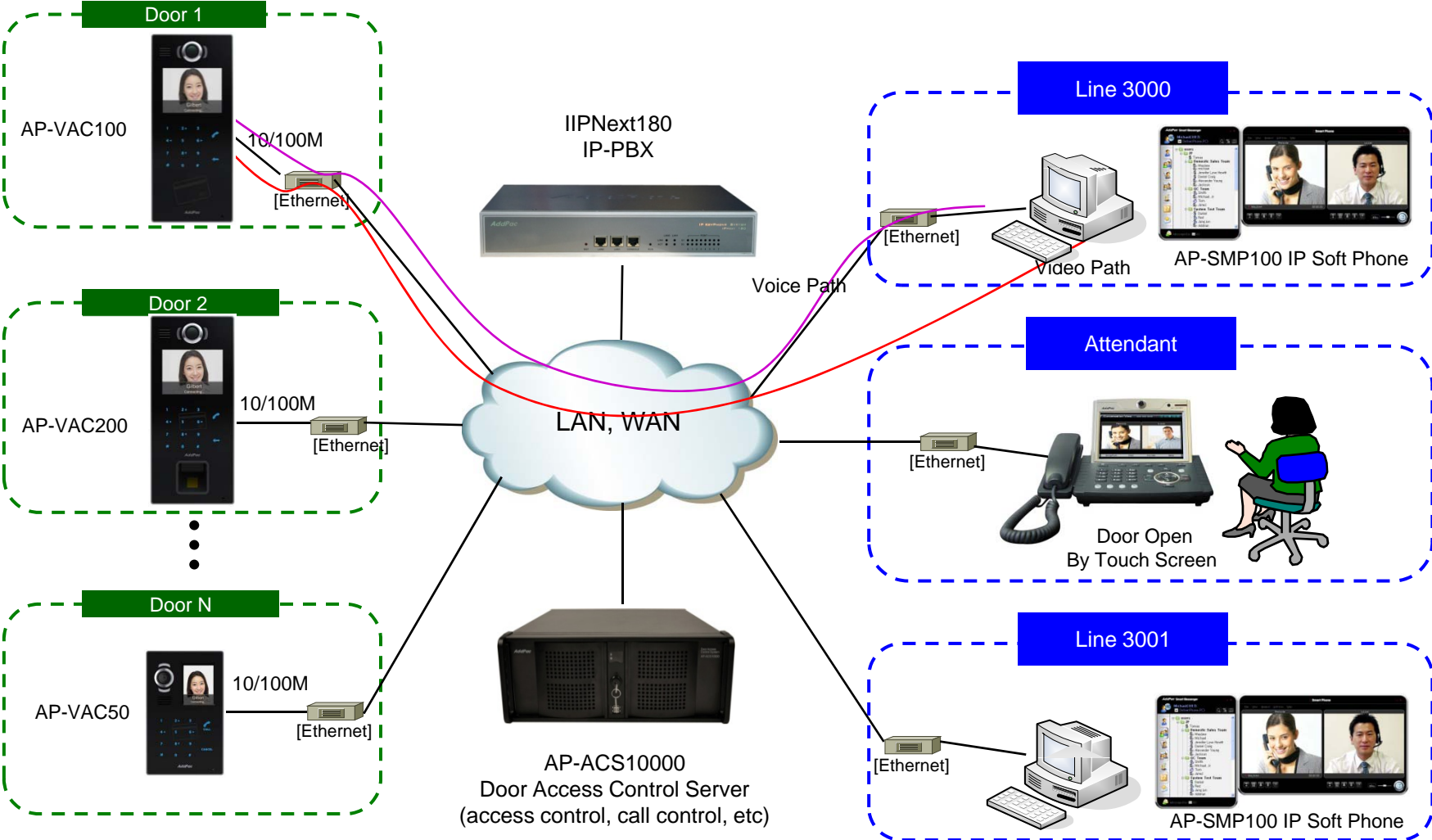

# System Redundancy for Fault Tolerant Service

## AP-ACS10000 DACS (Door Access Control System)

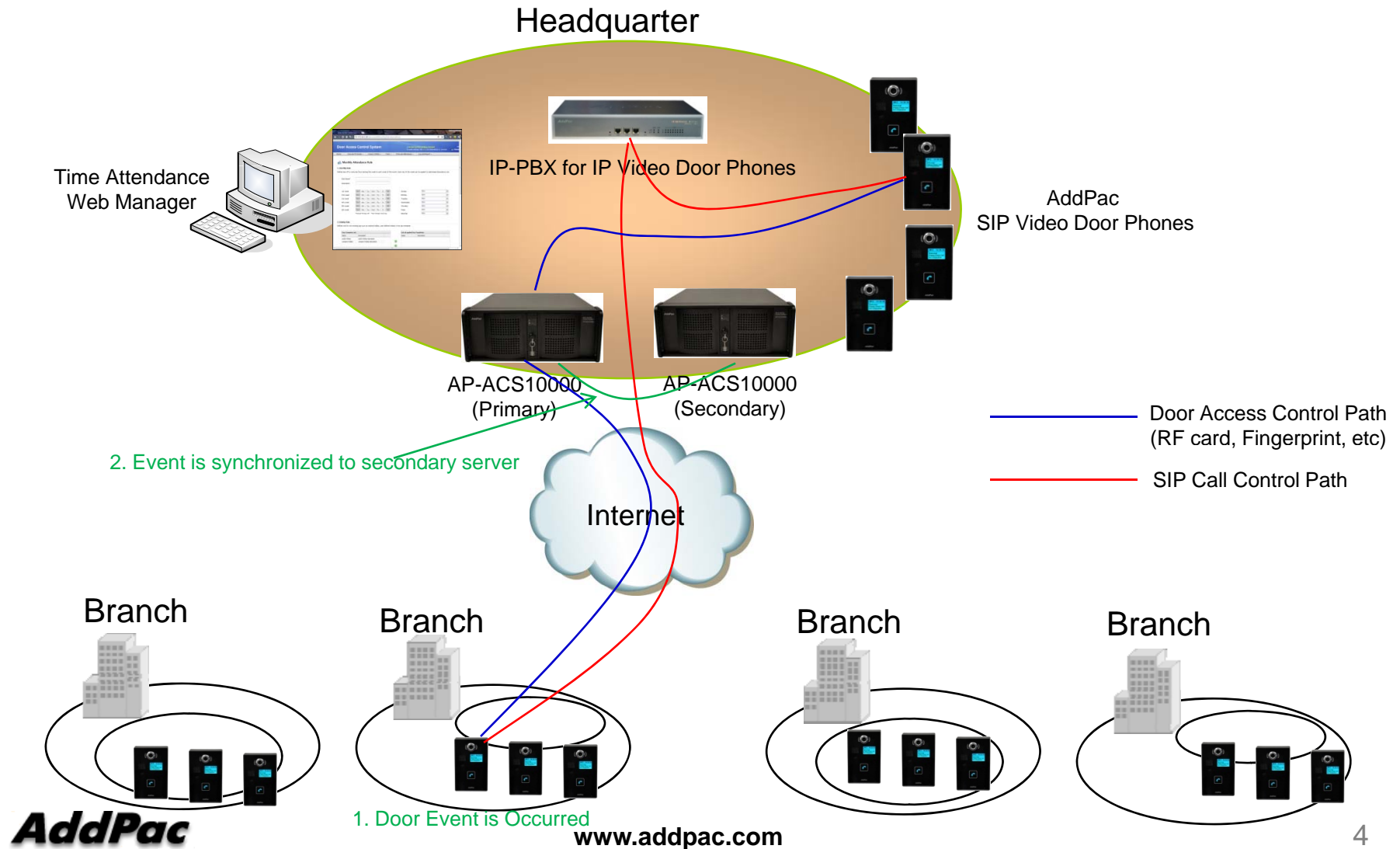

# Main Features

## AP-ACS10000 DACS (Door Access Control System)

- Large Scale Door Access Control Service Features
- Linux Operating System
- Time & Attendance Control System
- Server & Client Architecture
- System Duplication Support for Fault Tolerant Service
- RF Card, Fingerprint Video Door Phone Interworking Service
- Smart Time & Attendance Manager Support (Web based)
- Excel File Import Function for Large User Registration
- Powerful Management and User Friendly Features
- Open API Support for Third Party
- Firmware Upgradeable Architecture
- Up to 4 x 3.5Inch Hard Disk (SATA Type, 2Tera Byte Support)
- One(1) 10/100/1000Mbps Gigabit Ethernet Interface
- USB Interface Support (Front Side, Back Side)

# Hardware Specification

AP-ACS10000 DACS (Door Access Control System)



- High Performance Computing Power
- Main Chassis
  - Network Interface
    - One(1) 10/100/1000Mbps Fast Ethernet
  - Video Output Interface
    - HDMI, DVI, RGB Video Output
  - USB 2.0 Interfaces for Mouse, Keyboard, etc
  - One(1) DVD Writer for Video File Backup
  - Up to Four(4) Hard Disk

# Hardware Specification

AP-ACS10000 DACS (Door Access Control System)

High End Processor

Front Side

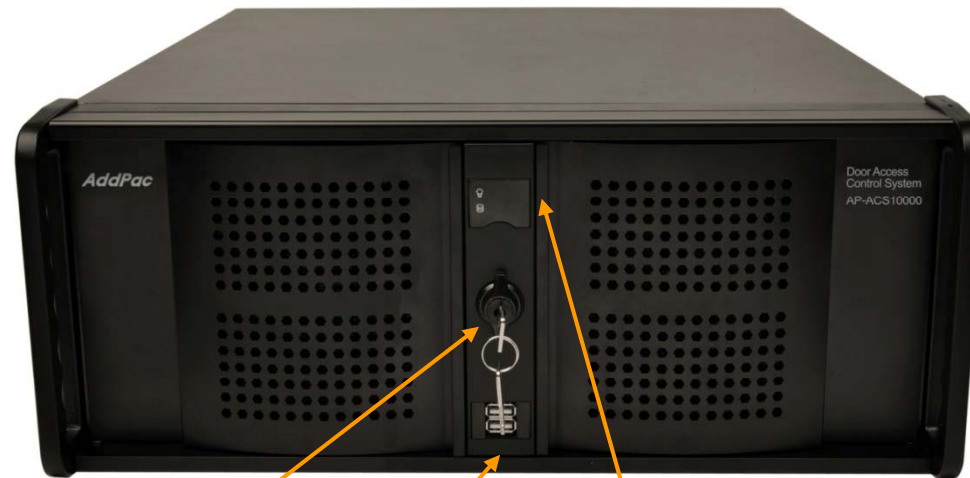

Cabinet Open Key

USB Interface

Power & HDD Access Indication LAMP

# Hardware Specification

AP-ACS10000 DACS (Door Access Control System)

High End Processor

Front Side

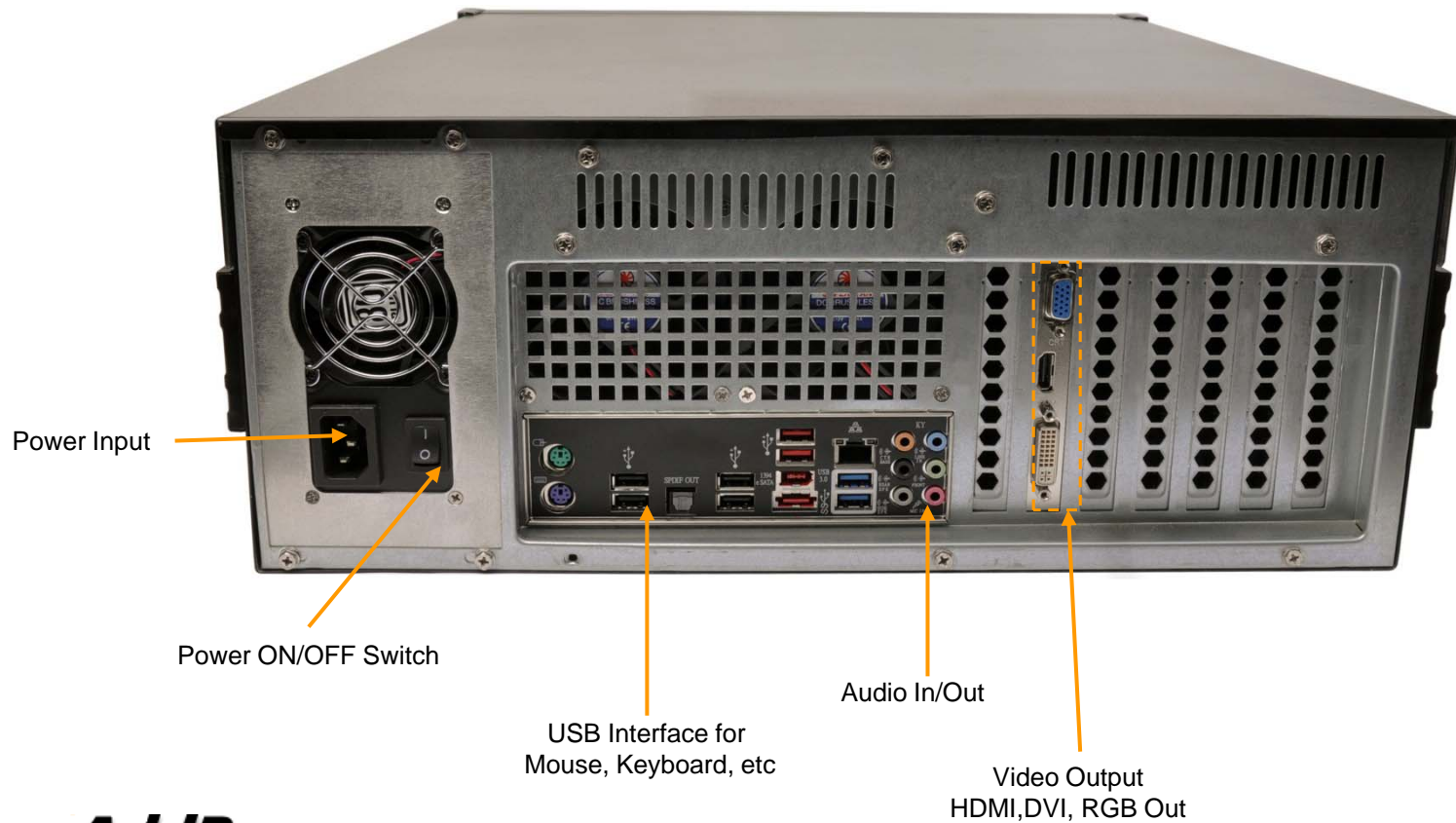





# DACS System Message Flow

# DACS System Message Flow

## Registration and KeepAlive

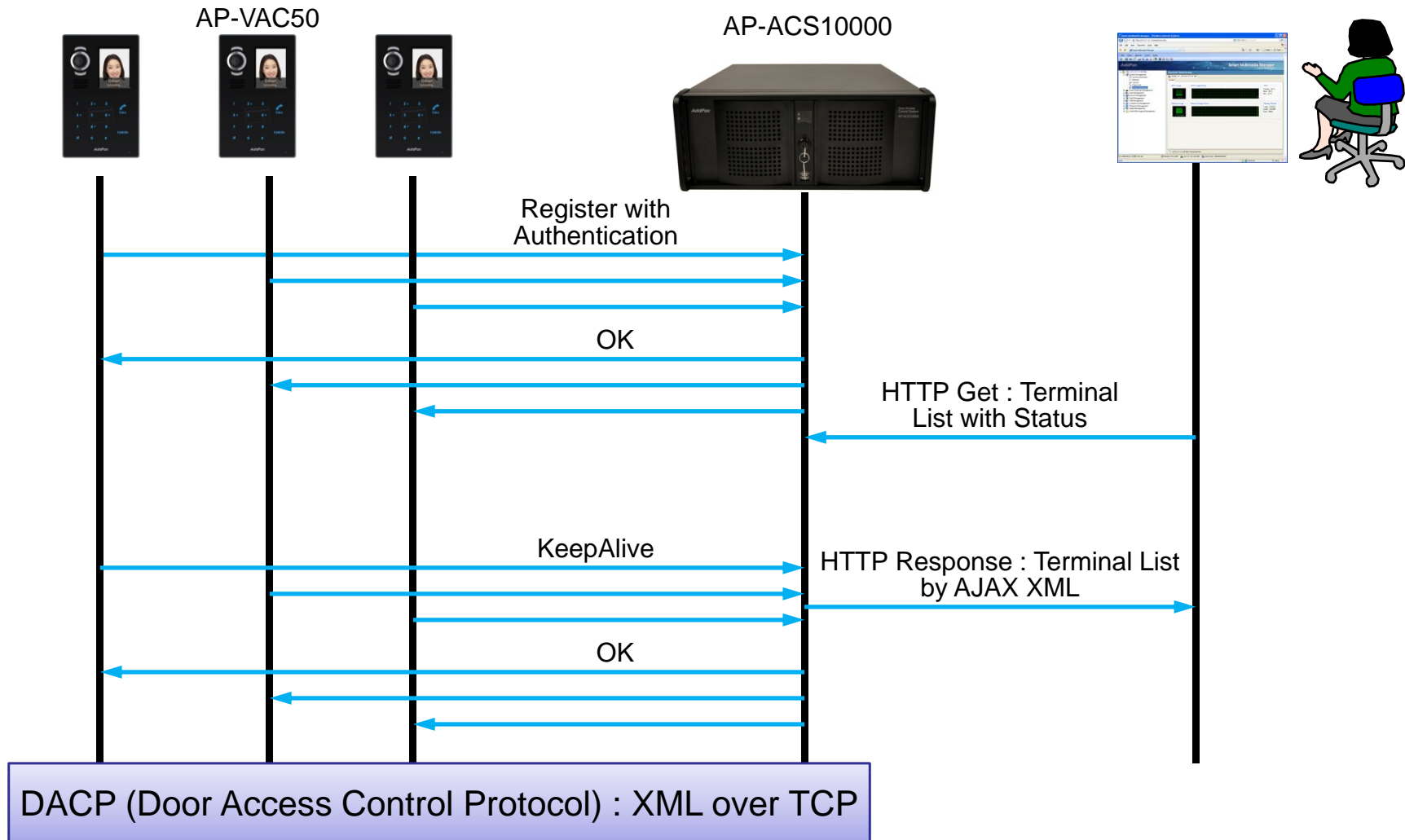

# DACS System Message Flow

## Access Privilege and Schedule Download

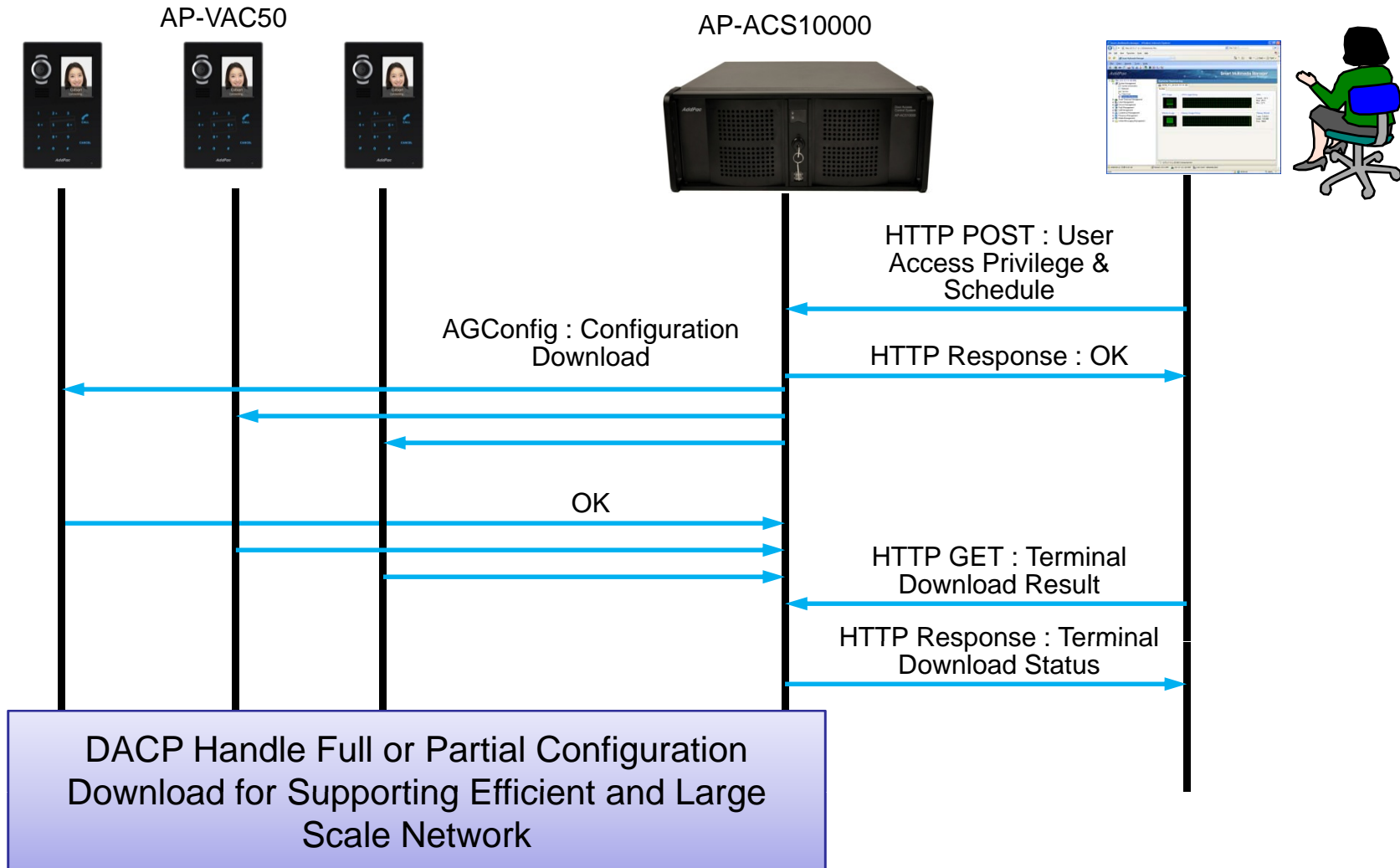

# DACS System Message Flow

## RF Card Read/Write and Registration

AP-VAC50



AP-ACS10000

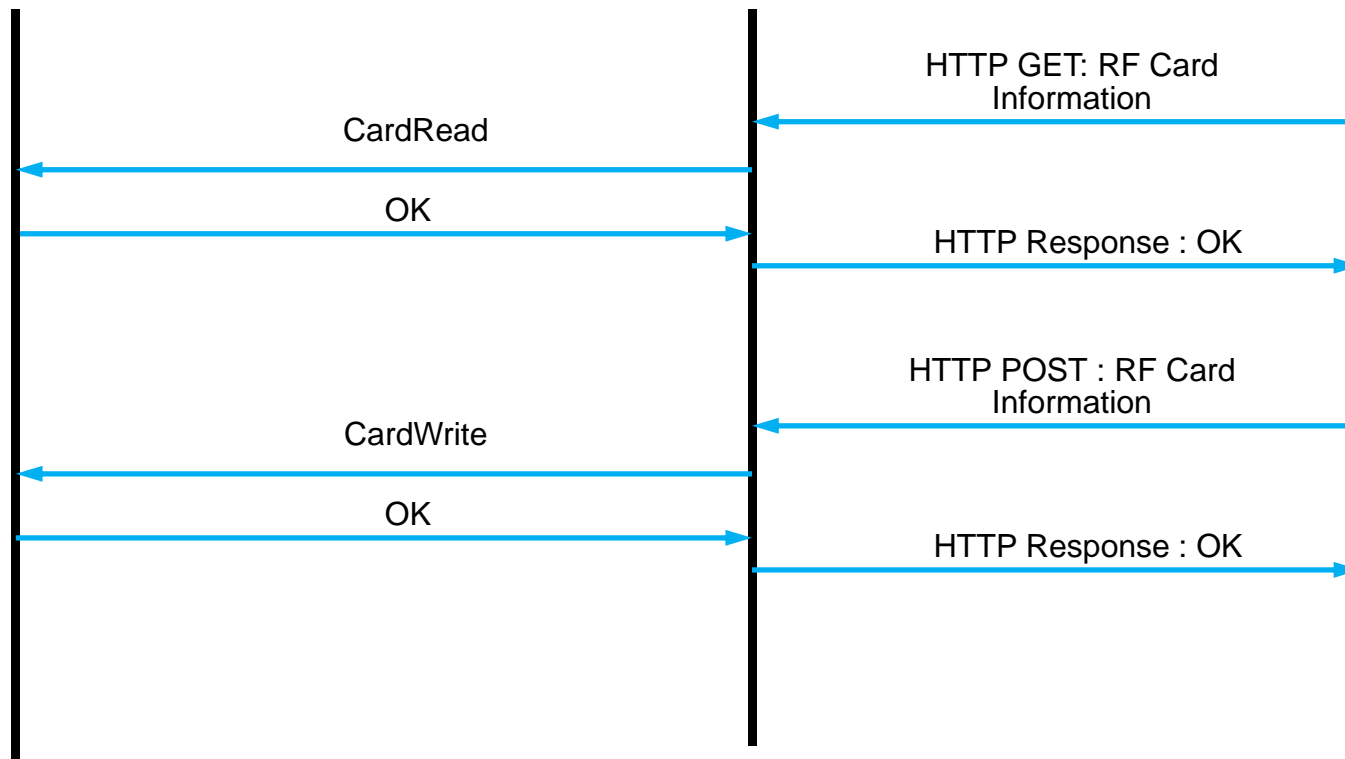
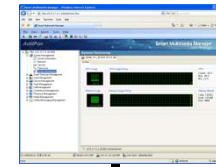

# DACS System Message Flow

## Door Open by RF Card or Password

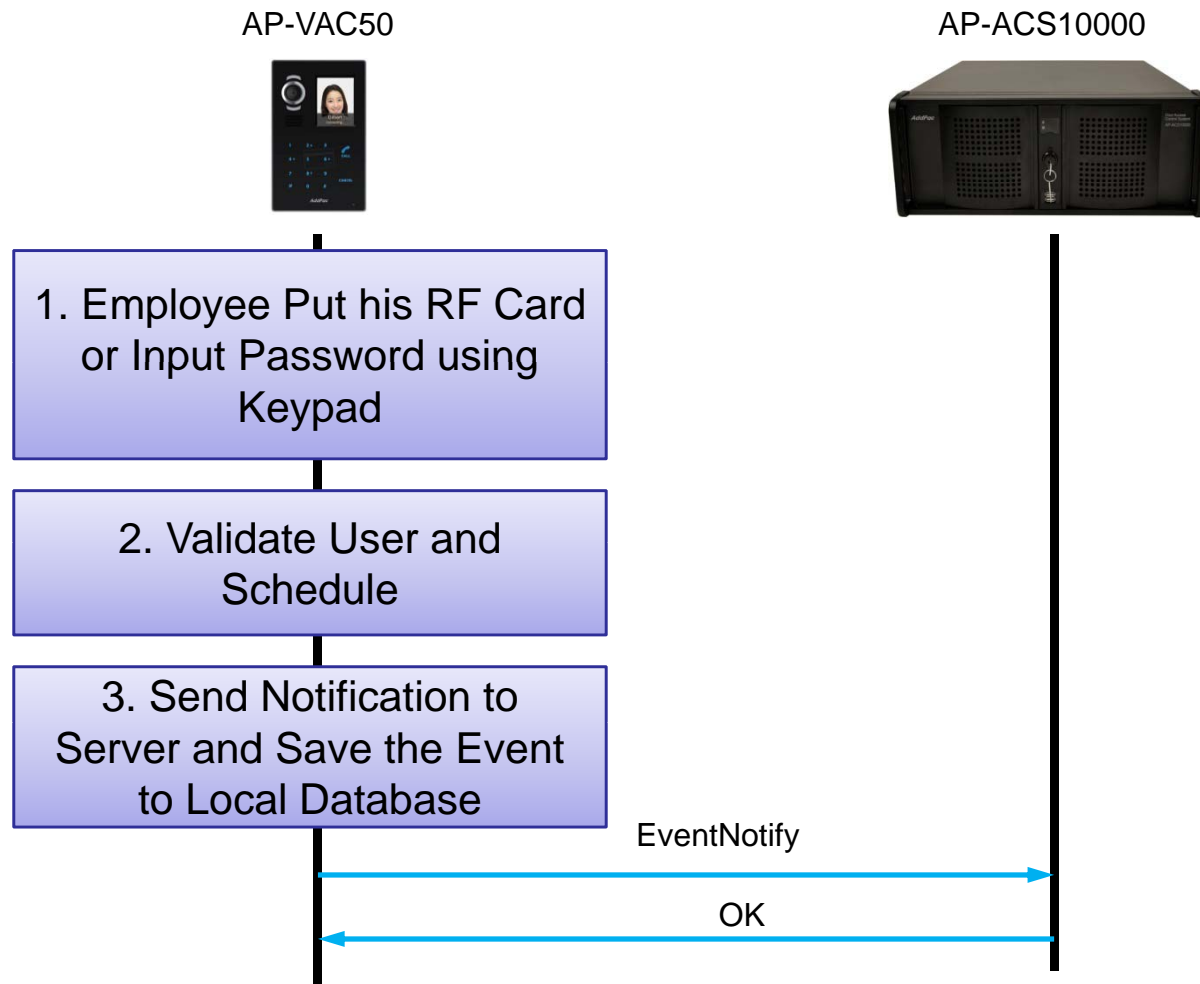

# DACS System Message Flow

## Door Open by Fingerprint

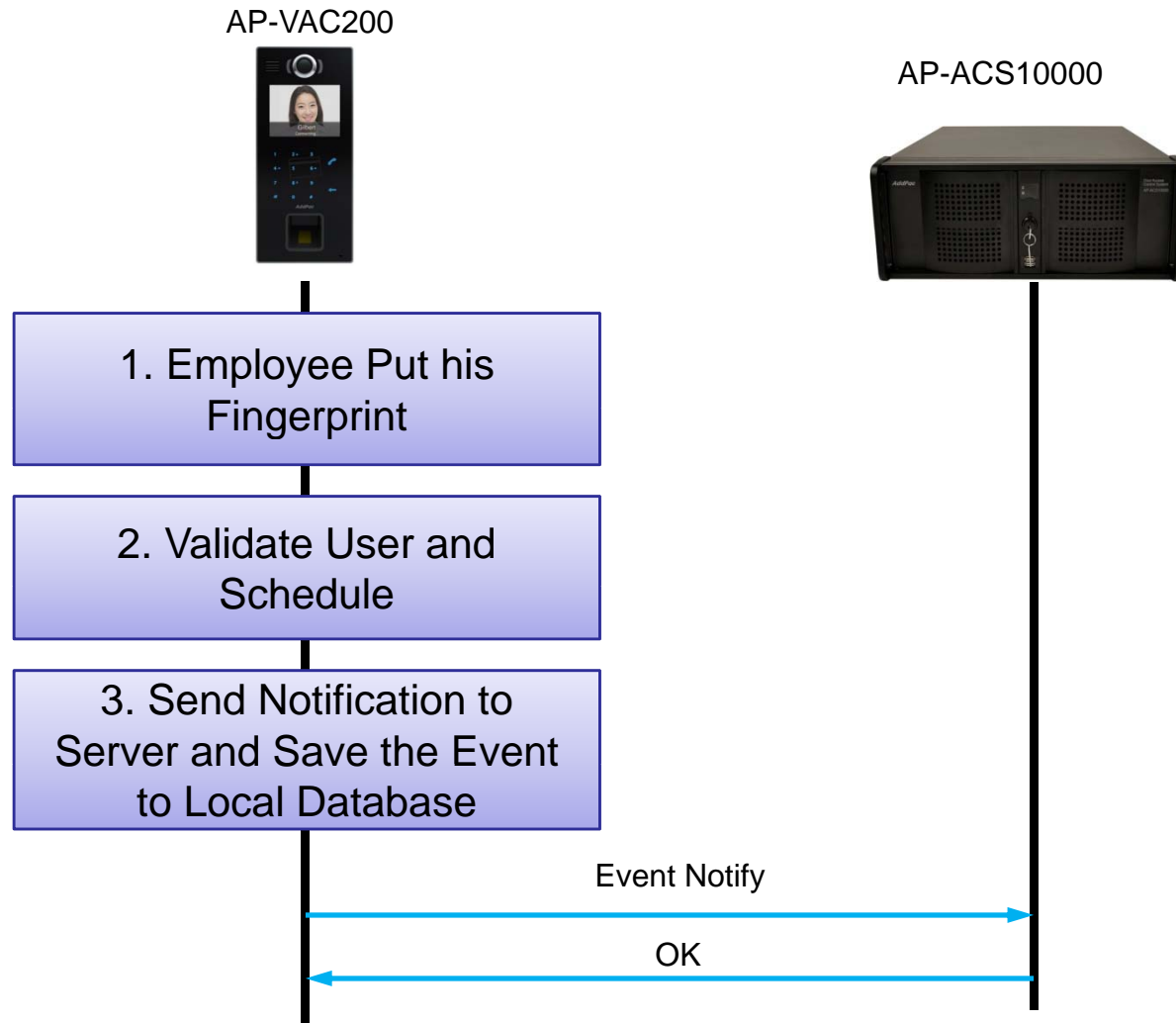

# SIP VoIP Message Flow

## Door Open by Other Terminal

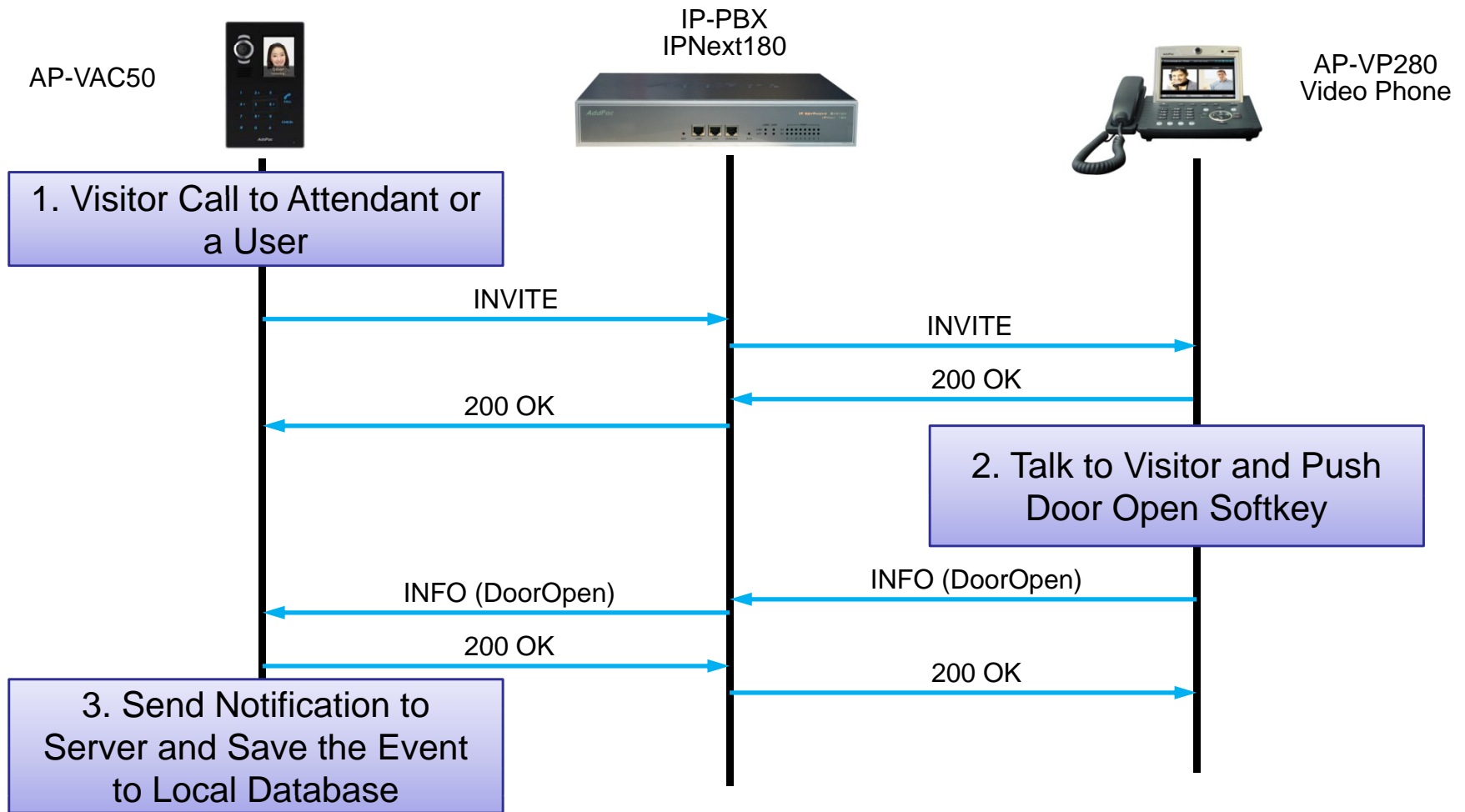



# Door Access Control System Web Manager Software (DACM, TAAM)



# DACS (Door Access Control System)

## Login page

The screenshot shows a web browser window with the URL `172.16.1.19/index.php`. The page title is "Door Access Control System". The main content area features the "AddPac Door Access Control System" logo and a login form with fields for "Administrator ID" (containing "root") and "Password" (masked with dots). Below the form are two buttons: "Door Access Control Manager" and "Time and Attendance Manager".

Annotations on the screenshot include:

- A yellow box at the top center containing the text: "You can log on 'Door Access Control Manager' or 'Time and Attendance Manager' if license is valid and administrator have authentication right". A yellow arrow points from this box to the login form.
- A blue box on the left containing the text: "Log on to Door Access Control Management". A blue arrow points from this box to the "Door Access Control Manager" button.
- A blue box on the right containing the text: "Log on to Time and Attendance Management". A blue arrow points from this box to the "Time and Attendance Manager" button.



# Door Access Control Web Manager Software (DACM)

# DACM (Door Access Control Manager)

## Main Web Page

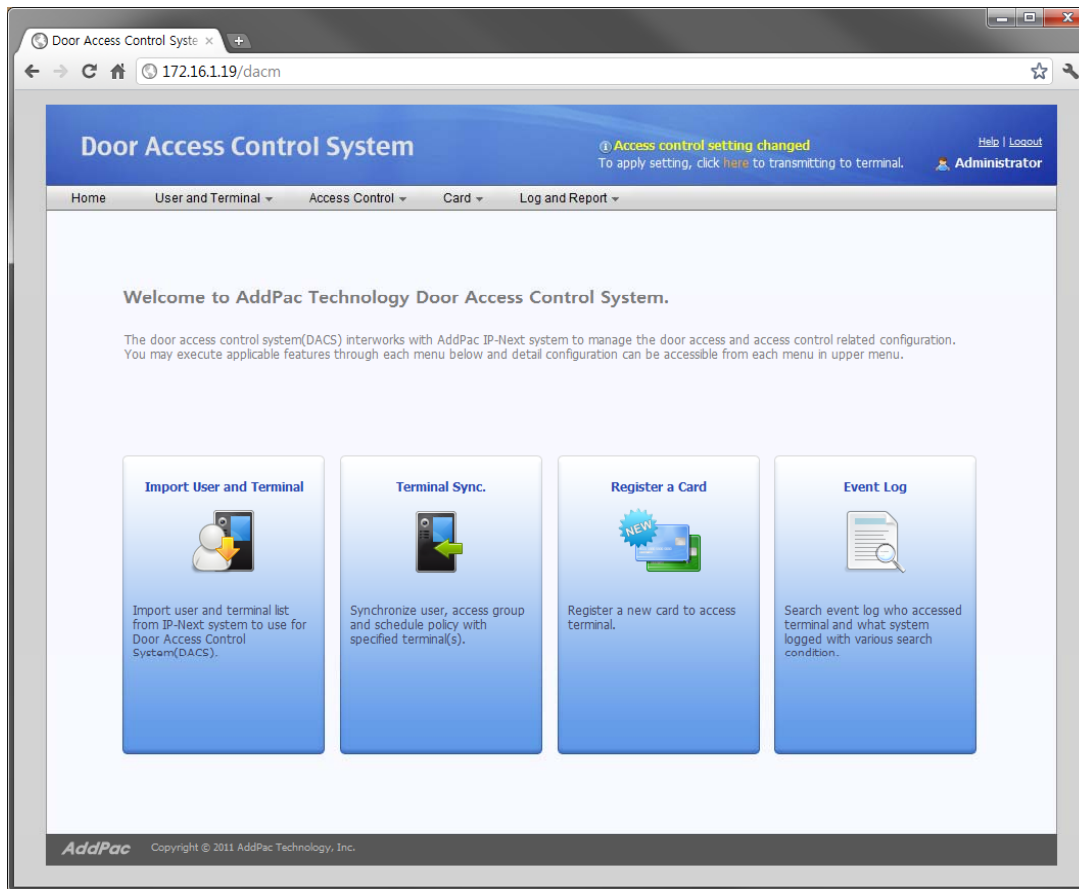

# DACM (Door Access Control Manager)

## Import User and Terminal

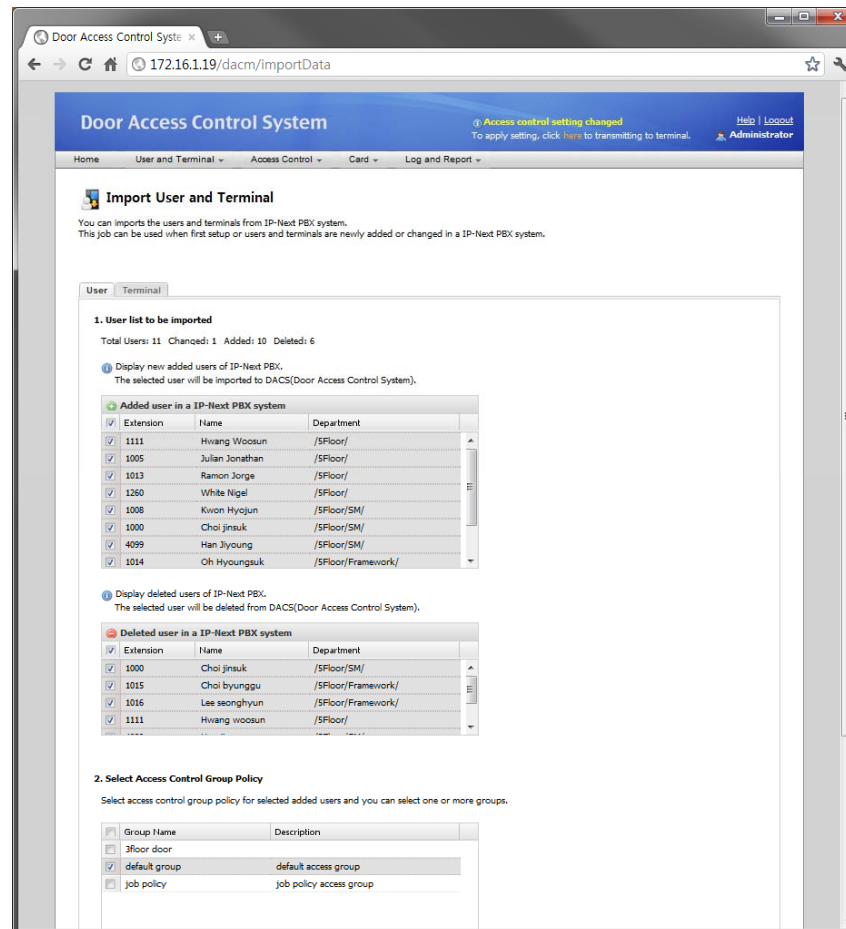

# DACM (Door Access Control Manager)

## User List

## User List

The screenshot shows a web browser window displaying the 'Door Access Control System' user list. The page title is 'Door Access Control System' and the URL is '172.16.1.19/dacm/userList'. A notification at the top right states 'Access control setting changed' with a link to 'here' and a 'Logout' button. The user is logged in as 'Administrator'. The main content area is titled 'User List' and includes a search bar with a dropdown set to 'All Users' and an 'Import User' button. Below the search bar is a table with the following data:

	Extension	Name	Department	Access Policy	Date Created	Modify	Delete
1	1000	Choi jinsuk	/SFloor/SM/	Access Allow	2011-07-22 15:50:01		
2	1008	Kwon hyojun	/SFloor/SM/	Access Allow	2011-07-22 15:50:00		
3	1014	Oh hyongsuk	/SFloor/Framework/	Access Allow	2011-07-22 15:50:01		
4	1015	Choi byunggu	/SFloor/Framework/	Access Allow	2011-07-22 15:50:01		
5	1016	Lee seonghyun	/SFloor/Framework/	Access Allow	2011-07-22 15:50:01		

At the bottom of the page, there is a pagination control showing 'Page 1 of 1' and a 'Total: 5' indicator. The footer contains the 'AddPac' logo and 'Copyright © 2011 AddPac Technology, Inc.'.

# DACM (Door Access Control Manager)

## Access Control Group Management

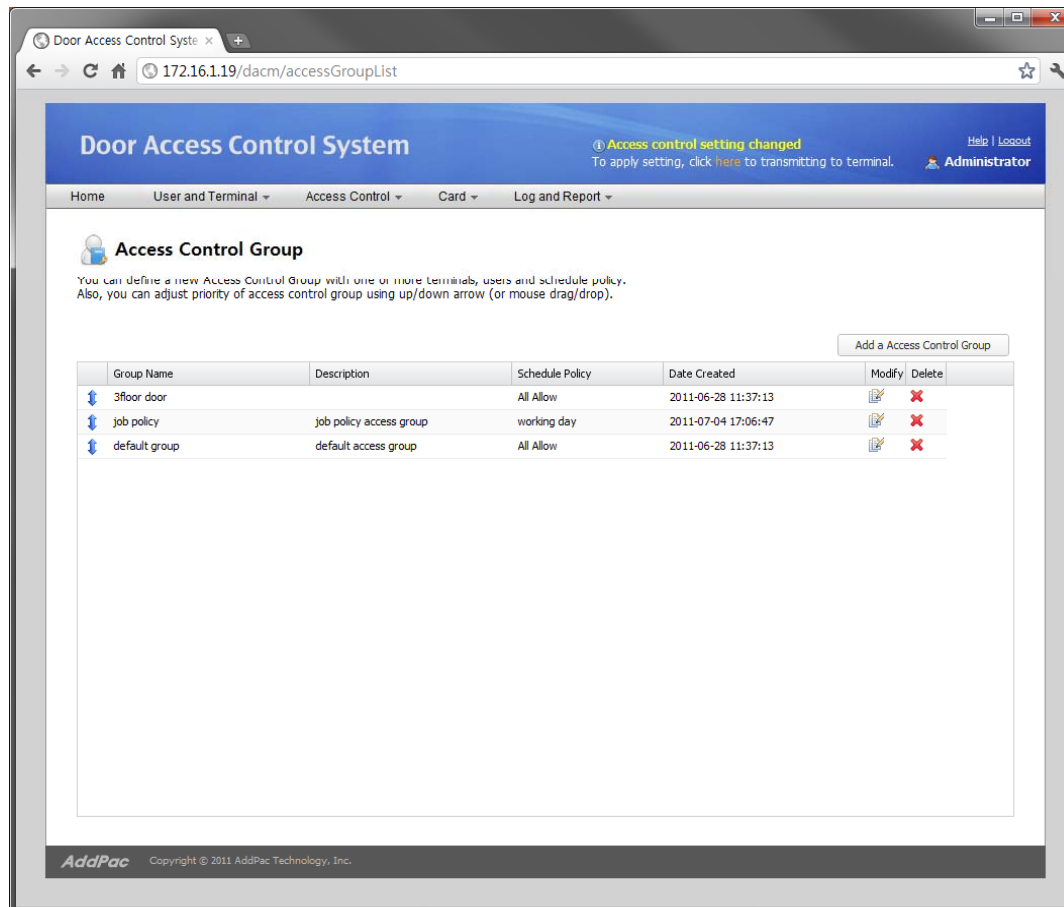

# DACM (Door Access Control Manager)

## Configuration Download to Terminal

Door Access Control System

Access control setting changed  
To apply setting, click [here](#) to transmitting to terminal.

Help | Logout  
Administrator

Home User and Terminal Access Control Card Log and Report

### Terminal Sync.

Synchronize user, access group and schedule policy with selected terminals.  
Default checked terminals have updated configurations need to be synchronized.

<input checked="" type="checkbox"/>	Terminal Name	IP Address	Connection Status	Sync Status
<input checked="" type="checkbox"/>	2floor door terminal	172.16.10.4	Connected	Not yet synchronized
<input checked="" type="checkbox"/>	3floor door terminal	172.16.10.1	Connected	Not yet synchronized
<input checked="" type="checkbox"/>	5floor door terminal	172.16.10.2	Connected	Not yet synchronized
<input checked="" type="checkbox"/>	The main entrance door	172.16.10.3	Connected	Not yet synchronized

To synchronize with selected terminal above, select 'Sync' button below. Select 'Cancel' button to cancel.

AddPac Copyright © 2011 AddPac Technology, Inc.

# DACM (Door Access Control Manager)

## RF Card Management

Door Access Control System

Access control setting changed  
To apply setting, click [here](#) to transmitting to terminal.

Help | Logout  
Administrator

Home User and Terminal Access Control Card Log and Report

### Card List

Display registered card list. Also, you can register a new card or modify/delete selected card(s).

Search List: All card

Serial Number	Extension	Username	Status	Description	Date Created	Modify	Delete
1 4000238	1008	Kwon hyojun	<input checked="" type="checkbox"/> Specified	Temporary cards are issued.	2011-07-08 15:59:03		
2 123456789			<input type="checkbox"/> Unspecified		2011-07-22 16:17:04		

Page 1 of 1 Total: 2

AddPac Copyright © 2011 AddPac Technology, Inc.



# DACM (Door Access Control Manager) Fingerprint Management

The screenshot shows a web browser window with the URL `172.17.216.250/webapps/dacm/updateUser/1007`. The page title is "Door Access Control Manager". A notification at the top right states: "Access control setting changed. To apply setting, click here to transmitting to terminal." The user is logged in as "root".

The main content area is titled "User Information and Policy" and contains a "1. Profile" section with the following fields:

- Extension Number: 1007 (2~12 digits)
- First Name: [Empty]
- Last Name: 최진석 선임
- Position: [Empty]
- Department: /5F/Smart work/Smart Manage
- E-Mail: jschoi@addpac.com
- Home Phone: [Empty]
- Mobile Phone: 01026339101
- Card Serial Number: 32480D32 (with "Register a Card" button)
- Fingerprint 1 Serial Number: 27\_1 (with "Fingerprint Scan" and "Delete" buttons)
- Fingerprint 2 Serial Number: 27\_2 (with "Fingerprint Scan" and "Delete" buttons)

The fingerprint management section is highlighted with a red dashed box. Below the fingerprint fields is a "Picture" field with a placeholder image of a person.

# DACM (Door Access Control Manager)

## Access Log Management

The screenshot shows a web browser window displaying the 'Door Access Control System' interface. The page title is 'Door Access Control System' and the URL is '172.16.1.19/dacm/eventLog'. The user is logged in as 'Administrator'. A notification banner at the top right states 'Access control setting changed' and provides a link to 'Apply setting, click here to transmitting to terminal.' The main content area is titled 'Event Log' and includes a search filter section with the following fields:

- Duration: 11-07-10 ~ 11-08-09
- User Extension Number: (empty)
- Event Level: Error

Buttons for 'Search' and 'Reset' are located below the filters. The event log table below contains the following data:

	Time	Level	User Extension	Event
1	2011-07-15 10:27:27	Warning	1000	authentication failure
2	2011-07-15 11:25:27	Notice	1000	registration success
3	2011-07-15 12:21:27	Notice	1200	registration success
4	2011-07-16 09:27:27	Information	1201	door opened
5	2011-07-16 11:27:27	Information	1007	registration success
6	2011-07-16 17:12:00	Notice		security profile downloading completed
7	2011-07-17 18:00:00	Notice		system started

The interface also features a pagination bar at the bottom showing 'Page 1 of 1' and a 'Total: 7' count.



# Time Attendance Web Manager Software (TAAM)

# TAAM (Time and Attendance Manager)

## Monthly Attendance Rules

**Door Access Control System**

172.16.1.19/dacm/monthlyWorkRuleList

### Monthly Attendance Rule List

Shows list of monthly based attendance rule for time(week, full day off, national holiday)

Name	Description
1 Default Rule	Default attendance rule
2 Head Office Rule	Head office work monthly rule
3 Factory First Rule	Factory first work monthly rule
4 Factory Second Rule	Factory second work monthly rule

**1. Monthly Rule**

Defines day off or work day from starting first week to sixth week of the month. Each day of the week can be applied to daily-based attendance rule.

Rule Name\*

Description

1st week: Sun Mon Tue Wed Thu Fri Sat

2nd week: Sun Mon Tue Wed Thu Fri Sat

3rd week: Sun Mon Tue Wed Thu Fri Sat

4th week: Sun Mon Tue Wed Thu Fri Sat

5th week: Sun Mon Tue Wed Thu Fri Sat

6th week: Sun Mon Tue Wed Thu Fri Sat

\*Clicked: Full Day Off \*Non-Clicked: Work Day

Sunday: N/A

Monday: N/A

Tuesday: N/A

Wednesday: N/A

Thursday: N/A

Friday: N/A

Saturday: N/A

**2. Holiday Rule**

Defines rule for non-working day such as national holiday, user defined holiday in the day template.

Day Template List	
Name	Description
public holiday	public holiday description
company holiday	company holiday description

List of applied Day Templates	
Name	Description

**Day of week rule from 1<sup>st</sup> week to 6<sup>th</sup> week and grey color means full day off, other color is work day**

**You can specify daily rule from the list for sunday through saturday**

AddPac Copyright © AddPac 1999-2011 All Rights Reserved

# TAAM (Time and Attendance Manager)

## Business Trip and Vacation

The screenshot shows the 'Business Trip and Vacation' section of the TAAM application. It includes a table with two entries: a business trip and a vacation. Annotations explain that multiple users can be specified for a business trip, that extension users are not processed as absentees during the trip period, and that user-defined time and attendance codes are used for reporting and corrections.

Name	Description	User	Type	Start	End	Date Created	Modify	Delete
1 Rusia Business...	Presentation for Ne...	Total 2 includin...	Business trip	2011-09...	2011-10...			
2 Summer Vacati...			Vacation	2011-08...	2011-08...	2011-10-12 07:...		

**one or more user can be specified for each business trip and vacation rule.**

**Extension user will be not processed as absentee between start day and end day, also log as user-defined time attendance code**

**user-defined time and attendance code for attendance report or log correction**

# TAAM (Time and Attendance Manager)

## Time and Attendance Codes

The screenshot shows a web browser window with the URL `172.16.1.19/dacm/timeAttendanceCodeList`. The page title is "Time and Attendance Manager" and the user is logged in as "root". The main content area is titled "Time and Attendance Codes" and includes a description: "Shows list of user defined attendance code which can be used as correction in the attendance report." There is an "Add a Code" button. A table lists the codes, with a dashed yellow box highlighting the first ten rows. Three callout boxes provide additional information:

- system built-in time and attendance code is provided as default, for example late-in, early-out and absence
- show built-in and user-defined time and attendance code which will be used in the attendance report and log correction
- only user-define code can be removed if needed

Name	Description	Date Created	Modify	Delete
1 Unknown				
2 Not yet defined				
3 Late In				
4 Early Out				
5 Absence				
6 Late In/Early Out				
7 Normal				
8 Vacation				
9 Business trip				
10 Sick Leave	Sick Leave code by admin	2011-11-07 14:44:15		

# TAAM (Time and Attendance Manager)

## Delivery Policy for Attendance Report

**1. Report Policy**  
Defines email delivery policy for manager or each user to receive daily, monthly attendance report.

Send reports to the particular person every day at 08:00

Send reports to the particular person at specific day ( 28 ) of every month.

**User List**  
Search Field: Last Name

Name	Department	Extension
batista Eike	/2F/	1000
Stefan Persson	/2F/	1016

Send personal monthly report to each user.

**2. SMTP Server**  
You can specify sending email server(SMTP) configurations.

SMTP Server: 61.33.161.2

Sender Email Address: dacs\_admin@company.com

Server Authentication Required

User ID: admin

Password: \*\*\*\*

To apply this features, select 'Apply' or 'Cancel'

Apply Cancel

AddPac Copyright © AddPac 1999-2011 All Rights Reserved Version 1.1.14

manager level users ( extension ) list who want to receive daily and monthly attendance report

if checked, system will send personal attendance report of each month to extension user

# TAAM (Time and Attendance Manager)

## Attendance Report by Date

**Time and Attendance Manager**  
 Home | Policy | Trip and Vacation | Report Configuration | Report View

**Attendance Report by Date**  
 Shows attendance log for each user and summary information with specified day.

Select Date : 2011-10-19  
 Select Department : All

**Attendance Report by Date (2011-10-19)**

**Type**

Type	Count
Late In	1
Early Out	1
Normal	10

	Username	Department	In	Out	Overtime	Office Hc	Result	Correction Ti	Correct
1	Eike batista	smart management팀	08:05:00	18:05:00	0 hr	10:0...	Normal		
2	Bill Gates	multimedia팀	09:15:00	17:15:00	0 hr	08:0...	Normal	2011-11-...	
3	Larry Ellison	multimedia팀	09:00:00	18:00:00	0 hr	09:0...	Normal		
4	karl Albrecht	smart framework팀	09:00:00	17:00:00	0 hr	08:0...	Early Out		
5	Carlos Slim Helu	smart management팀	09:10:00	19:10:00	0 hr	10:0...	Normal		
6	Lakshmi Mittal	multimedia팀	09:00:00	18:00:00	4 hr	09:0...	Normal		
7	Christy Walton	smart framework팀	09:00:00	18:00:00	0 hr	09:0...	Normal		

You can export to excel or print out for attendance report

attendance summary for each time and attendance code with specified date

administrator may adjust or correct attendance log which system have processed if necessary



# TAAM (Time and Attendance Manager)

## Attendance Report Excel Export

<b>Attendance Report by Date (2011-10-19)</b>							
Username	Department	In	Out	Overtime	Office Hours	Result	Correction Time
Eike batista	smart management	08:05:00	18:05:00	0 hr	10:00:00	Normal	
Bill Gates	multimedia	09:15:00	17:15:00	0 hr	08:00:00	Normal	2011-11-07 14:52:28
Larry Ellison	multimedia	09:00:00	18:00:00	0 hr	09:00:00	Normal	
karl Albrecht	smart framework	09:00:00	17:00:00	0 hr	08:00:00	Early Out	
Carlos Slim Helu	smart management	09:10:00	19:10:00	0 hr	10:00:00	Normal	
Lakshmi Mittal	multimedia	09:00:00	18:00:00	4 hr	09:00:00	Normal	
Christy Walton	smart framework	09:00:00	18:00:00	0 hr	09:00:00	Normal	
Lika Shing	smart framework	09:20:00	18:20:00	0 hr	09:00:00	Late In	
Stefan Persson	smart framework	09:00:00	20:00:00	2 hr	11:00:00	Normal	
Warren Buffett	multimedia	09:15:00	18:15:00	0 hr	09:00:00	Normal	
Amancio Ortega	smart management	09:00:00	21:00:00	3 hr	12:00:00	Normal	
Mukesh Ambani	smart management	09:00:00	18:30:00	0 hr	09:30:00	Normal	

# TAAM (Time and Attendance Manager)

## Attendance Report by Month

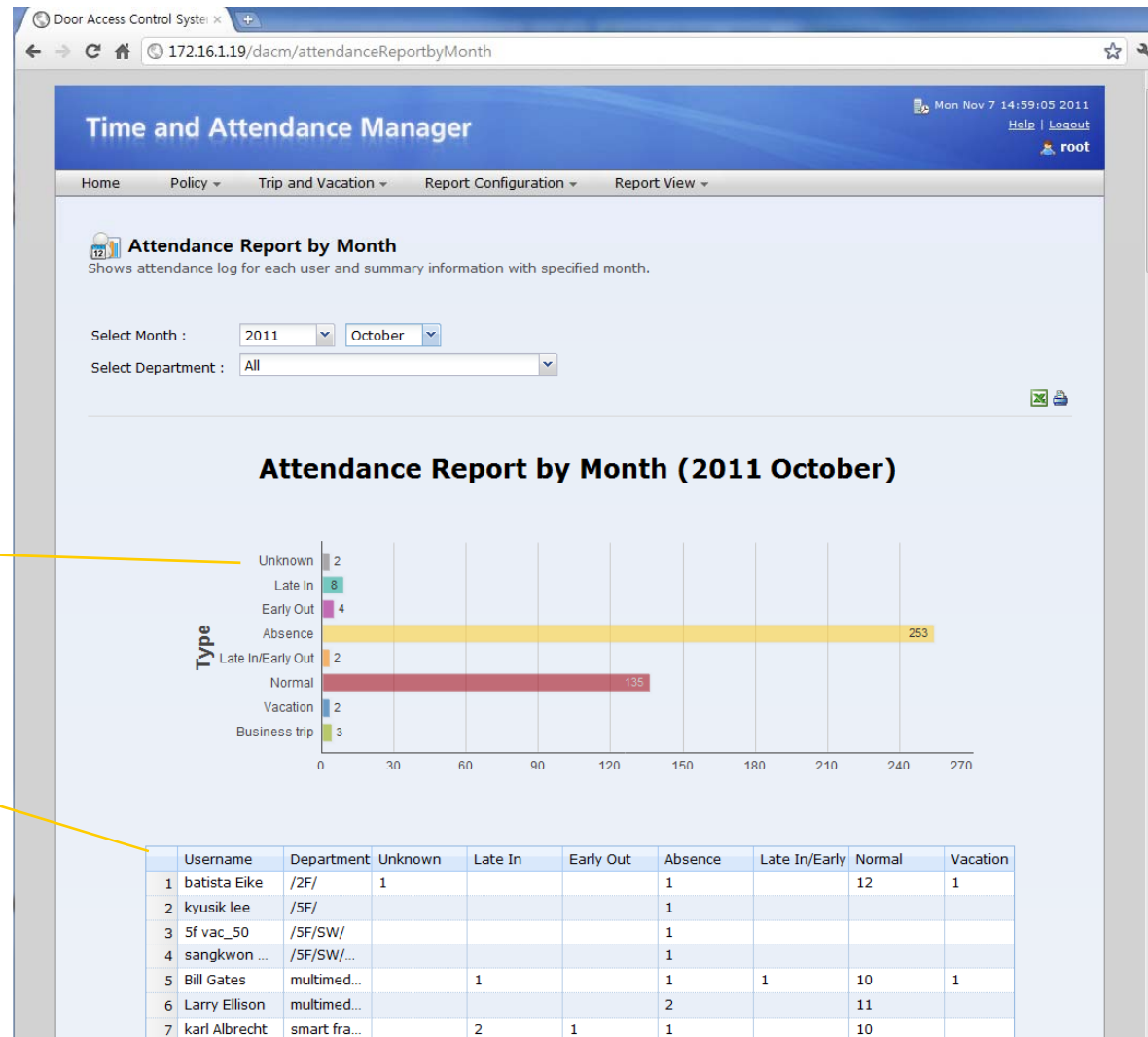

attendance summary for each time and attendance code with specified month

attendance summary for each extension user

# TAAM (Time and Attendance Manager)

## Attendance Daily Report by Month

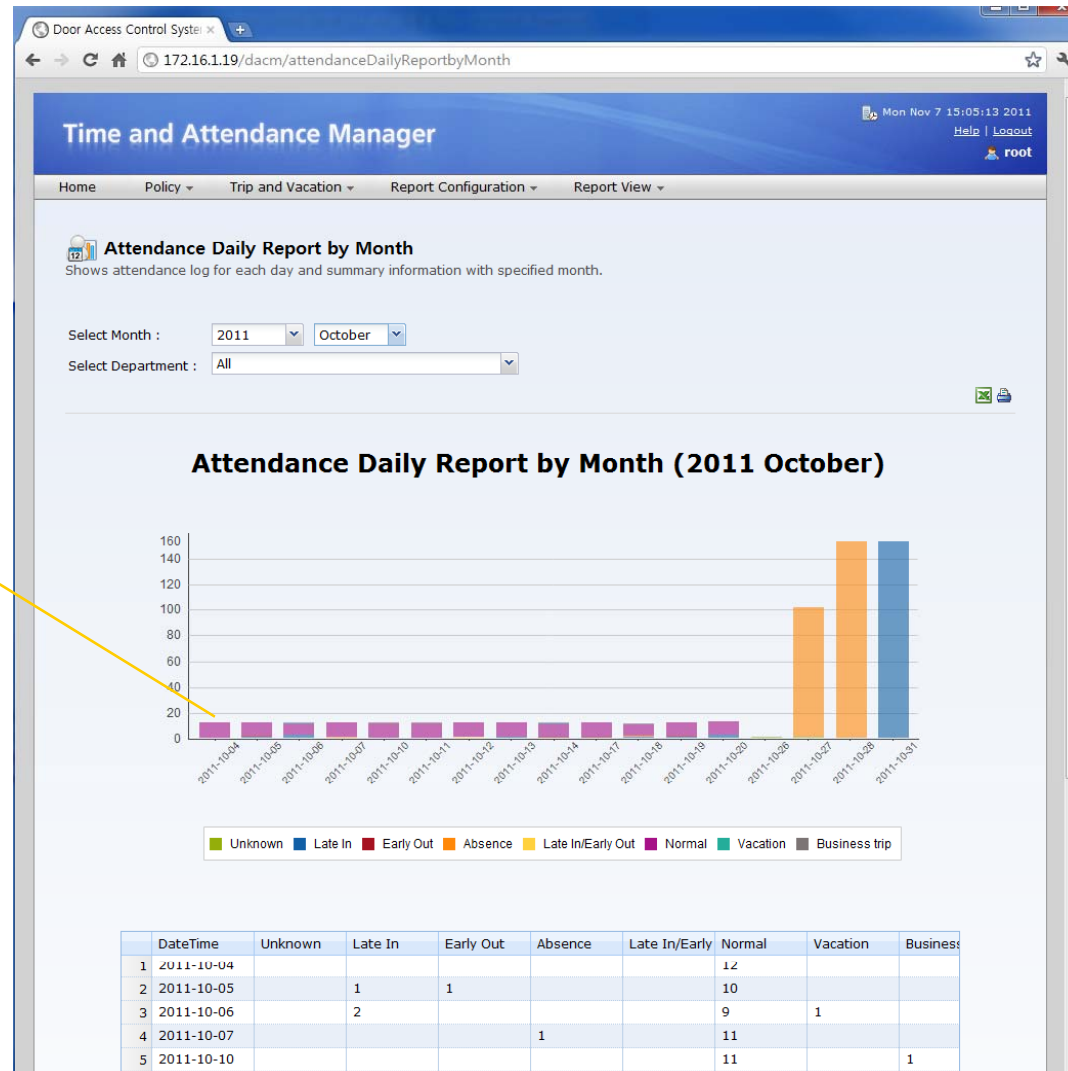

clustered column of attendance summary with time span from first to end of the month

# TAAM (Time and Attendance Manager)

## Attendance Personal Report

**Attendance Personal Report**  
Shows attendance log of each day for the month with specified user.

Select Month : 2011 | October  
Select User : Carlos slim Helu

**Attendance Personal Report (2011 October)**  
Carlos slim Helu (/2F/)

**Type**

Type	Count
Late In	1
Early Out	2
Absence	1
Normal	10
Business trip	1

	DateTime	In	Out	Overtime	Office Hours	Result
1	2011-10-04	09:00:00	18:00:00	0 hr	10:00:00	Normal
2	2011-10-05	09:00:00	18:00:00	0 hr	10:00:00	Normal
3	2011-10-06	09:00:00	18:00:00	0 hr	10:00:00	Normal
4	2011-10-07	09:00:00	18:00:00	0 hr	10:00:00	Normal
5	2011-10-10	09:10:00	19:10:00	0 hr	10:00:00	Normal
6	2011-10-11	09:10:00	19:10:00	0 hr	10:00:00	Normal
7	2011-10-12	09:10:00	19:10:00	0 hr	10:00:00	Normal
8	2011-10-13	09:10:00	19:10:00	0 hr	10:00:00	Normal
9	2011-10-14	09:10:00	17:10:00	0 hr	08:00:00	Early Out

You can specify one extension user for attendance report of the month

attendance summary for time and attendance code of a extension user



# AP-ACS10000 Open API

# Open API

## Open API for 3'rd Party Management System

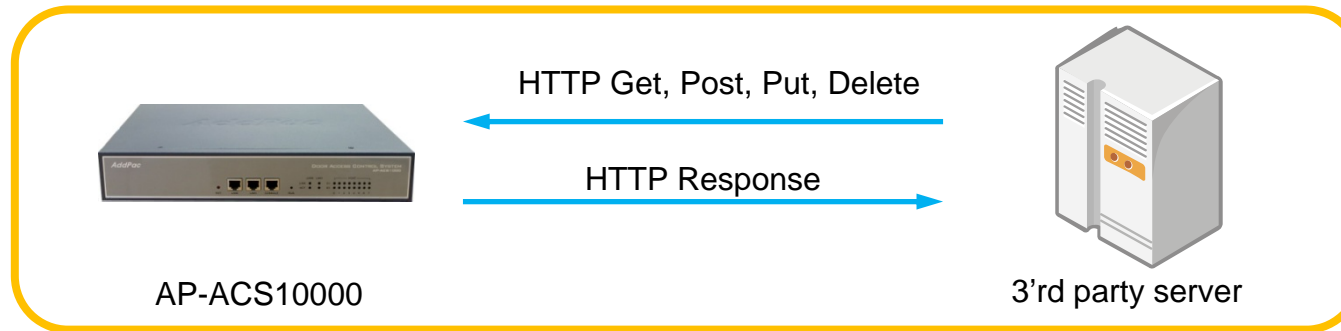





- HTTP based RESTful Open API for Door Access Management
- XML based Flexible and Expandable Message Contents
- Provides More than 40 APIs as Bellow
  - user\_list(GET), user(GET, POST, PUT, DELETE), ...
  - terminal\_list(GET), terminal(GET, POST, PUT, DELETE), ...
  - access\_group(GET, POST, PUT, DELETE), priority (PUT), ...
  - card\_list(GET), card(POST, PUT, DELETE), ...
  - schedule\_template(GET, POST, PUT, DELETE), rule(GET, POST, PUT, DELETE) ,...

# IP Video Door Phone Comparison Table



Model	AP-VAC200	AP-VAC100	AP-VAC50	AP-VAC20
Service Features				
Duplex (Voice)	Full Duplex	Full Duplex	Full Duplex	Full Duplex
Key Pad	3x4 Key Support	3x4 Key Support	3x4 Key Support	3x4 Key Support
LCD	3.5 Inch	3.5 Inch	2inch LCD	Graphic LCD
RF Card	Support	Support	Support	Support
Fingerprint	N/A	N/A	N/A	N/A
Video Codec	H.264/MPEG4	H.264/MPEG4	H.264/MPEG4	H.264/MPEG4
Voice Codec	G.711	G.711	G.711	G.711
Signaling	H.323/SIP	H.323/SIP	H.323/SIP	H.323/SIP
MIC & Speaker Phone	Support	Support	Support	Support
LAN Port	1	1	1	1
PoE(Optional)	Support	Support	Support	Support

# IPNext Hybrid IP-PBX Comparison Table

Model		IPNext190	IPNext187	IPNext185	IPNext180
<b>Service Features</b>					
Registration User Number		150	150	240	100
Concurrent Call User Number		50	50	120 (Up to 4E1)	30
IPv4/IPv6 Dual Stack Support		Support	Support	Support	Support
VoIP Signaling	Internal	SIP	SIP	SIP	SIP
	External	H.323/SIP	H.323/SIP	H.323/SIP	H.323/SIP
Powerful IVR, UMS, Media Service, User Presence Service		Support	Support	Support	Support
RTP Proxy Service (IPv6, Private IP)		Support	Support	Support	Support
LAN Port		2	2	2	2
VoIP Module Slots for PSTN		4 Slots (8 Port Module)	3 Slots (8 Port Module)	2 Slots (8 Port Module)	2 Slots (8 Port Module)
VoIP Interface		FXS,FXO,E1/T1	FXS,FXO,E1/T1	FXS,FXO,E1/T1	FXS,FXO,E1/T1



# IP Video Phone Comparison Table

	AP-VP280	AP-VP230	AP-VP120
			
LCD Size	7Inch Touch Screen	5Inch Touch Screen	4.3Inch
Camera	CMOS	CMOS	CMOS
Video Codec	H.263 MPEG4 H.264	H.263 MPEG4 H.264	H.263 MPEG4 H.264
Signaling	H.323/SIP	H.323/SIP	H.323/SIP
Video MCU	N/A	N/A	N/A
Voice MCU	3-Party	3-Party	3-Party
LAN Port	2	2	2
PoE	Support	Support	Support



# Thank you!

**AddPac Technology Co., Ltd.**  
Sales and Marketing

Phone +82.2.568.3848 (KOREA)

FAX +82.2.568.3847 (KOREA)

E-mail : [sales@addpac.com](mailto:sales@addpac.com)