



AP-M2M300

3G UMTS M2M Device

High Performance 3G UMTS M2M (Machine-to-Machine)
Device Solution



AddPac

AddPac Technology

2014, Sales and Marketing

Contents

- Product Overview
- Hardware Specification
- 3G Module Specification
- APOS Technology
- Network Protocols
- Network Management
- Security Management
- Application Service
- Ordering Information



Product Overview

AP-M2M300 3G UMTS M2M Device

- High Performance RISC & Programmable Architecture
- 3G UMTS based Network Interface
- One(1) Antenna Port & USIM Card Slot Interface
- One(1) 10/100Mbps Fast Ethernet LAN Port Interface
- RS232C (DB9) Port Interface
- RS232/RS485 Interface(Selected by Internal DIP Switch)
- Two(2) Relay Out Interface
- Analog Voltage or Current Interface (Selected by Internal DIP Switch)
- Pulse or Alarm Input Interface (Selected by Internal DIP Switch)
- DC12V External Power Supply, Battery Input Interface (DC12V)
- Powerful Network Protocols (PPPoE, DHCP, Static Routing, etc)
- Firmware Upgradeable Architecture
- Smart Web Manager
- Smart NMS for Large Scale Deployment
- Light and Compact Design with External Power Supply

Product Highlights

AP-M2M300 3G UMTS M2M Device

Powerful 3G UMTS based M2M Device

LAN to 3G Data Network Service
RS232C to 3G Data Network Service

Light and Compact Design

Analog Voltage/Current
Pulse/ Alarm interface

High Performance RISC
Computing Power

Two(2) Relay Out
Interface Port

Broadband IP Networking
With a 10/100Mbps
Fast Ethernet

APOS™ Technology
Firmware Upgradeable Architecture

Smart NMS Large Scale 3G
Routers Management Support

Powerful Network Protocol
Support

Powerful Trouble Shooting &
Debugging Feature Support

One(1) Antenna Port
& USIM Card Slots

AddPac

www.addpac.com

APOS Technology

AP-M2M300 3G UMTS M2M Device

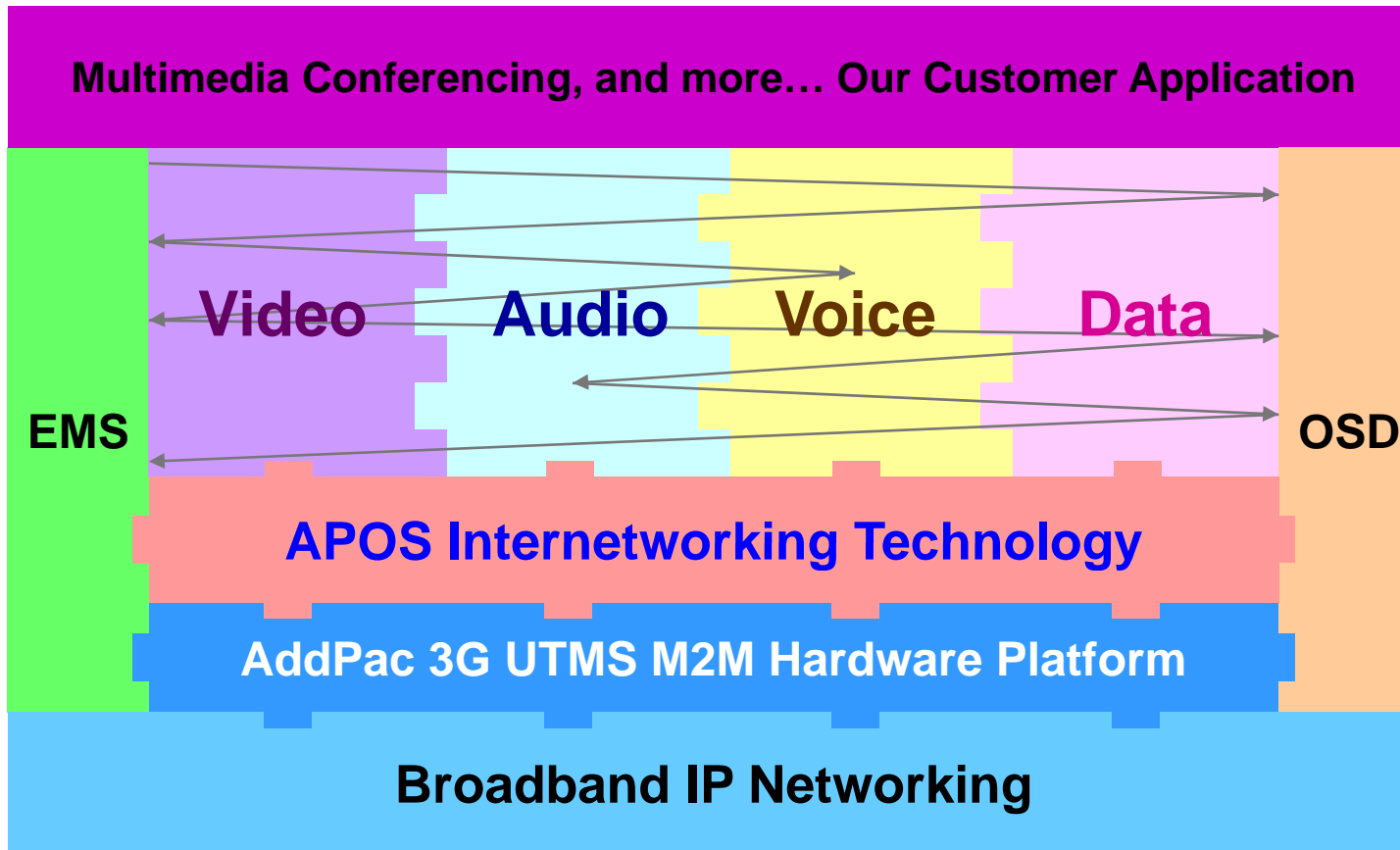

- APOS : AddPac Internetworking Operating System
- OSD : On- Screen Display
- EMS : Element Management System

Hardware Specification

AP-M2M300 3G UMTS M2M Device

RISC
CPU

High-end
DSP

- RISC Microprocessor Computing Power
- 3G UMTS Data Network Interface
- Cellular Network Interface
 - 1-Port USIM Card Slot
 - 1-Port 3G Antenna Interface
- Network Interface
 - One(1) 10/100Mbps Fast Ethernet LAN Interface (RJ45)
 - One(1) RS232C Interface (DB9)
- Terminal Block Interface
 - RS232 or RS485 Interface
 - Analog Voltage or Current Input Interface (1N1, IN2)
 - Pulse or Alarm Input Interface (IN1)
 - Two(2) Relay Out Interface
- DC12V External Power Supply, Battery Power Supply Input

Hardware Specification

AP-M2M300 3G UMTS M2M Device

RISC
CPU

High-end
DSP

Network interface Configuration

Front Side



AddPac

Hardware Specification

AP-M2M300 3G UMTS M2M Device

RISC
CPU

High-end
DSP

Network interface Configuration

Rear Side

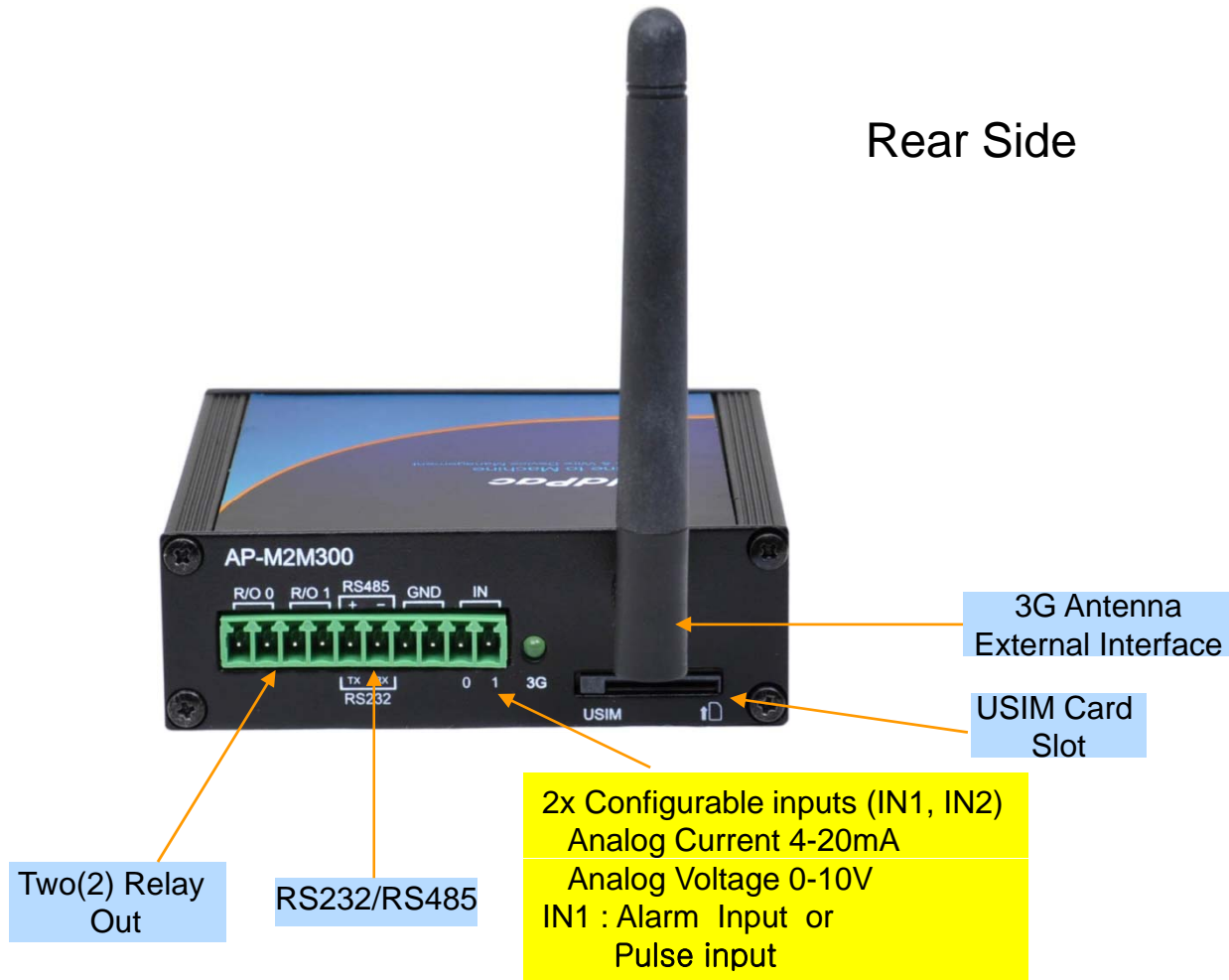

Hardware Specification

AP-M2M300 3G UMTS M2M Device

RISC
CPU

High-end
DSP

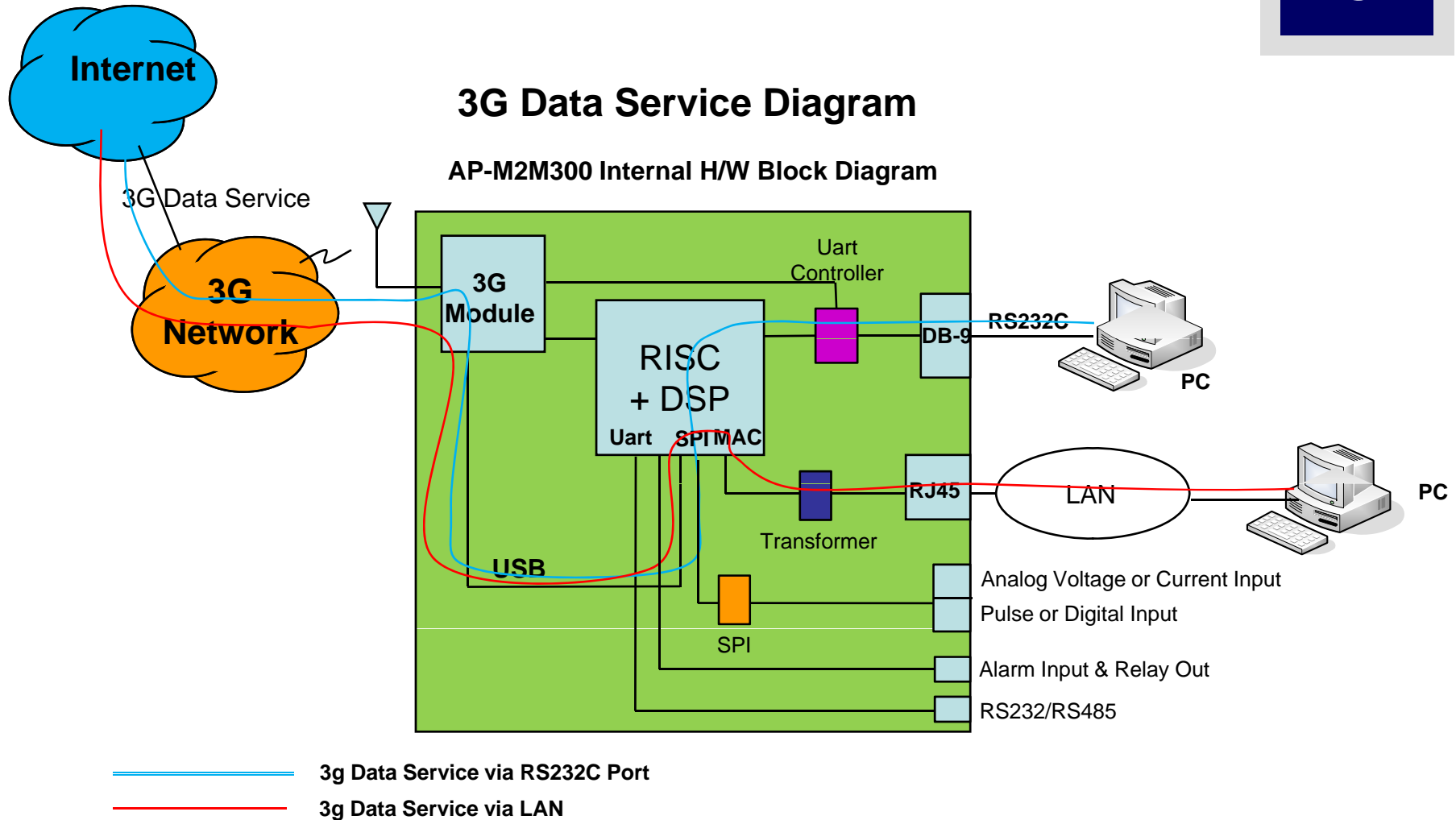

Hardware Specification

AP-M2M300 3G UMTS M2M Device

RISC
CPU

High-end
DSP

AP-M2M300 3G UMTS M2M Device	Basic Specifications
3G Antenna Interface	External 3G Antenna
USIM Card Slot	3G USIM Card Slot
Ethernet Interface	1-Port 10/100Mbps Ethernet Interface(RJ-45)
Serial Interface	1-Port RS232C Serial Interface Interface(DB-9)
Flash Memory	4Mbyte High-speed Flash Memory
Base Memory	32Mbyte High-speed SDRAM
I/O Interface	Analog Voltage (0 ~10V) (IN1, IN2)
	Analog Current (4~20mA) (IN1, IN2)
	Pulse Input or Digital Input (IN1)
	RS232/RS485 Interface
Power Requirement	Power Supply Adaptor / VAC 110~220V, 50/60Hz, 12V/1A
Operating Temperature	0°C ~ 45°C (32 °F ~ 122°F)
Storage Temperature	-40°C ~ 85°C (-40°C ~ 185°F)
Relative Humidity	5% ~ 95% (Non-condensing)
Dimension	28mm x 86mm x 95mm (H x W x D)
Weight (Kg)	0.32Kg

Hardware Specification

AP-M2M300 3G UMTS M2M Device

RISC
CPU

High-end
DSP

2x Configurable inputs (IN1, IN2)
Analog 4-20mA
Analog 0-10V

IN1 : Digital Input or Pulse input
=> CLI Configuration

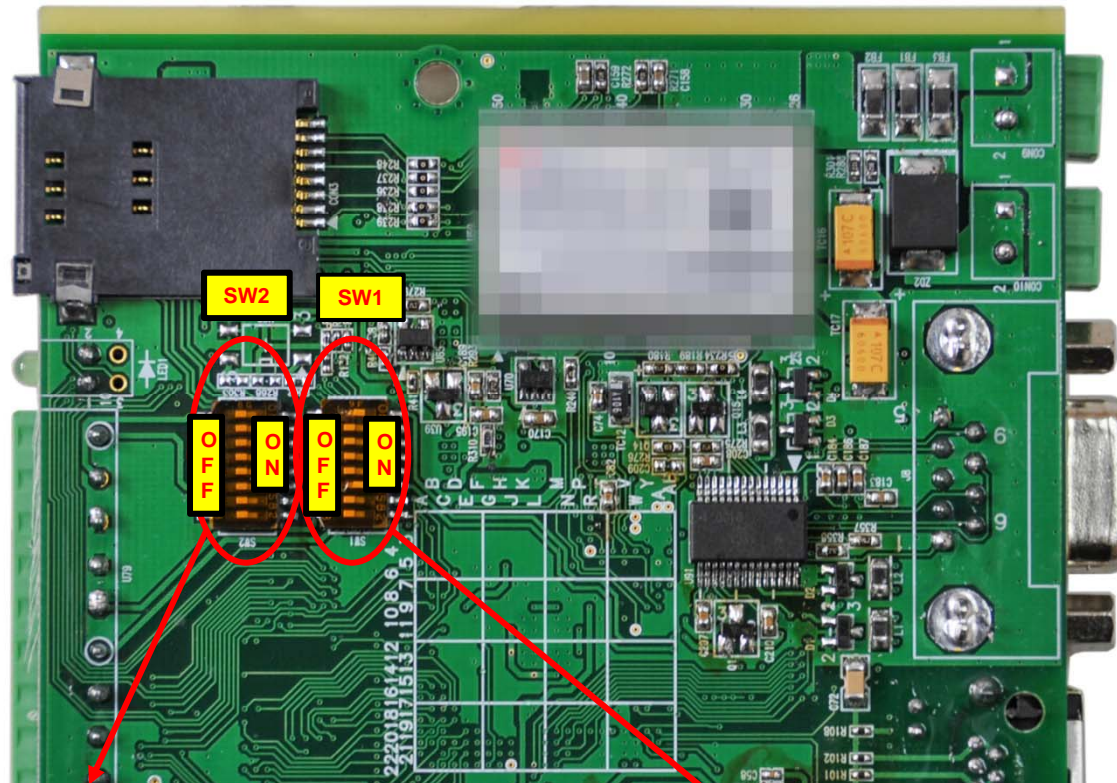

Current/Voltage & Pulse/Digital Input Switch

RS232/RS485 Dip Switch

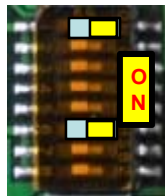

Current

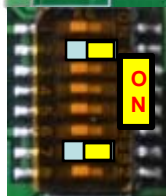

Voltage



Pulse or
Alarm Input

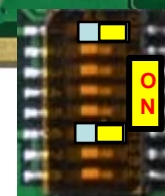

RS232

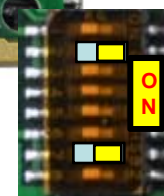

RS485

3G Module Specification

AP-M2M300 3G UMTS M2M Device

- ✓ **3G UMTS/HSDPA/HSUPA Characteristics**
 - Class A User Requirement : data & voice simultaneously
 - UMTS Terrestrial Radio Access FDD
 - 3GPP Release 6 High Speed Packet Access(HSPA)
 - Dual-band Support*(Option)
 - Band I (2100MHz),Band VIII (900MHz)
 - Dual-band Support* (Option)
 - Band II (1900MHz),Band V (850MHz)
 - WCDMA/HSDPA/HSUPA Power Class
 - Power Class 3 (24dBm) for WCDMA/HSDPA/HSUPA Mode
 - PS(Packet Switched) Data Rate
 - HSUPA category 6, up to 5.76Mbps UL
 - HSDPA category 8, up to 7.2Mbs DL
 - WCDMA PS data up to 384kbps DL/UL
 - CS(Circuit Switched) Data Rate
 - WCDMA CS data up to 64Kbps DL/UL

3G Module Specification

AP-M2M300 3G UMTS M2M Device

- ✓ 2G GSM Characteristics
 - Class B Mobile Station
 - Quad-band Support
 - GSM 850MHz, E-GSM 900MHz
 - DCS 1800MHz, PCS1900MHz
 - GSM Power Class
 - Power Class 4 (33dBm) for GSM/E-GSM bands
 - Power Class 1 (30dBm) for DCS/PCS bands

Network Protocols

AP-M2M300 3G UMTS M2M Device

Basic Network Protocols

- ARP, IPv4, TCP, UDP, ICMP, SCTP, IGMP, MLD

Routing Protocol

- IPv4 : Static, Option : RIP v2, OSPF

Service Protocol

- FTP, Telnet, TFTP, DHCP Server/Relay, SNMP Server
- CDP (Cisco Discovery Protocol)
- DNS Resolver, DDNS(nsupdate)
- Bridge
- Syslog

IPv4 Address Configuration

- Fixed (Static)
- DHCP
- PPPoE

Miscellaneous

- Cisco Style CLI
- Standard & Extended IPv4 Access List
- Multi-level User Account Management
- IP accounting
- STUN Client

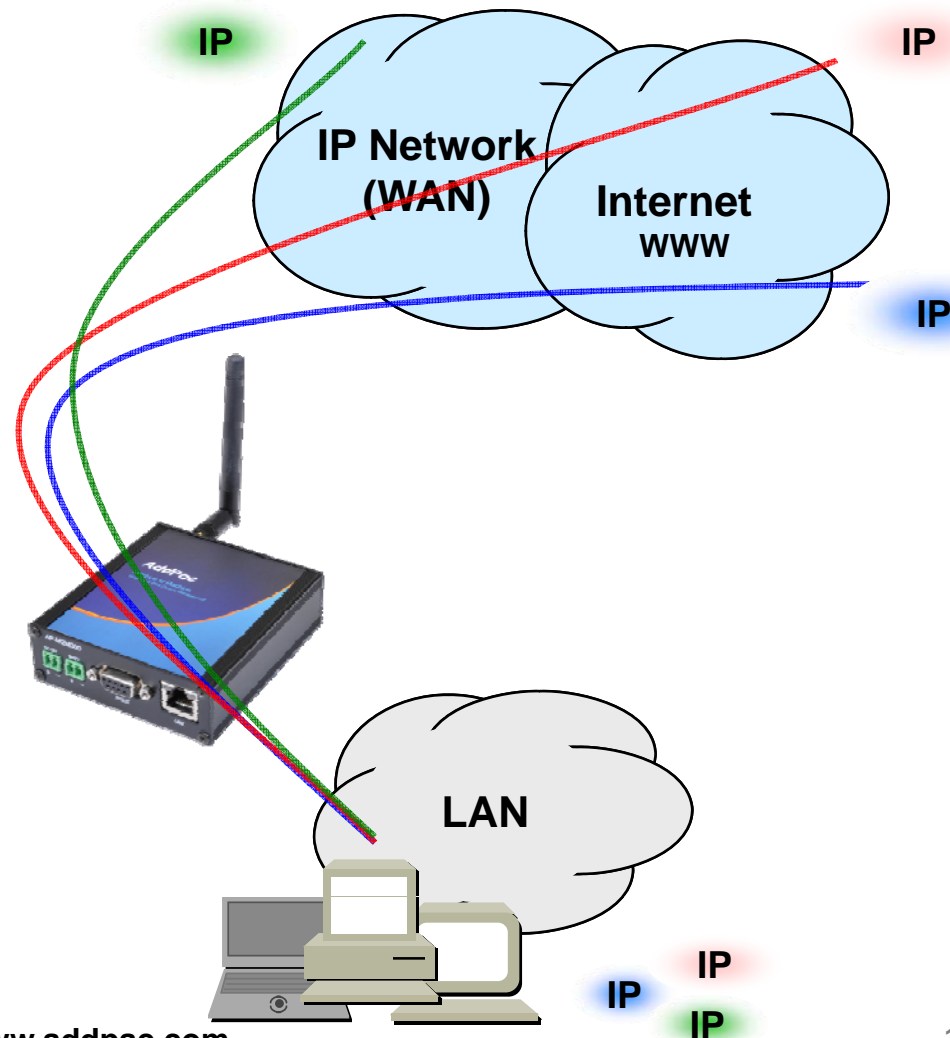

Network Management

- SNMP

- Standard Simple Network Management Protocol(SNMP) Agent support
- MIB v1 and v2 Support

- Web-based Management

- Smart Easy Setup
- Standard Voice Interface
- Standard PSTN Back-up Interface

- Watch-dog Function

- Hardware, Software watch-dog services

- Remote Management

- Telnet
- Rlogin

- Auto Upgrade Service

- HTTP server based APOS image and configuration file auto-upgrade support

- Batch Job Function

- Text based script downloading

- Interoperable with Smart NMS Service

- AddPac Smart NMS (Network Management System)

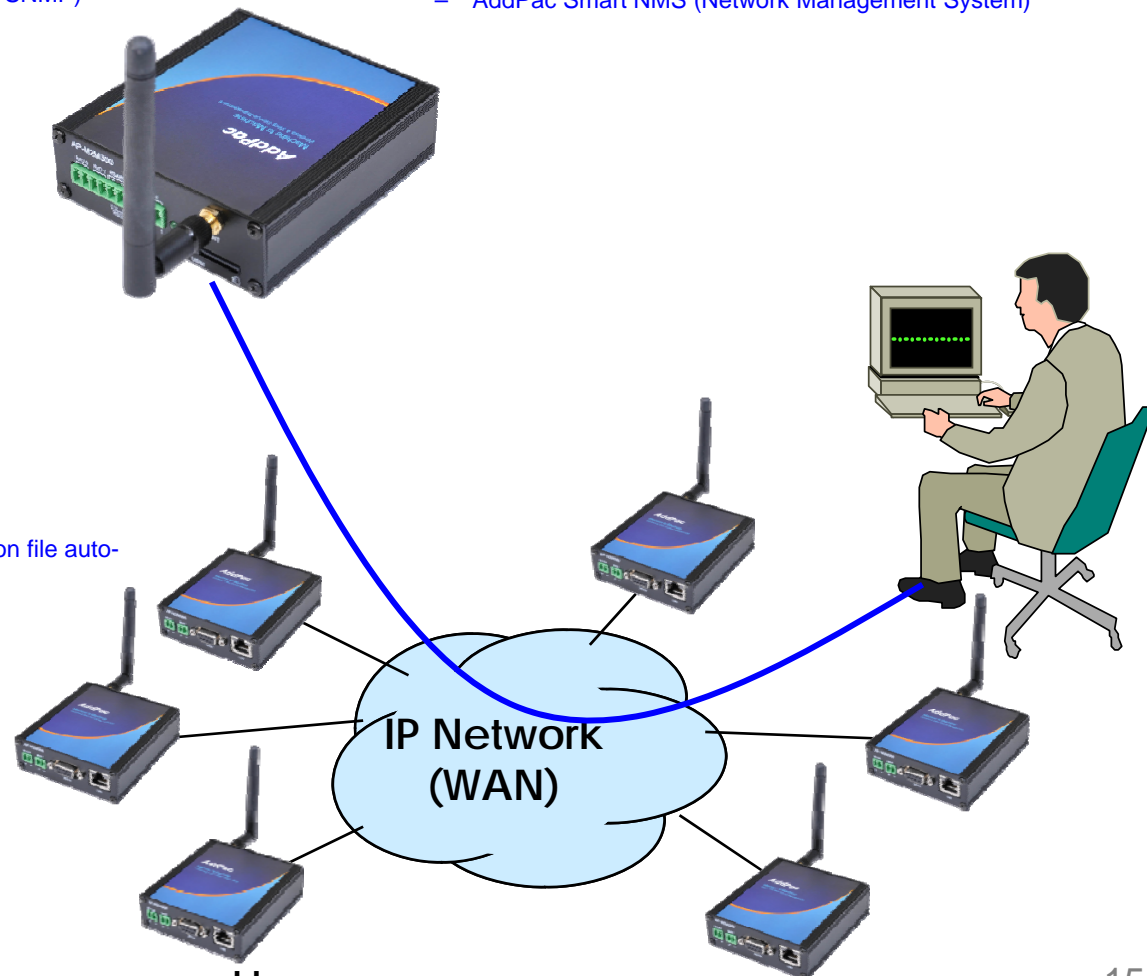

Security Management

AP-M2M300 3G UMTS M2M Device

- IP packet filtering
- IP access list
- User authentication function
 - Password Authentication Protocol (PAP)
 - Challenge Handshake Authentication Protocol (CHAP)
- Enable/Disable specific protocols
- Auto-square connect of Telnet session
- Account Management function for multi-level user
- SNMP/TELNET/FTP/HTTP/TFTP port assignment function
- SNMP/TELNET/FTP access list management
- Boot mode security checking function

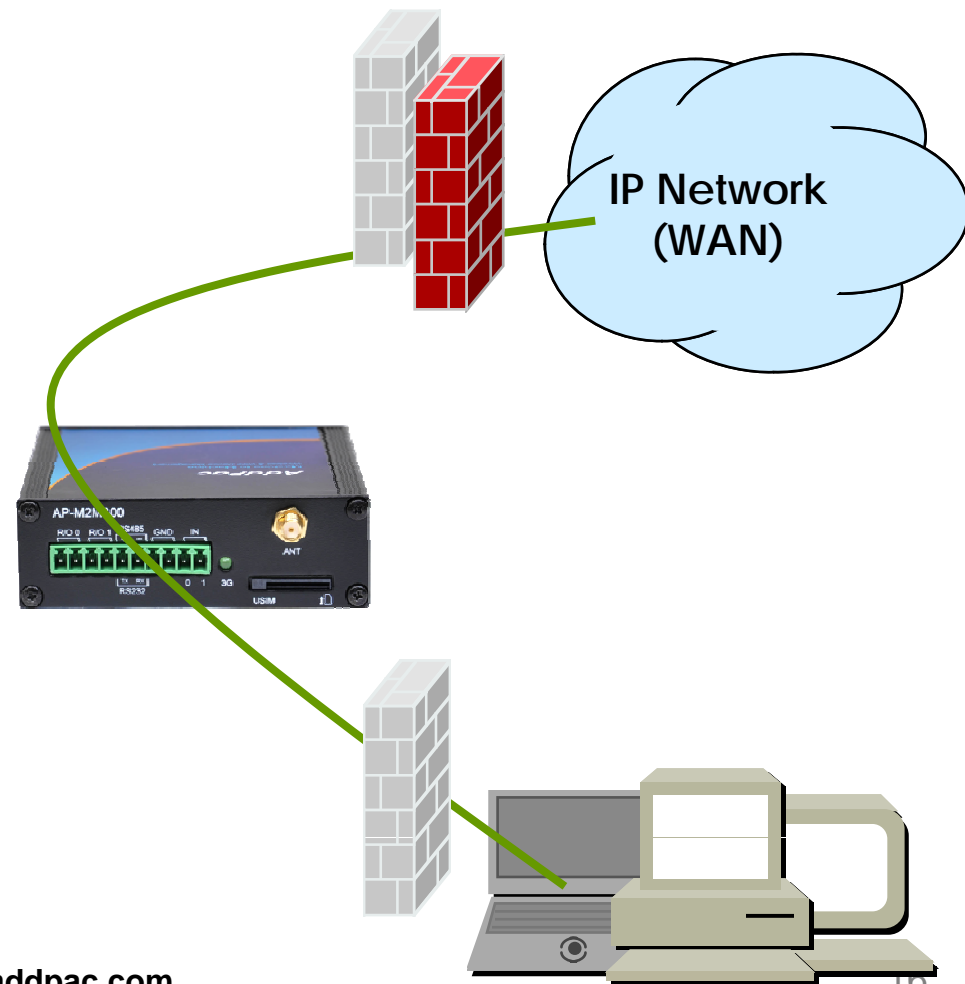

M2M Application (Example : ATM Machine)

AP-M2M300 3G UMTS M2M Device

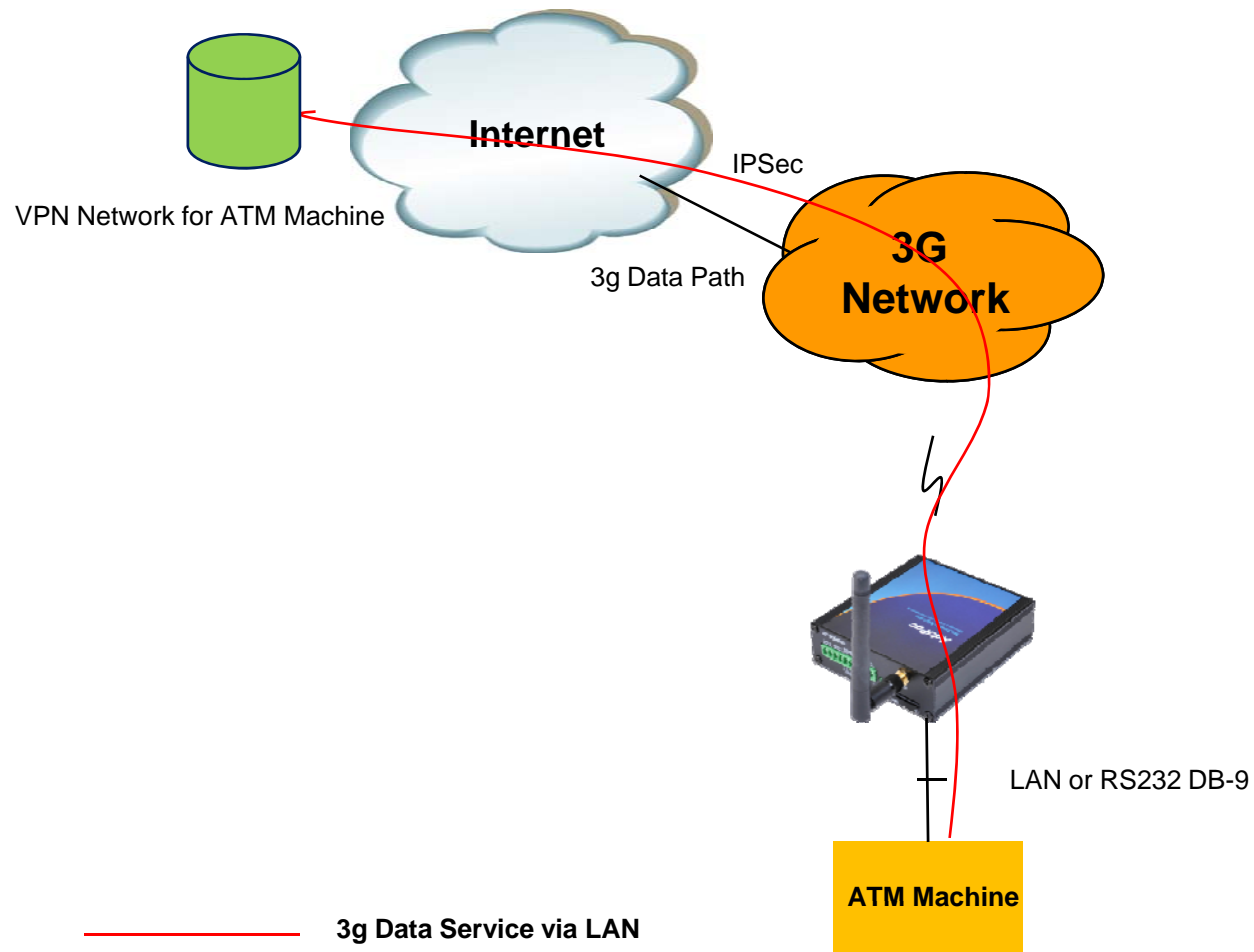

Ordering Information

- **AP-M2M300 3G UTMS M2M Device Hardware**
 - AP-M2M300 3G UMTS M2M Device Main Body
 - RISC Microprocessor with High-end Programmable DSP Architecture
 - 1-Port 3G Interface (Antenna, USIM Card Slot)
 - 1-Port 10/100Mbps Fast Ethernet(RJ45)
 - 1-Port RS232C Serial Interface (DB-9)
 - I/O Interface : Relay Out, Alarm Input, Analog Voltage, Current Input
 - Including Network Cable, Antenna & Ext. Power Supply, etc.
- **Built-in APOS Internetworking Software for AP-M2M300**
- **Including 1 Year Hardware Warranty**
- **Product Documents**
 - Install and Operation Guide (PDF)
- **Pricing**
 - AddPac Technology Regional Sales Manager
 - Authorized Sales and Marketing Representatives
 - Please Contact www.addpac.com

3G M2M Device Series

Thank you!

AddPac Technology Co., Ltd.
Sales and Marketing

Phone +82.2.568.3848 (KOREA)

FAX +82.2.568.3847 (KOREA)

E-mail sales@addpac.com