



AP600S VoVPN Gateway



December 2004

Technical Sales and Marketing

AddPac Technology

www.addpac.com

AP600S VoVPN Gateway Product Overview

APOS Internetworking Protocol Stack

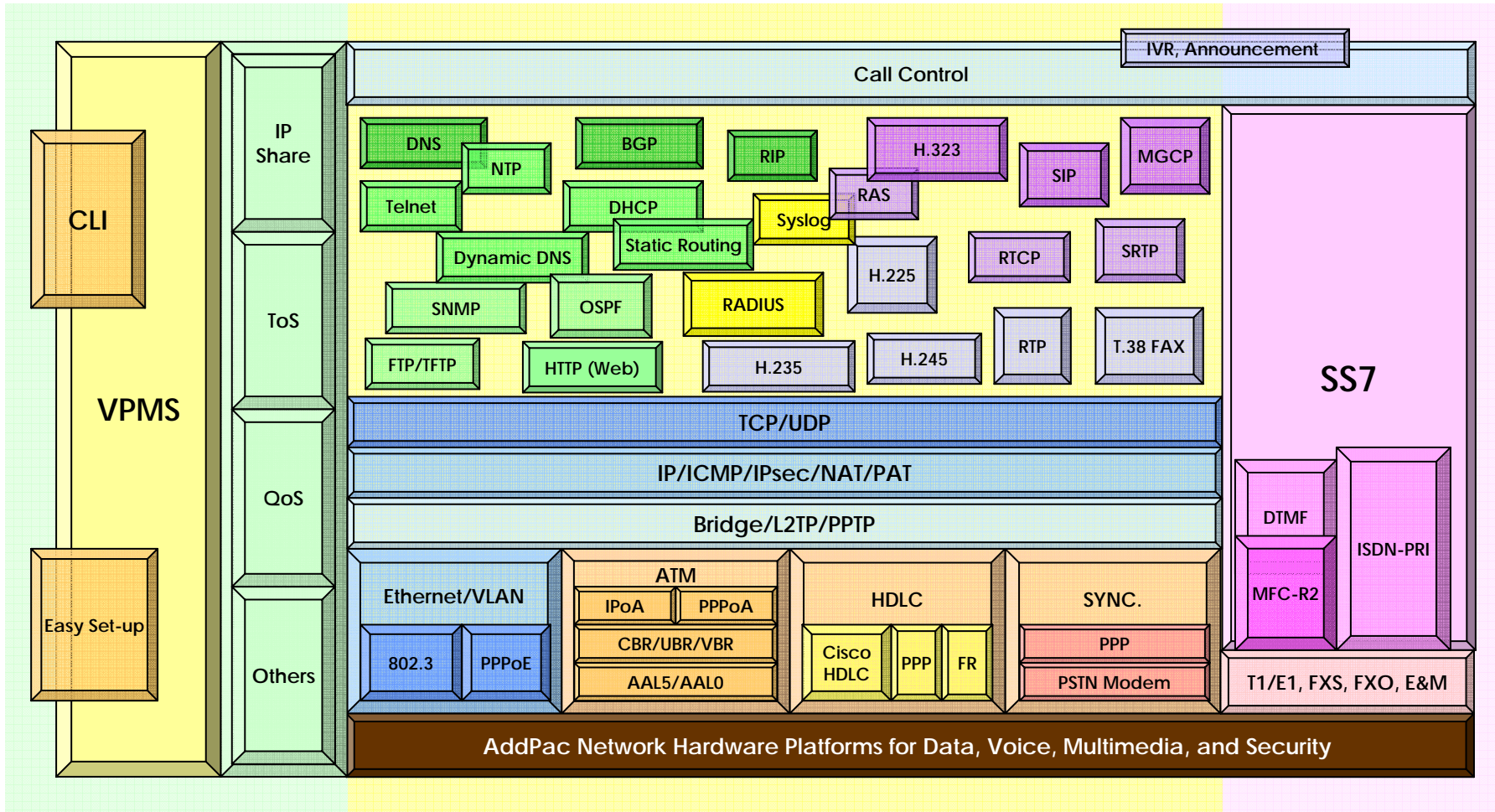

AP600S VoIP Gateway Product Overview

APOS Internetworking S/W World

• APOS Internetworking Software World

- AddPac Operating System (APOS)
- Support Industry Standard
- Integrated Networking Protocols
- Optimized Performance & Functionality
- Easy to use, Installation, and Maintenance

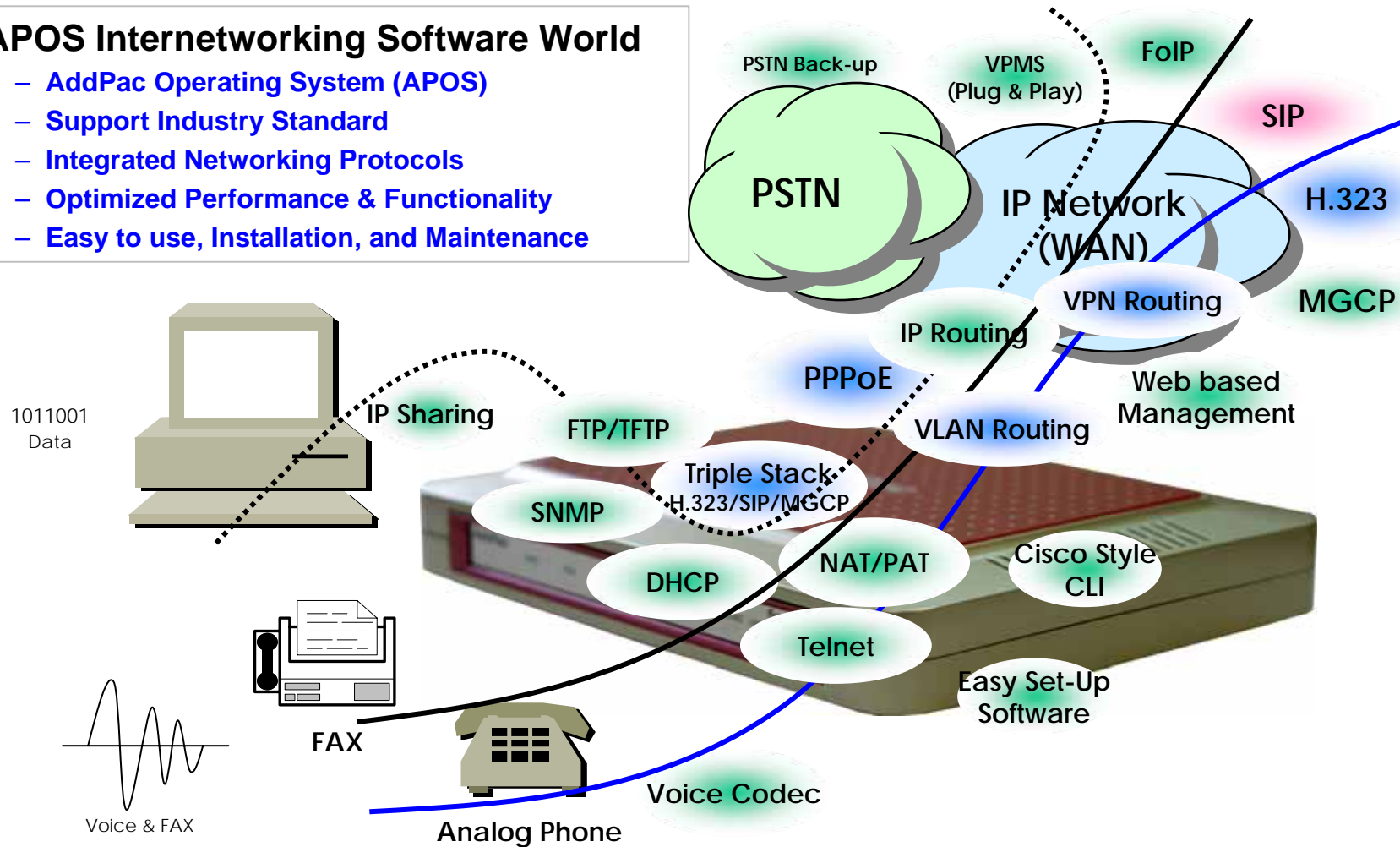

AP600S VoVPN Gateway Product Overview

APOS Internetworking S/W World (cont.)

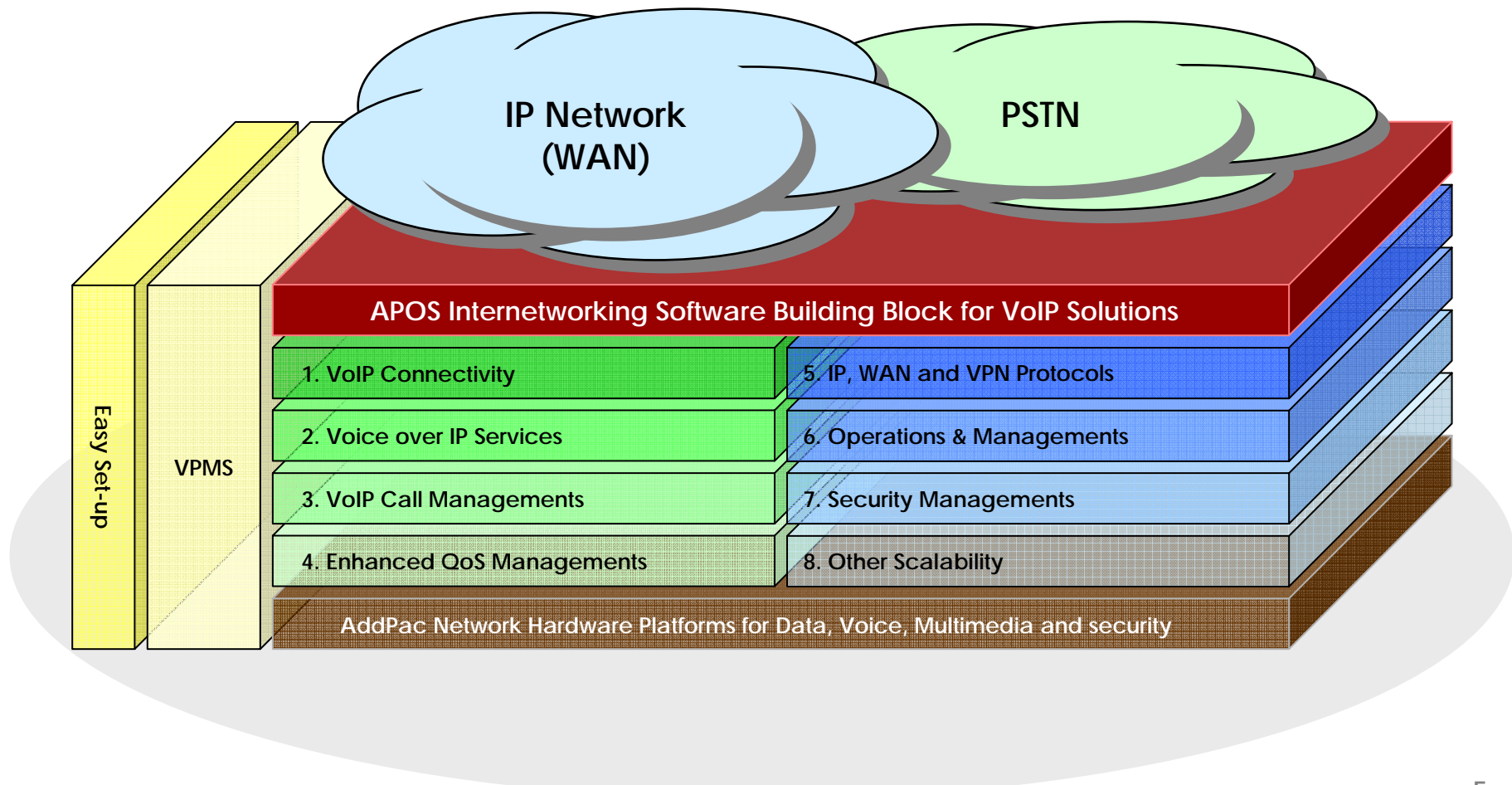

AP600S VoVPN Gateway Product Overview

Voice over IP Service

- **H.323, SIP, and MGCP Triple Stack**
 - Concurrent Triple VoIP Stack Software
 - Single Hardware with Three VoIP Service
 - New APOS-NX Version
- **H.323**
 - ITU-T Standard H.323 v3 Support
 - Support H.245 Tunneling
 - Including H.235 Security Features
- **SIP**
 - IETF RFC3261 or RFC2543 SIP Standard
- **MGCP**
 - IETF RFC2705bis-02 Standard MGCP 1.0

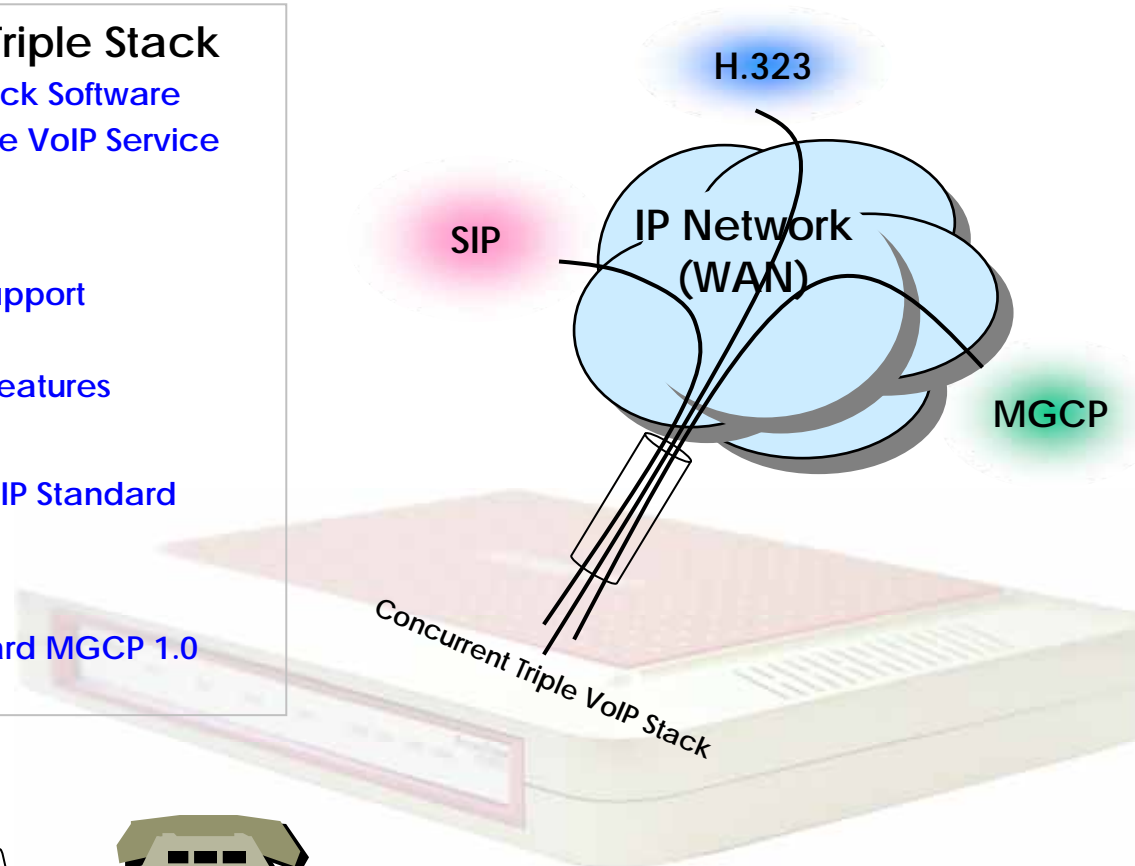

AP600S VoVPN Gateway Product Overview

Voice over IP Service (cont.)

• H.323

- Fast connect, normal connect support
- H.245 tunneling support
- Q.931 response message setting for inbound VoIP calls
- H.245 logical channel open timing selection function
- Start H.245 procedure support
- DTMF / Hook flash relay with H.245 alphanumeric / signal
- Secondary gatekeeper support
- Gatekeeper assignment according to the domain name
- Gatekeeper discovery with multicast
- Lightweight RRQ support
- Signaling TCP port assignment
- Resource threshold setting with RAI
- H.235 clear-token, crypto-token support
- canMapAlias support
- Technical prefix (supported prefix) support
- Public IP assignment in NAT environment

• SIP

- Gateway-based / Endpoint-based registration support
- Secondary proxy-server assignment function
- SIP signaling port change function
- SIP proxy server assignment according to the domain name
- T.38 real-time fax relay support
- DTMF relay support with RFC2833 / OPTION message
- Re-INVITE support

• MGCP

- Secondary call agent assignment function
- Default package assignment
- Announcement Server Package, Generic Media Package, Handset Package, Line Package, Trunk Package support
- MGCP call agent assignment according to the domain name
- T.38 real-time fax relay support
- DTMF relay support based on RFC2833

AP600S VoVPN Gateway Product Overview

Voice over IP Service (cont.)

• Voice Codec

- G.711 A-Law, G.711 U-Law
- G.726 r16, G.726 r32
- G.729A
- G.723.1 r63, G.723.1 r53
- VAD (Voice Activity Detection) function support
- DTMF relay support (H.323, SIP, MGCP common) based on RFC2833

• RTP

- Redundant RTP packet transmission in case of severe packet loss
- Dynamic jitter buffer management and RTP packet jitter and loss compensation with heuristic & DSP error concealment
- Static jitter buffer setting support
- Voice frame per RTP packet number control for each codec
- In-band ring-back tone support
- Virtual ring-back tone support
- Tone parameter change support

• FAX

- Fax relay mode supporting T.38, inband-T.38, bypass mode
- Lost packet compensation with redundant setting in case of T.38 fax relay
- Fax relay mode, rate setting for remote end

VoIP

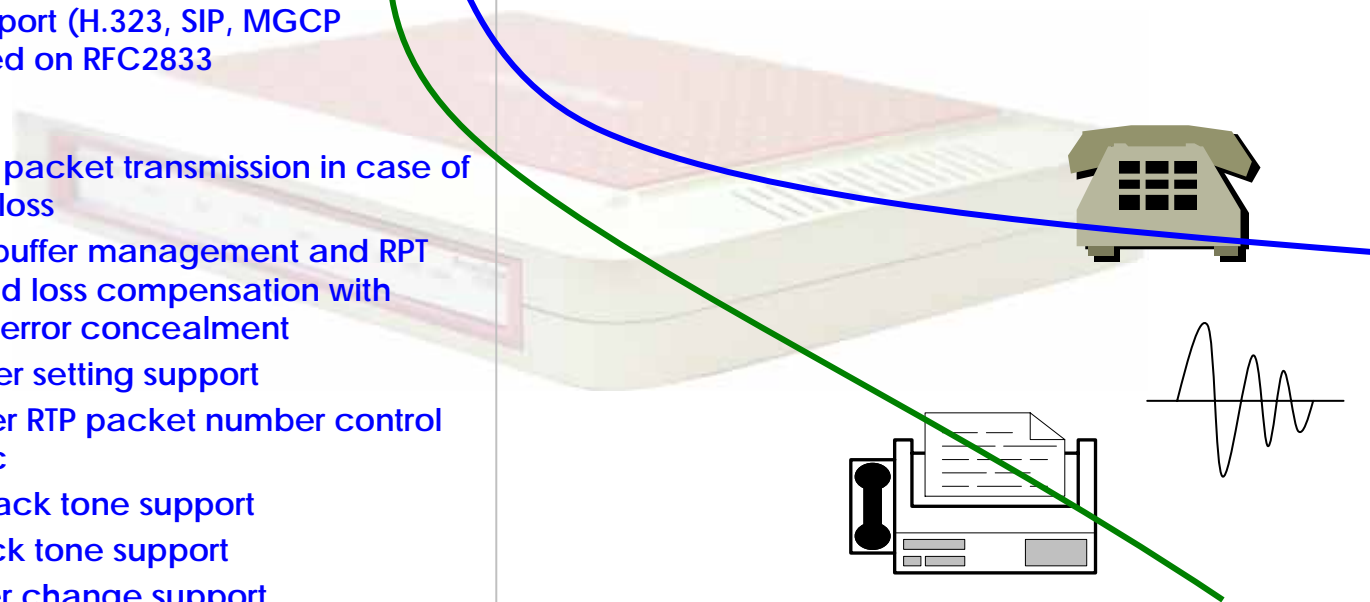

AP600S VoVPN Gateway Product Overview

VoIP Call Managements

• VoIP Call Controls

- Hot line connection function with PLAR (Private Line Auto Ring Down)
- Leased line emulation function
- Connection monitoring function
- Fault tolerant with Redundancy and Call Distribution among Gateways for load balancing
- Call attempt with IP address
- H.323, SIP, MGCP inbound call connection for each voice port
- Multiple E.164 setting for one voice port
- One E.164 or digit pattern can be assigned to more than one voice port
- Hunting with Longest match/ priority/ sequence/ random
- One stage call setup by Digit forwarding
- Call barring with specific digit patterns
- Calling and called number conversion for PSTN outbound calls
- PSTN rerouting in case of VoIP call attempt failure

• VoIP Call Controls (cont.)

- Call transfer for internal calls
- Call pickup for internal calls
- Calling and called number conversion for VoIP outbound calls
- Calling and called number conversion for VoIP inbound calls
- Fax broadcasting call control

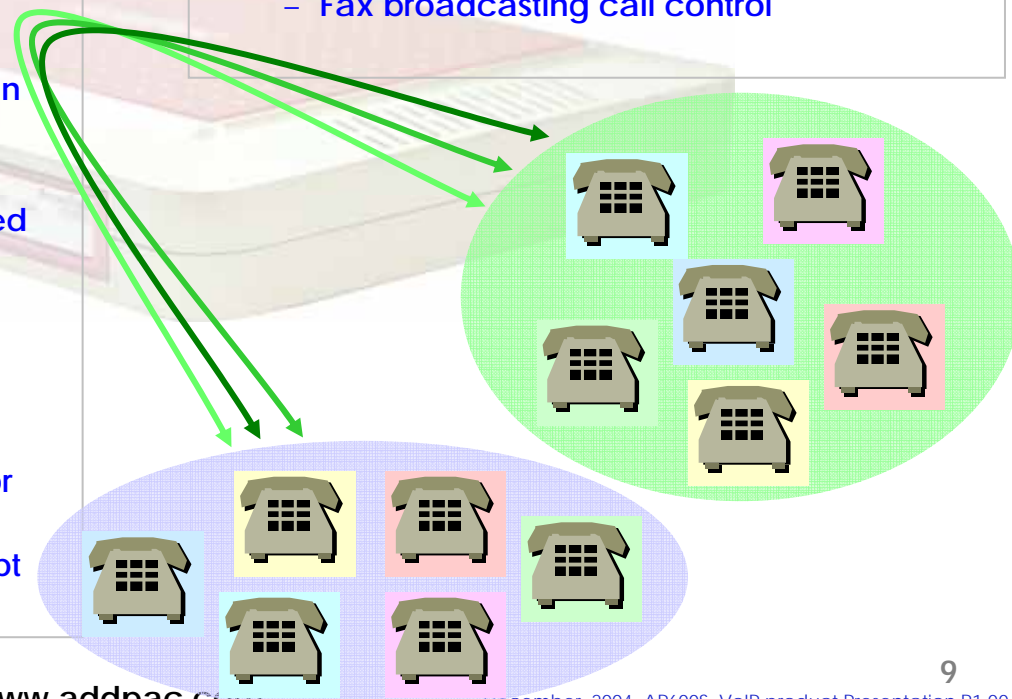

AP600S VoVPN Gateway Product Overview

Enhances QoS Managements

- Enhances **Transmit** Voice QoS Features

- Voice Traffic Priority Queuing
- QoS Service Profiling
- Providing Virtual Network Transmit Algorithm
- Real-time Voice Traffic QoS Support
- RTP Packet Transmit Interval Control
- Supporting RTP Packet Redundancy Scheme
- IP Header Control such as ToS, Diffserv

- Enhances **Receive** Voice QoS Features

- Dynamic Jitter Buffer Management
- Error Concealment
- Support T.38 FAX Data Error Recovery Scheme

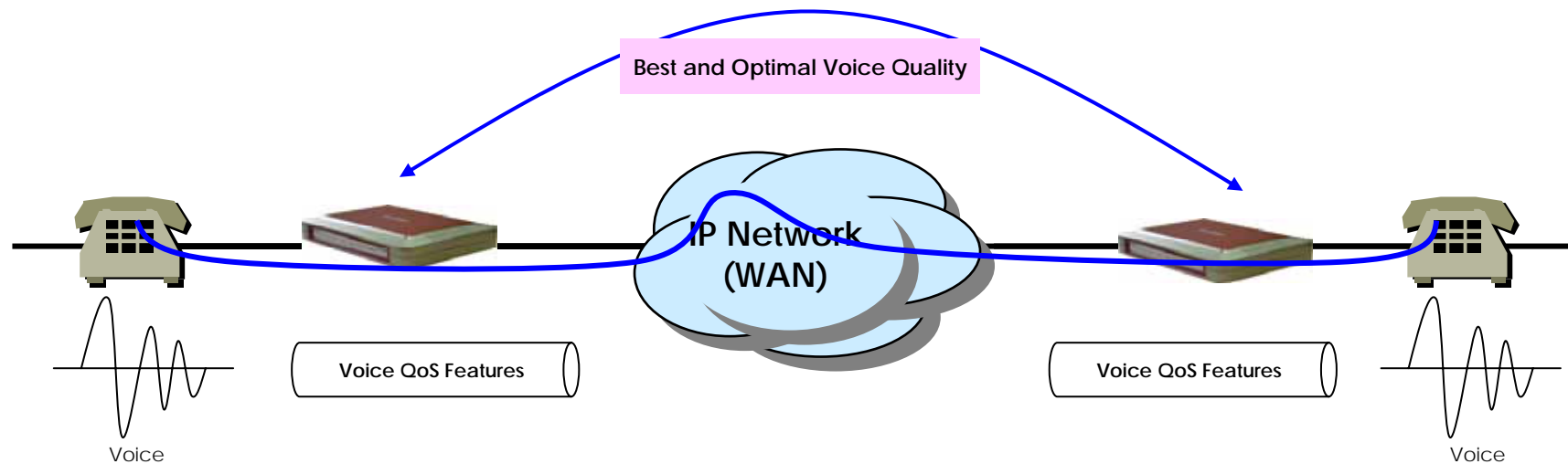

AP600S VoVPN Gateway Product Overview

Enhances QoS Managements (cont.)

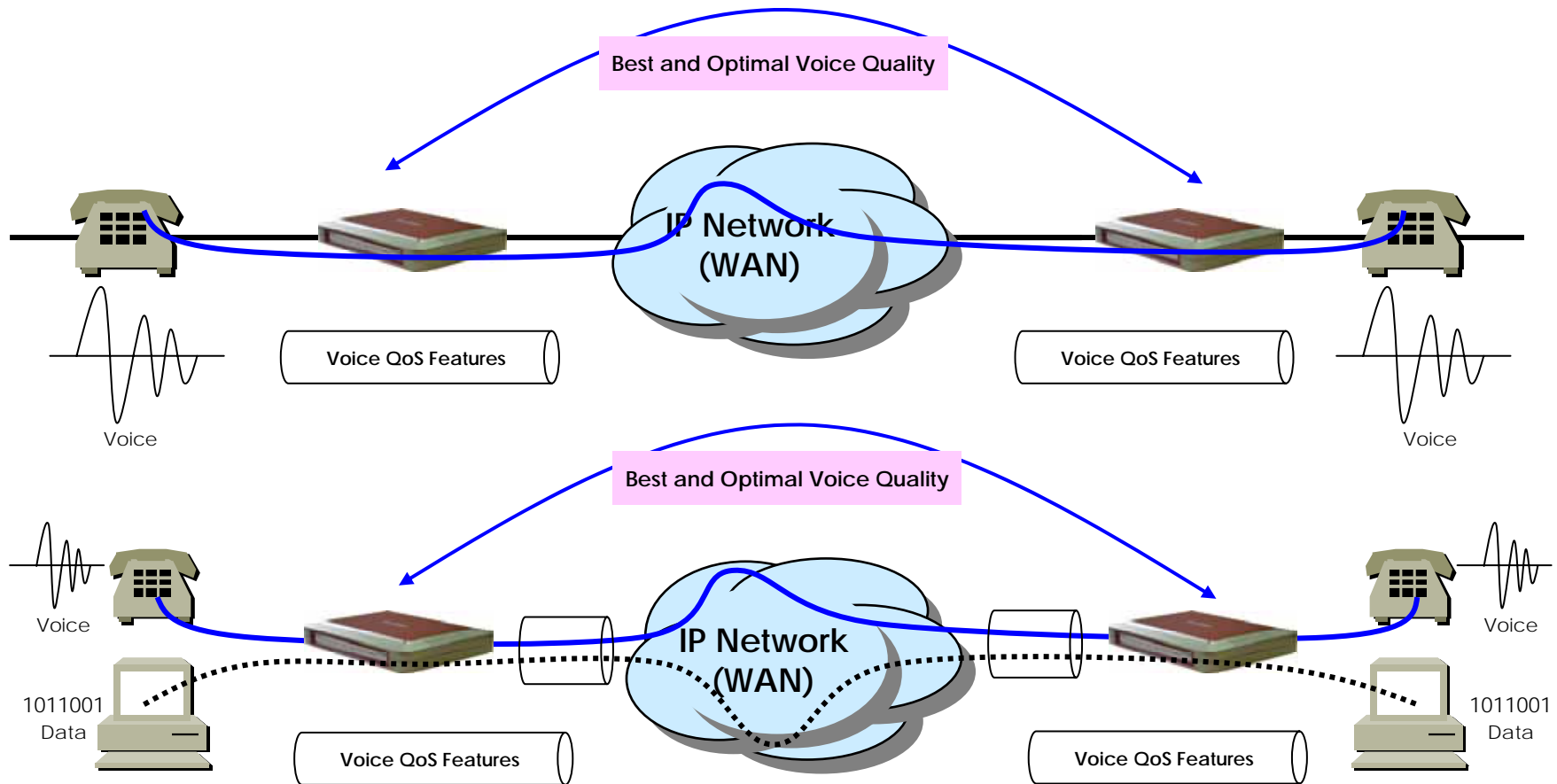

AP600S VoVPN Gateway Product Overview

Enhances QoS Managements (cont.)

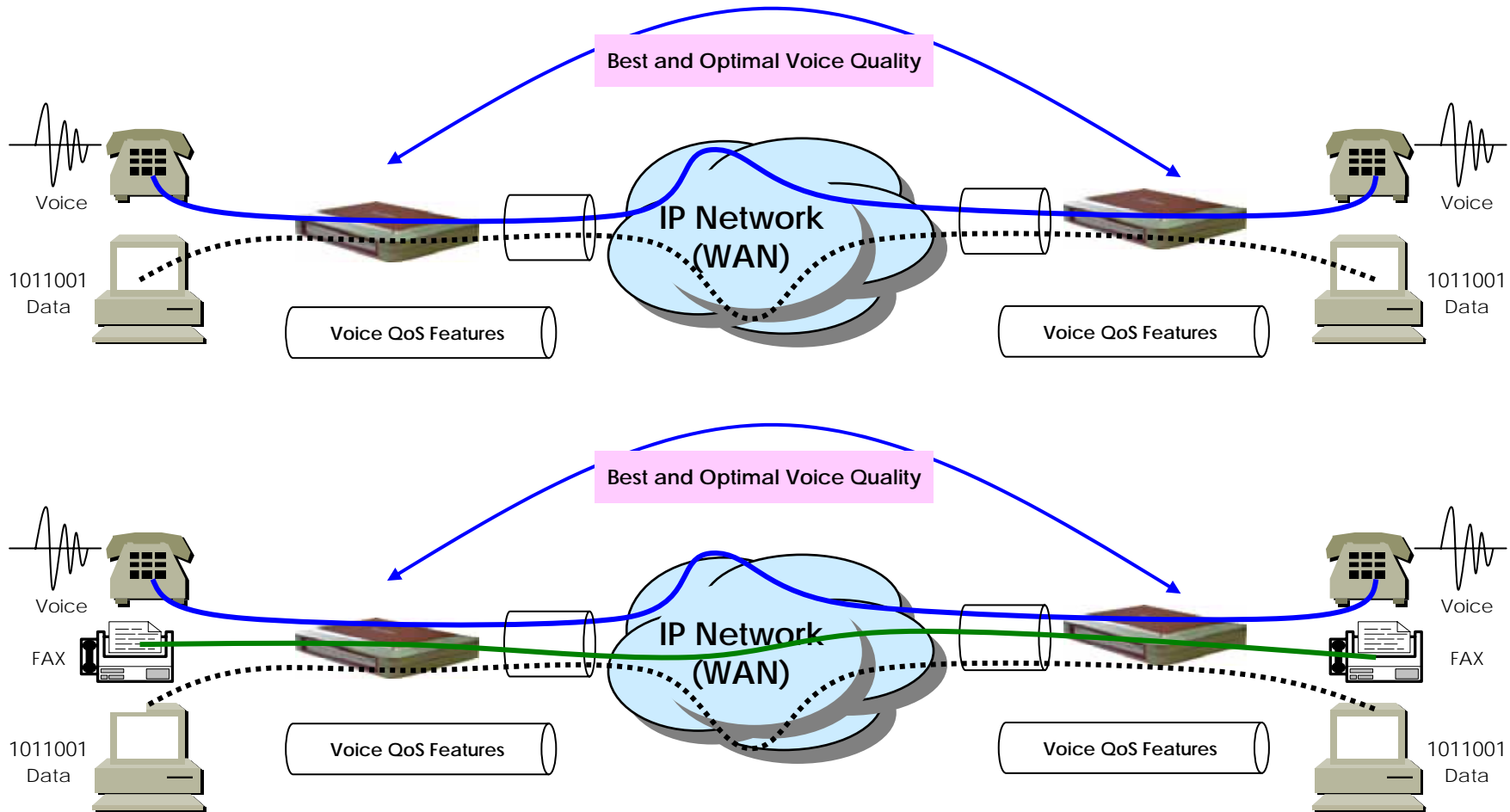

AP600S VoVPN Gateway Product Overview

Enhances QoS Managements (cont.)

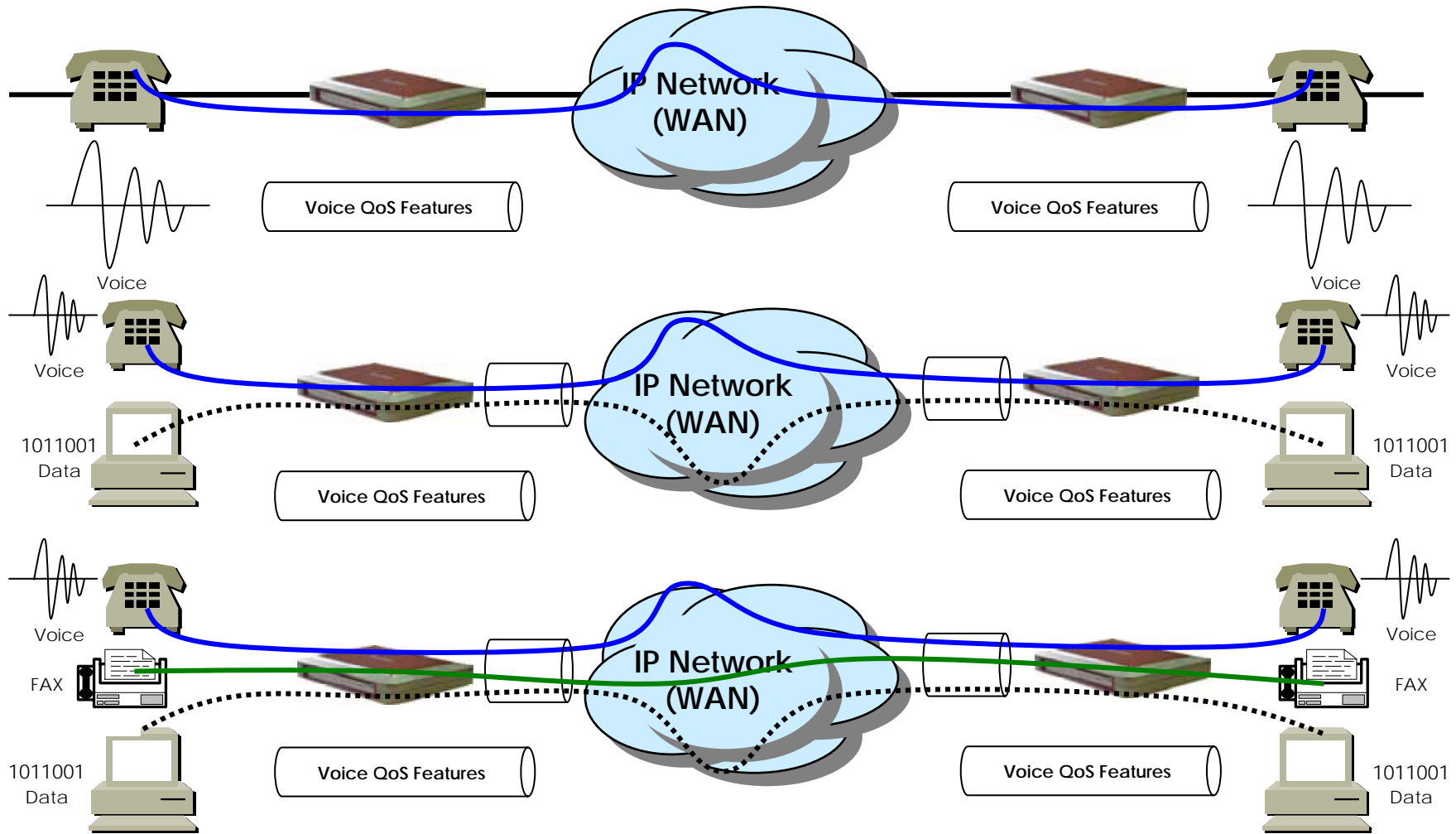

AP600S VoVPN Gateway Product Overview

IP and WAN Protocols

- IP Routing Protocols

- Multi-protocol Internetworking Services
- Static IP routing
- RIP v1/v2 (opt.)
- OSPF v2 routing protocols support (opt.)
- Transparent Bridging (IEEE Spanning Tree Protocol)

- WAN Protocols

- Point-to-Point Protocol over Ethernet (PPPoE)
- Dynamic Host Configuration Protocol (DHCP) Networking

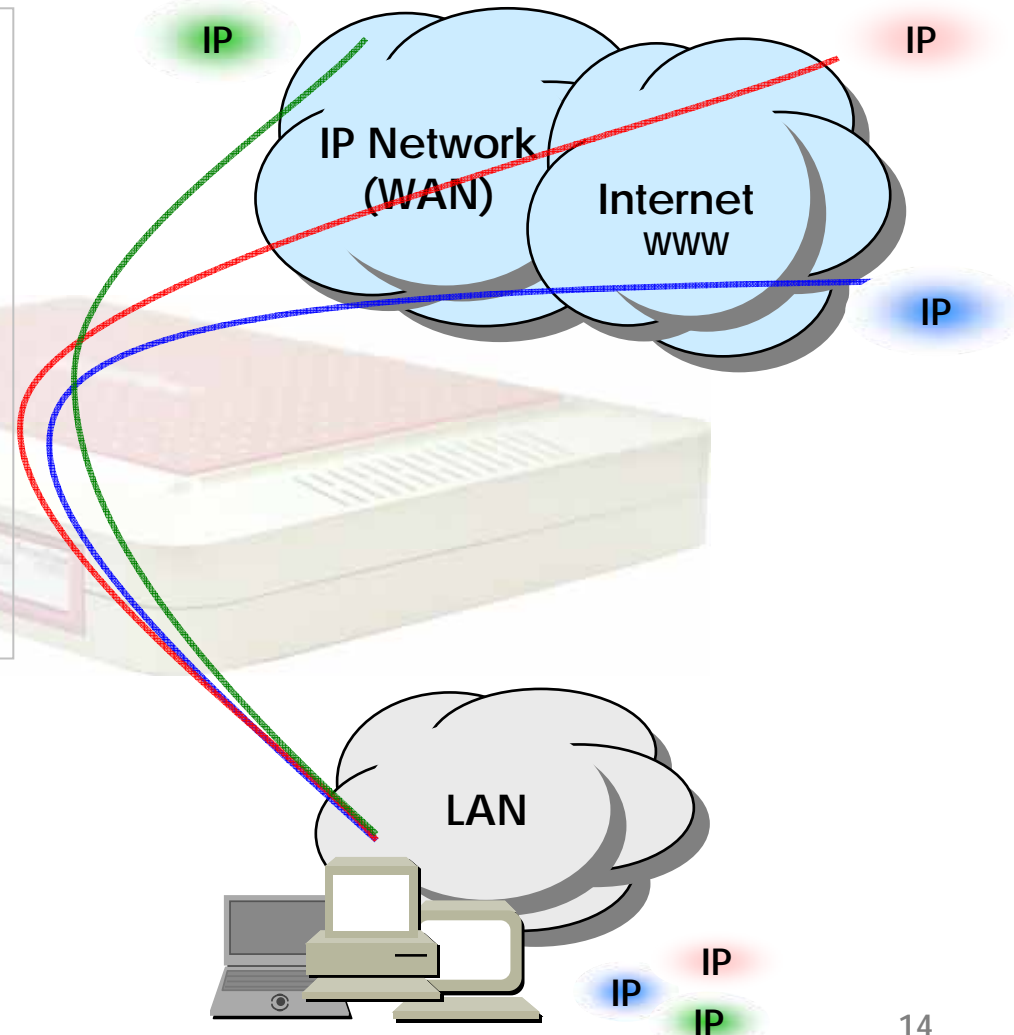

AP600S VoVPN Gateway Product Overview

VPN Protocols (continue..)

• VPN Protocols

- Authentication Algorithm : MD5, SHA-1, HAS-160
- Key Management: IKE Standard
- CA Authentication :ID/Password , LDAP, X.509
- IP Encapsulating Security Payload (ESP)
- Authentication : PAP, CHAP, MS-CHAP*, RADIUS*
- Tunneling Protocol : PPTP, L2TP, IPSec
- IKE Encryption : DES, 3DES, AES, blowfish, cast
- IKE hash : MD5, SHA1
- IKE Authentication : Preshared-key, RSA-sig*
- IKE Key Exchange : DH group 1(768), DH group 2(1024), DH group 5(1536)
- IKE lifetime : Second/Byte
- IKE Phase 1 : Main-mode, Aggressive-mode
- IKE Phase 2 : Quick-mode

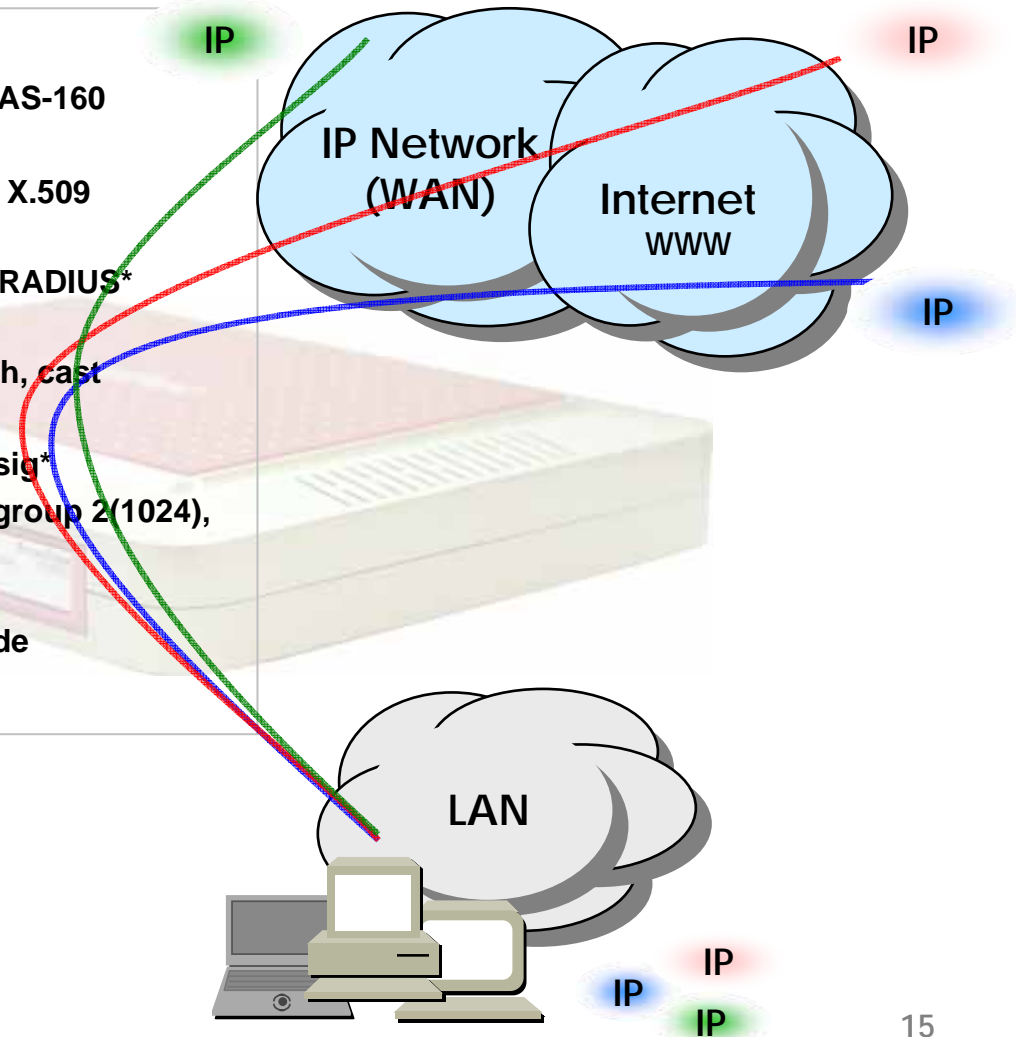

AP600S VoVPN Gateway Product Overview

VPN Protocols

• VPN Protocols

- IPSec Protocol : AH(Authentication Header), ESP
- IPSec mode : Transport mode, Tunnel mode
- IPSec Encryption : DES, 3DES, AES, blowfish, cast, null
- IPSec Authentication : hmac-md5, hmac-sha1
- PFS : group1, group2, group5
- IPSec lifetime : Second/Byte, Compression LZS, deflate
- CA : CA Server, SCEP, OCSP
- VPN tunnel Monitoring, Prevent Replay Attack
- NAT-Traversal: IPSec Communication in NAT Environment without L2TP

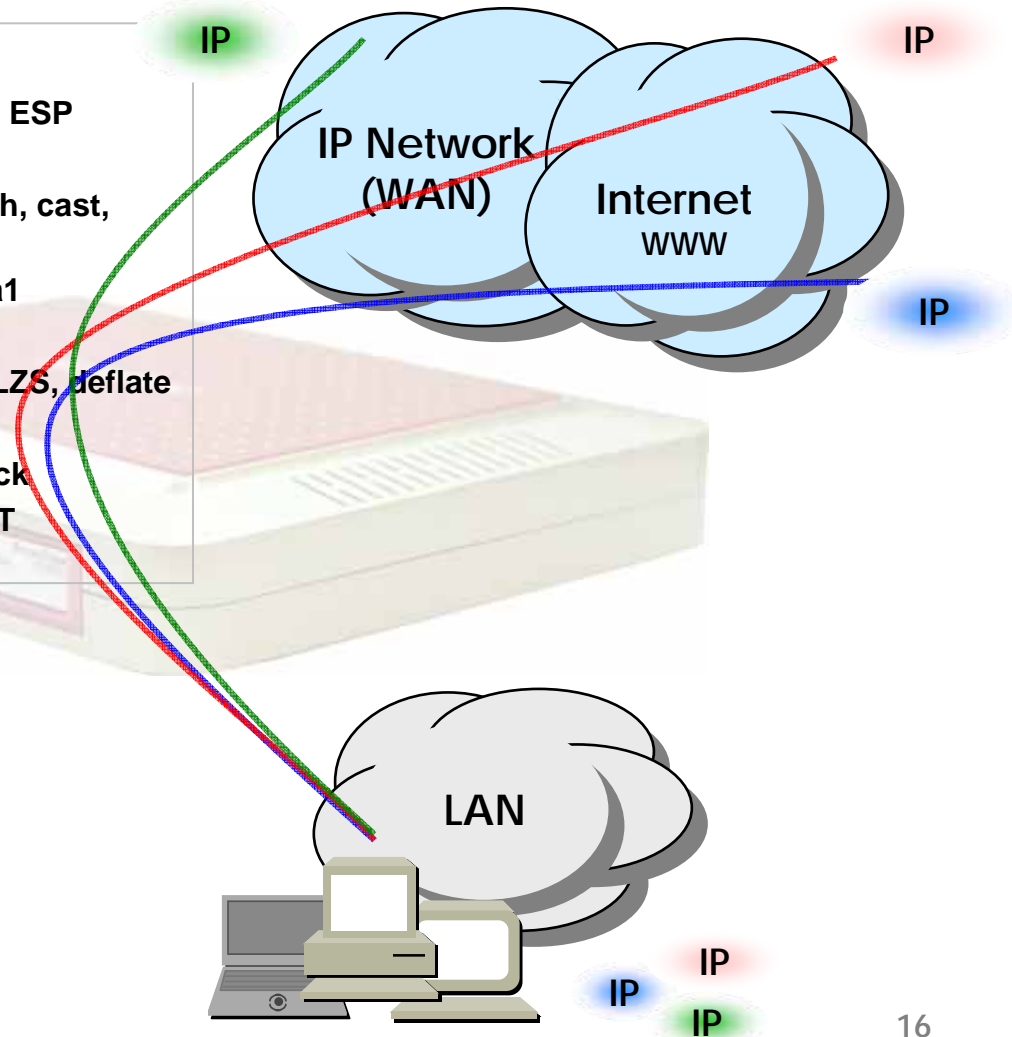

AP600S VoVPN Gateway Product Overview

Network Managements

- **SNMP**

- Standard Simple Network Management Protocol(SNMP) Agent support
- MIB v1 and v2 Support

- **Web-based Management**

- Standard Voice Interface
- Standard PSTN Back-up Interface(optional)

- **Watch-dog Function**

- Hardware, Software watch-dog services

- **Remote Management**

- Telnet
- Rlogin
- Console

- **Auto Upgrade Service**

- HTTP server based APOS image and configuration file auto-upgrade support

- **Batch Job Function**

- Text based script downloading

- **Easy Set-up Service**

- MS Windows Graphical User Interface (GUI) based installation Software Solution
- Easy installation Set-up service

- **Interoperable with AP-VPMS Service**

- AddPac VoIP Plug & Play Management System (AP-VPMS)

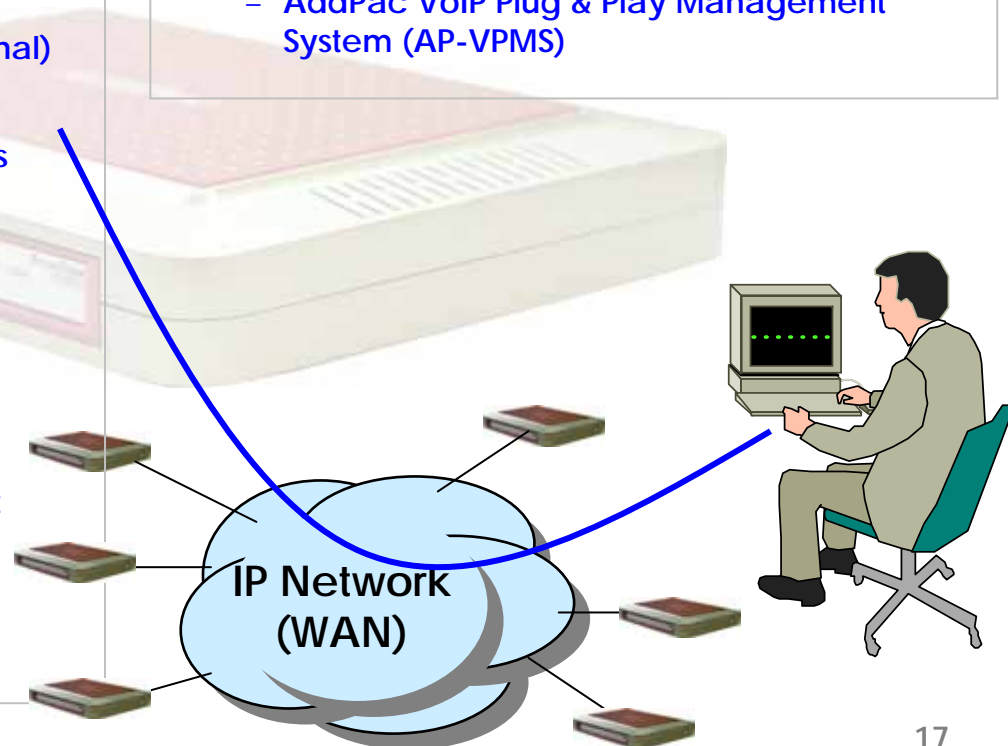

AP600S VoVPN Gateway Product Overview

Security Managements

- IP packet filtering
- IP access list
- User authentication function
 - Password Authentication Protocol (PAP)
 - Challenge Handshake Authentication Protocol (CHAP)
- Enable/Disable specific protocols
- Auto-square connect of console and Telnet session
- Account Management function for multi-level user
- SNMP/TELNET/FTP/HTTP/TFTP port assignment function
- SNMP/TELNET/FTP access list management
- Boot mode security checking function

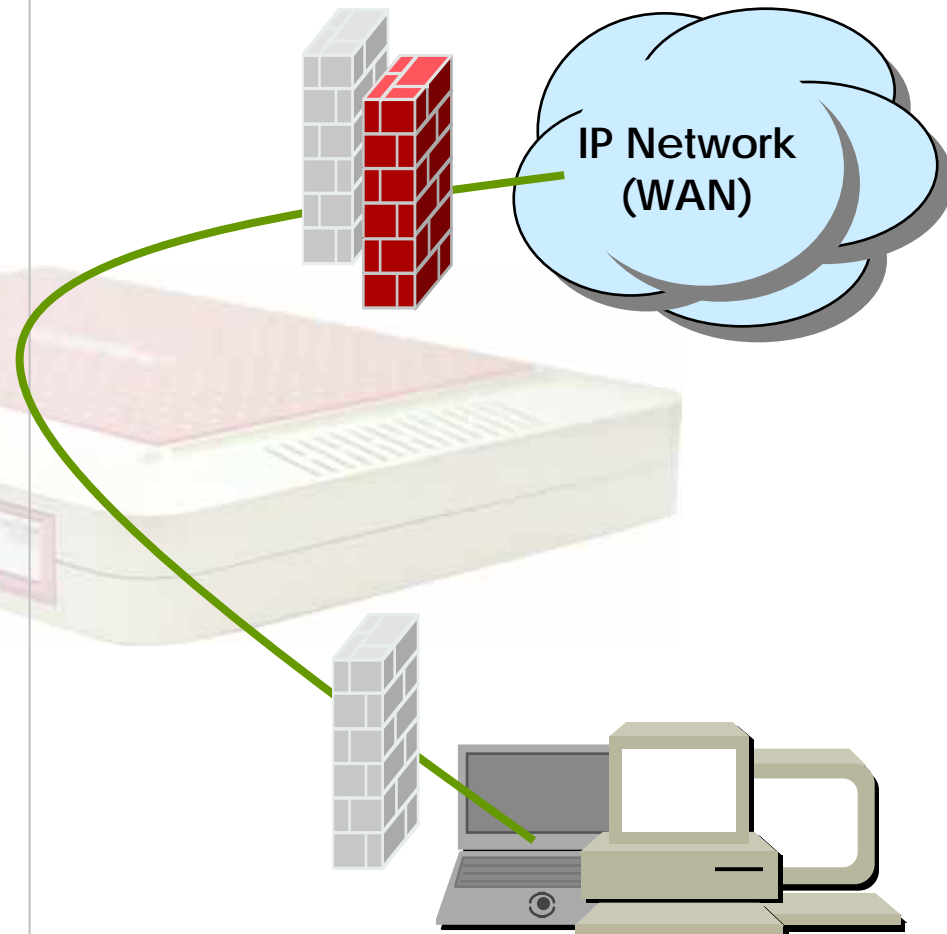

AP600S VoVPN Gateway Product Overview

Network Scalability

- IP Sharing Feature

- Single IP Address, Multiple IP Network Access
- Public IP Address Sharing by VoIP Gateway

- IP Sharing Network Environment

- Support Legacy Network Environment
- xDSL Modem based Broadband Network
- Cable Modem based Broadband Network
- Leased line Network Environment

- Both support Fixed and Dynamic IP

- Support Standard Network Protocols

- PPPoE
- PPTP
- DHCP



AP600S VoIP Gateway

- Cascade(Stacking) Function

- Single Public IP address with stacking multiple VoIP Gateways(virtual ports expansion)

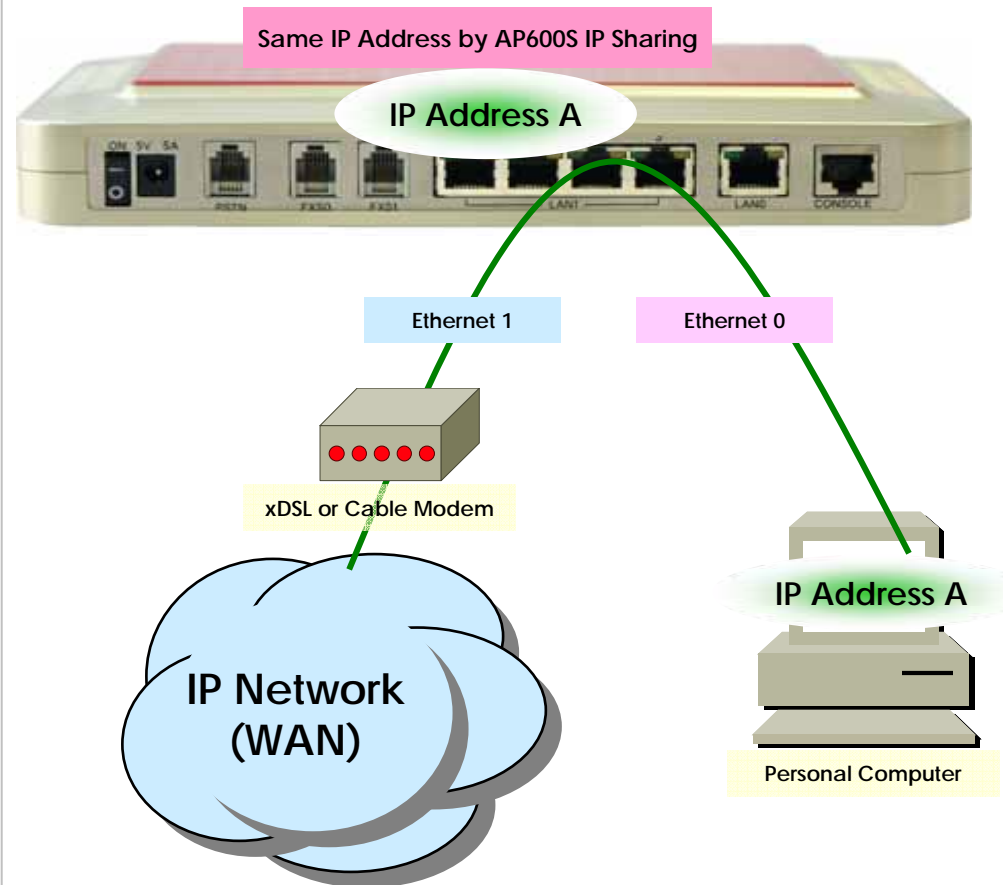

AP600S VoVPN Gateway Product Overview

Network Scalability (cont.)

- Bridging Service
 - Spanning Tree Bridging protocol (IEEE) support
- DHCP
 - Server and Relay
- IP Accounting
- PAT (Port Address Translation)
- NAT (Network Address Translation)
- Cisco Style CLI (Command Line Interface)
- PPTP (Point-to-Point Tunneling Protocol)
- NTP (Network Time Protocol)
- FTP/TFTP
 - Server and Client support
- DNS
 - Dynamic DNS Client support

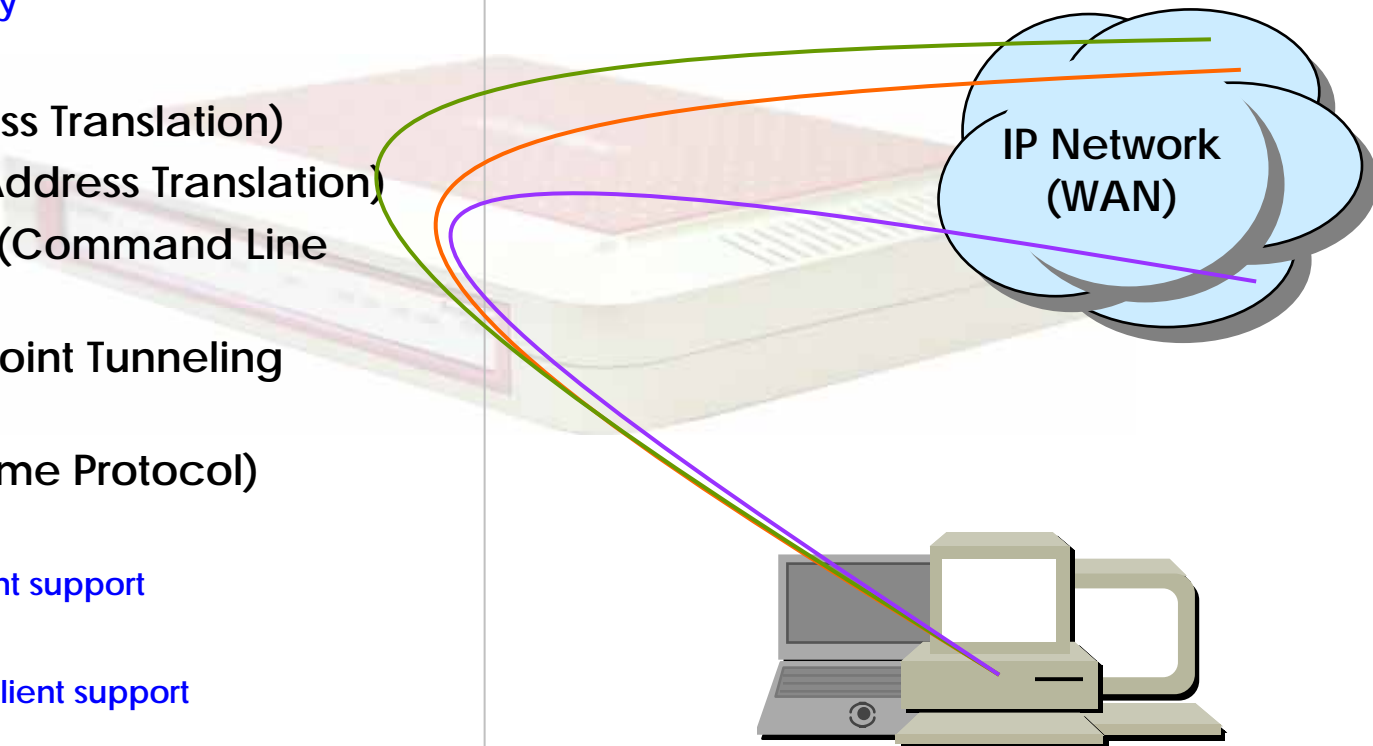

AP600S VoVPN Gateway Product Overview

VoIP Plug & Play System (VPMS)

- **AddPac AP-VPMS Support**
 - AddPac VoIP Plug & Play System (VPMS)
 - Best EMS Solutions for AddPac VoIP G/W
- **Requirements Hardware Platform**
 - Over 1GHz Intel Pentium 4 Machine
 - Over 1GB Main Memory
 - Over 40GB Hard Disk Memory
 - Microsoft Windows Advanced Server or Windows 2000 Server or Windows XP Professional
 - DBMS : Microsoft MS-SQL Server 2000

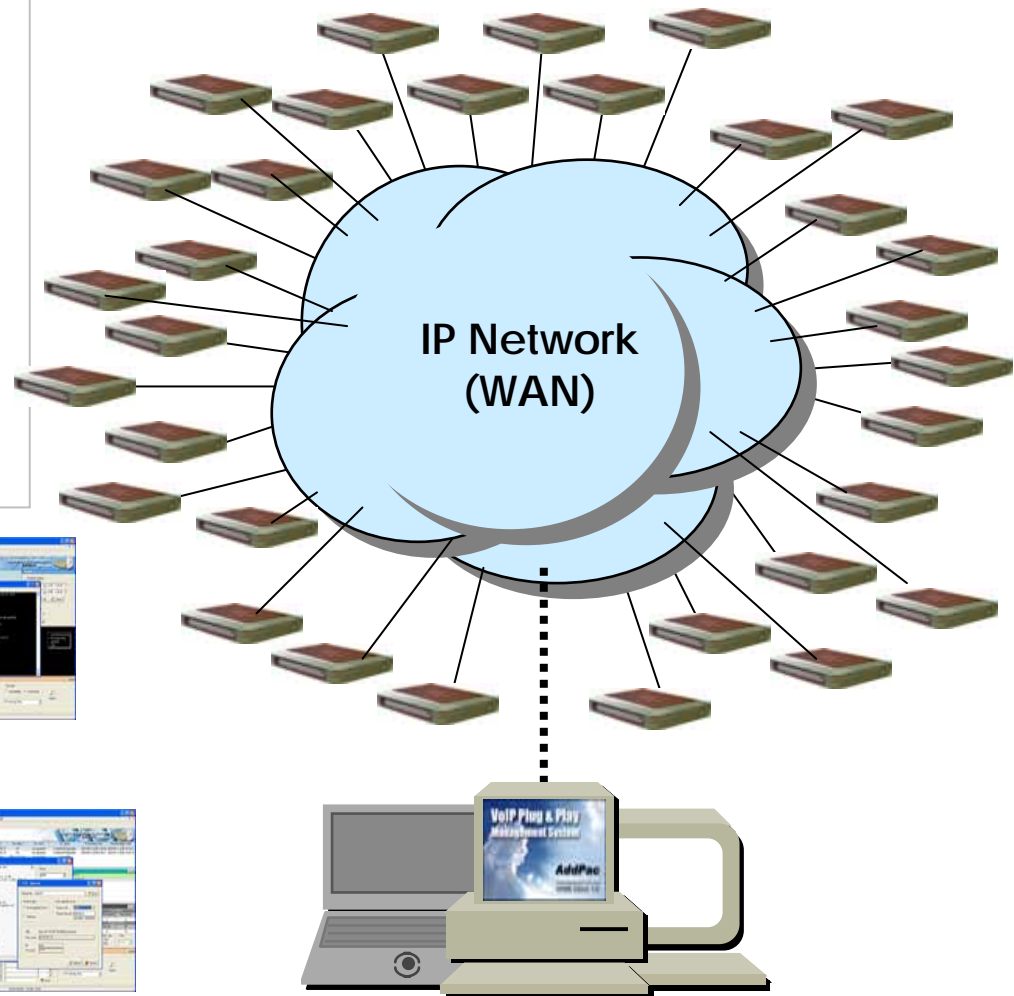

AP600S VoVPN Gateway Product Overview

AP600S Hardware Specification

Hardware Specifications

AP600S VoIP Series	Basic Specifications
CPU	High Performance RISC Microprocessor
Voice Interface	2-Ports FXS Voice Interface(RJ-11)
Ethernet Interface	1-Port 10/100Mbps Ethernet Interface(RJ-45)
	4-Port 10/100Mbps Ethernet Interface(RJ-45)
Console Port	1-Port RS-232C Console Port(RJ-45)
PSTN Backup Port	1-Port PSTN Backup Port(RJ-11)
Boot Memory	512Kbyte Flash Memory
Flash Memory	8Mbyte High-speed Flash Memory
Security Accelerator	Optional VPN Accelerator
Base Memory	64Mbyte High-speed SDRAM
Power Requirement	External Power Supply Adaptor / VAC 110~220V, 50/60Hz, 25Watt
Operating Temperature	0°C ~ 45°C (32 °F ~ 122°F)
Storage Temperature	-40°C ~ 85°C (-40°C ~ 185°F)
Relative Humidity	5% ~ 95% (Non-condensing)
Dimensions	43mm x 265mm x 165mm (H x W x D)

Network interface Configurations

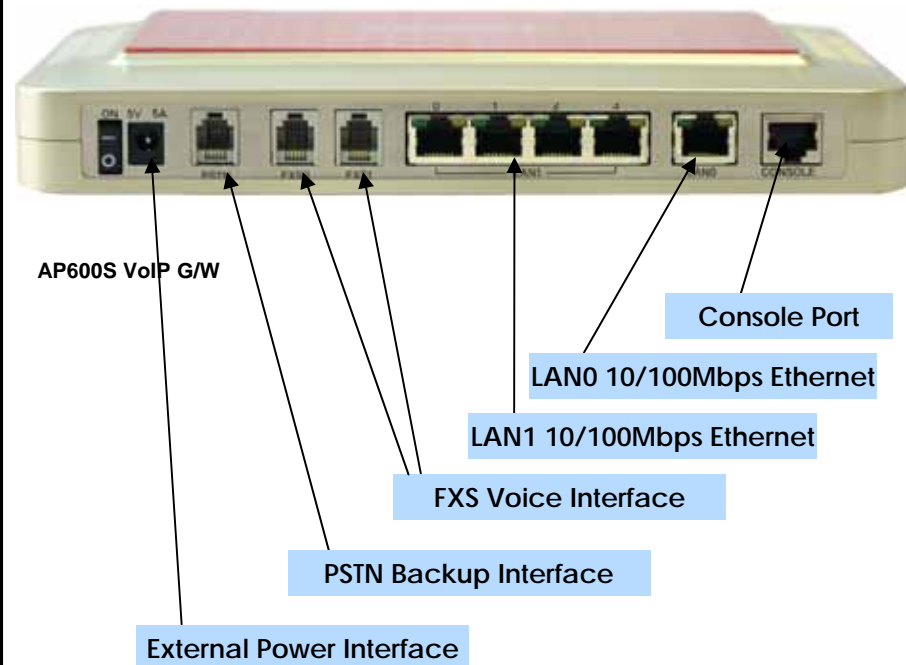



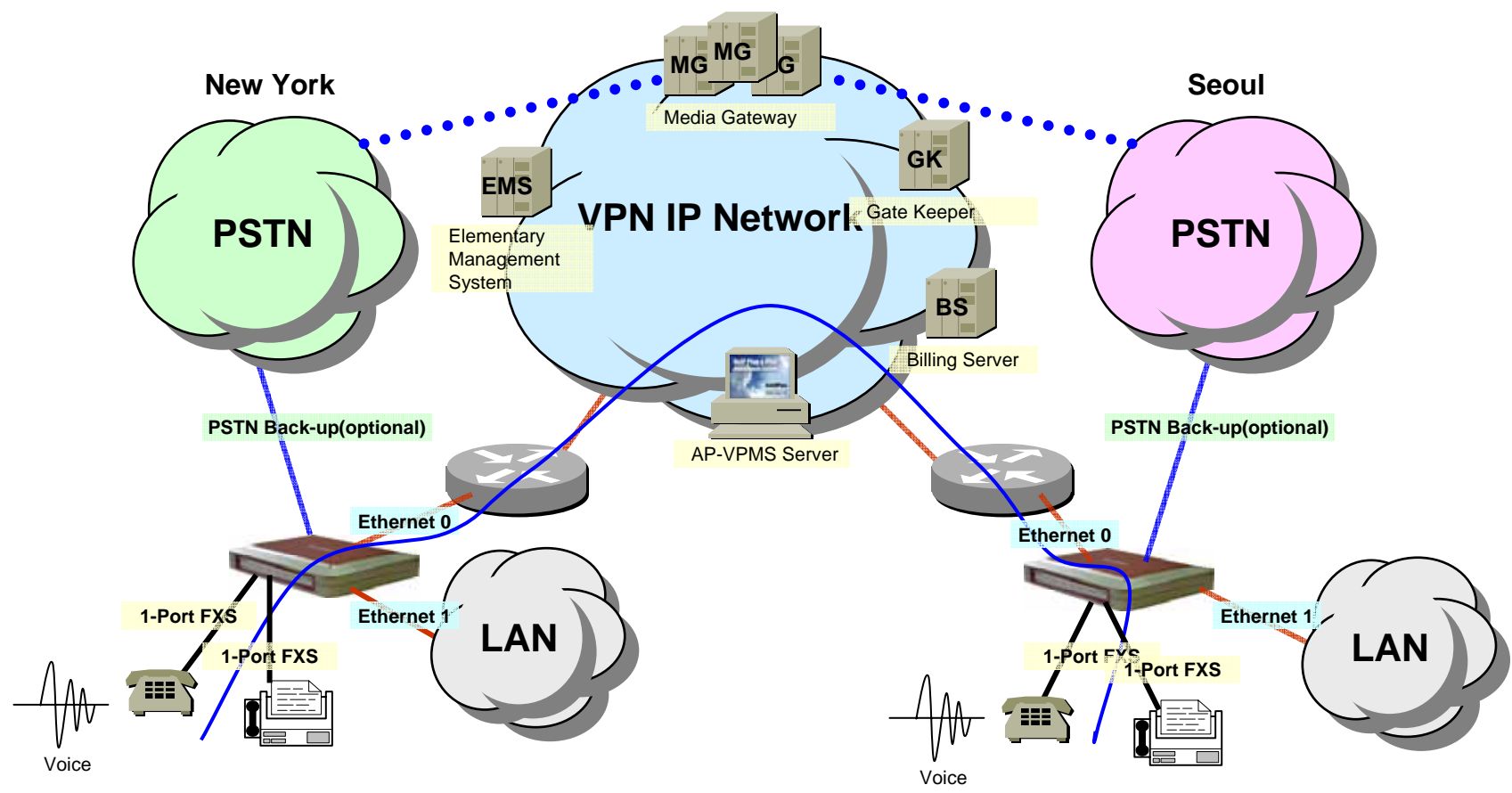

AP600S Voice over IP-VPN Networking



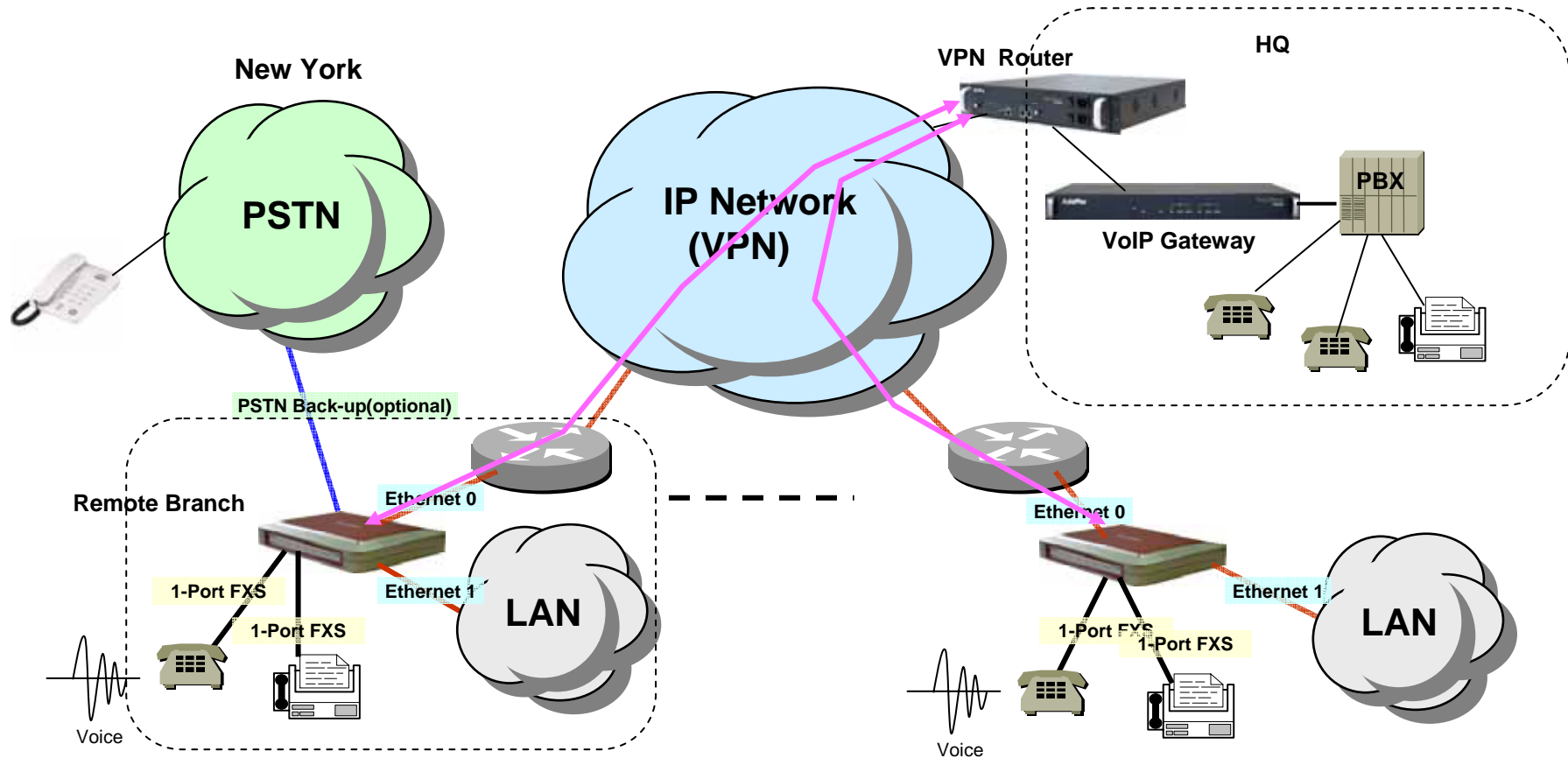

-  FXS Analog Voice Interface
-  FXO Analog Voice Interface
-  Voice+Data, Ethernet or WAN Interface
-  TRUNK n x E1 Voice Interface for PSTN Interworking
-  Leased Line/ATM/Frame-Relay/IP Router, xDSL/Cable Modem, etc.
-  AddPac AP600S VoVPN Gateway
-  Analog Phone

AP600S Voice over IP-VPN Network



-  FXS Analog Voice Interface
-  FXO Analog Voice Interface
-  Voice+Data, Ethernet or WAN Interface
-  TRUNK n x E1 Voice Interface for PSTN Interworking

-  Leased Line/ATM/Frame-Relay/IP Router, xDSL/Cable Modem, etc.
-  AddPac AP600S VoVPN Gateway
-  Analog Phone

AP600S VoIP Gateway Product Overview

AddPac World-Wide Customer Site

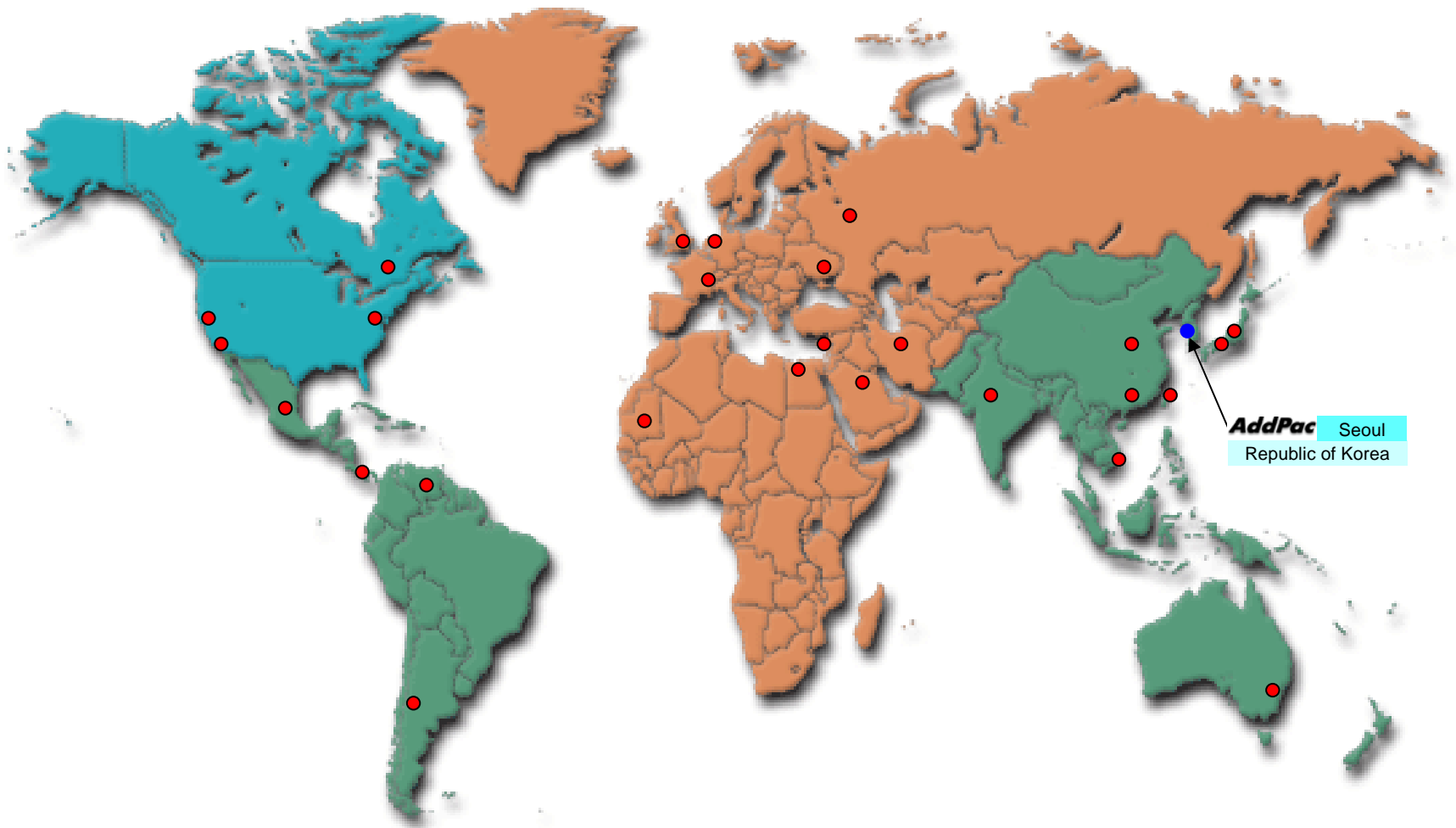

AP600S Gateway Product Overview

AP600S Ordering and Pricing

- **AP600S VoIP Gateway Series**

- VoVPN Gateway Hardware

- High Performance RISC CPU
- 2-Port FXS Voice port Configuration
- 1-Port 10/100BaseT Ethernet for WAN
- 4-Ports 10/100BaseT Ethernet Interface for LAN
- 1-Port PSTN Back-up
- 1-Port RS-232C Console
- Including Network Cable Set
- **Optional VPN Security Accelerator**

- Built-in APOS Internetworking Software

- Including 1-Year Hardware Warranty

- Product Documents

- Installation Guide (PDF)
- Quick APOS Operation Guide (PDF)
- APOS Operation Guide (PDF)

- **Pricing**

- AddPac Technology Regional Sales Managers

- Authorized Sales and Marketing Representatives

- Please Contact www.addpac.com



OEM and volume
pricing available!

AddPac Technology Co., Ltd.

Thank you !

www.addpac.com

Technical Sales and Marketing

AddPac Technology

sales@addpac.com